

## Features

- Power Supply Range:
  - Signal Supply : 3V to 20V
  - Dual Supply :  $\pm 1.5V$  to  $\pm 10V$
- Large DC Voltage Gain : 100dB
- Large Output Swing :  $0V \sim V_{DD} - 1.5V$
- Bandwidth(unity gain) : 2MHz
- Internally Frequency Compensated for Unity Gain
- Low Input Offset Voltage : 1mV
- Lead Free Available (RoHS Compliant)

## Applications

- Amplifiers
- Filters
- Analog Circuit

## General Description

The JRC4558 consists of two independent, high gain, internally frequency compensated operational amplifiers which were designed specifically to operate from a single power supply up to 20 volts. Operation from dual power supplies is also possible and the power supply current drain is essentially independent of the magnitude of the power supply voltage.

Application areas include transducer amplifiers, DC gain blocks and all the conventional OP amplifier circuits which can be more easily implemented in single power supply systems. (For example, the JRC4558 can be directly operated from the standard +5V power supply voltage which is normally used in digital systems).

Block Diagram

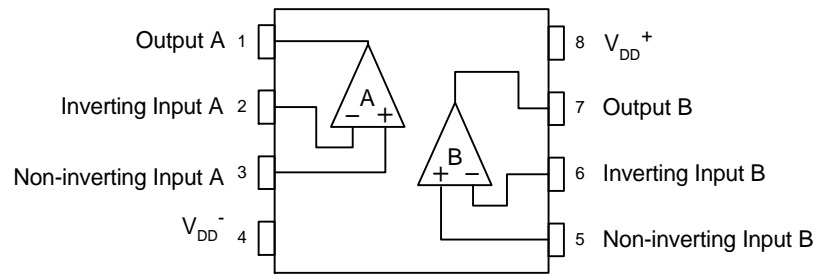

Absolute Maximum Ratings ( $T_A = 25^{\circ}\text{C}$ )

Symbol	Parameter	Rating	Unit
$V_{DD}$	Supply Voltage	20	V
$V_{ID}$	Differential Input Voltage	20	V
$V_I$	Input Voltage	-0.3V to +20V	V
$P_D$	Power Dissipation	500	mW
$T_A$	Operating Free-air Temperature Range	0 to 70	$^{\circ}\text{C}$
$T_{STG}$	Storage Temperature Range	-40 to +150	$^{\circ}\text{C}$

Electrical Characteristics ( $V_{DD} = \pm 10\text{V}$ ,  $T_A = 25^{\circ}\text{C}$ )

Symbol	Parameter	Test Conditions	JRC4558			Unit
			Min.	Typ.	Max.	
$V_{IO}$	Input Offset Voltage	$R_S \leq 10\text{k}\Omega$		1	6	mV
$I_{IO}$	Input Offset Current			5	200	nA
$I_{BIAS}$	Input Bias Current			25	500	nA
$R_{IN}$	Input Resistance		0.3	5		$\text{M}\Omega$
$A_V$	Large Signal Voltage Gain	$R_L \geq 2\text{k}\Omega$ , $V_O = \pm 10\text{V}$	86	100		dB
$V_{OM1}$	Maximum Output Voltage Swing 1	$R_L \geq 10\text{k}\Omega$	$\pm 9$	$\pm 9.5$		V
$V_{OM2}$	Maximum Output Voltage Swing 2	$R_L \geq 2\text{k}\Omega$	$\pm 8.5$	$\pm 9.0$		V
$V_{ICM}$	Input Common-Mode Voltage Range		$\pm 9$	$\pm 9.5$		V
CMRR	Common-Mode Rejection Ratio	$R_S \leq 10\text{k}\Omega$		90		dB
SVRR	Supply Voltage Rejection Ratio	$R_S \leq 10\text{k}\Omega$ , $V_{P-P} = 100\text{mV}$ , $f_{IN} = 100\text{HZ}$	60	65		dB
$I_{CC}$	Operating Current			3.7	6	mA
$V_{NI}$	Equivalent Input Noise Voltage	RIAA, $R_S = 1\text{k}\Omega$ , 30kHz, LPF		1.4		$\mu\text{Vrms}$
SR	Slew Rate			650		$\text{mV}/\mu\text{s}$
GBWP	Gain Bandwidth Product			2		MHz

Typical Characteristics

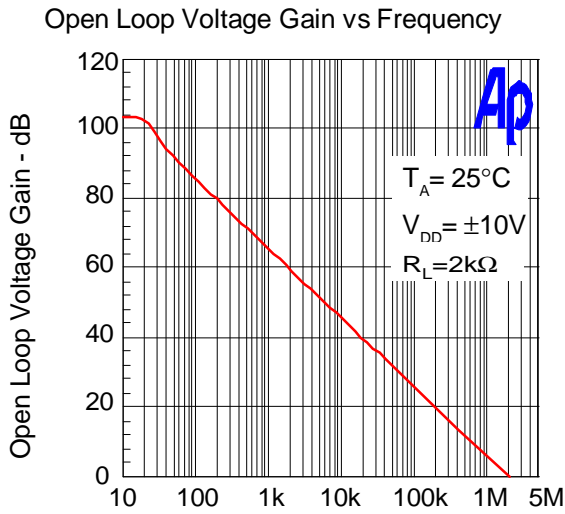

Figure 1 : Frequency (Hz)

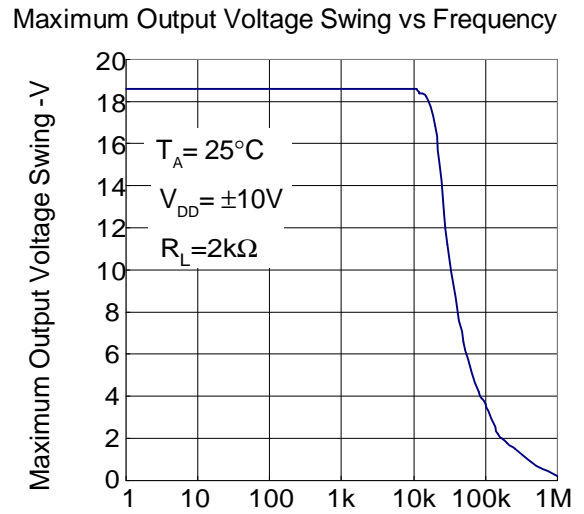

Figure 2 : Frequency (Hz)

Maximum Output Voltage Swing vs Load Resistance

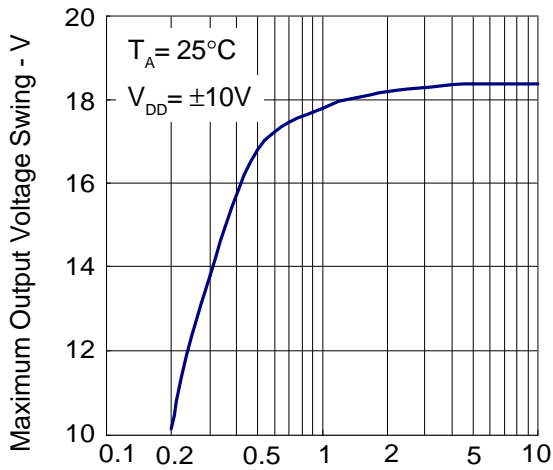

Figure 3 : Load Resistance -  $\text{k}\Omega$

Operating Current vs Temperature

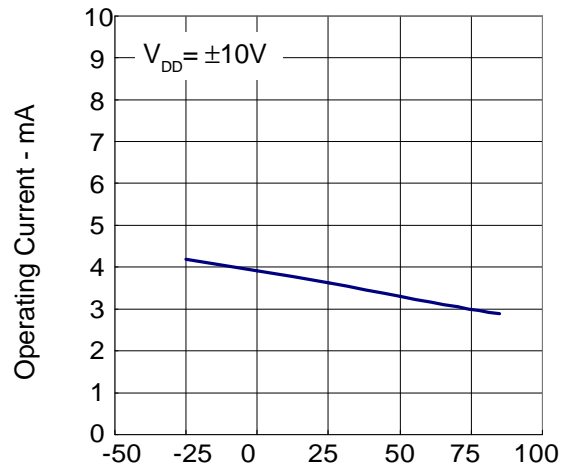

Figure 4 : Temperature -  $^\circ\text{C}$

Typical Characteristics Cont.

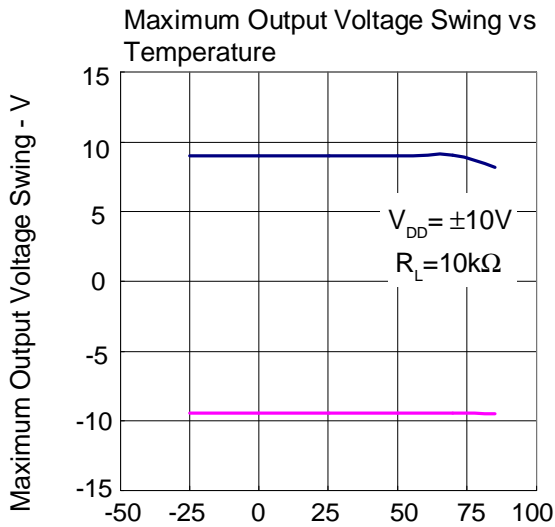

Figure 5 : Temperature - °C

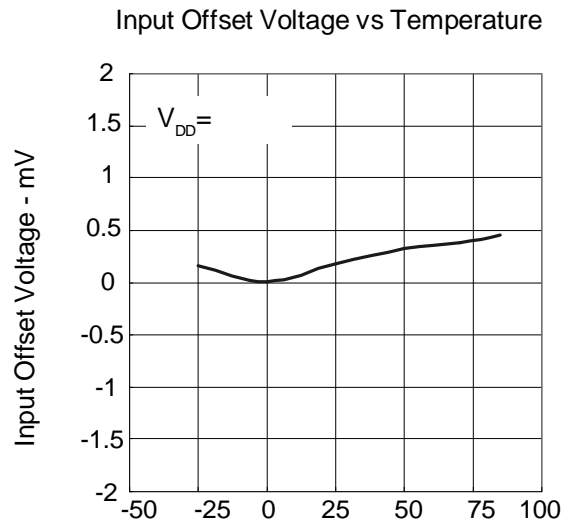

Figure 6 : Temperature - °C

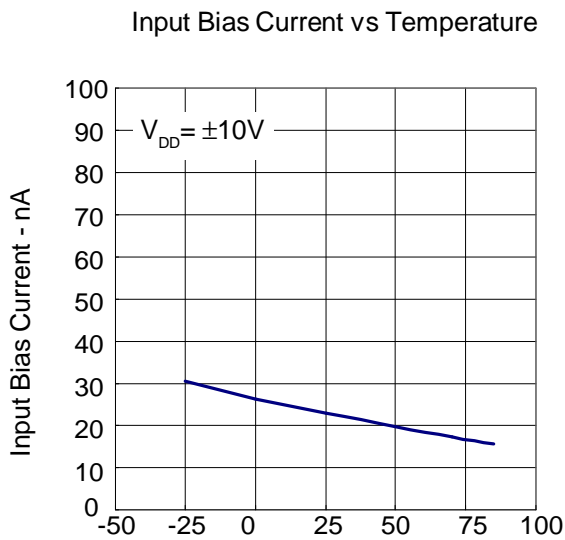

Figure 7 : Temperature - °C

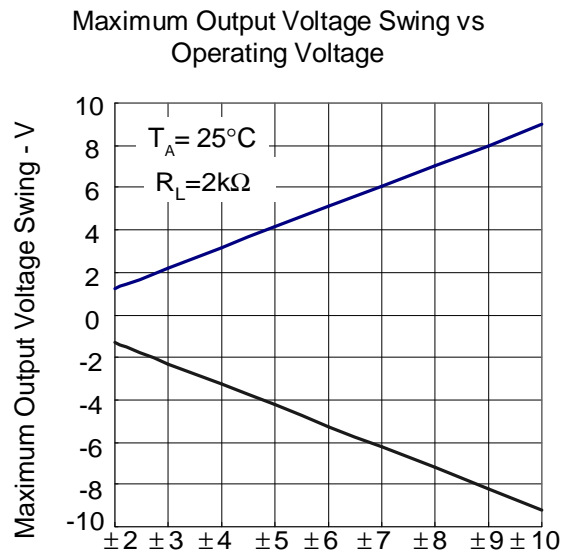

Figure 8 : Operating Voltage - V

Typical Characteristics Cont.

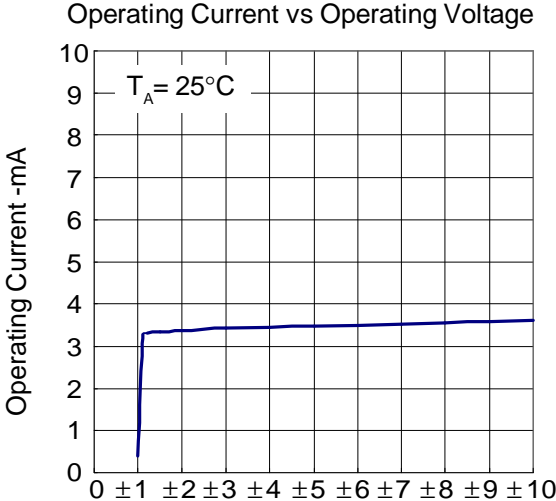

Figure 8 : Operating Voltage - V

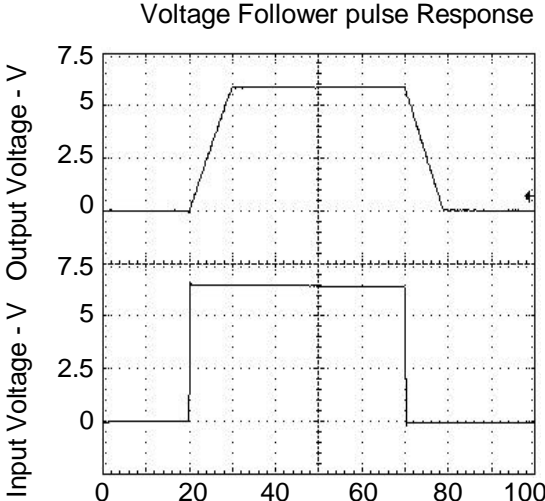
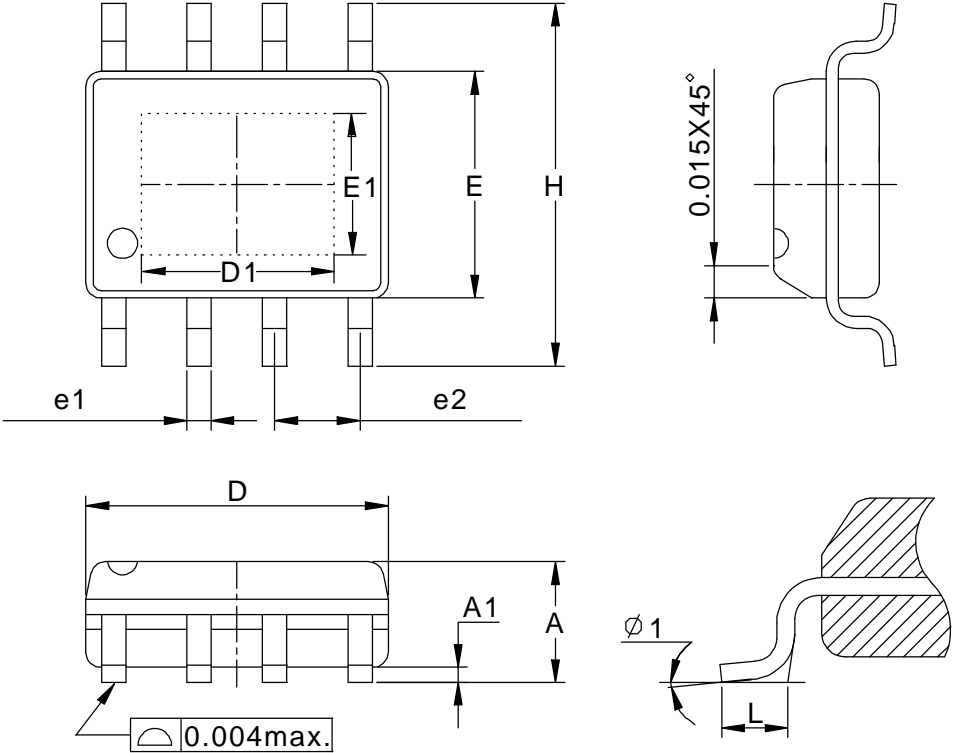

Figure 9 : Time -  $\mu\text{s}$

Packaging Information

SOP-8-P pin ( Reference JEDEC Registration MS-012)



Dim	Millimeters		Inches	
	Min.	Max.	Min.	Max.
A	1.35	1.75	0.053	0.069
A1	0	0.15	0	0.006
D	4.80	5.00	0.189	0.197
D1	3.00REF		0.118REF	
E	3.80	4.00	0.150	0.157
E1	2.60REF		0.102REF	
H	5.80	6.20	0.228	0.244
L	0.40	1.27	0.016	0.050
e1	0.33	0.51	0.013	0.020
e2	1.27BSC		0.50BSC	
$\phi 1$	8°		8°	

Packaging Information

TSSOP-8

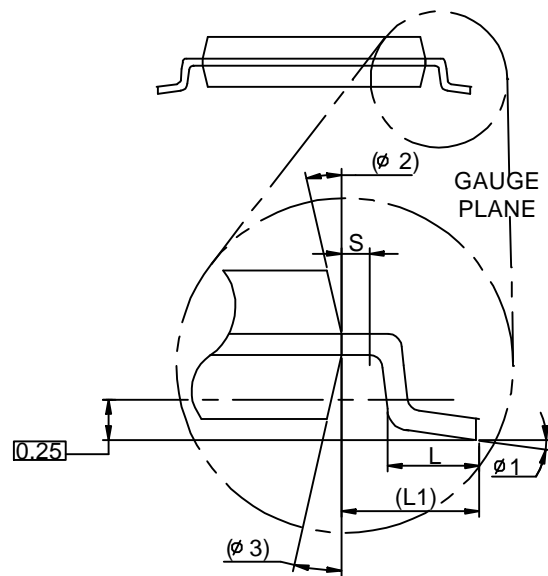
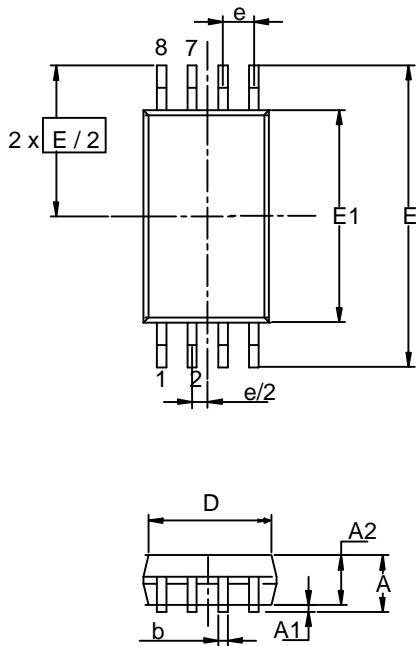

Dim	Millimeters		Inches	
	Min.	Max.	Min.	Max.
A		1.2		0.047
A1	0.00	0.15	0.000	0.006
A2	0.80	1.05	0.031	0.041
b	0.19	0.30	0.007	0.012
D	2.9	3.1	0.114	0.122
e	0.65 BSC		0.026 BSC	
E	6.40 BSC		0.252 BSC	
E1	4.30	4.50	0.169	0.177
L	0.45	0.75	0.018	0.030
L1	1.0 REF		0.039 REF	
R	0.09		0.004	
R1	0.09		0.004	
S	0.2		0.008	
$\phi 1$	0°	8°	0°	8°
$\phi 2$	12° REF		12° REF	
$\phi 3$	12° REF		12° REF	

Packaging Information

PDIP-8 pin ( Reference JEDEC Registration MS-001)

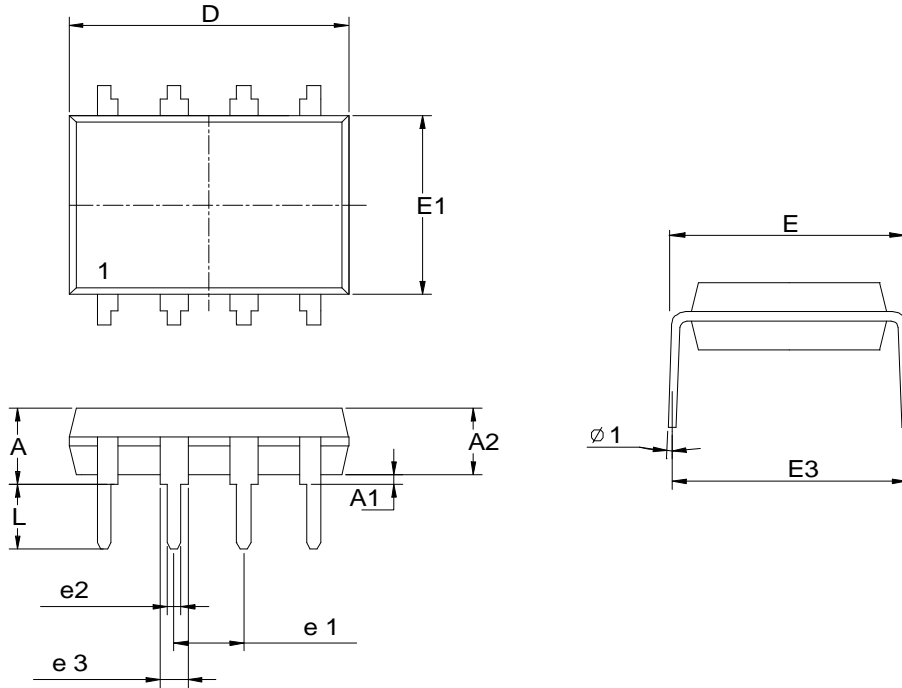

Dim	Millimeters		Inches	
	Min.	Max.	Min.	Max.
A		5.33		0.210
A1	0.38		0.015	
A2	2.92	3.68	0.115	0.145
D	9.02	10.16	0.355	0.400
e1	2.54 BSC		0.100 BSC	
e2	0.36	0.56	0.014	0.022
e3	1.14	1.78	0.045	0.070
E	7.62 BSC		0.300 BSC	
E1	6.10	7.11	0.240	0.280
E3		10.92		0.430
L	2.92	3.81	0.115	0.150
φ1	15° REF		15° REF	



Physical Specifications

Terminal Material	Solder-Plated Copper (Solder Material : 90/10 or 63/37 SnPb), 100%Sn
Lead Solderability	Meets EIA Specification RSI86-91, ANSI/J-STD-002 Category 3.

Reflow Condition (IR/Convection or VPR Reflow)

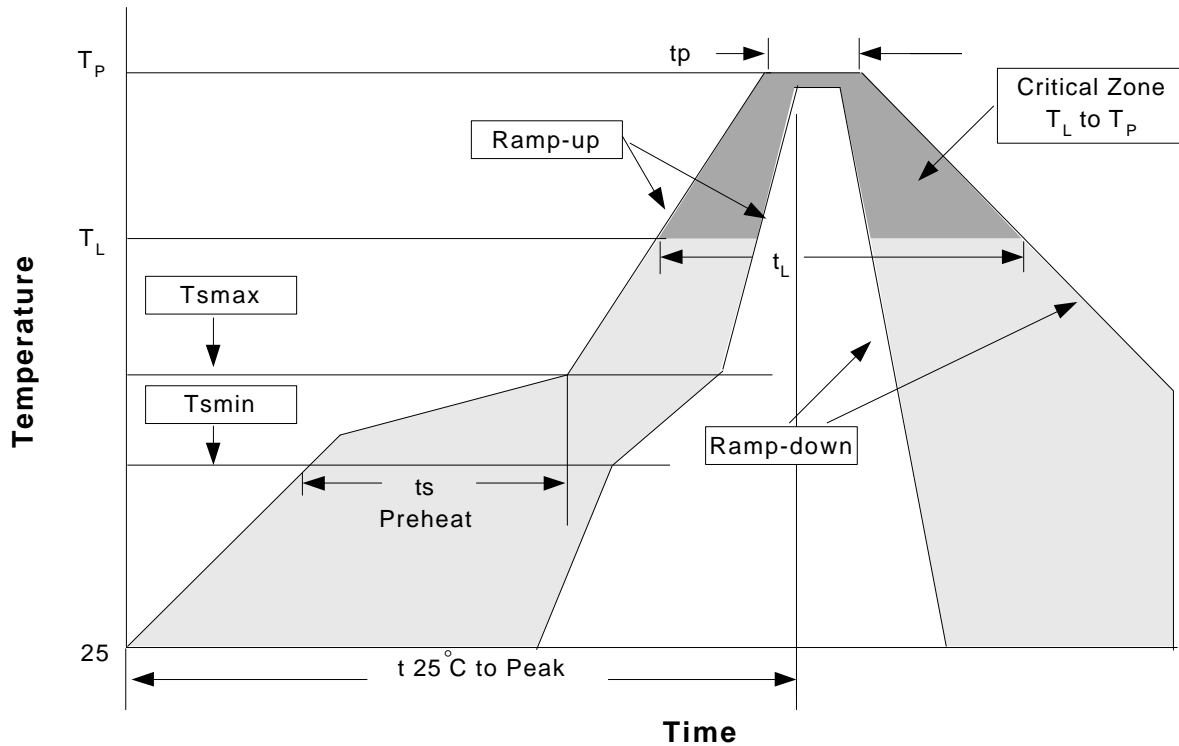

Classification Reflow Profiles

Profile Feature	Sn-Pb Eutectic Assembly	Pb-Free Assembly
Average ramp-up rate (T <sub>L</sub> to T <sub>P</sub> )	3°C/second max.	3°C/second max.
Preheat		
- Temperature Min (T <sub>min</sub> )	100°C	150°C
- Temperature Max (T <sub>max</sub> )	150°C	200°C
- Time (min to max) (t <sub>s</sub> )	60-120 seconds	60-180 seconds
Time maintained above:		
- Temperature (T <sub>L</sub> )	183°C	217°C
- Time (t <sub>L</sub> )	60-150 seconds	60-150 seconds
Peak/Classification Temperature (T <sub>p</sub> )	See table 1	See table 2
Time within 5°C of actual Peak Temperature (t <sub>p</sub> )	10-30 seconds	20-40 seconds
Ramp-down Rate	6°C/second max.	6°C/second max.
Time 25°C to Peak Temperature	6 minutes max.	8 minutes max.

Notes: All temperatures refer to topside of the package .Measured on the body surface.