

## JW050A, JW075A, JW100A, JW150A Power Modules: dc-dc Converters; 36 to 75 Vdc Input, 5 Vdc Output; 50 W to 150 W

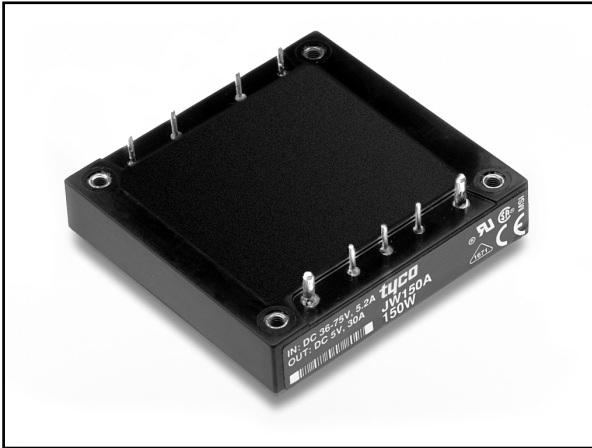

The JW050A, JW075A, JW100A, and JW150A Power Modules use advanced, surface-mount technology and deliver high-quality, efficient, and compact dc-dc conversion.

### Applications

- Distributed power architectures
- Workstations
- Computer equipment
- Communications equipment

### Options

- Heat sinks available for extended operation
- Choice of remote on/off logic configuration

### Description

The JW050A, JW075A, JW100A, and JW150A Power Modules are dc-dc converters that operate over an input voltage range of 36 Vdc to 75 Vdc and provide a precisely regulated dc output. The outputs are fully isolated from the inputs, allowing versatile polarity configurations and grounding connections. The modules have maximum power ratings from 50 W to 150 W at a typical full-load efficiency of 84%.

The sealed modules offer a metal baseplate for excellent thermal performance. Threaded-through holes are provided to allow easy mounting or addition of a heat sink for high-temperature applications. The standard feature set includes remote sensing, output trim, and remote on/off for convenient flexibility in distributed power applications.

### Features

- Small size: 61.0 mm x 57.9 mm x 12.7 mm (2.40 in. x 2.28 in. x 0.50 in.)
- High power density
- High efficiency: 84% typical
- Low output noise
- Constant frequency
- Industry-standard pinout
- Metal baseplate
- 2:1 input voltage range
- Overtemperature protection (100 W and 150 W only)
- Overcurrent and overvoltage protection
- Remote sense
- Remote on/off
- Adjustable output voltage: 60% to 110% of  $V_{O, nom}$
- Case ground pin
- ISO9001 Certified manufacturing facilities
- UL\* 1950 Recognized, CSA† C22.2 No. 950-95 Certified, and VDE 0805 (EN60950, IEC950) Licensed
- CE mark meets 73/23/EEC and 93/68/EEC directives‡

\* UL is a registered trademark of Underwriters Laboratories, Inc.

† CSA is a registered trademark of Canadian Standards Assn.

‡ This product is intended for integration into end-use equipment. All the required procedures for CE marking of end-use equipment should be followed. (The CE mark is placed on selected products.)

## Absolute Maximum Ratings

Stresses in excess of the absolute maximum ratings can cause permanent damage to the device. These are absolute stress ratings only. Functional operation of the device is not implied at these or any other conditions in excess of those given in the operations sections of the data sheet. Exposure to absolute maximum ratings for extended periods can adversely affect device reliability.

Parameter	Symbol	Min	Max	Unit
Input Voltage:				
Continuous:				
JW050A, JW075A	$V_I$	—	75	Vdc
JW100A, JW150A	$V_I$	—	80	Vdc
Transient (100 ms; JW100A, JW150A only)	$V_{I, trans}$	—	100	V
I/O Isolation Voltage (for 1 minute)	—	—	1500	Vdc
Operating Case Temperature (See Thermal Considerations section.)	$T_C$	-40	100	°C
Storage Temperature	$T_{stg}$	-55	125	°C

## Electrical Specifications

Unless otherwise indicated, specifications apply over all operating input voltage, resistive load, and temperature conditions.

**Table 1. Input Specifications**

Parameter	Symbol	Min	Typ	Max	Unit
Operating Input Voltage	$V_I$	36	48	75	Vdc
Maximum Input Current ( $V_I = 0\text{ V to }75\text{ V}$ ; $I_O = I_{O, max}$ ):					
JW050A (See Figure 1.)	$I_{I, max}$	—	—	1.7	A
JW075A (See Figure 2.)	$I_{I, max}$	—	—	2.6	A
JW100A (See Figure 3.)	$I_{I, max}$	—	—	3.5	A
JW150A (See Figure 4.)	$I_{I, max}$	—	—	5.2	A
Inrush Transient	$i^2t$	—	—	1.0	A <sup>2</sup> s
Input Reflected-ripple Current, Peak-to-peak (5 Hz to 20 MHz, 12 $\mu$ H source impedance; see Figure 17.)	$I_r$	—	5	—	mAp-p
Input Ripple Rejection (120 Hz)	—	—	60	—	dB

## Fusing Considerations

**CAUTION: This power module is not internally fused. An input line fuse must always be used.**

This encapsulated power module can be used in a wide variety of applications, ranging from simple stand-alone operation to an integrated part of a sophisticated power architecture. To preserve maximum flexibility, internal fusing is not included; however, to achieve maximum safety and system protection, always use an input line fuse. The safety agencies require a normal-blow fuse with a maximum rating of 20 A (see Safety Considerations section). Based on the information provided in this data sheet on inrush energy and maximum dc input current, the same type of fuse with a lower rating can be used. Refer to the fuse manufacturer's data for further information.

## Electrical Specifications (continued)

Table 2. Output Specifications

Parameter	Device	Symbol	Min	Typ	Max	Unit
Output Voltage Set Point ( $V_i = 48\text{ V}$ ; $I_o = I_{o, \text{max}}$ ; $T_c = 25\text{ }^\circ\text{C}$ )	All	$V_{o, \text{set}}$	4.92	5.0	5.08	Vdc
Output Voltage (Over all operating input voltage, resistive load, and temperature conditions until end of life. See Figure 19.)	All	$V_o$	4.85	—	5.15	Vdc
Output Regulation: Line ( $V_i = 36\text{ V}$ to $75\text{ V}$ )	All	—	—	0.01	0.1	% $V_o$
Load ( $I_o = I_{o, \text{min}}$ to $I_{o, \text{max}}$ )	All	—	—	0.05	0.2	% $V_o$
Temperature ( $T_c = -40\text{ }^\circ\text{C}$ to $+100\text{ }^\circ\text{C}$ )	All	—	—	15	50	mV
Output Ripple and Noise Voltage (See Figure 18.):						
RMS	All	—	—	—	40	mVrms
Peak-to-peak (5 Hz to 20 MHz)	All	—	—	—	150	mVp-p
External Load Capacitance	All	—	0	—	*	$\mu\text{F}$
Output Current (At $I_o < I_{o, \text{min}}$ , the modules may exceed output ripple specifications.)	JW050A JW075A JW100A JW150A	$I_o$ $I_o$ $I_o$ $I_o$	0.5 0.5 0.5 0.5	— — — —	10 15 20 30	A A A A
Output Current-limit Inception ( $V_o = 90\%$ of $V_{o, \text{nom}}$ )	JW050A JW075A JW100A JW150A	$I_{o, \text{cli}}$ $I_{o, \text{cli}}$ $I_{o, \text{cli}}$ $I_{o, \text{cli}}$	— — — —	12.0 18.0 23.0 34.5	14 <sup>†</sup> 21 <sup>†</sup> 26 <sup>†</sup> 39 <sup>†</sup>	A A A A
Output Short-circuit Current ( $V_o = 250\text{ mV}$ )	All	—	—	170	—	% $I_{o, \text{max}}$
Efficiency ( $V_i = 48\text{ V}$ ; $I_o = I_{o, \text{max}}$ ; $T_c = 70\text{ }^\circ\text{C}$ )	JW050A JW075A JW100A JW150A	$\eta$ $\eta$ $\eta$ $\eta$	— — — —	84 84 84 84	— — — —	% % % %
Switching Frequency	All	—	—	500	—	kHz
Dynamic Response ( $\Delta I_o/\Delta t = 1\text{ A}/10\text{ }\mu\text{s}$ , $V_i = 48\text{ V}$ , $T_c = 25\text{ }^\circ\text{C}$ ; tested with a $10\text{ }\mu\text{F}$ aluminum and a $1.0\text{ }\mu\text{F}$ ceramic capacitor across the load):						
Load Change from $I_o = 50\%$ to $75\%$ of $I_{o, \text{max}}$ :						
Peak Deviation	All	—	—	2	—	% $V_{o, \text{set}}$
Settling Time ( $V_o < 10\%$ of peak deviation)	All	—	—	300	—	$\mu\text{s}$
Load Change from $I_o = 50\%$ to $25\%$ of $I_{o, \text{max}}$ :						
Peak Deviation	All	—	—	2	—	% $V_{o, \text{set}}$
Settling Time ( $V_o < 10\%$ of peak deviation)	All	—	—	300	—	$\mu\text{s}$

\* Consult your sales representative or the factory.

† These are manufacturing test limits. In some situations, results may differ.

## Electrical Specifications (continued)

Table 3. Isolation Specifications

Parameter	Min	Typ	Max	Unit
Isolation Capacitance	—	2500	—	pF
Isolation Resistance	10	—	—	MΩ

## General Specifications

Parameter	Min	Typ	Max	Unit
Calculated MTBF ( $I_o = 80\%$ of $I_{o, max}$ ; $T_c = 40\text{ °C}$ )	2,600,000			hr.
Weight	—	—	100 (3.5)	g (oz.)

## Feature Specifications

Unless otherwise indicated, specifications apply over all operating input voltage, resistive load, and temperature conditions. See Feature Descriptions for additional information.

Parameter	Symbol	Min	Typ	Max	Unit
Remote On/Off Signal Interface ( $V_i = 0\text{ V}$ to $75\text{ V}$ ; open collector or equivalent compatible; signal referenced to $V_i(-)$ terminal; see Figure 20 and Feature Descriptions.): JWxxxA1 Preferred Logic: Logic Low—Module On Logic High—Module Off JWxxxA Optional Logic: Logic Low—Module Off Logic High—Module On Logic Low: At $I_{on/off} = 1.0\text{ mA}$ At $V_{on/off} = 0.0\text{ V}$ Logic High: At $I_{on/off} = 0.0\text{ }\mu\text{A}$ Leakage Current Turn-on Time (See Figure 16.) ( $I_o = 80\%$ of $I_{o, max}$ ; $V_o$ within $\pm 1\%$ of steady state)	$V_{on/off}$ $I_{on/off}$ $V_{on/off}$ $I_{on/off}$ —	0 — — — —	— — — — 20	1.2 1.0 15 50 35	V mA V $\mu\text{A}$ ms
Output Voltage Adjustment (See Feature Descriptions.): Output Voltage Remote-sense Range Output Voltage Set-point Adjustment Range (trim)	— —	— 60	— —	0.5 110	V $\%V_{O, nom}$
Output Overvoltage Protection	$V_{O, clamp}$	5.9*	—	7.0*	V
Overtemperature Protection (shutdown) (100 W and 150 W only; see Feature Descriptions.)	$T_c$	—	105	—	$^{\circ}\text{C}$

\* These are manufacturing test limits. In some situations, results may differ.

## Characteristic Curves

The following figures provide typical characteristics for the power modules. The figures are identical for both on/off configurations.

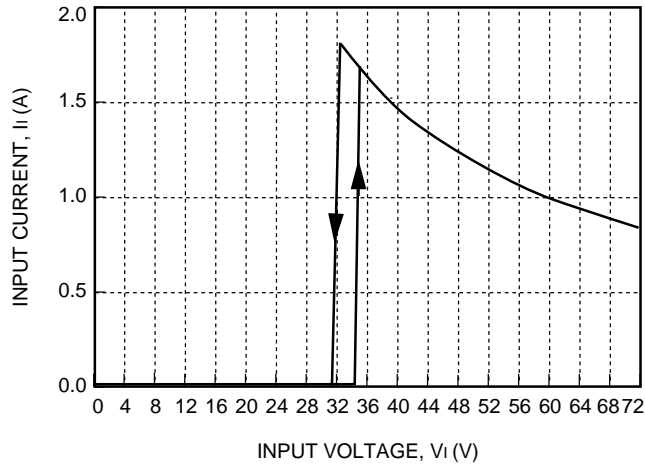

8-1159 (C)

**Figure 1. Typical JW050A Input Characteristics at Room Temperature**

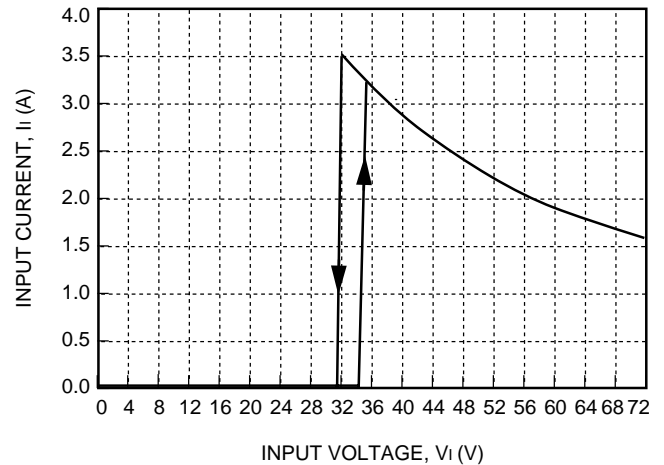

8-1160 (C)

**Figure 3. Typical JW100A Input Characteristics at Room Temperature**

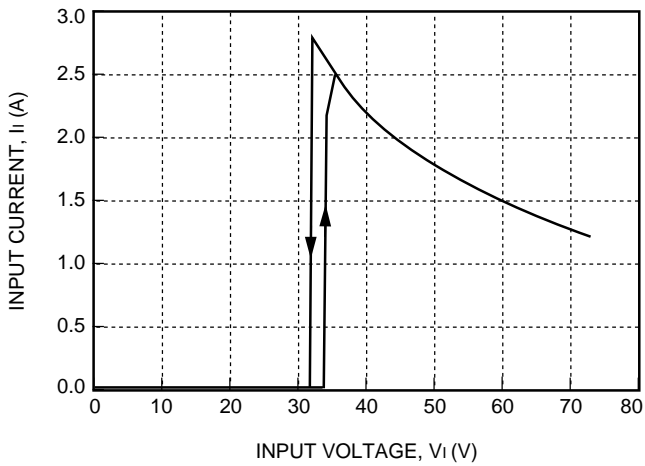

8-1131 (C)

**Figure 2. Typical JW075A Input Characteristics at Room Temperature**

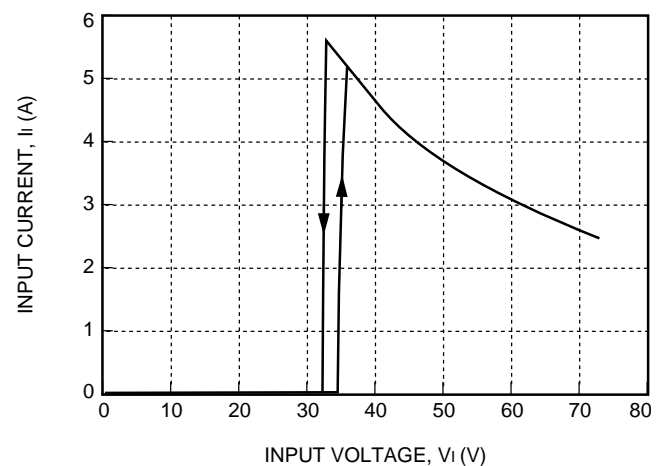

8-1137 (C)

**Figure 4. Typical JW150A Input Characteristics at Room Temperature**

Characteristic Curves (continued)

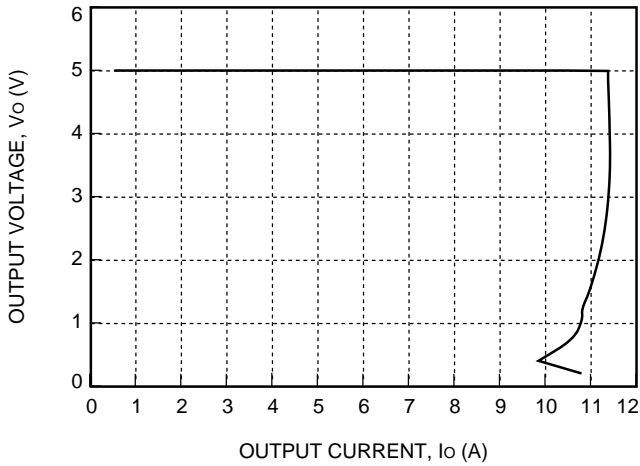

Figure 5. Typical JW050A Output Characteristics at Room Temperature

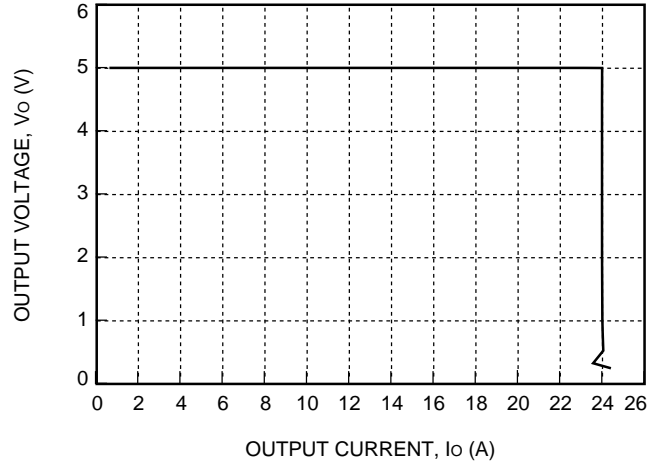

Figure 7. Typical JW100A Output Characteristics at Room Temperature

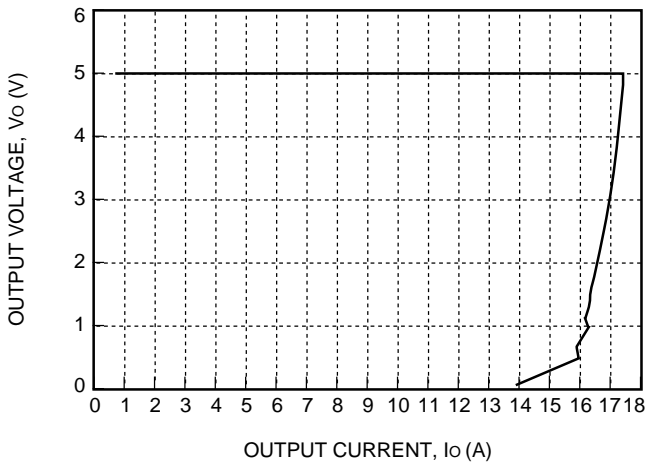

Figure 6. Typical JW075A Output Characteristics at Room Temperature

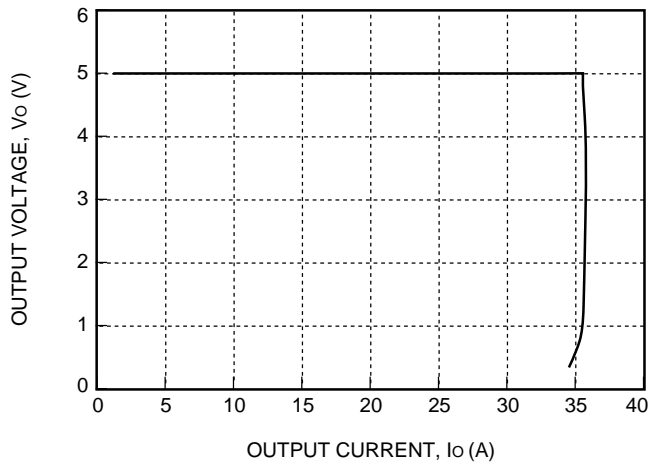
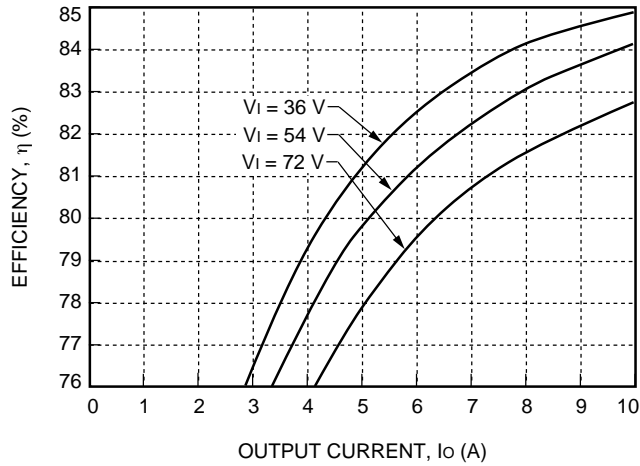

Figure 8. Typical JW150A Output Characteristics at Room Temperature

Characteristic Curves (continued)



8-1161 (C)

Figure 9. Typical JW050A Converter Efficiency vs. Output Current at Room Temperature

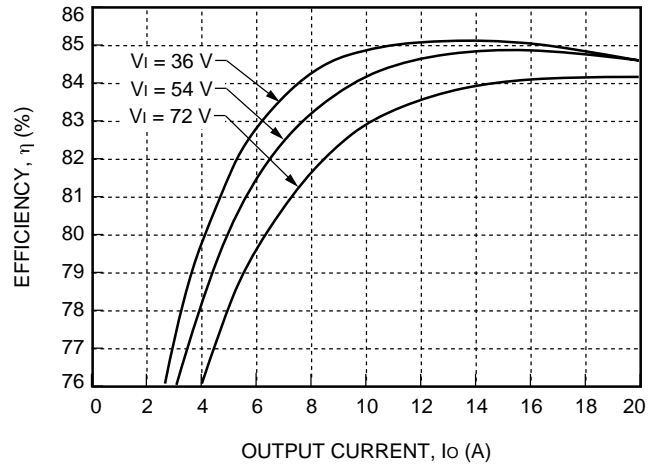

8-1163 (C)

Figure 11. Typical JW100A Converter Efficiency vs. Output Current at Room Temperature

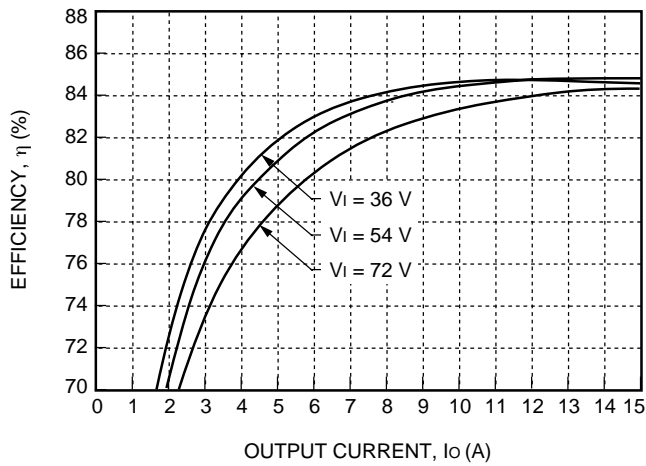

8-1132 (C)

Figure 10. Typical JW075A Converter Efficiency vs. Output Current at Room Temperature

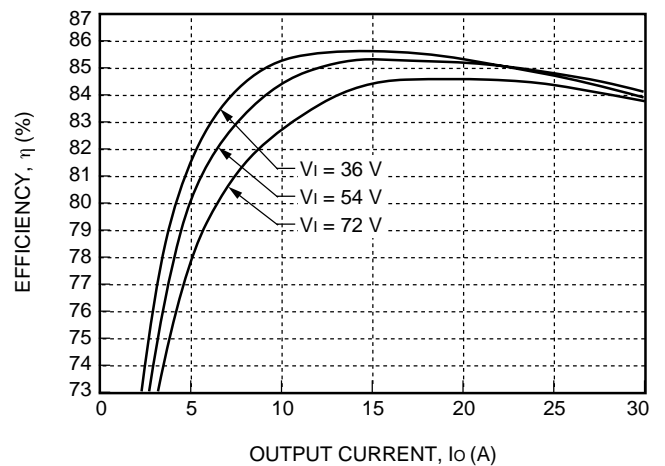

8-1138 (C)

Figure 12. Typical JW150A Converter Efficiency vs. Output Current at Room Temperature

Characteristic Curves (continued)

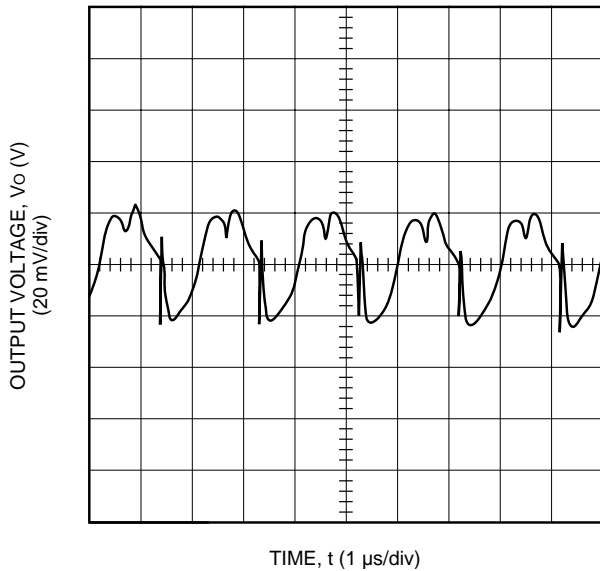

8-2014 (C)

Figure 13. Typical JW150A Output Ripple Voltage at Room Temperature, 48 V Input,  $I_o$  = Full Load

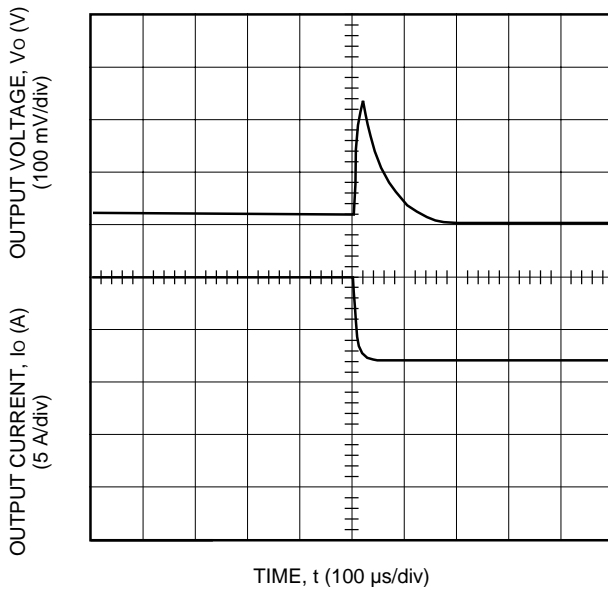

8-2057 (C)

Note: Tested with a 10  $\mu$ F aluminum and a 1.0  $\mu$ F ceramic capacitor across the load.

Figure 14. Typical JW150A Transient Response to Step Decrease in Load from 50% to 25% of Full Load at Room Temperature and 48 V Input (Waveform Averaged to Eliminate Ripple Component.)

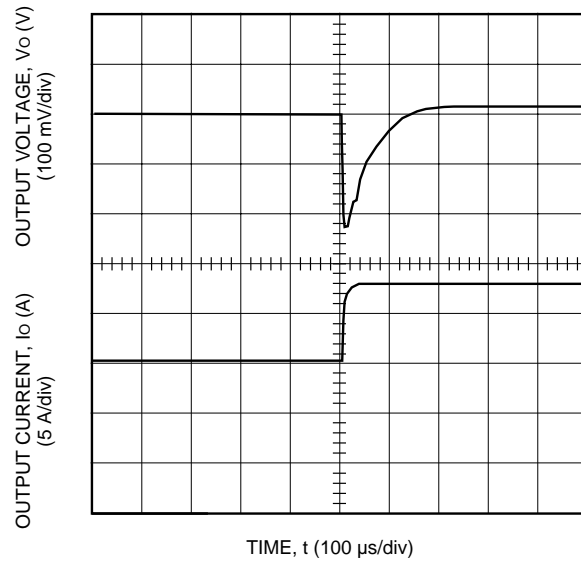

8-2058 (C)

Note: Tested with a 10  $\mu$ F aluminum and a 1.0  $\mu$ F ceramic capacitor across the load.

Figure 15. Typical JW150A Transient Response to Step Increase in Load from 50% to 75% of Full Load at Room Temperature and 48 V Input (Waveform Averaged to Eliminate Ripple Component.)

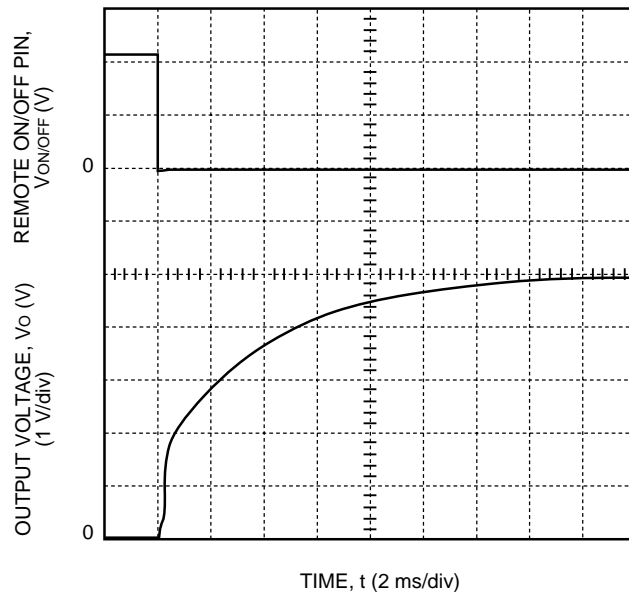

8-1143 (C),b

Note: Tested with a 10  $\mu$ F aluminum and a 1.0  $\mu$ F ceramic capacitor across the load.

Figure 16. Typical Start-Up from Remote On/Off JW150A1;  $I_o = I_{o,max}$



## Test Configurations

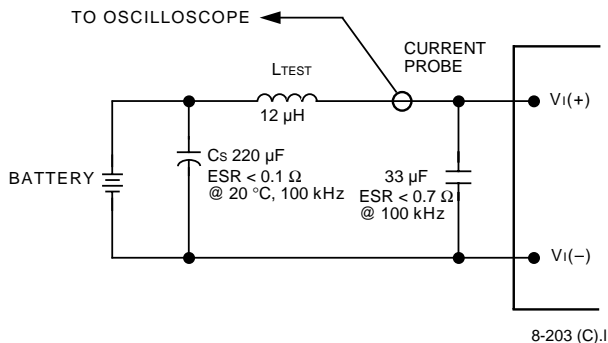

Note: Measure input reflected-ripple current with a simulated source inductance ( $L_{TEST}$ ) of 12  $\mu$ H. Capacitor  $C_s$  offsets possible battery impedance. Measure current as shown above.

Figure 17. Input Reflected-Ripple Test Setup

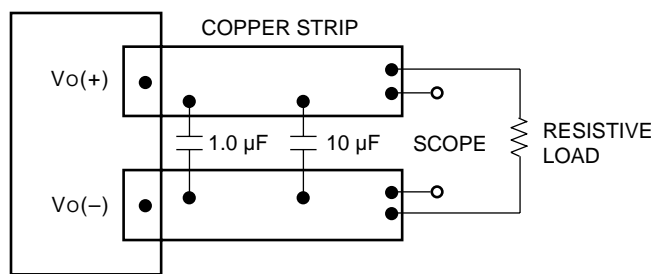

Note: Use a 1.0  $\mu$ F ceramic capacitor and a 10  $\mu$ F aluminum or tantalum capacitor. Scope measurement should be made using a BNC socket. Position the load between 51 mm and 76 mm (2 in. and 3 in.) from the module.

Figure 18. Peak-to-Peak Output Noise Measurement Test Setup

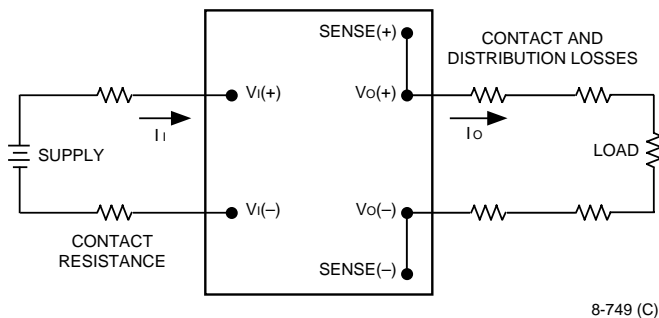

Note: All measurements are taken at the module terminals. When socketing, place Kelvin connections at module terminals to avoid measurement errors due to socket contact resistance.

$$\eta = \left( \frac{[V_o(+)] - [V_o(-)] I_o}{[V_i(+)] - [V_i(-)] I_i} \right) \times 100 \quad \%$$

Figure 19. Output Voltage and Efficiency Measurement Test Setup

## Design Considerations

### Input Source Impedance

The power module should be connected to a low ac-impedance input source. Highly inductive source impedances can affect the stability of the power module. For the test configuration in Figure 17, a 33  $\mu$ F electrolytic capacitor (ESR < 0.7  $\Omega$  at 100 kHz) mounted close to the power module helps ensure stability of the unit. For other highly inductive source impedances, consult the factory for further application guidelines.

## Safety Considerations

For safety-agency approval of the system in which the power module is used, the power module must be installed in compliance with the spacing and separation requirements of the end-use safety agency standard, i.e., *UL1950*, *CSA C22.2 No. 950-95*, and *VDE 0805 (EN60950, IEC950)*.

If the input source is non-SELV (ELV or a hazardous voltage greater than 60 Vdc and less than or equal to 75 Vdc), for the module's output to be considered meeting the requirements of safety extra-low voltage (SELV), all of the following must be true:

- The input source is to be provided with reinforced insulation from any hazardous voltages, including the ac mains.
- One  $V_I$  pin and one  $V_O$  pin are to be grounded or both the input and output pins are to be kept floating.
- The input pins of the module are not operator accessible.
- Another SELV reliability test is conducted on the whole system, as required by the safety agencies, on the combination of supply source and the subject module to verify that under a single fault, hazardous voltages do not appear at the module's output.

**Note:** Do not ground either of the input pins of the module without grounding one of the output pins. This may allow a non-SELV voltage to appear between the output pin and ground.

The power module has extra-low voltage (ELV) outputs when all inputs are ELV.

The input to these units is to be provided with a maximum 20 A normal-blow fuse in the ungrounded lead.

## Feature Descriptions

### Overcurrent Protection

To provide protection in a fault (output overload) condition, the unit is equipped with internal current-limiting circuitry and can endure current limiting for an unlimited duration. At the point of current-limit inception, the unit shifts from voltage control to current control. If the output voltage is pulled very low during a severe fault, the current-limit circuit can exhibit either foldback or tail-out characteristics (output current decrease or increase). The unit operates normally once the output current is brought back into its specified range.

## Remote On/Off

Two remote on/off options are available. Positive logic remote on/off turns the module on during a logic-high voltage on the ON/OFF pin, and off during a logic low. Negative logic remote on/off turns the module off during a logic high and on during a logic low. Negative logic (code suffix "1") is the factory-preferred configuration.

To turn the power module on and off, the user must supply a switch to control the voltage between the on/off terminal and the  $V_I(-)$  terminal ( $V_{on/off}$ ). The switch can be an open collector or equivalent (see Figure 20). A logic low is  $V_{on/off} = 0$  V to 1.2 V. The maximum  $I_{on/off}$  during a logic low is 1 mA. The switch should maintain a logic-low voltage while sinking 1 mA.

During a logic high, the maximum  $V_{on/off}$  generated by the power module is 15 V. The maximum allowable leakage current of the switch at  $V_{on/off} = 15$  V is 50  $\mu$ A.

If not using the remote on/off feature, do one of the following:

- For negative logic, short ON/OFF pin to  $V_I(-)$ .
- For positive logic, leave ON/OFF pin open.

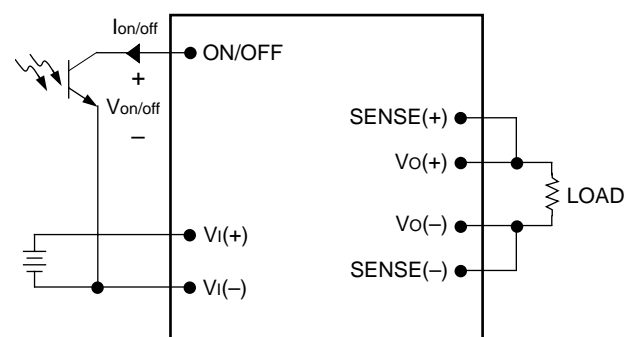

8-720 (C).c

Figure 20. Remote On/Off Implementation

## Feature Descriptions (continued)

### Remote Sense

Remote sense minimizes the effects of distribution losses by regulating the voltage at the remote-sense connections. The voltage between the remote-sense pins and the output terminals must not exceed the output voltage sense range given in the Feature Specifications table, i.e.:

$$[V_{O(+)} - V_{O(-)}] - [SENSE(+)-SENSE(-)] \leq 0.5 \text{ V}$$

The voltage between the  $V_{O(+)}$  and  $V_{O(-)}$  terminals must not exceed the minimum value of the output over-voltage protection. This limit includes any increase in voltage due to remote-sense compensation and output voltage set-point adjustment (trim). See Figure 21.

If not using the remote-sense feature to regulate the output at the point of load, then connect SENSE(+) to  $V_{O(+)}$  and SENSE(-) to  $V_{O(-)}$  at the module.

Although the output voltage can be increased by both the remote sense and by the trim, the maximum increase for the output voltage is not the sum of both. The maximum increase is the larger of either the remote sense or the trim. Consult the factory if you need to increase the output voltage more than the above limitation.

The amount of power delivered by the module is defined as the voltage at the output terminals multiplied by the output current. When using remote sense and trim, the output voltage of the module can be increased, which at the same output current would increase the power output of the module. Care should be taken to ensure that the maximum output power of the module remains at or below the maximum rated power.

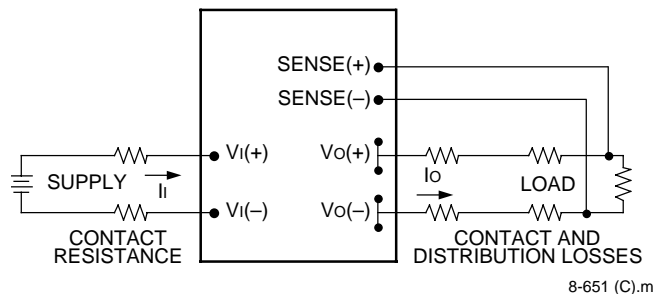

Figure 21. Effective Circuit Configuration for Single-Module Remote-Sense Operation

### Output Voltage Set-Point Adjustment (Trim)

Output voltage trim allows the user to increase or decrease the output voltage set point of a module. This is accomplished by connecting an external resistor between the TRIM pin and either the SENSE(+) or SENSE(-) pins. The trim resistor should be positioned close to the module.

If not using the trim feature, leave the TRIM pin open.

With an external resistor between the TRIM and SENSE(-) pins ( $R_{\text{adj-down}}$ ), the output voltage set point ( $V_{O, \text{adj}}$ ) decreases (see Figure 22). The following equation determines the required external-resistor value to obtain a percentage output voltage change of  $\Delta\%$ .

$$R_{\text{adj-down}} = \left( \frac{100}{\Delta\%} - 2 \right) \text{ k}\Omega$$

The test results for this configuration are displayed in Figure 23. This figure applies to all output voltages.

With an external resistor connected between the TRIM and SENSE(+) pins ( $R_{\text{adj-up}}$ ), the output voltage set point ( $V_{O, \text{adj}}$ ) increases (see Figure 24).

The following equation determines the required external-resistor value to obtain a percentage output voltage change of  $\Delta\%$ .

$$R_{\text{adj-up}} = \left( \frac{V_{O}(100 + \Delta\%)}{1.225\Delta\%} - \frac{(100 + 2\Delta\%) }{\Delta\%} \right) \text{ k}\Omega$$

The test results for this configuration are displayed in Figure 25.

The voltage between the  $V_{O(+)}$  and  $V_{O(-)}$  terminals must not exceed the minimum value of the output over-voltage protection. This limit includes any increase in voltage due to remote-sense compensation and output voltage set-point adjustment (trim). See Figure 21.

Although the output voltage can be increased by both the remote sense and by the trim, the maximum increase for the output voltage is not the sum of both. The maximum increase is the larger of either the remote sense or the trim. Consult the factory if you need to increase the output voltage more than the above limitation.

The amount of power delivered by the module is defined as the voltage at the output terminals multiplied by the output current. When using remote sense and trim, the output voltage of the module can be increased, which at the same output current would increase the power output of the module. Care should be taken to ensure that the maximum output power of the module remains at or below the maximum rated power.

**Feature Descriptions** (continued)

**Output Voltage Set-Point Adjustment (Trim)** (continued)

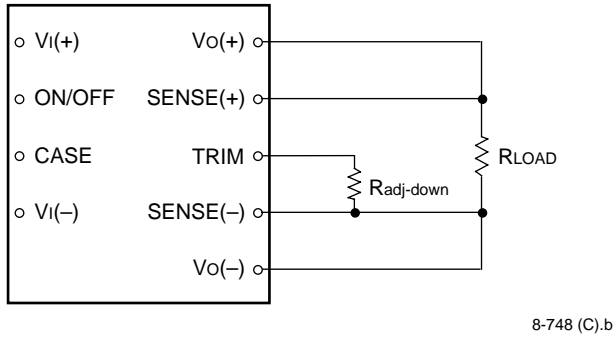

**Figure 22. Circuit Configuration to Decrease Output Voltage**

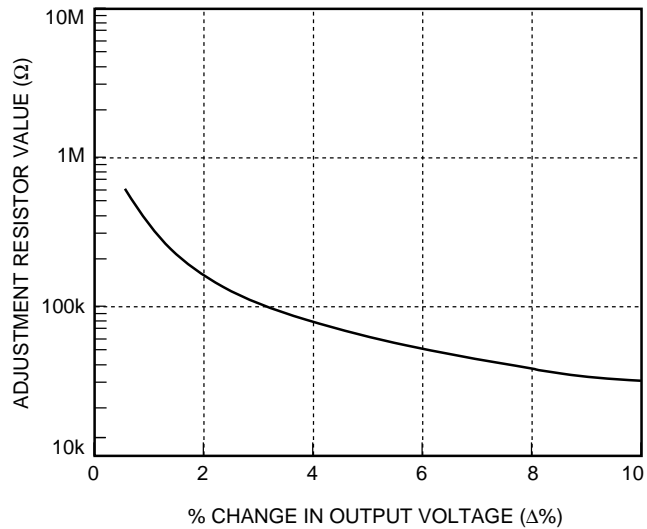

**Figure 25. Resistor Selection for Increased Output Voltage**

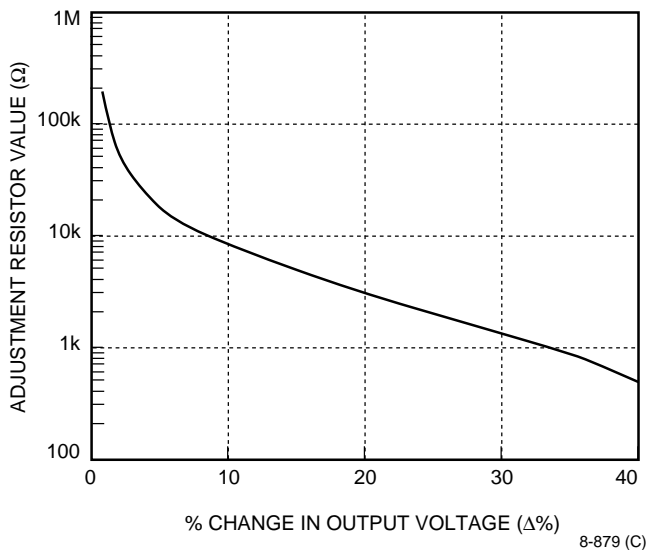

**Figure 23. Resistor Selection for Decreased Output Voltage**

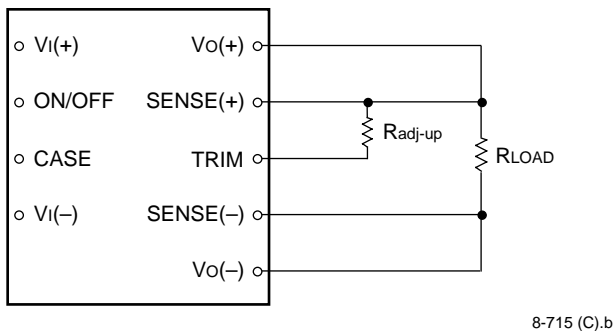

**Figure 24. Circuit Configuration to Increase Output Voltage**

**Output Overvoltage Protection**

The output overvoltage clamp consists of control circuitry, independent of the primary regulation loop, that monitors the voltage on the output terminals. The control loop of the clamp has a higher voltage set point than the primary loop (see Feature Specifications table). This provides a redundant voltage control that reduces the risk of output overvoltage.

**Overtemperature Protection**

The 100 W and 150 W modules feature an overtemperature protection circuit to safeguard against thermal damage.

The circuit shuts down the module when the maximum case temperature is exceeded. The module restarts automatically after cooling.

## Thermal Considerations

### Introduction

The power modules operate in a variety of thermal environments; however, sufficient cooling should be provided to help ensure reliable operation of the unit. Heat-dissipating components inside the unit are thermally coupled to the case. Heat is removed by conduction, convection, and radiation to the surrounding environment. Proper cooling can be verified by measuring the case temperature. Peak temperature ( $T_c$ ) occurs at the position indicated in Figure 26.

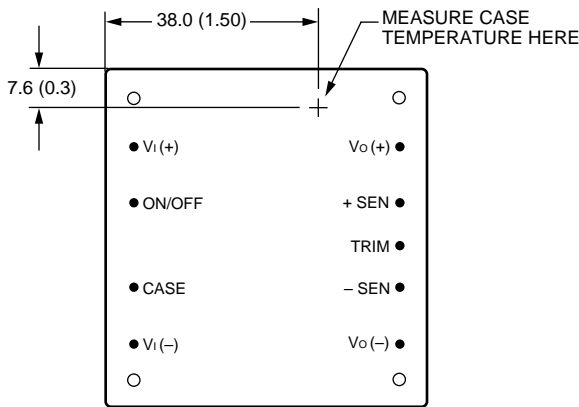

8-716 (C).f

Note: Top view, pin locations are for reference only.  
Measurements shown in millimeters and (inches).

**Figure 26. Case Temperature Measurement Location**

The temperature at this location should not exceed 100 °C. The output power of the module should not exceed the rated power for the module as listed in the Ordering Information table.

Although the maximum case temperature of the power modules is 100 °C, you can limit this temperature to a lower value for extremely high reliability.

For additional information on these modules, refer to the *Thermal Management JC-, JFC-, JW-, and JFW-Series 50 W to 150 W Board-Mounted Power Modules* Technical Note (TN97-008EPS).

### Heat Transfer Without Heat Sinks

Increasing airflow over the module enhances the heat transfer via convection. Figure 27 shows the maximum power that can be dissipated by the module without exceeding the maximum case temperature versus local ambient temperature ( $T_A$ ) for natural convection through 4 m/s (800 ft./min.).

Note that the natural convection condition was measured at 0.05 m/s to 0.1 m/s (10 ft./min. to 20 ft./min.); however, systems in which these power modules may be used typically generate natural convection airflow rates of 0.3 m/s (60 ft./min.) due to other heat dissipating components in the system. The use of Figure 27 is shown in the following example.

#### Example

What is the minimum airflow necessary for a JW100A operating at  $V_i = 54$  V, an output current of 20 A, and a maximum ambient temperature of 40 °C?

#### Solution

Given:  $V_i = 54$  V  
 $I_o = 20$  A  
 $T_A = 40$  °C

Determine  $P_D$  (Use Figure 30.):

$$P_D = 17 \text{ W}$$

Determine airflow ( $v$ ) (Use Figure 27.):

$$v = 2.0 \text{ m/s (400 ft./min.)}$$

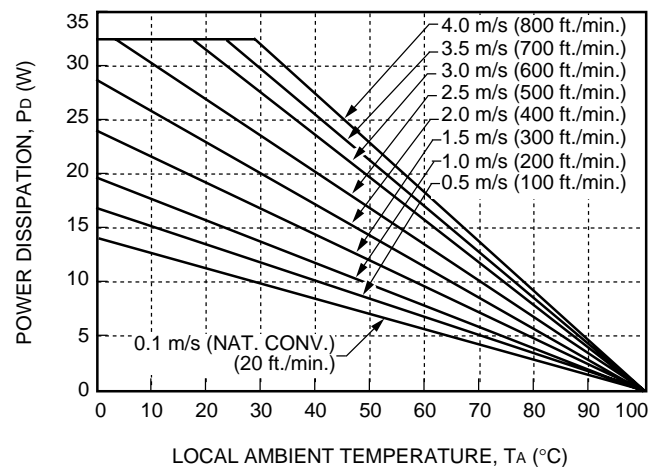

8-1150 (C).a

**Figure 27. Forced Convection Power Derating with No Heat Sink; Either Orientation**

**Thermal Considerations** (continued)

**Heat Transfer Without Heat Sinks** (continued)

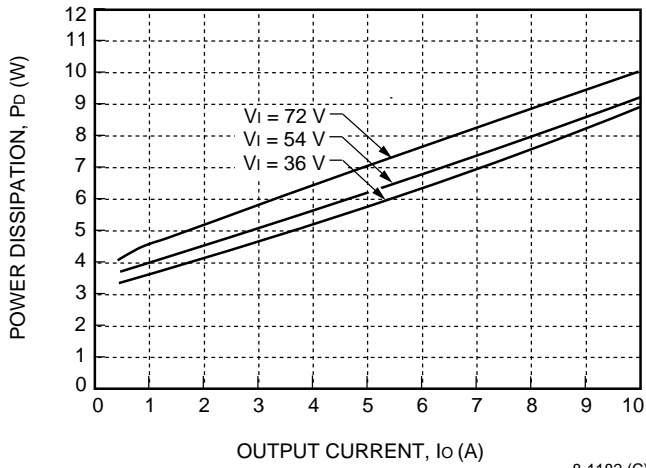

**Figure 28. JW050A Power Dissipation vs. Output Current**

8-1182 (C)

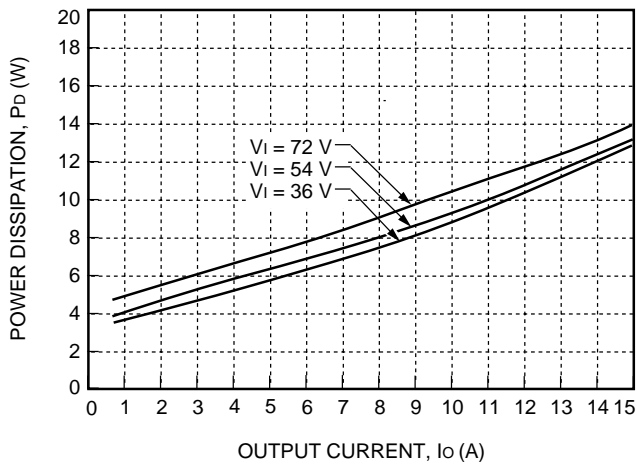

**Figure 29. JW075A Power Dissipation vs. Output Current**

8-1183 (C)

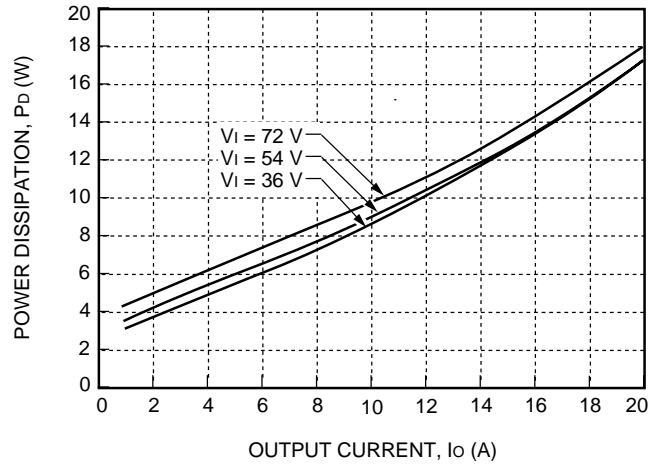

**Figure 30. JW100A Power Dissipation vs. Output Current**

8-1184 (C)

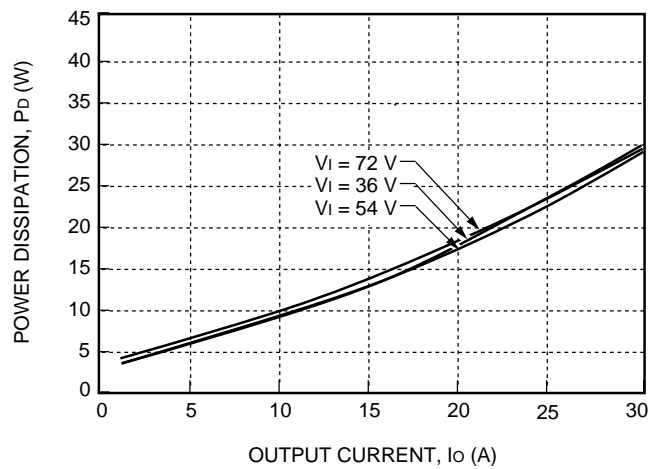

**Figure 31. JW150A Power Dissipation vs. Output Current**

8-1185 (C)

## Thermal Considerations (continued)

### Heat Transfer with Heat Sinks

The power modules have through-threaded, M3 x 0.5 mounting holes, which enable heat sinks or cold plates to attach to the module. The mounting torque must not exceed 0.56 N-m (5 in.-lb.). For a screw attachment from the pin side, the recommended hole size on the customer's PWB around the mounting holes is  $0.130 \pm 0.005$  inches. If a larger hole is used, the mounting torque from the pin side must not exceed 0.25 N-m (2.2 in.-lb.).

Thermal derating with heat sinks is expressed by using the overall thermal resistance of the module. Total module thermal resistance ( $\theta_{ca}$ ) is defined as the maximum case temperature rise ( $\Delta T_{C, \max}$ ) divided by the module power dissipation ( $P_D$ ):

$$\theta_{ca} = \left[ \frac{\Delta T_{C, \max}}{P_D} \right] = \left[ \frac{(T_C - T_A)}{P_D} \right]$$

The location to measure case temperature ( $T_C$ ) is shown in Figure 26. Case-to-ambient thermal resistance vs. airflow is shown, for various heat sink configurations and heights, in Figure 32. These curves were obtained by experimental testing of heat sinks, which are offered in the product catalog.

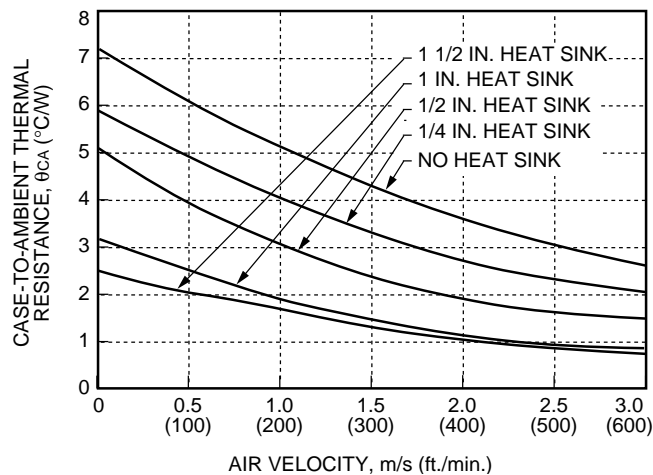

8-1153 (C)

**Figure 32. Case-to-Ambient Thermal Resistance Curves; Either Orientation**

These measured resistances are from heat transfer from the sides and bottom of the module as well as the top side with the attached heat sink; therefore, the case-to-ambient thermal resistances shown are generally lower than the resistance of the heat sink by itself. The module used to collect the data in Figure 32 had a thermal-conductive dry pad between the case and the heat sink to minimize contact resistance. The use of Figure 32 is shown in the following example.

### Example

If an 85 °C case temperature is desired, what is the minimum airflow necessary? Assume the JW100A module is operating at  $V_I = 54$  V and an output current of 20 A, maximum ambient air temperature of 40 °C, and the heat sink is 1/2 inch.

### Solution

Given:  $V_I = 54$  V  
 $I_O = 20$  A  
 $T_A = 40$  °C  
 $T_C = 85$  °C  
 Heat sink = 1/2 in.

Determine  $P_D$  by using Figure 30:

$$P_D = 17 \text{ W}$$

Then solve the following equation:

$$\theta_{ca} = \left[ \frac{(T_C - T_A)}{P_D} \right]$$

$$\theta_{ca} = \left[ \frac{(85 - 40)}{17} \right]$$

$$\theta_{ca} = 2.6 \text{ °C/W}$$

Use Figure 32 to determine air velocity for the 1/2 inch heat sink.

The minimum airflow necessary for the JW100A module is 1.3 m/s (260 ft./min.).

## Thermal Considerations (continued)

### Custom Heat Sinks

A more detailed model can be used to determine the required thermal resistance of a heat sink to provide necessary cooling. The total module resistance can be separated into a resistance from case-to-sink ( $\theta_{cs}$ ) and sink-to-ambient ( $\theta_{sa}$ ) shown below (Figure 33).

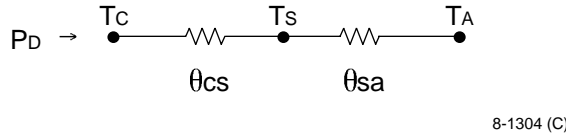

**Figure 33. Resistance from Case-to-Sink and Sink-to-Ambient**

For a managed interface using thermal grease or foils, a value of  $\theta_{cs} = 0.1 \text{ }^\circ\text{C/W}$  to  $0.3 \text{ }^\circ\text{C/W}$  is typical. The solution for heat sink resistance is:

$$\theta_{sa} = \left[ \frac{(T_C - T_A)}{P_D} \right] - \theta_{cs}$$

This equation assumes that all dissipated power must be shed by the heat sink. Depending on the user-defined application environment, a more accurate model, including heat transfer from the sides and bottom of the module, can be used. This equation provides a conservative estimate for such instances.

## Solder, Cleaning, and Drying Considerations

Post solder cleaning is usually the final circuit-board assembly process prior to electrical testing. The result of inadequate circuit-board cleaning and drying can affect both the reliability of a power module and the testability of the finished circuit-board assembly. For guidance on appropriate soldering, cleaning, and drying procedures, refer to the *Board-Mounted Power Modules Soldering and Cleaning* Application Note (AP97-021EPS).

## EMC Considerations

For assistance with designing for EMC compliance, please refer to the FLTR100V10 data sheet (DS98-152EPS).

## Layout Considerations

Copper paths must not be routed beneath the power module mounting inserts. For additional layout guidelines, refer to the FLTR100V10 data sheet (DS98-152EPS).



## Outline Diagram

Dimensions are in millimeters and (inches).

Tolerances: x.x mm  $\pm$  0.5 mm (x.xx in.  $\pm$  0.02 in.)  
x.xx mm  $\pm$  0.25 mm (x.xxx in.  $\pm$  0.010 in.)

### Top View

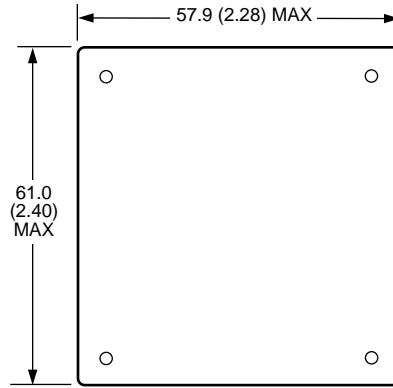

### Side View

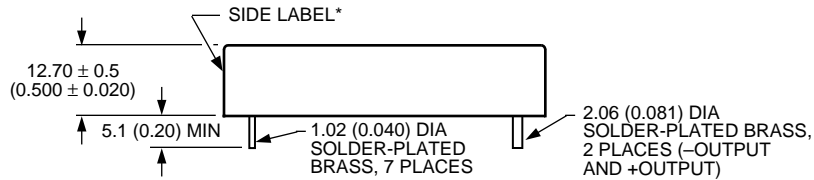

### Bottom View

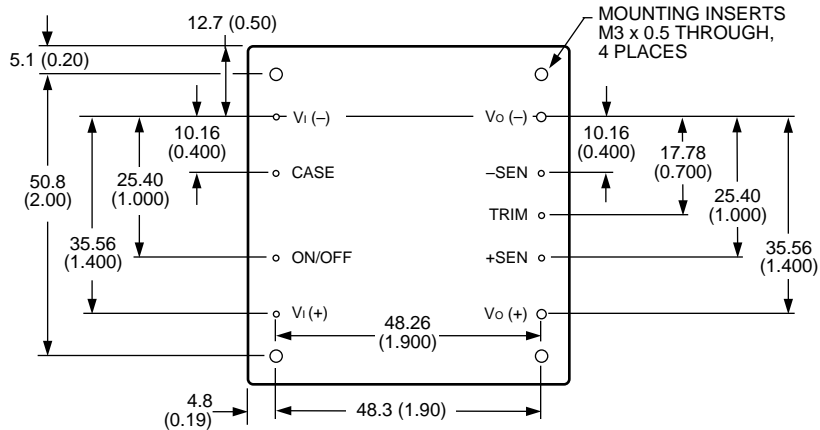

8-1945 (C).a

\* Side label includes Tyco name, product designation, safety agency markings, input/output voltage and current ratings, and bar code.

## Recommended Hole Pattern

Component-side footprint.

Dimensions are in millimeters and (inches).

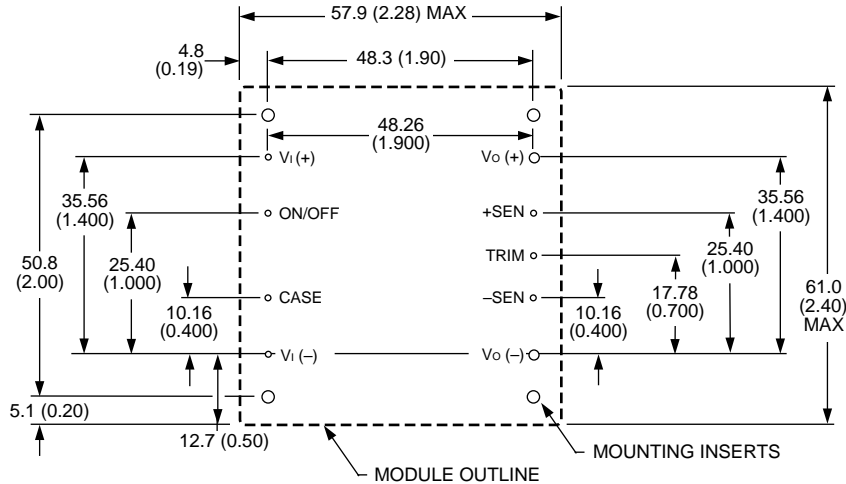

8-1945 (C).a

## Ordering Information

**Table 4. Device Codes**

Input Voltage	Output Voltage	Output Power	Remote On/Off Logic	Device Code	Comcode
48 V	5.0 V	50 W	Negative	JW050A1	107361370
48 V	5.0 V	75 W	Negative	JW075A1	107071581
48 V	5.0 V	100 W	Negative	JW100A1	107361404
48 V	5.0 V	150 W	Negative	JW150A1	107361453
48 V	5.0 V	50 W	Positive	JW050A	107304792
48 V	5.0 V	75 W	Positive	JW075A	107361388
48 V	5.0 V	100 W	Positive	JW100A	107002750
48 V	5.0 V	150 W	Positive	JW150A	107361446

**Ordering Information** (continued)

**Table 5. Device Accessories**

Accessory	Comcode
1/4 in. transverse kit (heat sink, thermal pad, and screws)	407243989
1/4 in. longitudinal kit (heat sink, thermal pad, and screws)	407243997
1/2 in. transverse kit (heat sink, thermal pad, and screws)	407244706
1/2 in. longitudinal kit (heat sink, thermal pad, and screws)	407244714
1 in. transverse kit (heat sink, thermal pad, and screws)	407244722
1 in. longitudinal kit (heat sink, thermal pad, and screws)	407244730
1 1/2 in. transverse kit (heat sink, thermal pad, and screws)	407244748
1 1/2 in. longitudinal kit (heat sink, thermal pad, and screws)	407244755

Dimensions are in millimeters and (inches).

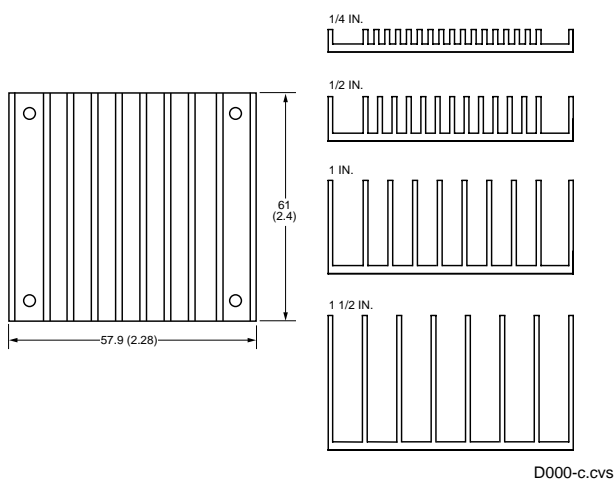

**Figure 34. Longitudinal Heat Sink**

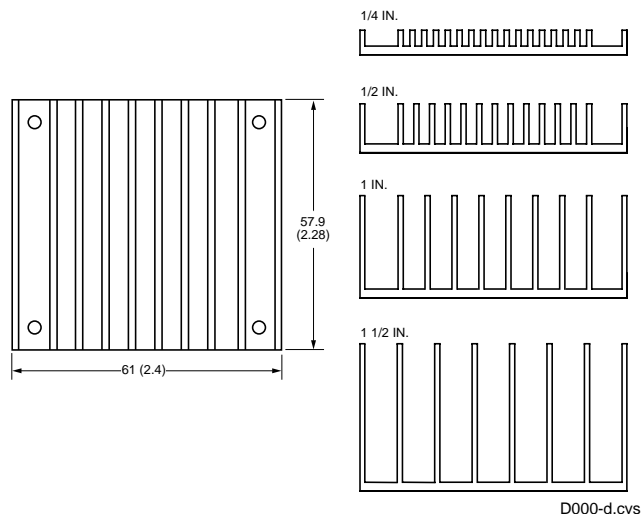

**Figure 35. Transverse Heat Sink**



**Tyco Electronics Power Systems, Inc.**  
3000 Skyline Drive, Mesquite, TX 75149, USA  
**+1-800-526-7819** FAX: +1-888-315-5182  
(Outside U.S.A.: **+1-972-284-2626**, FAX: +1-972-284-2900  
<http://power.tycoelectronics.com>

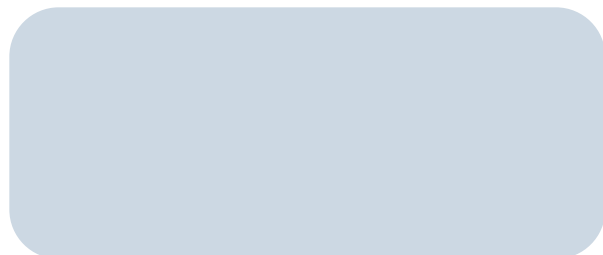

---

Tyco Electronics Corporation reserves the right to make changes to the product(s) or information contained herein without notice. No liability is assumed as a result of their use or application. No rights under any patent accompany the sale of any such product(s) or information.

© 2001 Tyco Electronics Corporation, Harrisburg, PA. All International Rights Reserved.  
Printed in U.S.A.

July 1999  
DS99-284EPS (Replaces DS98-088EPS)