

Adaptive 100/120Hz Current Ripple Remover Max Input Current $\leq 1A$

Parameters Subject to Change Without Notice

FEATURES

- Adaptive 100/120Hz current ripple remover
- Input voltage range 5V~60V
- Built-in 60V power MOSFET
- LED voltage low to 0.4V when LED current is 0.7A
- Programmable LED current ripple
- Programmable maximum LED cathode voltage
- Internal LED voltage limit
- Internal LED current limit
- Short/Open protection
- Hot plug protection
- Over temperature protection
- TO252-5L package

DESCRIPTION

JW1232 is used to drive a LED string ($\leq 50V$), and remove the 100/120Hz current ripple on AC/DC power by a capacitor between VC and GND.

If the voltage on LED pin exceeds 6V, the current ripple removing function is disabled, which could help limit the power dissipation on chip. JW1232 provides short protection, open protection and HOT-PLUG protection.

The maximum LED current is internally limited at 1.6A.

JW1232 provides over thermal protection. When the OTP is triggered, the internal MOSFET shuts down until the temperature decreases to 120°C.

APPLICATIONS

- LED lightning

Company's Logo is Protected, "JW" and "JOULWATT" are Registered Trademarks of JoulWatt technology Inc.

TYPICAL APPLICATION

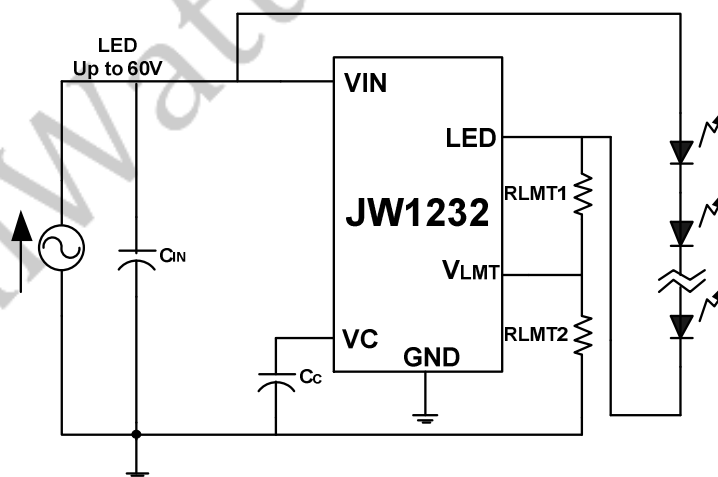

ORDERING INFORMATION

LEAD FREE FINISH	TAPE AND REEL	PACKAGE	TOP MARKING	JUNCTION TEMPERATURE RANGE
JW1232TOB#PBF	JW1232TOB#TRPBF	TO252-5	JW1232	- 40 °C to 150 °C

JWXXXXPPPP#TRPBF

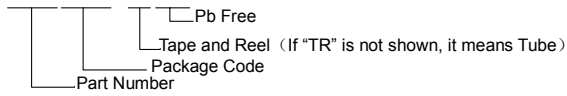

PIN CONFIGURATION

Top View

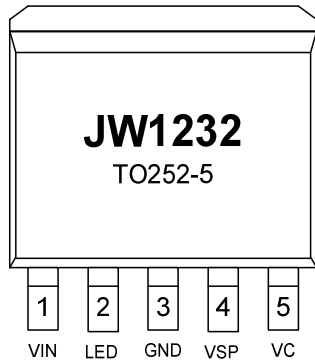

TO252-5

ABSOLUTE MAXIMUM RATING ¹⁾

VIN PIN	60V
LED PIN	-0.3 to 60V
VC, VLMT	-0.3V to 6V
Junction Temperature ^{2) 3)}	150°C
Lead Temperature	260 °C
Storage Temperature	-65 °C to +150 °C

RECOMMENDED OPERATING RANGE

VIN	4.7V to 55V
LED pin	<60V
Maximum Junction Temperature (T _J)	150°C

THERMAL RESISTANCE⁴⁾ θ_{JA} θ_{JC}

TO252-5L	45°C /W
----------	---------

Note:

- 1) Exceeding these ratings may damage the device.
- 2) The JW1232 guarantees robust performance from -40°C to 150°C junction temperature. The junction temperature range specification is assured by design, characterization and correlation with statistical process controls.
- 3) The JW1232 includes thermal protection that is intended to protect the device in overload conditions. Thermal protection is active when junction temperature exceeds the maximum operating junction temperature. Continuous operation over the specified absolute maximum operating junction temperature may damage the device.
- 4) Measured on JESD51-7, 2-layer PCB.

ELECTRICAL CHARACTERISTICS

V_{IN} = 12V, T_A = 25°C, unless otherwise stated.

Item	Symbol	Condition	Min.	Typ.	Max.	Units
V _{IN} Start Up Voltage Threshold	V _{IN_ON}		9	10	11	V
V _{IN} Start Up Voltage Hysteresis	V _{IN_HYS}			4		V
V _{IN} Operation Current	I _{IN}	I _{LED} =700mA	0.12	0.20	0.34	mA
LED Voltage Limit Threshold	V _{TH_VLMT}	LED voltage when voltage limit is triggered	5.4	6	6.6	V
LED Short Protection Threshold	V _{TH_SHORT}	VSP voltage when short protection is triggered.	1.8	2	2.2	V
LED Open Protection Threshold	I _{TH_OPEN}	LED current when open protection is triggered.		50		mA
LED Short/Open Protection Delay	TP		30	45	60	us
LED Short Protection hold time	TSH		5	7.5	10	ms
LED Open Protection hold time	TOH		0.2	0.3	0.4	ms
Regulated LED Pin Voltage	V _{LEDR}	I _{LED} =700mA	0.25	0.40	0.65	V
LED Current Limit	I _{CLMT}		1.0		1.6	A
Over Temperature Protection Threshold	OTP			140		°C
OTP Recovery Threshold				120		°C

PIN DESCRIPTION

TO252-5L

Pin No.	Name	Description
1	VIN	Power Supply
2	LED	Connect to Cathode of LED string
3	GND	Power Ground
4	VLMT	LED Short Protection Threshold Programming
5	VC	LED Current Ripple Programming

TYPICAL PERFORMANCE CHARACTERISTICS

Note: The pre-driver is JW1600 32W T8 program whose output specification is 42V/700mA and the output capacitances choose electrolytic capacitor 960uF. The V_O noted in the figure below refers to the pre-driver output voltage, I_{LED} refers to the output current, and V_{LED} refers to the JW1232 LED pin voltage.

LED current w/o JW1232

(VIN=220V, I_o=700mA, V_o=42V, electrolytic capacitor 960uF/63V)

current ripple:276mA, 40%

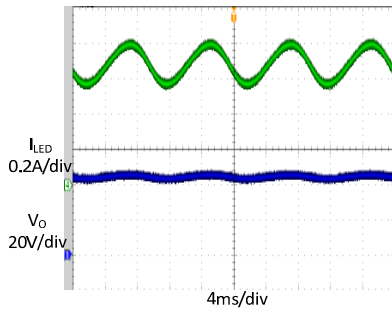

LED Open test

LED current with JW1232

(VIN=220V, I_o=700mA, V_o=42V, electrolytic capacitor 960uF/63V)

current ripple:20mA, 2.6%

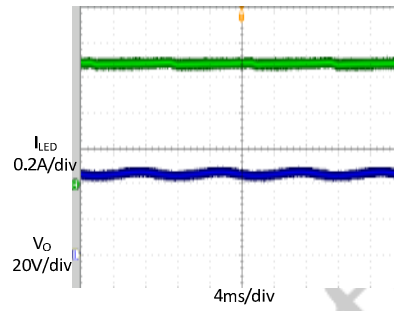

LED Short test

System Efficiency comparison with or without JW1232

(VIN=220V, I_o=700mA, V_o=42V, electrolytic capacitor 960uF/63V)

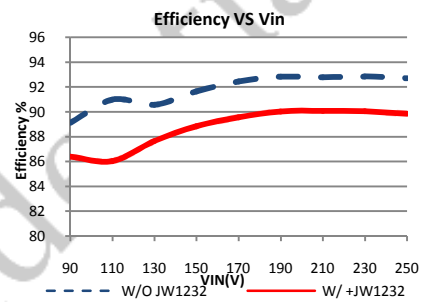

Pre-driver output capacitor short test

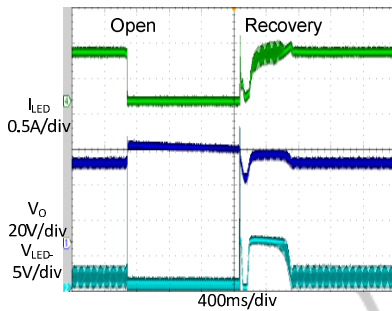

LED hot plug test

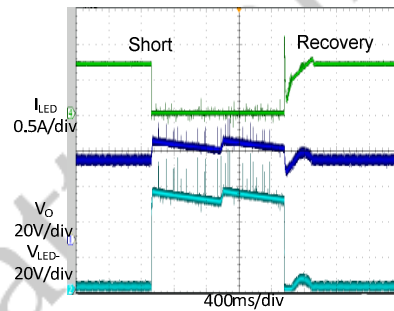

Continuous power on/off test

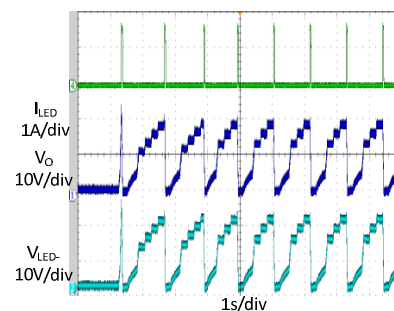
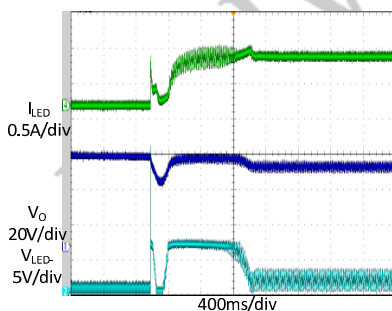
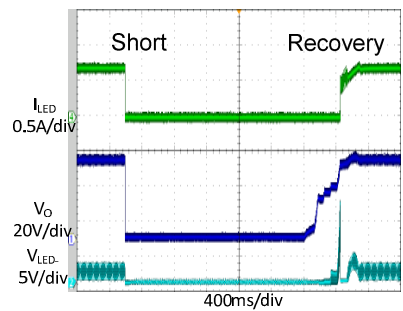

FUNCTIONAL DESCRIPTION

JW1232 is designed for driving one LED string ($\leq 50V$) and removing the 100/120Hz LED current ripple.

Theory of Operation

The LED string and JW1232 are both supplied by an AC/DC current source. The LED pin is connected to the cathode of LED string. JW1232 transfers the LED current ripple to voltage ripple on chip, and ensures the constant voltage across LED string and the current flow through LED string.

The scalable adaptive function of JW1232 can regulate the cathode voltage of LED string to minimum to improve the efficiency of the system.

Current Ripple Removing

The capacitor C_C between VC and GND is a integration capacitor. JW1232 transform the voltage on C_C to a reference voltage. The current regulator regulates LED current via negative feedback control.

The relationship between the voltage on C_C and LED current is shown as following:

$$I_{LED} = V_{VC} * 800 \text{ (mA)}$$

C_C should be large enough in order to remove the current ripple of the LED string. However, too large capacitor may slow down the dynamic response.

Adaptive Regulation

JW1232 control the voltage on C_C by monitoring the operation state of built-in NMOSFET. The efficiency of system is relatively low when NMOSFET always work in the saturation region. JW1232 detects it and charges C_C to raise the V_{VC} and I_{LED} , then the output voltage of power supply is reduced, and the voltage drop on NMOSFET decreases.

Conversely, when NMOSFET is working in the linear region, LED current regulation loop is open. JW1232 detects it and discharges C_C to reduce the V_{VC} and I_{LED} , then the output voltage of power supply is raised, and the LED current regulation loop is close.

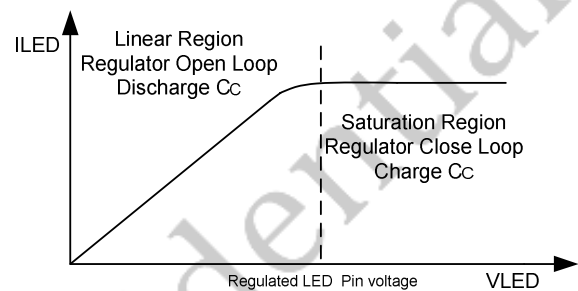

LED Pin Voltage Limit

The voltage ripple on LED pin is very large when the current ripple is removed, which would bring large power dissipation on chip. JW1232 limit the voltage on LED pin as 6V internally. When the voltage on LED pin reaches 6V, the current ripple removing function is blocked.

LED Current Limit

The current of LED is limited to 1.6A internally. The current limitation can protect the chip when LED is short connected or HOT-PLUG.

The function of current limit is higher priority than LED Pin voltage limit. It means that the voltage on LED Pin is limited when LED current exceed 1.6A.

LED Short Protection

The resistor divider connected between LED and GND can setup the Short protection threshold. When the voltage input to VSP Pin is exceed 2V

and the state holds for more than 60us, JW1232 considers the LED string is SHORT connected, and shut down the internal MOSFET.

The shut down state is latched for 10ms hold time. After 10ms, the SHORT state is reset, and the MOSFET restart.

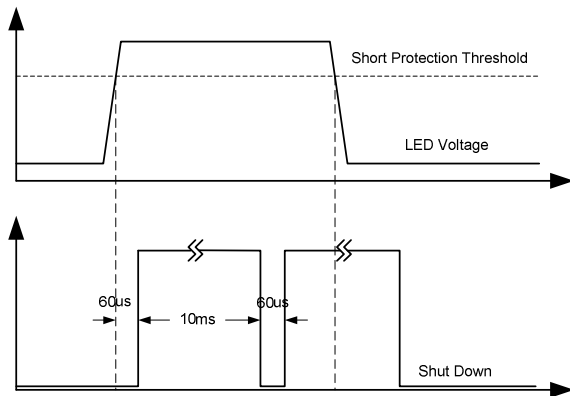

The short protection threshold is calculated as below:

$$V_{TH_SP} = 2V * (R_1 + R_2) / R_2$$

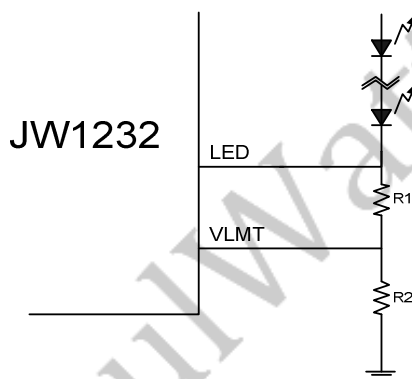

Open and HOT-PLUG Protection

When JW1232 detects that LED current is lower than 50mA, and the state holds for more than 60us, JW1232 considers the LED string is OPEN connected, and shuts down the internal MOSFET. The shut down state is latched for 0.5ms hold time. The MOSFET restart after 0.5ms.

If the LED string is connected suddenly during MOSFET restart, the OPEN state is reset, internal MOSFET is turned on and the LED current is limited at 1.6A.

Over Thermal Protection

JW1232 monitors operation temperature. When the temperature is higher than 140°C, the internal MOSFET is shut down until the temperature drop to 120°C.

PCB Design Guideline

1. The bypass capacitor of VIN should be placed as close as possible to the VIN pin and GND pin of IC.
2. JW1232 should be placed far away from the power devices such as MOSFET and SBD.
3. The area of LED current loop should be as small as possible.

APPLICATION NOTE

JW1232 design guide:

1. Design considerations:
 - a) The maximum voltage rating of LED pin is 60V, so the overvoltage threshold of the pre-driver must be lower than 60V in order to protect the chip in LED short condition.
 - b) A LED string should be used to test the characteristics of JW1232 including open and short circuit test.
2. The recommended operating current of JW1232 is 0.8A (max 1A). The power loss and temperature rise of the chip depend on the amplitude of the output current ripple and the final amplitude required.
3. Based on the power factor correction of the pre-driver, the law of energy conservation and reasonable temperature rise of the JW1232, the output capacitance of the pre-driver can be approximately calculated as follows:

P_{IN}: Input power

P_{OUT}: Output power

P_D: Power loss of JW1232

I_{LED}: LED current

U: Output voltage

V_{MIN}: the minimum LED pin voltage

△U: Peak to peak output voltage ripple

V_{LED-}: LED- pin voltage

T: line cycle

η: Efficiency of the system

 - a) The power factor correction of the pre-driver and the law of conservation of energy:

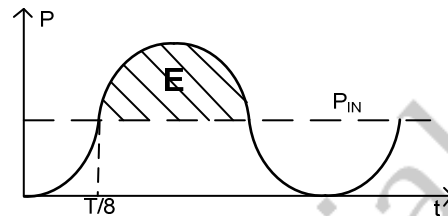

$$P_{IN} = (P_{OUT} + P_D) / \eta \tag{1}$$

$$E = 2 \left[P_{IN} * \frac{T}{8} - \int_0^{T/8} P_{IN} (1 - \cos 2\omega t) dt \right] \tag{2}$$

b) The energy formula of capacitance:

$$E = \frac{1}{2} * C \left[\left(U + \frac{\Delta U}{2} \right)^2 - \left(U - \frac{\Delta U}{2} \right)^2 \right] \tag{3}$$

c) The reasonable temperature rise of the JW1232

$$V_{MIN} = I_{LED} * R_{DS(ON)} \tag{4}$$

$$P_D \approx I_{LED} * V_{LED-} \approx I_{LED} * \left(\frac{\Delta U}{2} + V_{MIN} \right) \tag{5}$$

$$C = \frac{P_{OUT} + P_D}{2 * \pi * f * \eta * P_{OUT} * \Delta U} * I_{LED} \tag{6}$$

d) The smaller output power, the larger capacitance is needed as it can be seen in the equation above.

e) For example :

- i. Given : P_D=1W (Equivalent to 40°C temperature rise); η=0.85; f=1/T=50Hz

Then,

The result shows in the following figure:

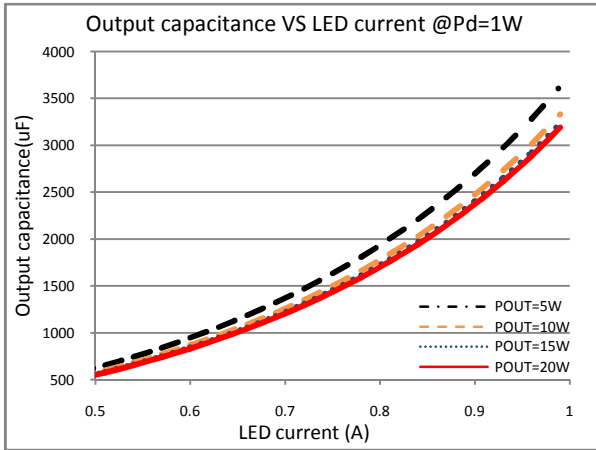

- ii. Given : $P_D=2W$ (Equivalent to $80^\circ C$ temperature rise); $\eta=0.85$;
 $f=1/T=50Hz$

Then the result shows in the below:

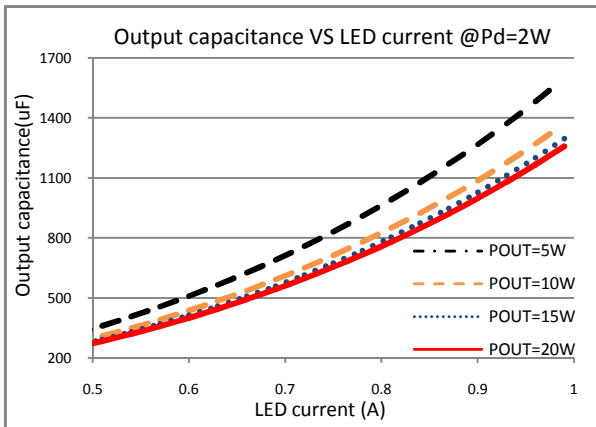

- 4. JW1232 allows user to setup the SCP voltage via a resistor divider. When the V_{VLMT} is higher than 2V, JW1232 shuts down the MOSFET internal and recovers when V_{VLMT} is lower than 2V. Also, the SCP voltage must meet the following conditions:

$$V_{OVP} - V_F < V_{SCP} < V_F$$

$$V_{SCP} < V_{INSTART} = I_Q * R_{VIN} + V_{INRISING}$$

R_{VIN} : the resistor between anode of the input and the VIN pin.

$V_{INRISING}$: VIN Start Up Voltage Threshold.

- 5. The capacitance between VC and GND determines the final current ripple. It should be large enough to remove the LED current ripple. However, too large capacitor may slow down the dynamic response. 1uF or 2.2uF is recommended.

APPLICATION REFERENCE

Reference 1:

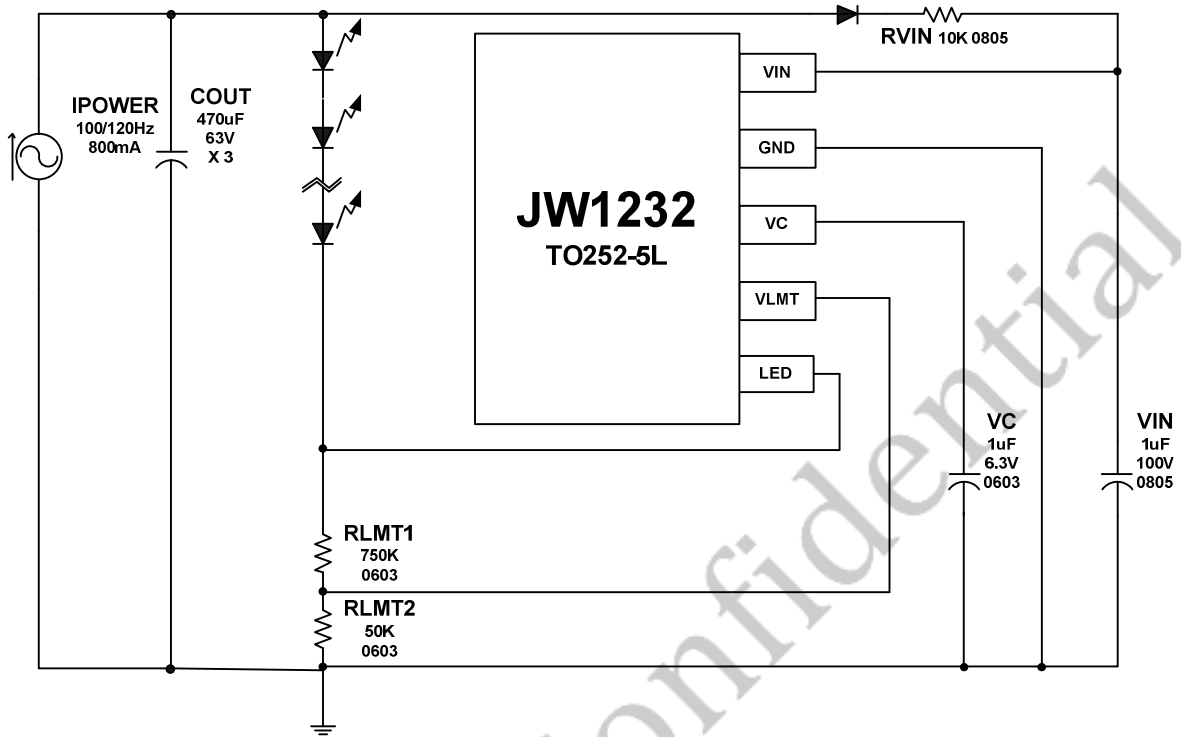

PACKAGE OUTLINE

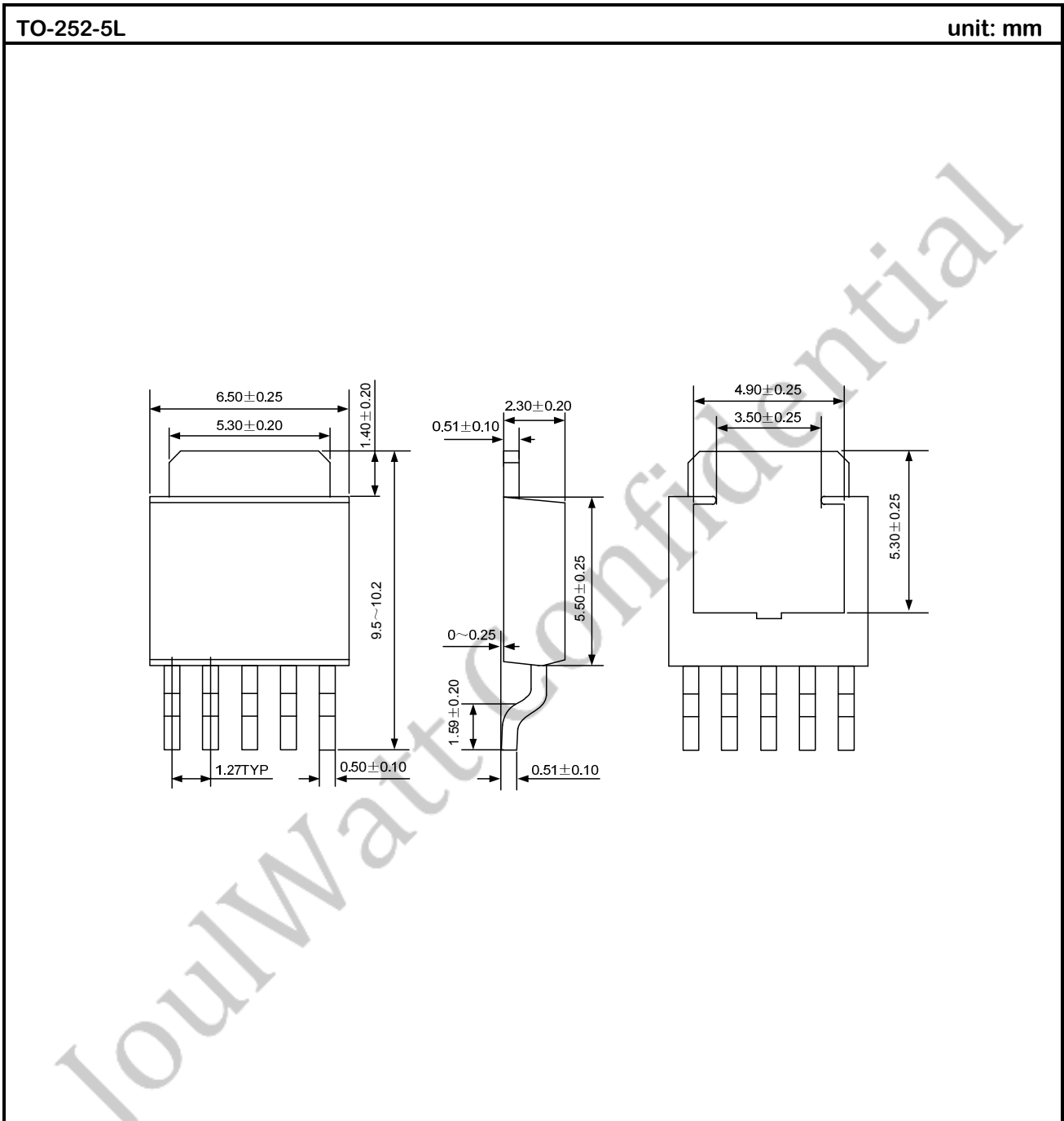

IMPORTANT NOTICE

- Joulwatt Technology Inc. reserves the right to make modifications, enhancements, improvements, corrections or other changes without further notice to this document and any product described herein.
- Any unauthorized redistribution or copy of this document for any purpose is strictly forbidden.
- Joulwatt Technology Inc. does not warrant or accept any liability whatsoever in respect of any products purchased through unauthorized sales channel.
- When using this product, Joulwatt Technology Inc. has no responsibility for any direct or indirect loss caused by the use of the product or attached material.

JoulWatt Confidential

Copyright © 2014 JW1232 Incorporated.

All rights are reserved by Joulwatt Technology Inc.