

HighSpeed 2-Technology with soft, fast recovery anti-parallel Emitter Controlled HE diode

- **Designed for:**
 - TV – Horizontal Line Deflection
- **2nd generation HighSpeed-Technology for 1200V applications offers:**
 - loss reduction in resonant circuits
 - temperature stable behavior
 - parallel switching capability
 - tight parameter distribution
 - Integrated anti-parallel diode
 - E_{off} optimized for $I_C = 3A$

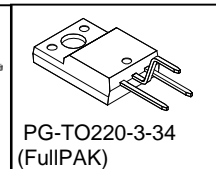
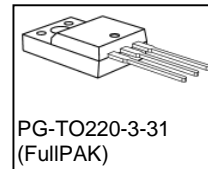
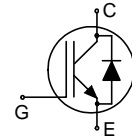

- Qualified according to JEDEC² for target applications
- Pb-free lead plating; RoHS compliant
- Complete product spectrum and PSpice Models : <http://www.infineon.com/igbt/>

| Type | V_{CE} | I_C | E_{off} | T_j | Marking | Package |
|-------------|----------|-------|-----------|-------|----------|----------------|
| IKA03N120H2 | 1200V | 3A | 0.15mJ | 150°C | K03H1202 | PG-TO-220-3-31 |
| IKA03N120H2 | 1200V | 3A | 0.15mJ | 150°C | K03H1202 | PG-TO-220-3-34 |

Maximum Ratings

| Parameter | Symbol | Value | Unit |
|--|----------------|------------|-----------|
| Collector-emitter voltage | V_{CE} | 1200 | V |
| Triangular collector peak current ($V_{GE} = 15V$) $T_C = 100^\circ C, f = 32kHz$ | I_C | 8.2 | A |
| Pulsed collector current, t_p limited by T_{jmax} | I_{Cpuls} | 9 | |
| Turn off safe operating area $V_{CE} \leq 1200V, T_j \leq 150^\circ C$ | - | 9 | |
| Diode forward current $T_C = 25^\circ C$ $T_C = 100^\circ C$ | I_F | 9.6 3.9 | |
| Gate-emitter voltage | V_{GE} | ± 20 | V |
| Power dissipation $T_C = 25^\circ C$ | P_{tot} | 29 | W |
| Operating junction and storage temperature | T_j, T_{stg} | -40...+150 | °C |
| Soldering temperature, 1.6mm (0.063 in.) from case for 10s | - | 260 | |
| Isolation Voltage | V_{isol} | 2500 | V_{rms} |

¹ J-STD-020 and JESD-022

Thermal Resistance

| Parameter | Symbol | Conditions | Max. Value | Unit |
|---|-------------|------------|------------|------|
| Characteristic | | | | |
| IGBT thermal resistance, junction – case | R_{thJC} | | 4.3 | K/W |
| Diode thermal resistance, junction - case | R_{thJCD} | | 5.8 | |
| Thermal resistance, junction – ambient | R_{thJA} | | 62 | |

Electrical Characteristic, at $T_j = 25^\circ\text{C}$, unless otherwise specified

| Parameter | Symbol | Conditions | Value | | | Unit |
|--|---------------|---------------------------------------|-------|------|------|---------|
| | | | min. | Typ. | max. | |
| Static Characteristic | | | | | | |
| Collector-emitter breakdown voltage | $V_{(BR)CES}$ | $V_{GE}=0V, I_C=300\mu A$ | 1200 | - | - | V |
| Collector-emitter saturation voltage | $V_{CE(sat)}$ | $V_{GE} = 15V, I_C=3A$ | - | 2.2 | 2.8 | |
| | | $T_j=25^\circ\text{C}$ | - | 2.5 | - | |
| | | $T_j=150^\circ\text{C}$ | - | 2.4 | - | |
| Diode forward voltage | V_F | $V_{GE} = 0, I_F=3A$ | - | 1.55 | - | |
| | | $T_j=25^\circ\text{C}$ | - | 1.6 | - | |
| | | $T_j=150^\circ\text{C}$ | - | - | - | |
| Gate-emitter threshold voltage | $V_{GE(th)}$ | $I_C=90\mu A, V_{CE}=V_{GE}$ | 2.1 | 3 | 3.9 | |
| Zero gate voltage collector current | I_{CES} | $V_{CE}=1200V, V_{GE}=0V$ | - | - | 20 | μA |
| | | $T_j=150^\circ\text{C}$ | - | - | 80 | |
| Gate-emitter leakage current | I_{GES} | $V_{CE}=0V, V_{GE}=20V$ | - | - | 100 | nA |
| Transconductance | g_{fs} | $V_{CE}=20V, I_C=3A$ | - | 2 | - | S |
| Dynamic Characteristic | | | | | | |
| Input capacitance | C_{iss} | $V_{CE}=25V,$ | - | 205 | - | pF |
| Output capacitance | C_{oss} | $V_{GE}=0V,$ | - | 24 | - | |
| Reverse transfer capacitance | C_{riss} | $f=1\text{MHz}$ | - | 7 | - | |
| Gate charge | Q_{Gate} | $V_{CC}=960V, I_C=3A$ $V_{GE}=15V$ | - | 8.6 | - | nC |
| Internal emitter inductance measured 5mm (0.197 in.) from case | L_E | | - | 7 | - | nH |

Switching Characteristic, Inductive Load, at $T_j=25^\circ\text{C}$

| Parameter | Symbol | Conditions | Value | | | Unit |
|---|--------------|--|-------|------|------|------------------------|
| | | | min. | typ. | max. | |
| IGBT Characteristic | | | | | | |
| Turn-on delay time | $t_{d(on)}$ | $T_j=25^\circ\text{C}$, $V_{CC}=800\text{V}$, $I_C=3\text{A}$, $V_{GE}=0\text{V}/15\text{V}$, $R_G=82\Omega$, $L_\sigma^{(2)}=180\text{nH}$, $C_\sigma^{(2)}=40\text{pF}$ Energy losses include "tail" and diode ³⁾ reverse recovery. | - | 9.2 | - | ns |
| Rise time | t_r | | - | 5.2 | - | |
| Turn-off delay time | $t_{d(off)}$ | | - | 281 | - | |
| Fall time | t_f | | - | 29 | - | |
| Turn-on energy | E_{on} | | - | 0.14 | - | mJ |
| Turn-off energy | E_{off} | | - | 0.15 | - | |
| Total switching energy | E_{ts} | | - | 0.29 | - | |
| Anti-Parallel Diode Characteristic | | | | | | |
| Diode reverse recovery time | t_{rr} | $T_j=25^\circ\text{C}$, $V_R=800\text{V}$, $I_F=3\text{A}$, $R_G=82\Omega$ | - | 52 | - | ns |
| Diode reverse recovery charge | Q_{rr} | | - | 0.23 | - | μC |
| Diode peak reverse recovery current | I_{rrm} | | - | 9.3 | - | A |
| Diode current slope | di_F/dt | | - | 723 | - | $\text{A}/\mu\text{s}$ |

Switching Characteristic, Inductive Load, at $T_j=150^\circ\text{C}$

| Parameter | Symbol | Conditions | Value | | | Unit |
|---|--------------|---|-------|------|------|------------------------|
| | | | min. | typ. | max. | |
| IGBT Characteristic | | | | | | |
| Turn-on delay time | $t_{d(on)}$ | $T_j=150^\circ\text{C}$ $V_{CC}=800\text{V}$, $I_C=3\text{A}$, $V_{GE}=0\text{V}/15\text{V}$, $R_G=82\Omega$, $L_\sigma^{(2)}=180\text{nH}$, $C_\sigma^{(2)}=40\text{pF}$ Energy losses include "tail" and diode ³⁾ reverse recovery. | - | 9.4 | - | ns |
| Rise time | t_r | | - | 6.7 | - | |
| Turn-off delay time | $t_{d(off)}$ | | - | 340 | - | |
| Fall time | t_f | | - | 63 | - | |
| Turn-on energy | E_{on} | | - | 0.22 | - | mJ |
| Turn-off energy | E_{off} | | - | 0.26 | - | |
| Total switching energy | E_{ts} | | - | 0.48 | - | |
| Anti-Parallel Diode Characteristic | | | | | | |
| Diode reverse recovery time | t_{rr} | $T_j=150^\circ\text{C}$ $V_R=800\text{V}$, $I_F=3\text{A}$, $R_G=82\Omega$ | - | 112 | - | ns |
| Diode reverse recovery charge | Q_{rr} | | - | 0.52 | - | μC |
| Diode peak reverse recovery current | I_{rrm} | | - | 11 | - | A |
| Diode current slope | di_F/dt | | - | 661 | - | $\text{A}/\mu\text{s}$ |

²⁾ Leakage inductance L_σ and stray capacity C_σ due to dynamic test circuit in figure E

³⁾ Commutation diode from device IKP03N120H2

Switching Energy ZVT, Inductive Load

| Parameter | Symbol | Conditions | Value | | | Unit |
|----------------------------|-----------|---|-------|------|------|------|
| | | | min. | typ. | max. | |
| IGBT Characteristic | | | | | | |
| Turn-off energy | E_{off} | $V_{CC}=800V, I_C=3A,$ $V_{GE}=0V/15V,$ $R_G=82\Omega, C_r^{2)}=4nF$ $T_j=25^\circ C$ $T_j=150^\circ C$ | - | 0.05 | - | mJ |
| | | | - | 0.09 | - | |

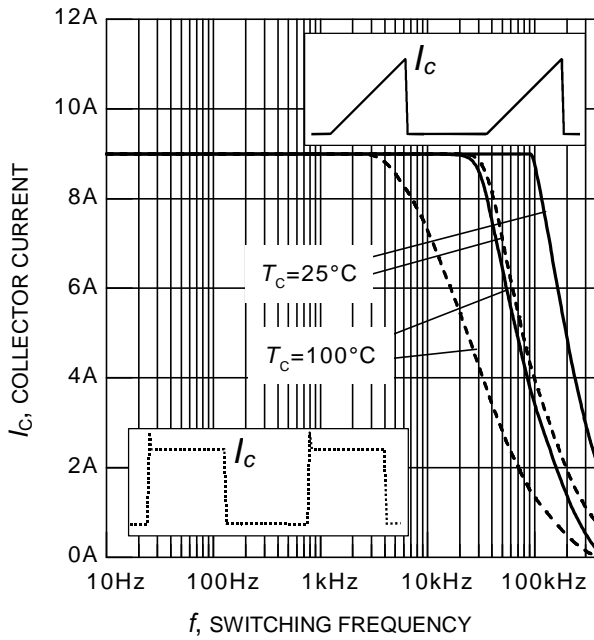

Figure 1. Collector current as a function of switching frequency
 ($T_j \leq 150^\circ\text{C}$, $D = 0.5$, $V_{CE} = 800\text{V}$,
 $V_{GE} = +15\text{V}/0\text{V}$, $R_G = 82\Omega$)

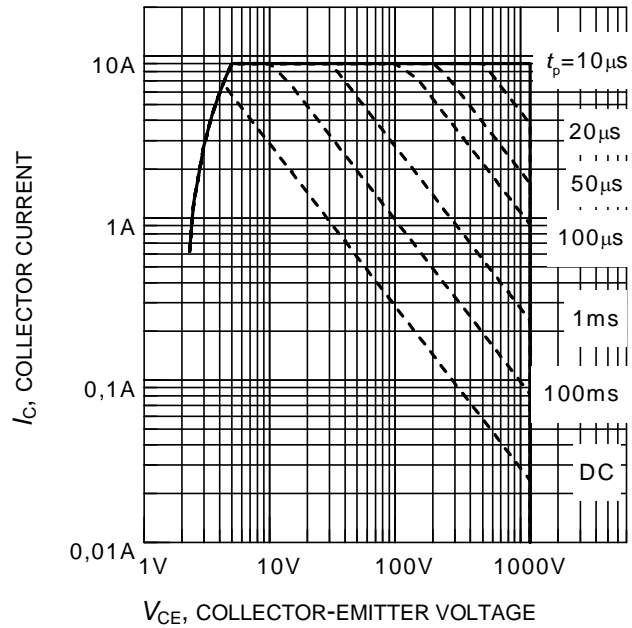

Figure 2. Safe operating area
 ($D = 0$, $T_C = 25^\circ\text{C}$, $T_j \leq 150^\circ\text{C}$)

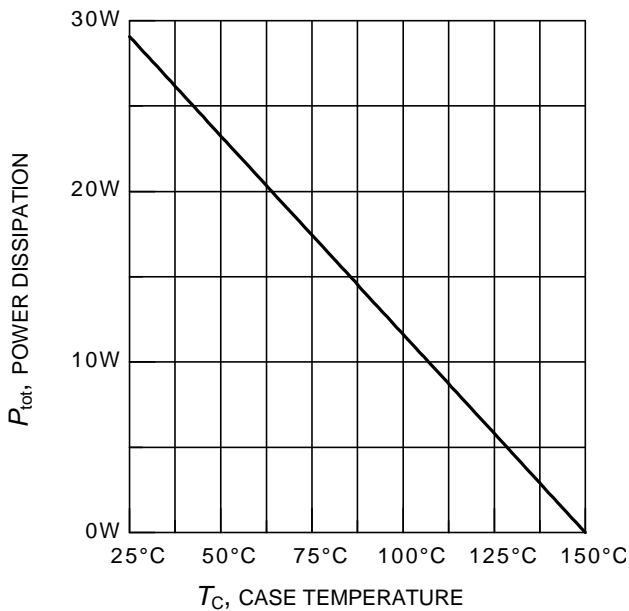

Figure 3. Power dissipation as a function of case temperature
 ($T_j \leq 150^\circ\text{C}$)

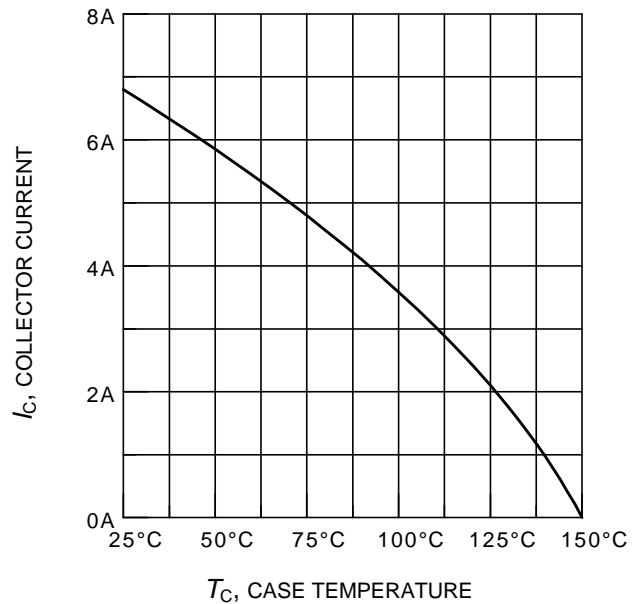

Figure 4. Collector current as a function of case temperature
 ($V_{GE} \leq 15\text{V}$, $T_j \leq 150^\circ\text{C}$)

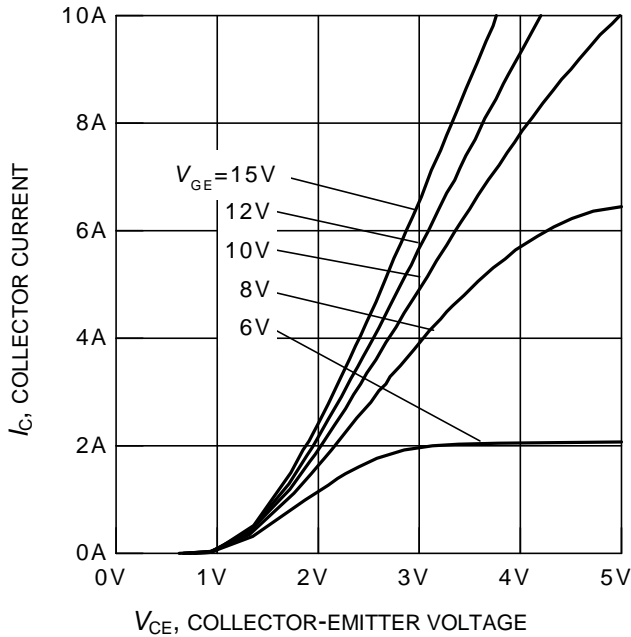

Figure 5. Typical output characteristics
($T_j = 25^\circ\text{C}$)

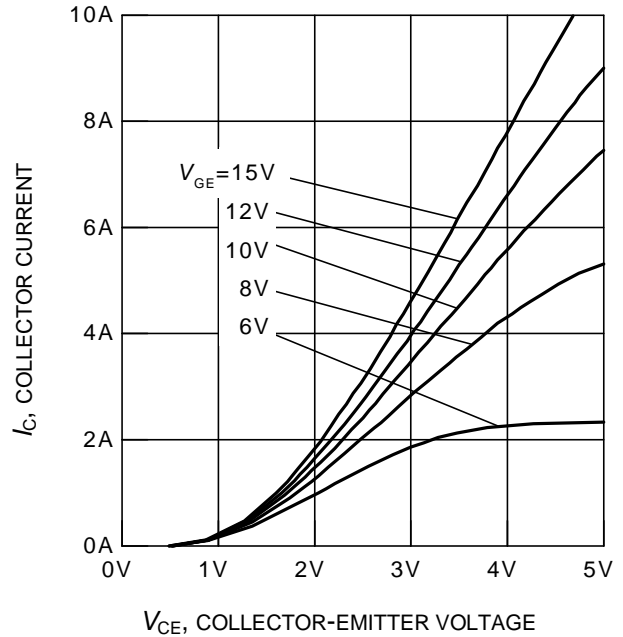

Figure 6. Typical output characteristics
($T_j = 150^\circ\text{C}$)

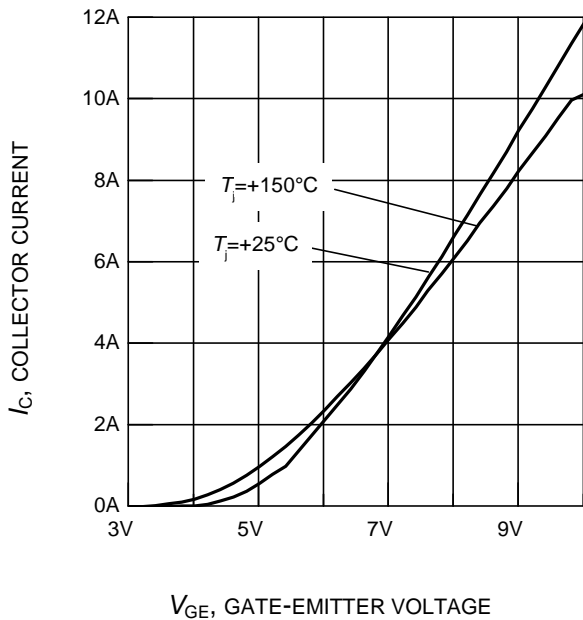

Figure 7. Typical transfer characteristics
($V_{CE} = 20\text{V}$)

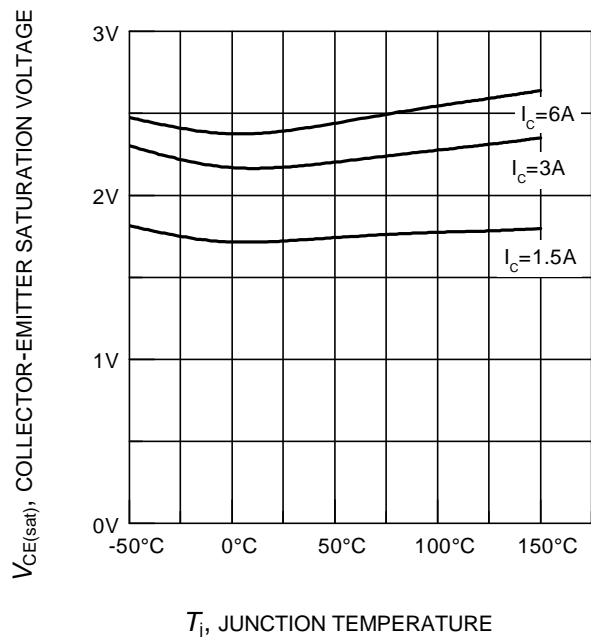

Figure 8. Typical collector-emitter saturation voltage as a function of junction temperature
($V_{GE} = 15\text{V}$)



 I_C , COLLECTOR CURRENT

Figure 9. Typical switching times as a function of collector current

 (inductive load, $T_j = 150^\circ\text{C}$,
 $V_{CE} = 800\text{V}$, $V_{GE} = +15\text{V}/0\text{V}$, $R_G = 82\Omega$,
 dynamic test circuit in Fig.E)

 R_G , GATE RESISTOR

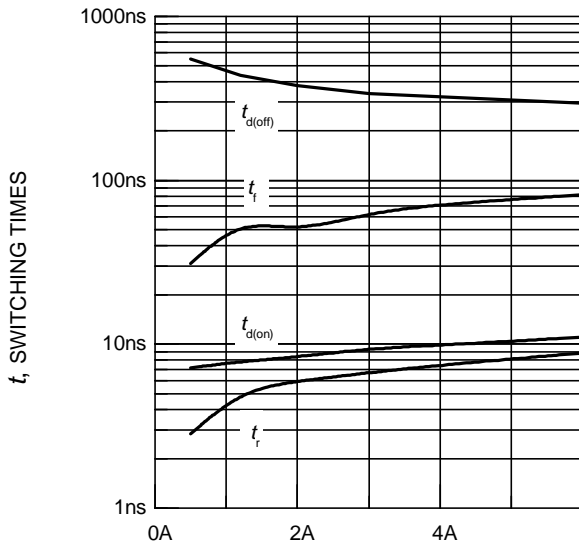
Figure 10. Typical switching times as a function of gate resistor

 (inductive load, $T_j = 150^\circ\text{C}$,
 $V_{CE} = 800\text{V}$, $V_{GE} = +15\text{V}/0\text{V}$, $I_C = 3\text{A}$,
 dynamic test circuit in Fig.E)

 T_j , JUNCTION TEMPERATURE

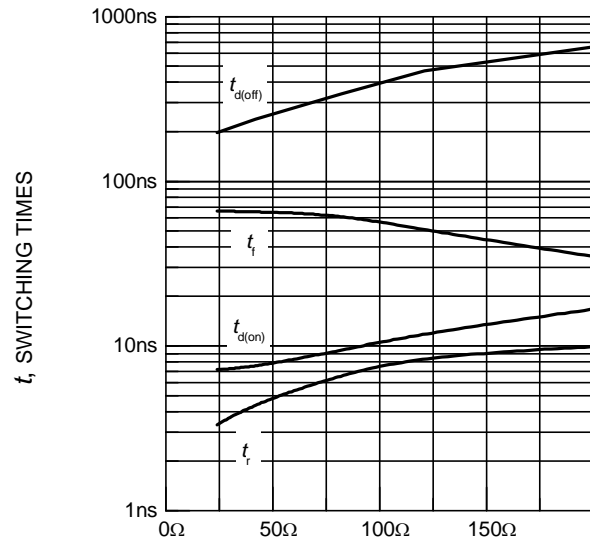
Figure 11. Typical switching times as a function of junction temperature

 (inductive load, $V_{CE} = 800\text{V}$,
 $V_{GE} = +15\text{V}/0\text{V}$, $I_C = 3\text{A}$, $R_G = 82\Omega$,
 dynamic test circuit in Fig.E)

 T_j , JUNCTION TEMPERATURE

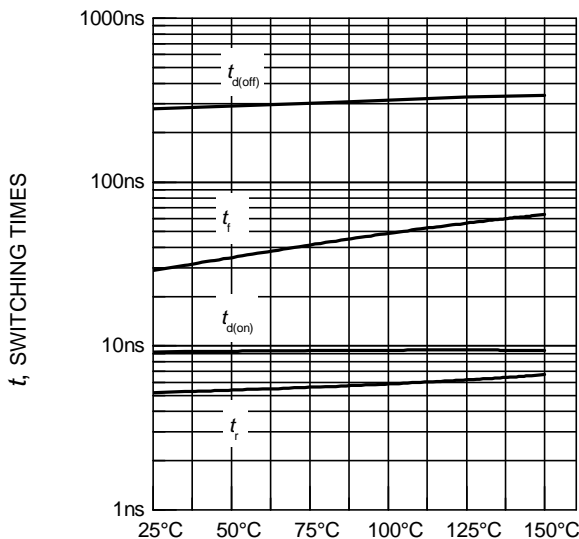
Figure 12. Gate-emitter threshold voltage as a function of junction temperature

 ($I_C = 0.09\text{mA}$)

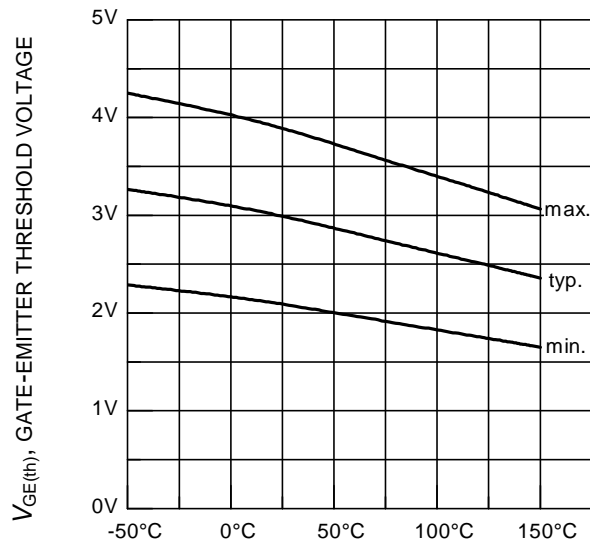
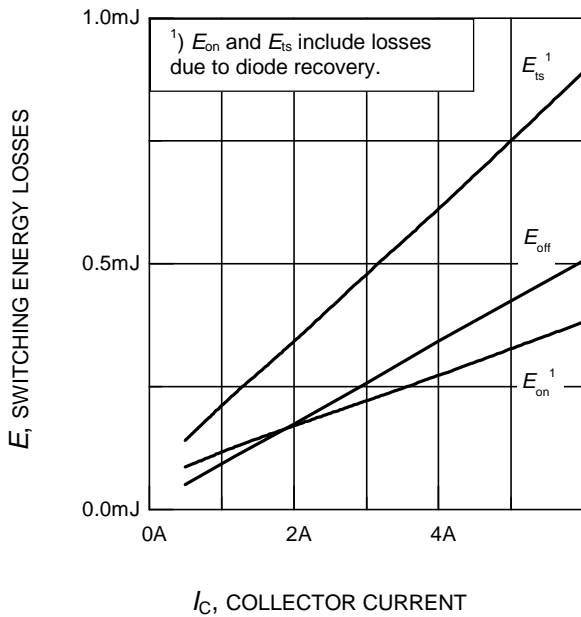

Figure 13. Typical switching energy losses as a function of collector current
 (inductive load, $T_j = 150^\circ\text{C}$, $V_{CE} = 800\text{V}$, $V_{GE} = +15\text{V}/0\text{V}$, $R_G = 82\Omega$, dynamic test circuit in Fig.E)

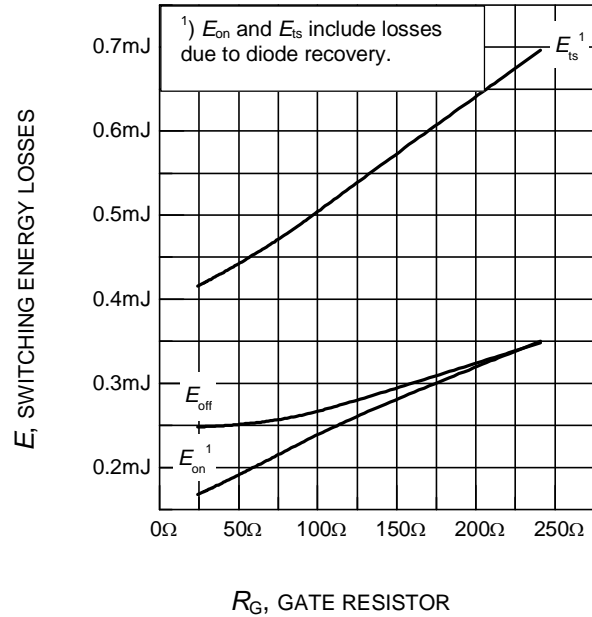

Figure 14. Typical switching energy losses as a function of gate resistor
 (inductive load, $T_j = 150^\circ\text{C}$, $V_{CE} = 800\text{V}$, $V_{GE} = +15\text{V}/0\text{V}$, $I_C = 3\text{A}$, dynamic test circuit in Fig.E)

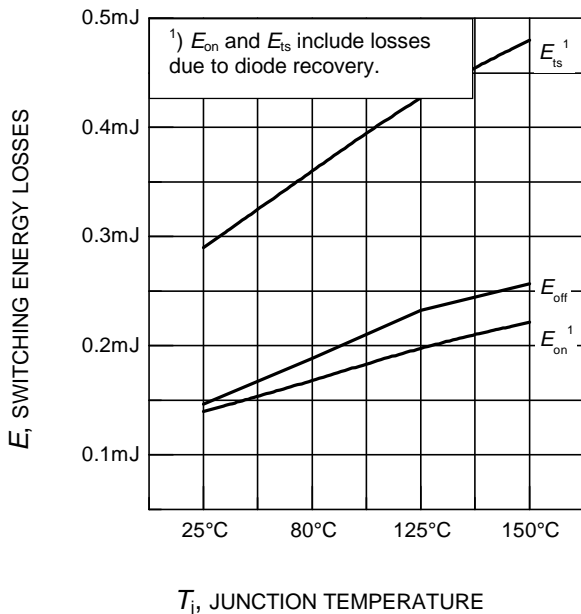

Figure 15. Typical switching energy losses as a function of junction temperature
 (inductive load, $V_{CE} = 800\text{V}$, $V_{GE} = +15\text{V}/0\text{V}$, $I_C = 3\text{A}$, $R_G = 82\Omega$, dynamic test circuit in Fig.E)

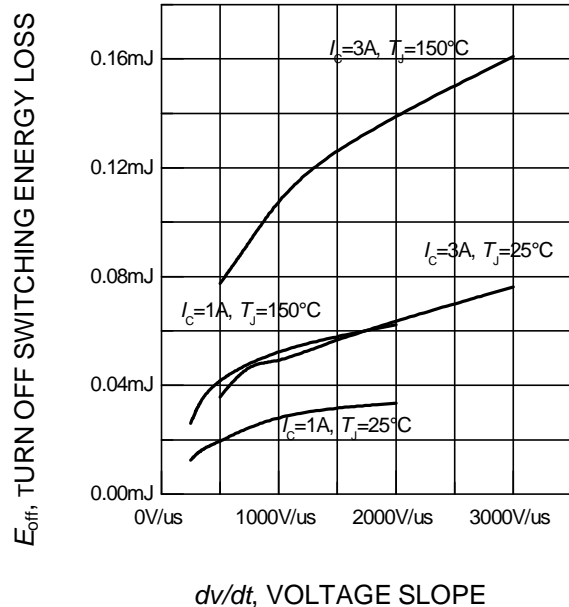
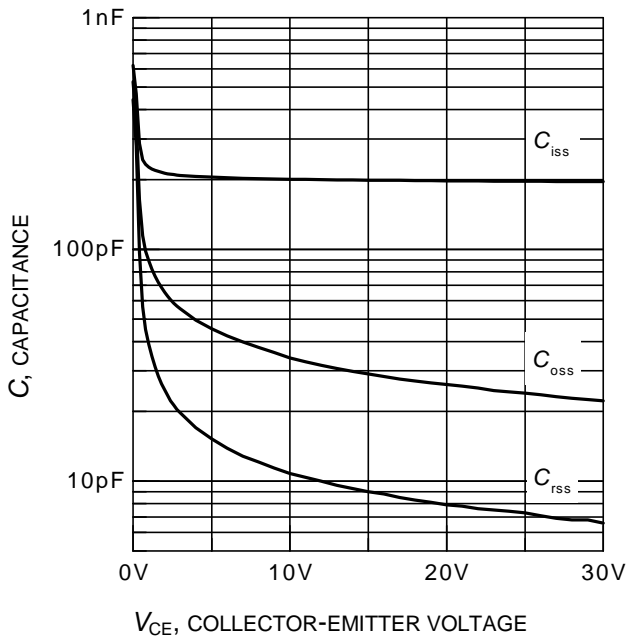
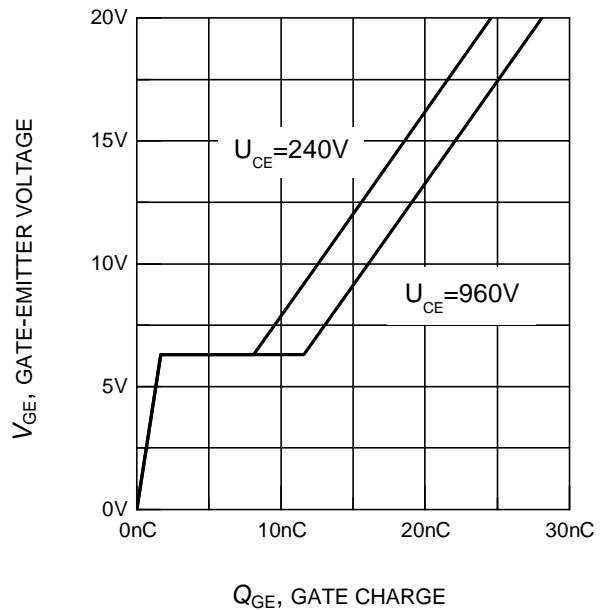

Figure 16. Typical turn off switching energy loss for soft switching
 (dynamic test circuit in Fig. E)



V_{CE} , COLLECTOR-EMITTER VOLTAGE
Figure 17. Typical capacitance as a function of collector-emitter voltage
 ($V_{GE} = 0V$, $f = 1MHz$)



Q_{GE} , GATE CHARGE
Figure 18. Typical gate charge
 ($I_C = 3A$)

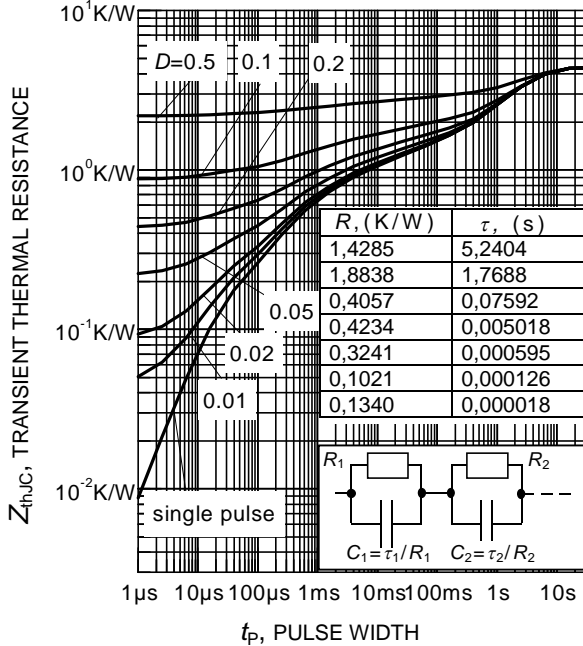

t_p , PULSE WIDTH
Figure 19. Typical IGBT transient thermal impedance as a function of pulse width
 ($D = t_p/T$)

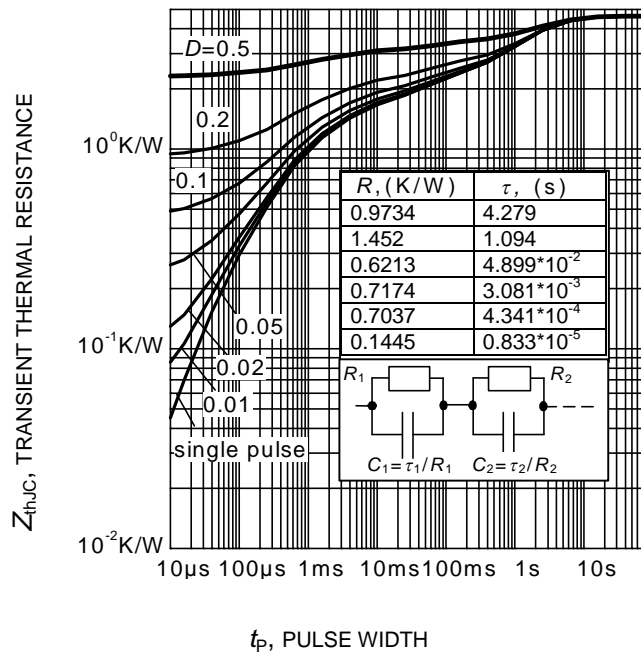

t_p , PULSE WIDTH
Figure 22. Typical Diode transient thermal impedance as a function of pulse width
 ($D = t_p/T$)

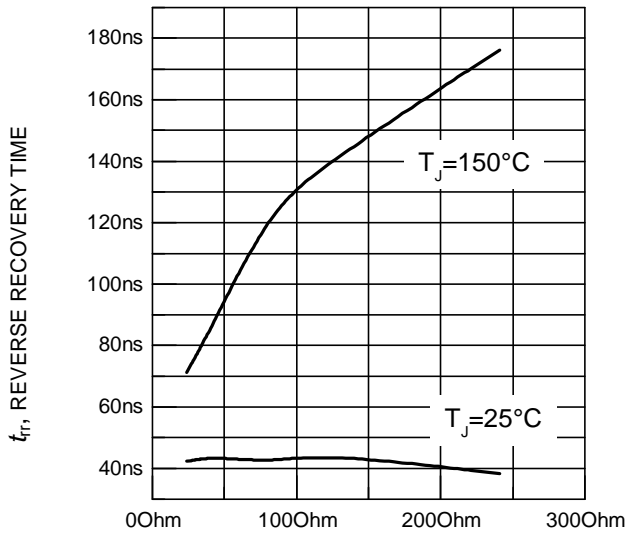

R_G , GATE RESISTANCE

Figure 23. Typical reverse recovery time as a function of diode current slope
 $V_R=800V$, $I_F=3A$,
 Dynamic test circuit in Figure E)

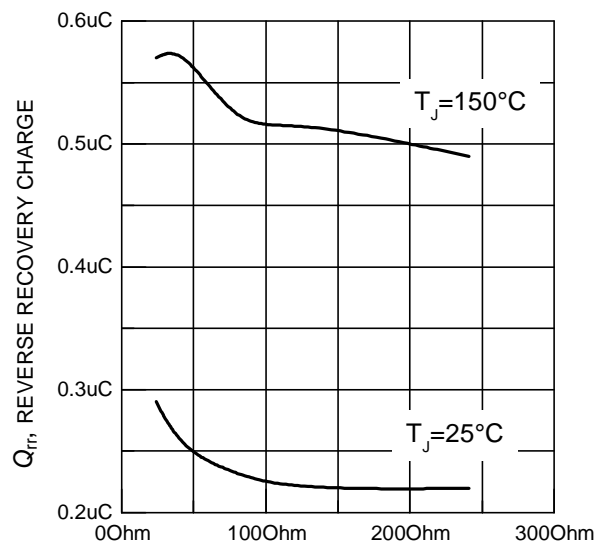

R_G , GATE RESISTANCE

Figure 24. Typical reverse recovery charge as a function of diode current slope
 $(V_R=800V, I_F=3A,$
 Dynamic test circuit in Figure E)

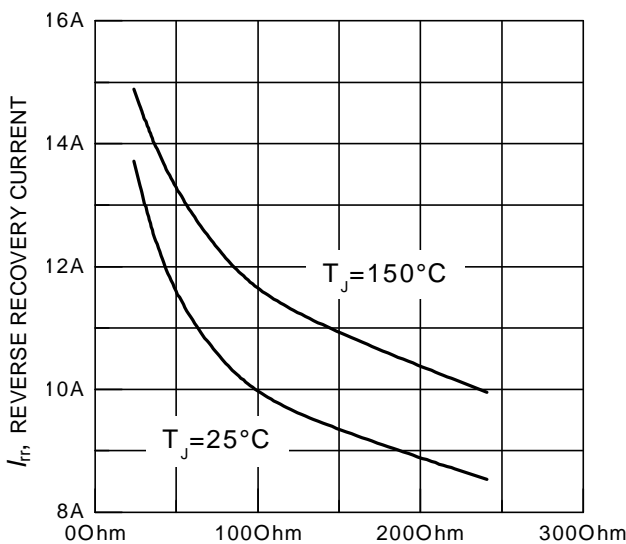

R_G , GATE RESISTANCE

Figure 25. Typical reverse recovery current as a function of diode current slope
 $(V_R=800V, I_F=3A,$
 Dynamic test circuit in Figure E)

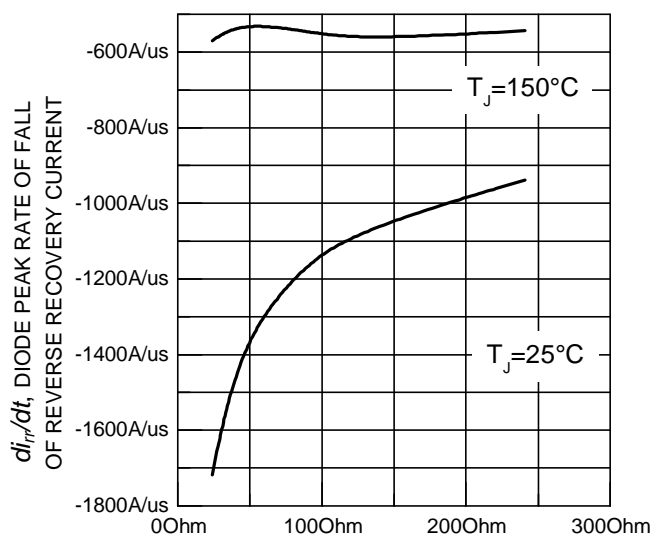

R_G , GATE RESISTANCE

Figure 26. Typical diode peak rate of fall of reverse recovery current as a function of diode current slope
 $(V_R=800V, I_F=3A,$
 Dynamic test circuit in Figure E)

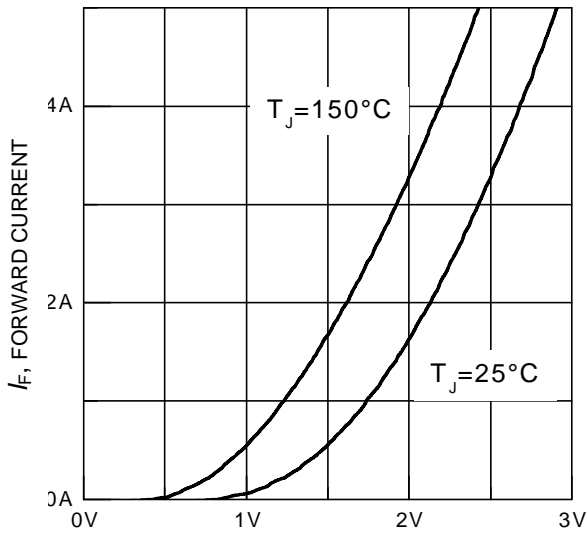

V_F , FORWARD VOLTAGE

Figure 27. Typical diode forward current as a function of forward voltage

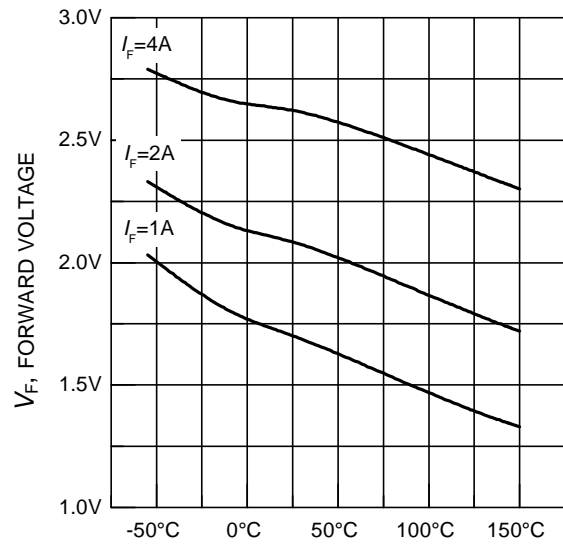

T_J , JUNCTION TEMPERATURE

Figure 28. Typical diode forward voltage as a function of junction temperature

TO-220-3-FP

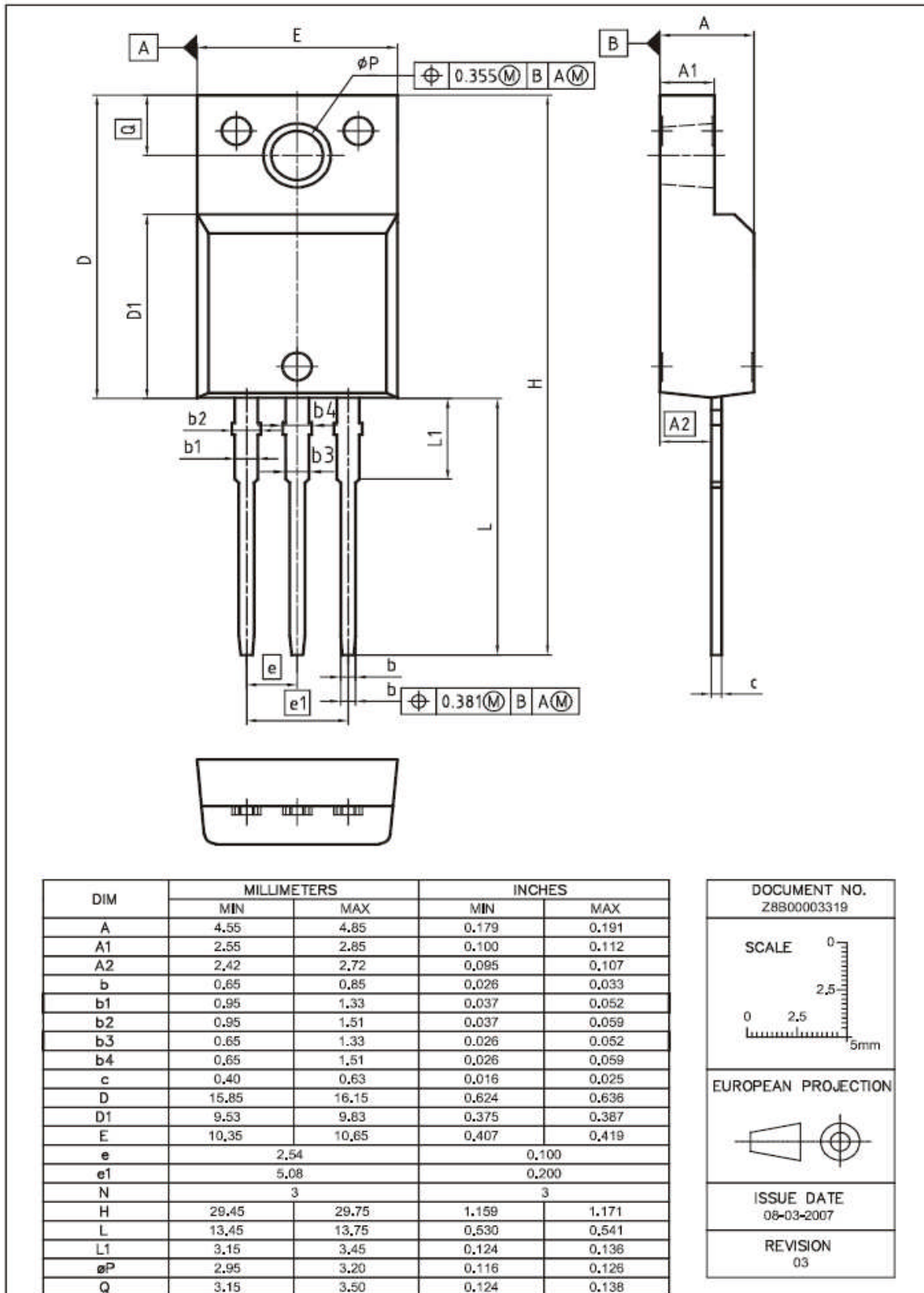

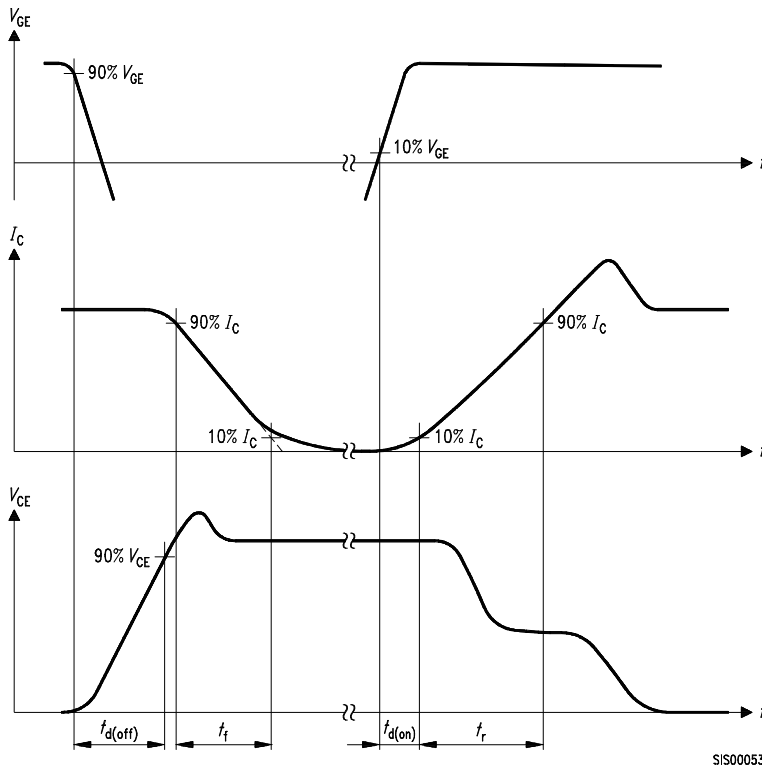
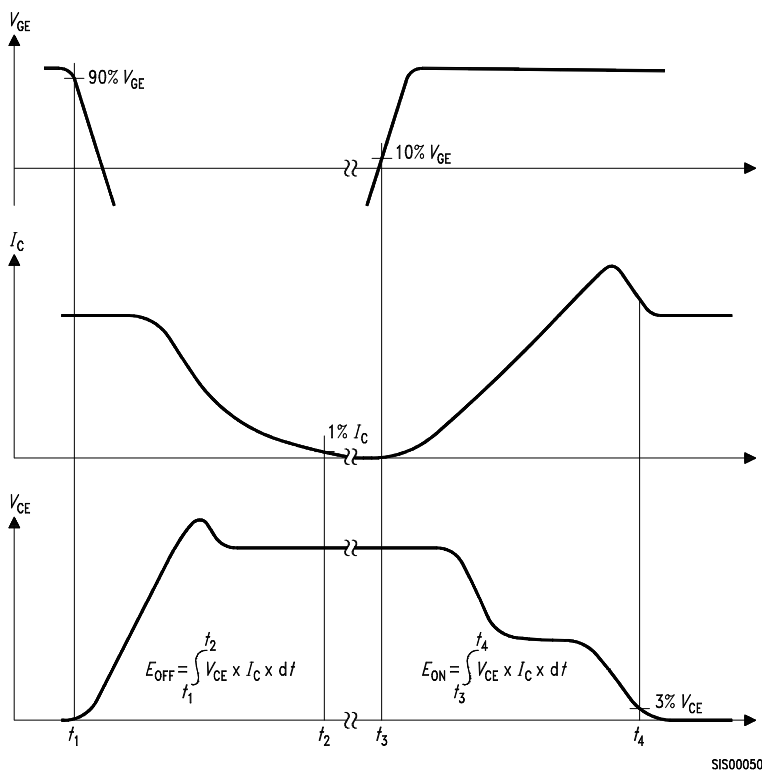
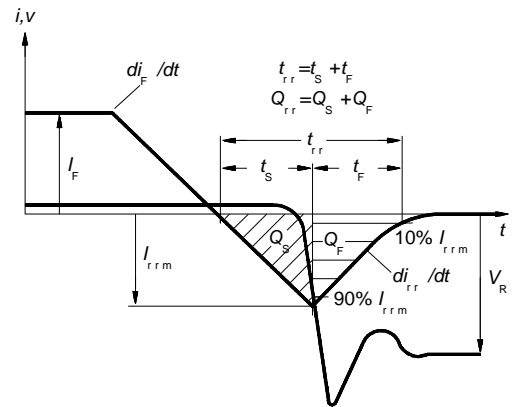
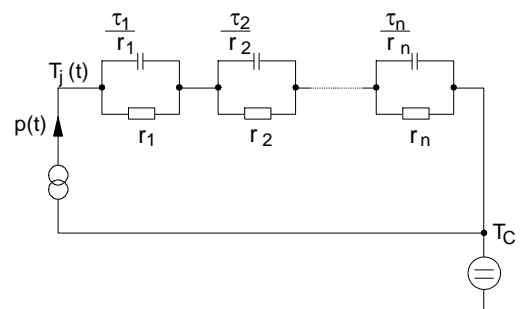
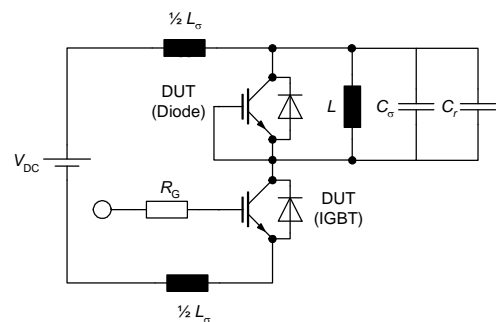
Figure A. Definition of switching times

Figure B. Definition of switching losses

Figure C. Definition of diodes switching characteristics

Figure D. Thermal equivalent circuit

Figure E. Dynamic test circuit
 Leakage inductance $L_{\sigma} = 180\text{nH}$,
 Stray capacitor $C_{\sigma} = 40\text{pF}$,
 Relief capacitor $C_r = 4\text{nF}$ (only for ZVT switching)

Published by
Infineon Technologies AG
81726 Munich, Germany
© 2013 Infineon Technologies AG
All Rights Reserved.

Legal Disclaimer

The information given in this document shall in no event be regarded as a guarantee of conditions or characteristics. With respect to any examples or hints given herein, any typical values stated herein and/or any information regarding the application of the device, Infineon Technologies hereby disclaims any and all warranties and liabilities of any kind, including without limitation, warranties of non-infringement of intellectual property rights of any third party.

Information

For further information on technology, delivery terms and conditions and prices, please contact the nearest Infineon Technologies Office (www.infineon.com).

Warnings

Due to technical requirements, components may contain dangerous substances. For information on the types in question, please contact the nearest Infineon Technologies Office.

The Infineon Technologies component described in this Data Sheet may be used in life-support devices or systems and/or automotive, aviation and aerospace applications or systems only with the express written approval of Infineon Technologies, if a failure of such components can reasonably be expected to cause the failure of that life-support, automotive, aviation and aerospace device or system or to affect the safety or effectiveness of that device or system. Life support devices or systems are intended to be implanted in the human body or to support and/or maintain and sustain and/or protect human life. If they fail, it is reasonable to assume that the health of the user or other persons may be endangered.