

K101 • K102 • K104

These Photocouplers consist of a Gallium Arsenide Infrared Emitting Diode and a Silicon NPN Phototransistor per a channel.

The K101 has one channel in a 4-pin mini-flat SMD package.

The K102 has two channels in a 8-pin mini-flat SMD package.

The K104 has four channels in a 16-pin mini-flat SMD package.

FEATURES

- Mini-Flat Package
- Collector-Emitter Voltage : Min.50V
- Current Transfer Ratio : Min.50% (at $I_F=5mA$, $V_{CE}=5V$)
- Electrical Isolation Voltage : AC3750V_{rms}

APPLICATIONS

- Interface between two circuits of different potential
- Cordless Phone
- Programmable Logic Control
- Microcomputer

DIMENSION

(Unit : mm)

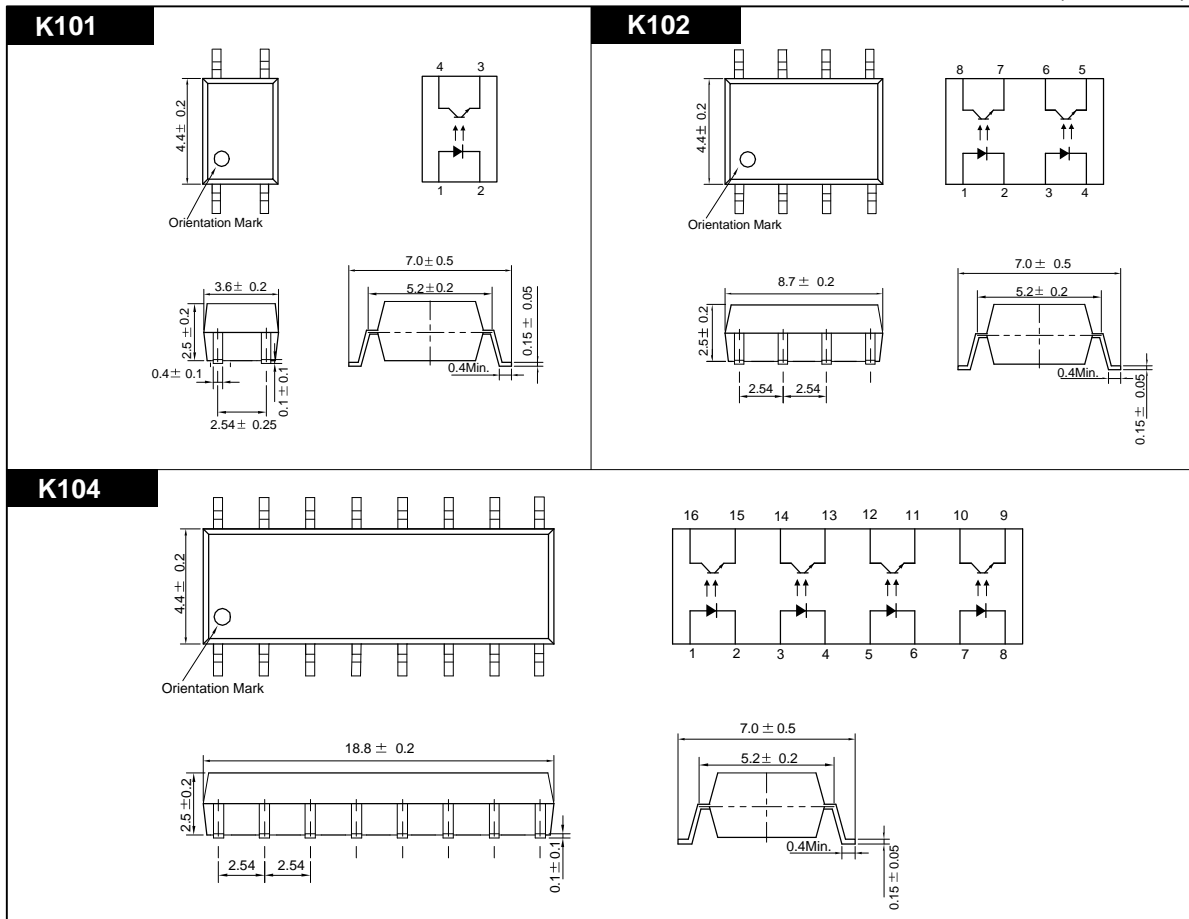

K101 • K102 • K104

MAXIMUM RATINGS

(Ta=25)

Parameter		Symbol	Rating	Unit
Input	Forward Current	IF	50	mA
	Reverse Voltage	VR	5	V
	Peak Forward Current ^{*1}	IFP	1	A
	Power Dissipation	PD	70	mW
Output	Collector-Emitter Breakdown Voltage	BVCEO	50	V
	Emitter-Collector Breakdown Voltage	BVECO	6	V
	Collector Current	IC	50	mA
	Collector Power Dissipation	PC	150	mW
Input to Output Isolation Voltage ^{*2}		Viso	AC3750	Vrms
Storage Temperature		Tstg	-55~+125	
Operating Temperature		Topr	-30~+100	
Lead Soldering Temperature ^{*3}		Tsol	260	
Total Power Dissipation		Ptot	200	mW

*1. Input current with 100μs pulse width, 1% duty cycle

*2. Measured at RH=40~60% for 1min

*3. 1/16 inch form case for 10sec

ELECTRO-OPTICAL CHARACTERISTICS

(Ta=25 , unless otherwise noted)

Parameter		Symbol	Condition	Min.	Typ.	Max.	Unit.
Input	Forward Voltage	VF	IF=10mA	-	1.15	1.30	V
	Reverse Current	IR	VR=5V	-	-	10	μA
	Capacitance	CT	V=0, f=1MHz	-	30	-	pF
Output	Collector-Emitter Breakdown Voltage	BVCEO	IC=0.5mA	50	-	-	V
	Emitter-Collector Breakdown Voltage	BVECO	IE=0.1mA	6	-	-	V
	Collector Dark Current	ICEO	IF=0, VCE=24V	-	-	100	nA
	Capacitance	CCE	VCE=0, f=1MHz	-	10	-	pF
Coupled	Current Transfer Ratio ^{*4}	CTR	IF=5mA, VCE=5V	50	-	600	%
	Collector-Emitter Saturation Voltage	VCE(SAT)	IF=5mA, IC=1mA	-	0.15	0.4	V
	Input-Output Capacitance	CIO	V=0, f=1MHz	-	1	-	pF
	Input-Output Isolation Resistance	RIO	RH=40~60%, V=500V	-	10 ¹¹	-	
	Rise Time	tr	VCE=5V, RL=100	-	3	-	μs
	Fall Time	tf	IC=2mA	-	3	-	μs

*4. CTR=(IC/IF) X 100 (%)

K101 • K102 • K104

Forward Current vs. Ambient Temperature

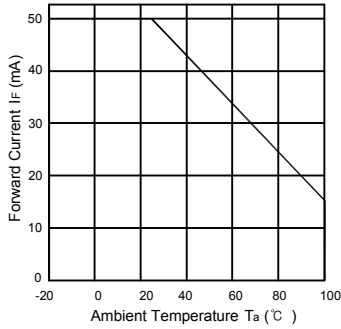

Collector Power Dissipation vs. Ambient Temperature

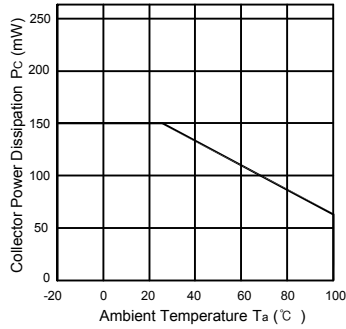

Forward Current vs. Forward Voltage

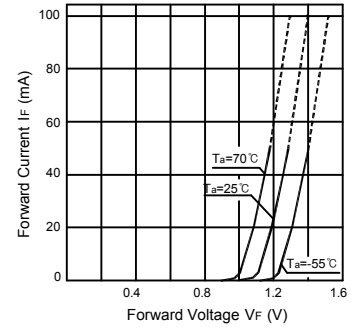

Collector Current vs. Collector-Emitter Voltage

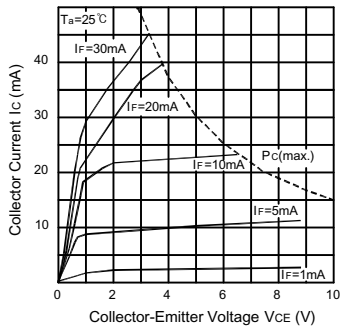

Dark Current vs. Ambient Temperature

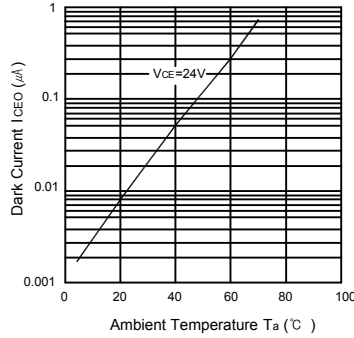

Collector Current vs. Ambient Temperature

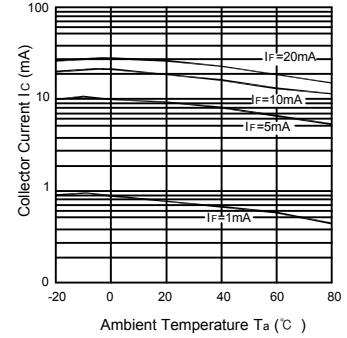

Response Time vs. Load Resistance

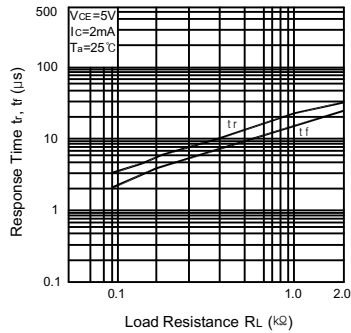

Collector Current vs. Forward Current

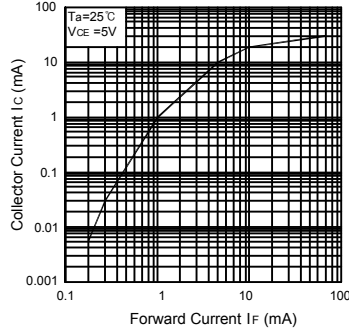

Switching Time Test Circuit

