

N-CHANNEL MOS FIELD EFFECT POWER TRANSISTORS
2SK1495, 2SK1495-Z/2SK1496, 2SK1496-Z

SWITCHING
N-CHANNEL POWER MOS FET
INDUSTRIAL USE

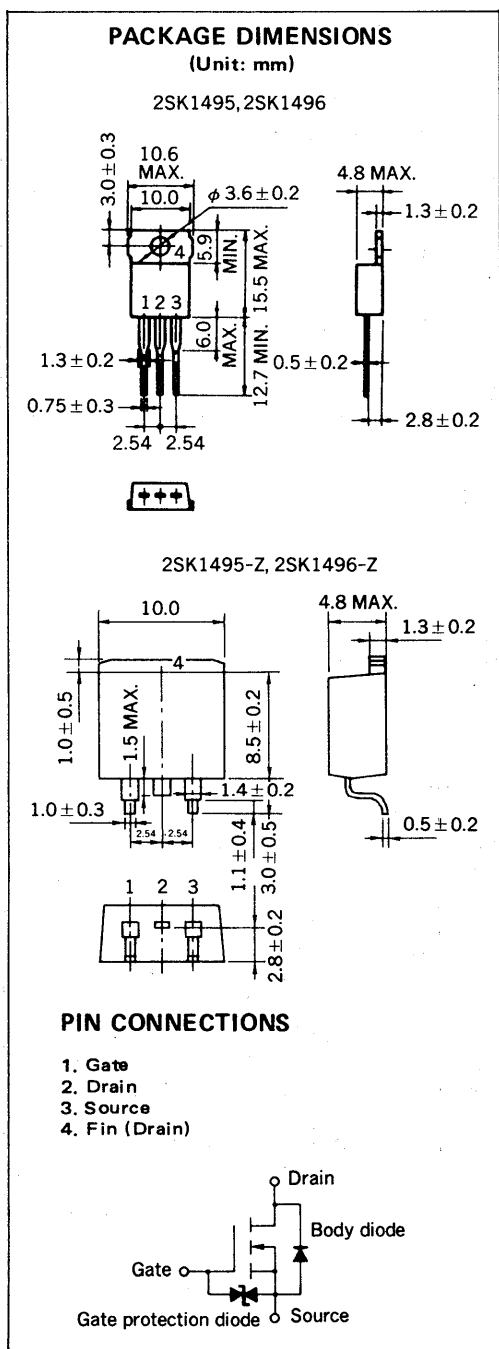

DESCRIPTION

The 2SK1495/2SK1496 is N-channel MOS Field Effect Transistor designed for high voltage switching applications.

FEATURES

- Low On-state Resistance
 $R_{DS(on)} = 0.9 \Omega \text{ MAX.}/1.0 \Omega \text{ MAX.}$ ($V_{GS} = 10 \text{ V}$, $I_D = 4 \text{ A}$)
- Low C_{iss} $C_{iss} = 1060 \text{ pF TYP.}$
- Built-in G-S Gate Protection Diodes
- High Avalanche Capability Ratings

ABSOLUTE MAXIMUM RATINGS

Maximum Temperatures

Storage Temperature	T_{stg}	-55 to +150	°C
Channel Temperature	T_{ch}	150	°C MAX.

Maximum Power Dissipation

Total Power Dissipation ($T_A = 25 \text{ °C}$)	P_T	70	W
---	-------	----	---

Maximum Voltages and Currents ($T_A = 25 \text{ °C}$)

Drain to Source Voltage	V_{DSS}	450/500	V
(2SK1495/2SK1496)			
Gate to Source Voltage	V_{GSS}	±30	V
Drain Current (DC)	$I_{D(DC)}$	±7	A
Drain Current (pulse)	$I_{D(pulse)}^*$	±28	A

* $PW \leq 10 \mu s$, Duty Cycle $\leq 1 \%$

Maximum Avalanche Capability Ratings**

Single Avalanche Current	I_{AS}	10.5	A
Single Avalanche Energy	E_{AS}	206	mJ

** Starting $T_{ch} = 25 \text{ °C}$, $R_G = 25 \Omega$, $V_{GS} = 20 \text{ V} \rightarrow 0$

ELECTRICAL CHARACTERISTICS (T_A = 25 °C)

CHARACTERISTIC	SYMBOL	MIN.	TYP.	MAX.	UNIT	TEST CONDITIONS
Drain to Source On-state Resistance (2SK1493/2SK1494)	R _{DS(on)}		0.7/0.8	0.9/1.0	Ω	V _{GS} = 10 V, I _D = 4 A
Gate to Source Cutoff Voltage	V _{GS(off)}	2.5		3.5	V	V _{DS} = 10 V, I _D = 1 mA
Forward Transfer Admittance	y _{fs}	3.0			S	V _{DS} = 10 V, I _D = 4 A
Drain Leakage Current	I _{DSS}			100	μA	V _{DS} = 450V/500V, V _{GS} = 0
Gate to Source Leakage Current	I _{GSS}			±10	μA	V _{GS} = ±30 V, V _{DS} = 0
Input Capacitance	C _{iss}		1 060		pF	V _{DS} = 10 V
Output Capacitance	C _{oss}		340		pF	V _{GS} = 0
Reverse Transfer Capacitance	C _{rss}		150		pF	f = 1 MHz
Turn-On Delay Time	t _{d(on)}		20		ns	V _{GS} = 10 V
Rise Time	t _r		30		ns	V _{DD} = 150 V
Turn-Off Delay Time	t _{d(off)}		70		ns	I _D = 4 A, R _G = 10 Ω
Fall Time	t _f		20		ns	R _L = 37.5 Ω
Total Gate Charge	Q _G		36		nC	V _{GS} = 10 V
Gate to Source Charge	Q _{GS}		7		nC	I _D = 7 A
Gate to Drain Charge	Q _{GD}		21		nC	V _{DD} = 400 V
Diode Forward Voltage	V _{F(S-D)}		1.0		V	I _F = 7 A, V _{GS} = 0
Reverse Recovery Time	t _{rr}		420		ns	I _F = 7 A
Reverse Recovery Charge	Q _{rr}		2.1		μC	di/dt = 50 A/μs

Test Circuit 1: Avalanche Capability

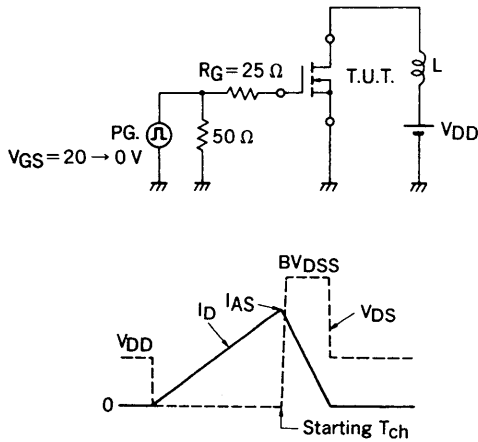

Test Circuit 2: Switching Time

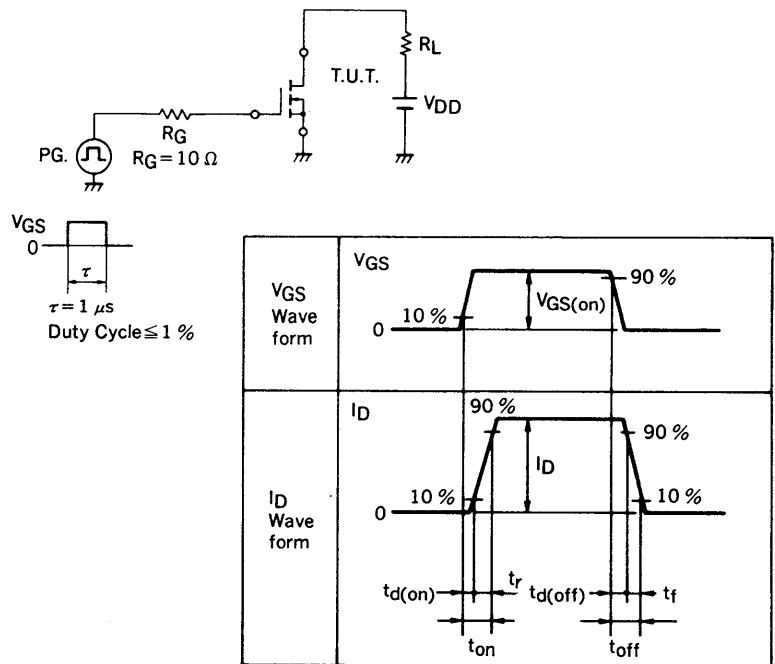

Test Circuit 3: Gate Charge

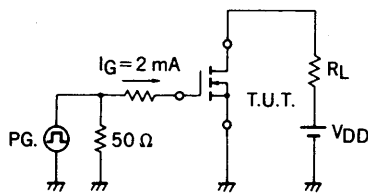

TYPICAL CHARACTERISTICS ($T_A = 25^\circ\text{C}$)

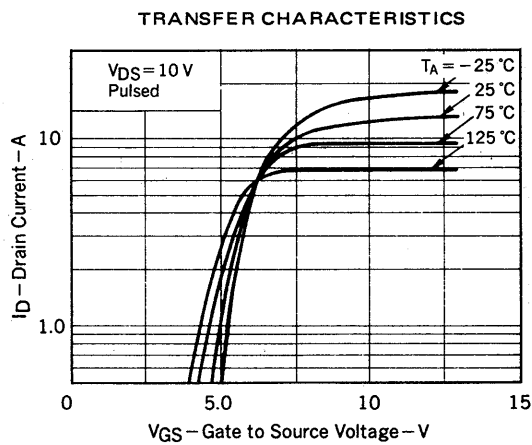
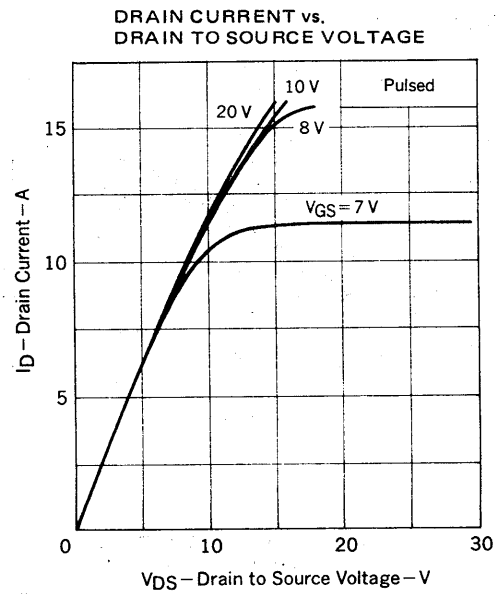
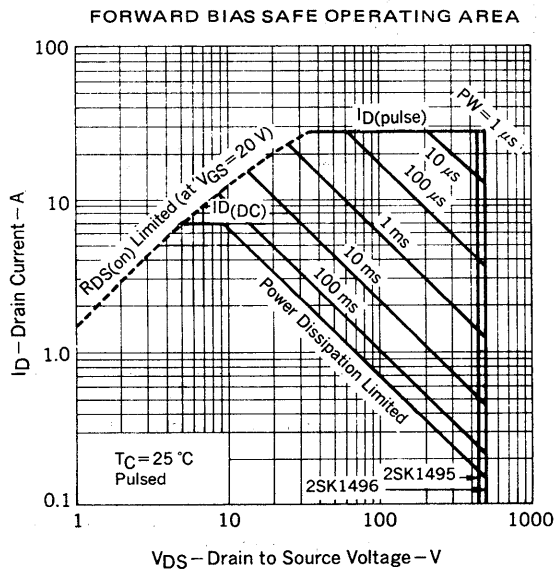
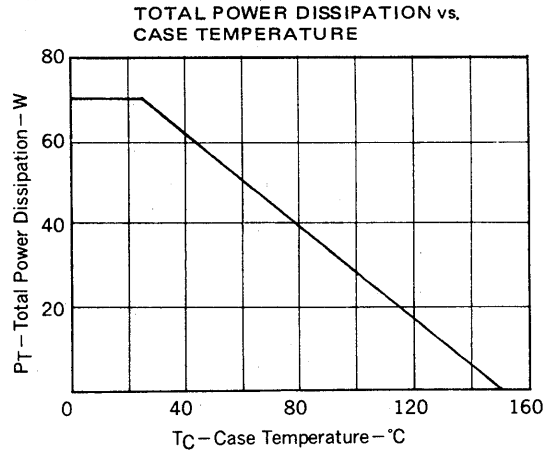
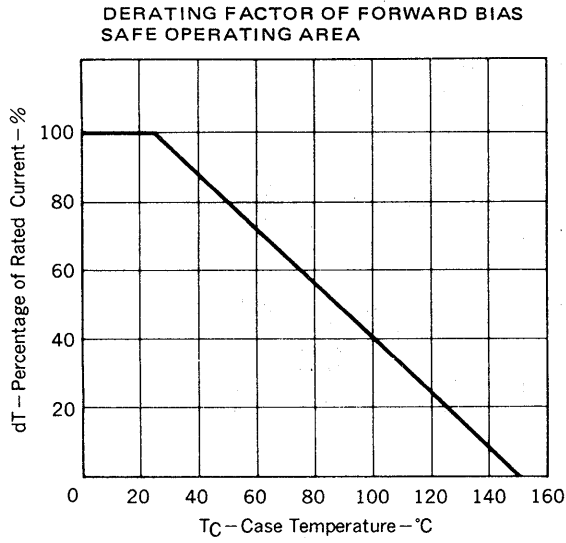

TRANSIENT THERMAL RESISTANCE vs. PULSE WIDTH

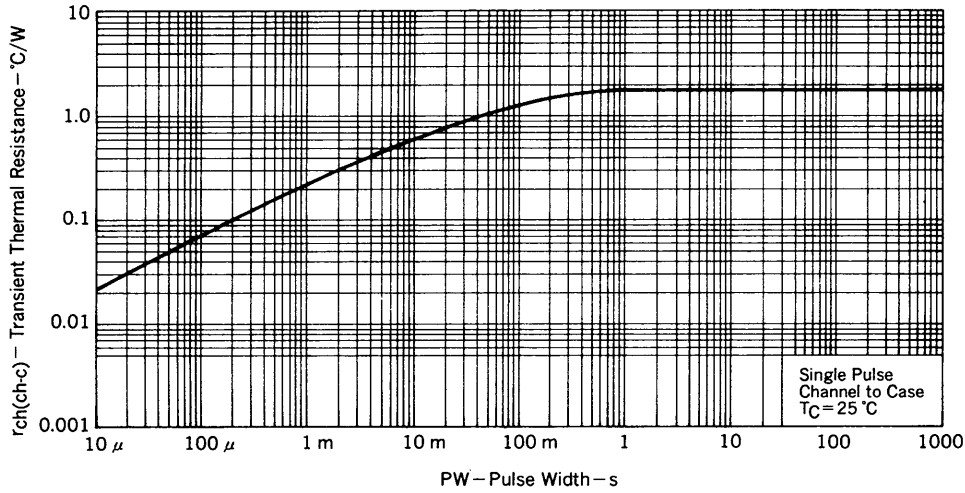

FORWARD TRANSFER ADMITTANCE vs. DRAIN CURRENT

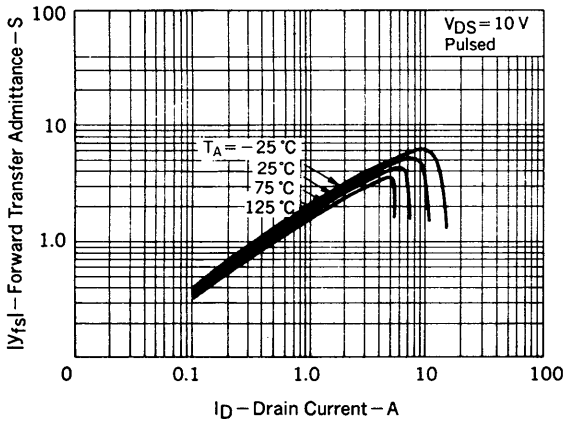

DRAIN TO SOURCE ON-STATE RESISTANCE vs. GATE TO SOURCE VOLTAGE

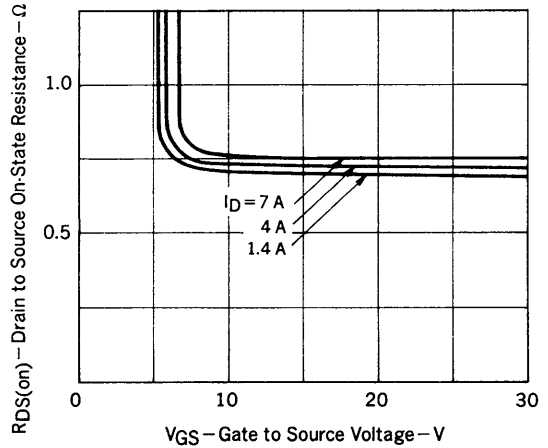

DRAIN TO SOURCE ON-STATE RESISTANCE vs. DRAIN CURRENT

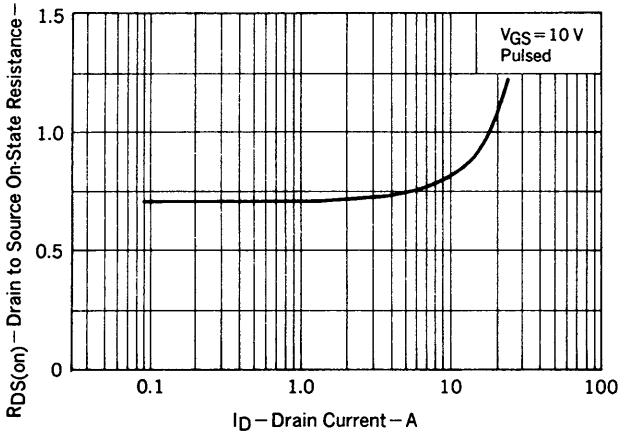

GATE TO SOURCE CUTOFF VOLTAGE vs. CHANNEL TEMPERATURE

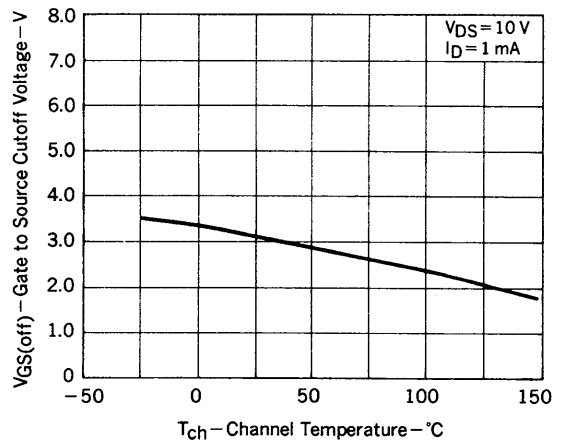

DRAIN TO SOURCE ON-STATE RESISTANCE vs. CHANNEL TEMPERATURE

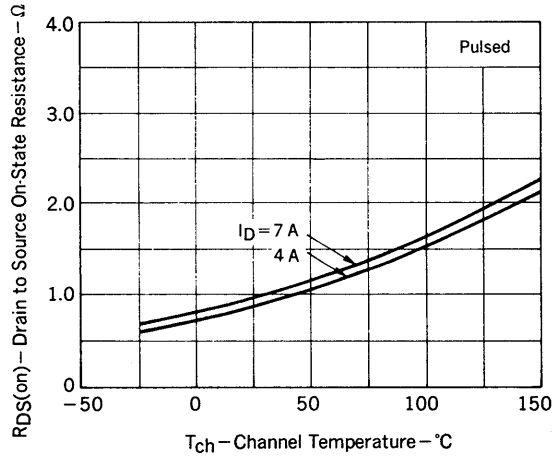

SOURCE TO DRAIN DIODE FORWARD VOLTAGE

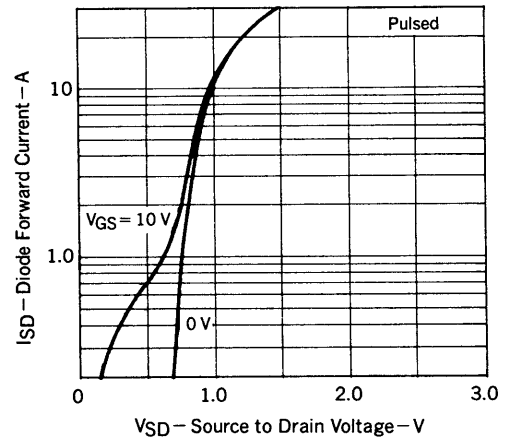

CAPACITANCE vs. DRAIN TO SOURCE VOLTAGE

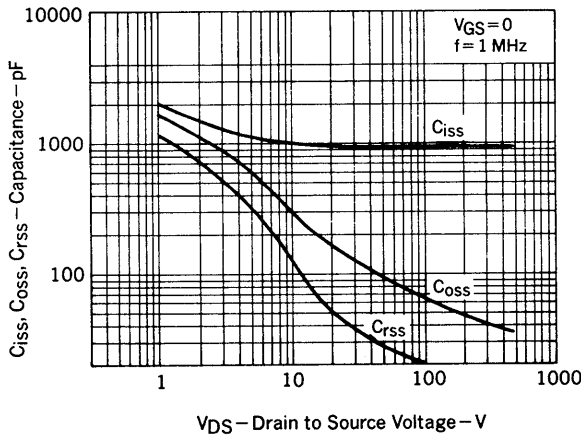

SWITCHING CHARACTERISTICS

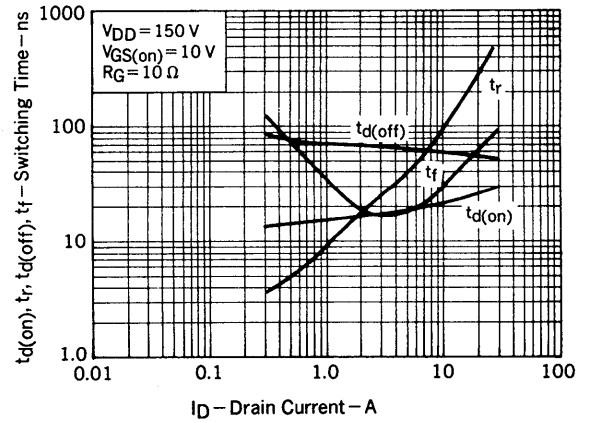

DYNAMIC INPUT CHARACTERISTICS

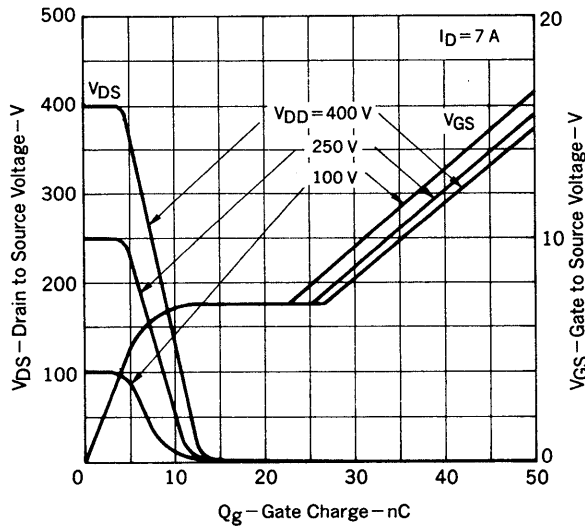

REVERSE RECOVERY TIME vs. DIODE FORWARD CURRENT

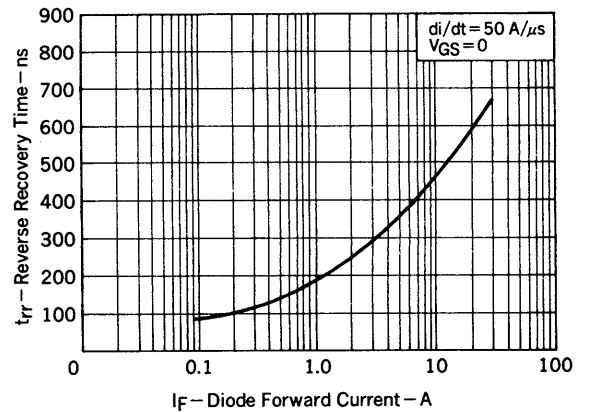

SINGLE AVALANCHE CURRENT vs. INDUCTIVE LOAD

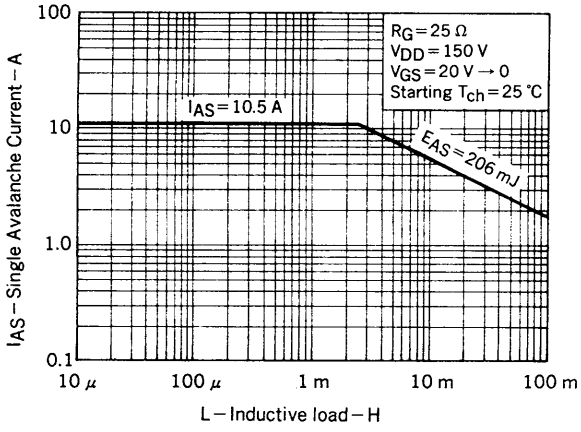

SINGLE AVALANCHE ENERGY vs. STARTING CHANNEL TEMPERATURE

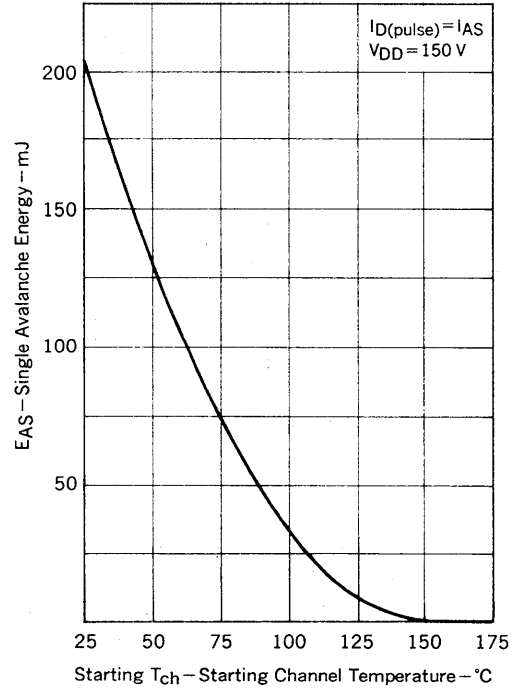

REFERENCE

Application note name	No.
Safe operating area of Power MOS FET.	TEA-1037
Application circuit using Power MOS FET.	TEA-1035
Guide to quality assurance for semiconductor device.	MEI-1202
Power MOS FET features and application switching power supply	TEA-1034

[MEMO]

No part of this document may be copied or reproduced in any form or by any means without the prior written consent of NEC Corporation. NEC Corporation assumes no responsibility for any errors which may appear in this document.

NEC Corporation does not assume any liability for infringement of patents, copyrights or other intellectual property rights of third parties by or arising from use of a device described herein or any other liability arising from use of such device. No license, either express, implied or otherwise, is granted under any patents, copyrights or other intellectual property rights of NEC Corporation or others.

While NEC Corporation has been making continuous effort to enhance the reliability of its semiconductor devices, the possibility of defects cannot be eliminated entirely. To minimize risks of damage or injury to persons or property arising from a defect in an NEC semiconductor device, customers must incorporate sufficient safety measures in its design, such as redundancy, fire-containment, and anti-failure features.

NEC devices are classified into the following three quality grades:

"Standard", "Special", and "Specific". The Specific quality grade applies only to devices developed based on a customer designated "quality assurance program" for a specific application. The recommended applications of a device depend on its quality grade, as indicated below. Customers must check the quality grade of each device before using it in a particular application.

Standard: Computers, office equipment, communications equipment, test and measurement equipment, audio and visual equipment, home electronic appliances, machine tools, personal electronic equipment and industrial robots

Special: Transportation equipment (automobiles, trains, ships, etc.), traffic control systems, anti-disaster systems, anti-crime systems, safety equipment and medical equipment (not specifically designed for life support)

Specific: Aircrafts, aerospace equipment, submersible repeaters, nuclear reactor control systems, life support systems or medical equipment for life support, etc.

The quality grade of NEC devices is "Standard" unless otherwise specified in NEC's Data Sheets or Data Books. If customers intend to use NEC devices for applications other than those specified for Standard quality grade, they should contact an NEC sales representative in advance.

Anti-radioactive design is not implemented in this product.