

> Features

- High Current
- Low On-Resistance
- No Secondary Breakdown
- Low Driving Power
- High Forward Transconductance

> Applications

- Motor Control
- General Purpose Power Amplifier
- DC-DC converters

> Outline Drawing

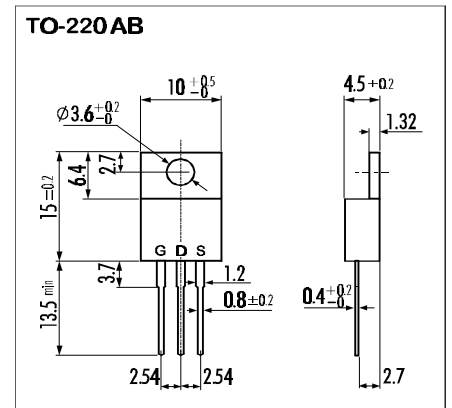

> Maximum Ratings and Characteristics

- Absolute Maximum Ratings (T_C=25°C), unless otherwise specified

Item	Symbol	Rating	Unit
Drain-Source-Voltage	V _{DS}	60	V
Drain-Gate-Voltage (R _{GS} =20KΩ)	V _{DGR}	60	V
Continous Drain Current	I _D	50	A
Pulsed Drain Current	I _{D(puls)}	200	A
Gate-Source-Voltage	V _{GS}	±20	V
Max. Power Dissipation	P _D	80	W
Operating and Storage Temperature Range	T _{ch}	150	°C
	T _{stg}	-55 ~ +150	°C

> Equivalent Circuit

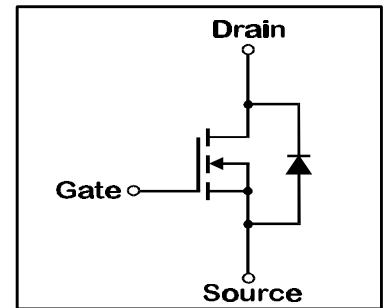

- Electrical Characteristics (T_C=25°C), unless otherwise specified

Item	Symbol	Test conditions	Min.	Typ.	Max.	Unit
Drain-Source Breakdown-Voltage	V _{(BR)DSS}	I _D =1mA V _{GS} =0V	60			V
Gate Threshold Voltage	V _{GS(th)}	I _D =1mA V _{DS} =V _{GS}	1,0	1,5	2,5	V
Zero Gate Voltage Drain Current	I _{DSS}	V _{DS} =60V T _{ch} =25°C		10	500	μA
		V _{GS} =0V T _{ch} =125°C		0,2	1,0	mA
Gate Source Leakage Current	I _{GSS}	V _{GS} =±20V V _{DS} =0V		10	100	nA
Drain Source On-State Resistance	R _{DS(on)}	I _D =25A V _{GS} =4V		0,022	0,04	Ω
		I _D =25A V _{GS} =10V		0,015	0,025	Ω
Forward Transconductance	g _{fs}	I _D =25A V _{DS} =25V	20	36		S
Input Capacitance	C _{iss}	V _{DS} =25V		2600	3900	pF
Output Capacitance	C _{oss}	V _{GS} =0V		800	1200	pF
Reverse Transfer Capacitance	C _{rss}	f=1MHz		400	600	pF
Turn-On-Time t _{on} (t _{on} =t _{d(on)} +t _r)	t _{d(on)}	V _{CC} =30V I _D =50A		20	30	ns
			t _r		130	200
Turn-Off-Time t _{off} (t _{off} =t _{d(off)} +t _f)	t _{d(off)}	V _{GS} =10V R _{GS} =25 Ω		400	600	ns
			t _f		170	250
Continous Reverse Drain Current	I _{DR}				50	A
Pulsed Reverse Drain Current	I _{DRM}				200	A
Diode Forward On-Voltage	V _{SD}	I _F =2xI _{DR} V _{GS} =0V T _{ch} =25°C		1,35	2,0	V
Reverse Recovery Time	t _{rr}	I _F =I _{DR} V _{GS} =0V		100		ns
Reverse Recovery Charge	Q _{rr}	-di _F /dt=100A/μs T _{ch} =25°C		0,5		μC

- Thermal Characteristics

Item	Symbol	Test conditions	Min.	Typ.	Max.	Unit
Thermal Resistance	R _{th(ch-a)}	channel to air			75	°C/W
	R _{th(ch-c)}	channel to case			1,56	°C/W

N-channel MOS-FET

60V | 0,025Ω | 50A | 80W

2SK2049

F-III Series



> Characteristics

Typical Output Characteristics

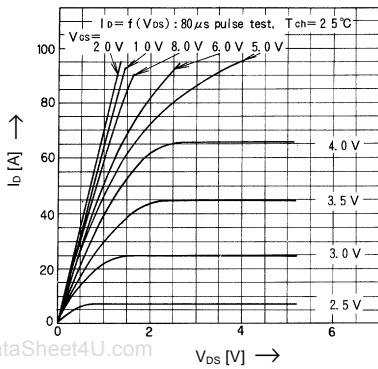

Drain-Source-On-State Resistance vs. T_{ch}

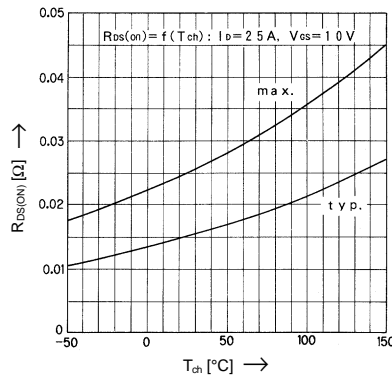

Typical Transfer Characteristics

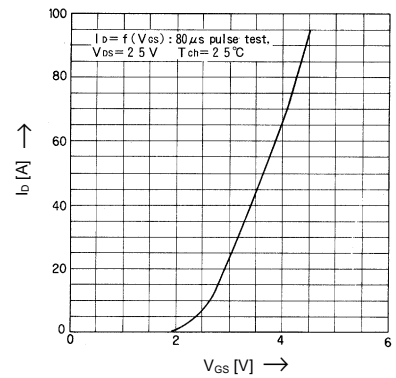

Typical Drain-Source-On-State-Resistance vs. I_D

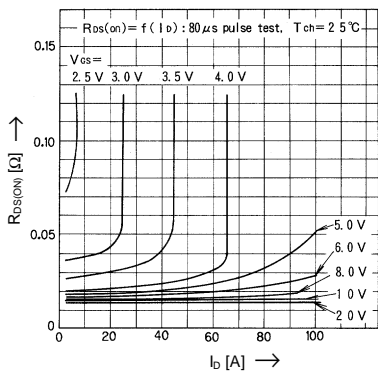

Typical Forward Transconductance vs. I_D

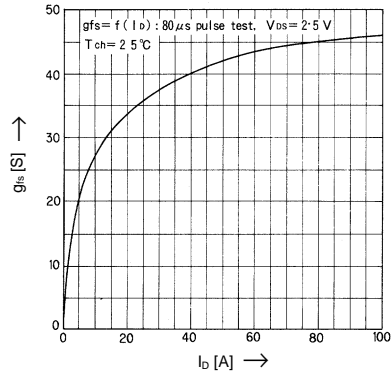

Gate Threshold Voltage vs. T_{ch}

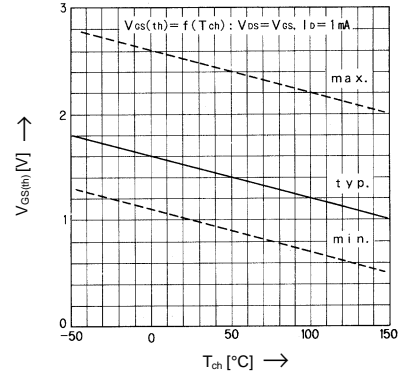

Typical Capacitance vs. V_{DS}

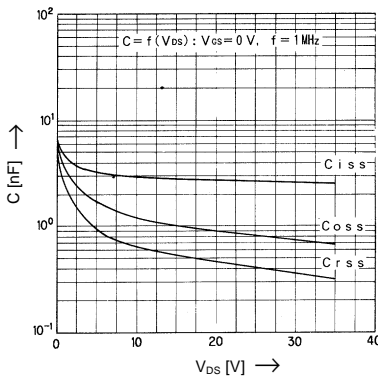

Typical Input Charge

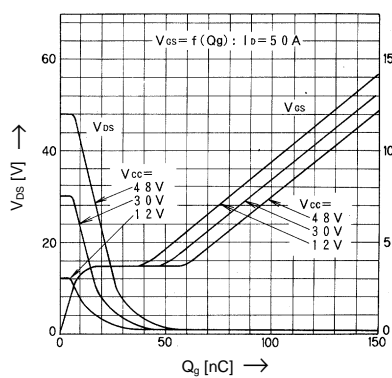

Forward Characteristics of Reverse Diode

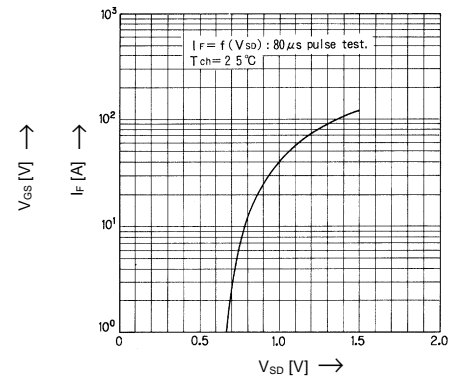

Allowable Power Dissipation vs. T_C

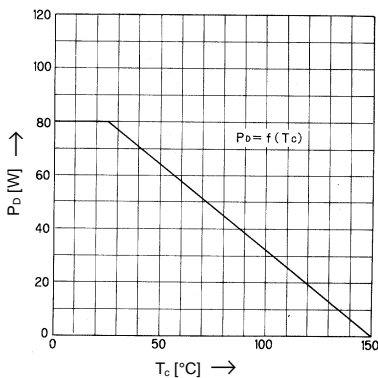

Safe operation area

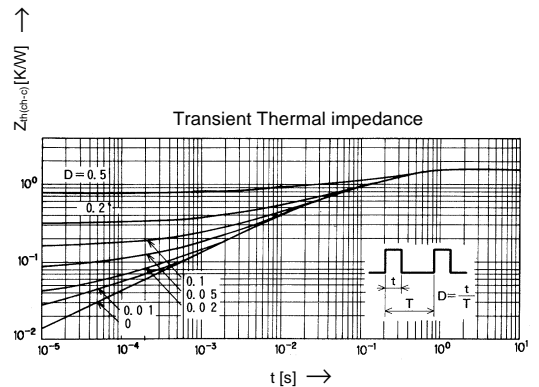
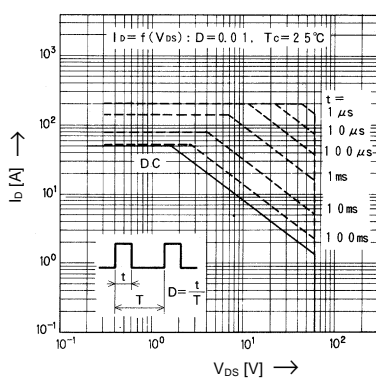

This specification is subject to change without notice!