

2SK2129

Silicon N-Channel Power F-MOS FET

■ Features

- Avalanche energy capacity guaranteed: EAS > 20mJ
- $V_{GSS} = \pm 30V$ guaranteed
- High-speed switching: $t_f = 50ns$
- No secondary breakdown

■ Applications

- Contactless relay
- Diving circuit for a solenoid
- Driving circuit for a motor
- Control equipment
- Switching power supply

■ Absolute Maximum Ratings ($T_C = 25^\circ C$)

Parameter	Symbol	Ratings	Unit	
Drain to Source breakdown voltage	V_{DSS}	800	V	
Gate to Source voltage	V_{GSS}	± 30	V	
Drain current	DC	I_D	± 3	A
	Pulse	I_{DP}	± 6	A
Avalanche energy capacity	EAS*	20	mJ	
Allowable power dissipation	$T_C = 25^\circ C$	P_D	50	W
	$T_a = 25^\circ C$		2	
Channel temperature	T_{ch}	150	$^\circ C$	
Storage temperature	T_{stg}	-55 to +150	$^\circ C$	

* $L = 4.5mH$, $I_L = 3A$, $V_{DD} = 50V$, 1 pulse

■ Electrical Characteristics ($T_C = 25^\circ C$)

Parameter	Symbol	Conditions	min	typ	max	Unit	
Drain to Source cut-off current	I_{DSS}	$V_{DS} = 640V$, $V_{GS} = 0$			0.1	mA	
Gate to Source leakage current	I_{GSS}	$V_{GS} = \pm 30V$, $V_{DS} = 0$			± 1	μA	
Drain to Source breakdown voltage	V_{DSS}	$I_D = 1mA$, $V_{GS} = 0$	800			V	
Gate threshold voltage	V_{th}	$V_{DS} = 25V$, $I_D = 1mA$	2		5	V	
Drain to Source ON-resistance	$R_{DS(on)}$	$V_{GS} = 10V$, $I_D = 2A$		3.2	4	Ω	
Forward transfer admittance	$ Y_{fs} $	$V_{DS} = 25V$, $I_D = 2A$	1.5	2.4		S	
Diode forward voltage	V_{DSF}	$I_{DR} = 3A$, $V_{GS} = 0$			-1.6	V	
Input capacitance (Common Source)	C_{iss}	$V_{DS} = 20V$, $V_{GS} = 0$, $f = 1MHz$		730		pF	
Output capacitance (Common Source)	C_{oss}				90		pF
Reverse transfer capacitance (Common Source)	C_{rss}				40		pF
Turn-on time (delay time)	$t_{d(on)}$	$V_{GS} = 10V$, $I_D = 2A$ $V_{DD} = 200V$, $R_L = 100\Omega$		35		ns	
Rise time	t_r				60		ns
Fall time	t_f				50		ns
Turn-off time (delay time)	$t_{d(off)}$				160		ns
Thermal resistance between channel and case	$R_{th(ch-c)}$				2.5	$^\circ C/W$	

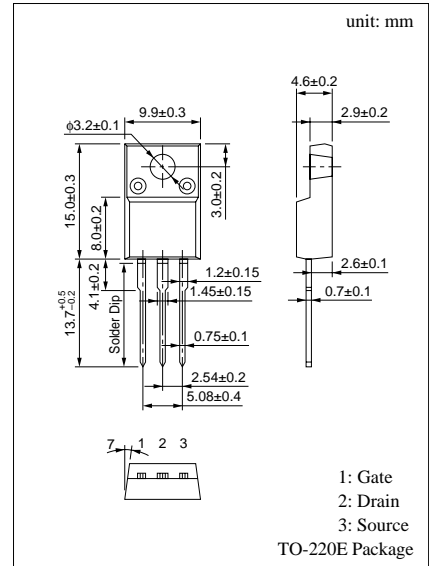

Area of safe operation (ASO)

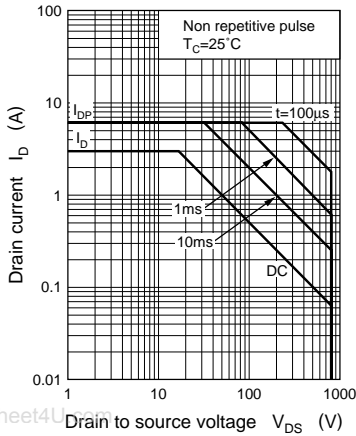

$P_D - T_a$

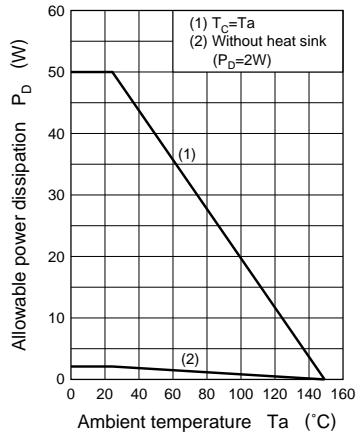

EAS — T_j

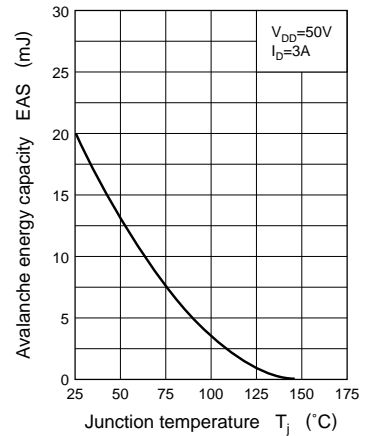

$I_D - V_{DS}$

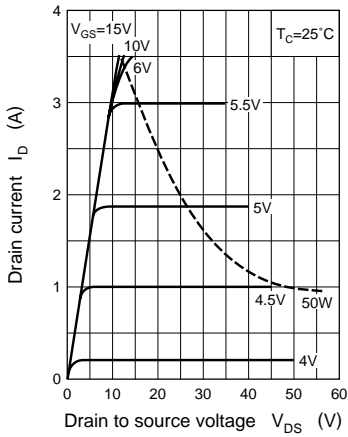

$I_D - V_{GS}$

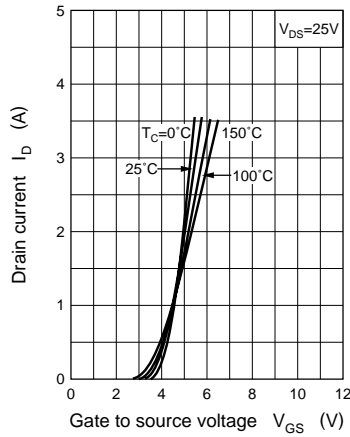

$V_{th} - T_C$

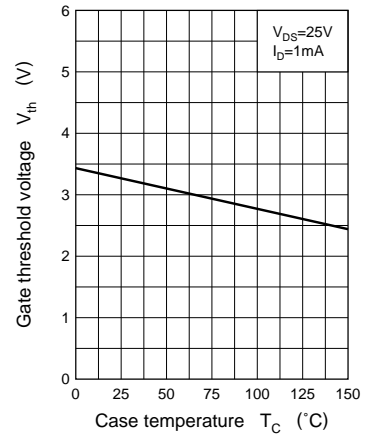

$V_{DS} - V_{GS}$

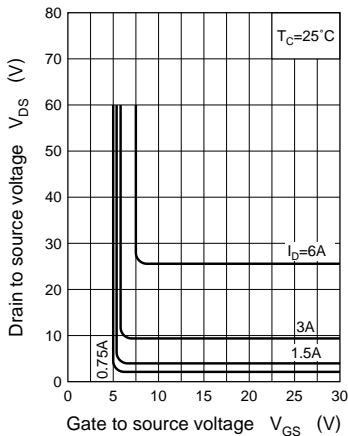

$R_{DS(on)} - I_D$

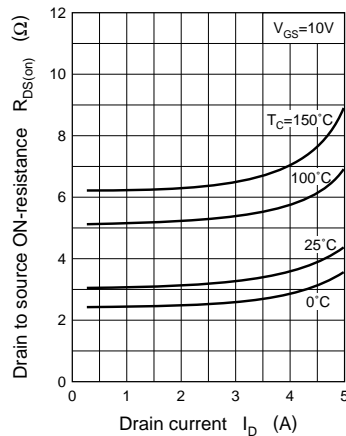

$|Y_{fs}| - I_D$

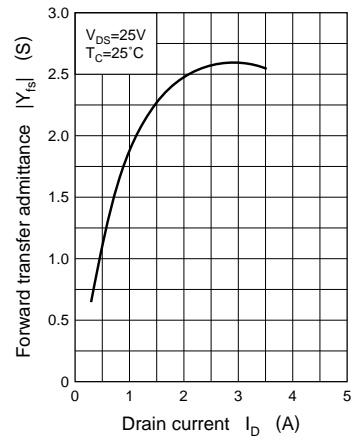

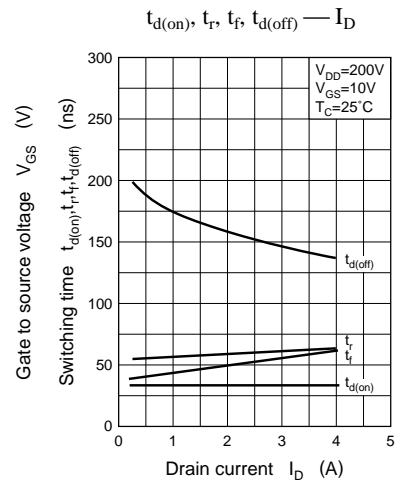
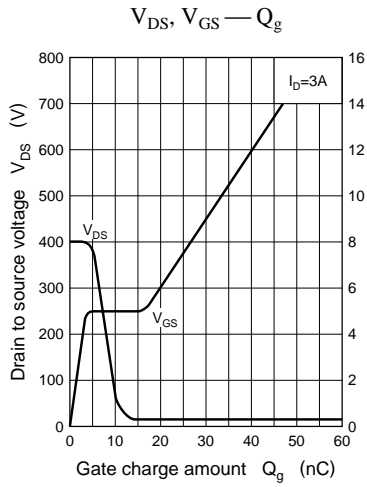
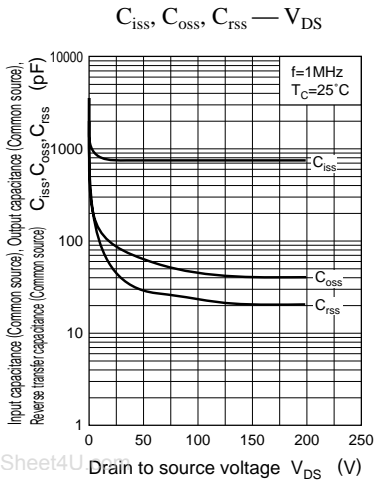

www.DataSheet4U.com