

> Features

- High Speed Switching
- Low On-Resistance
- No Secondary Breakdown
- Low Driving Power
- High Voltage
- $V_{GS} = \pm 30V$  Guarantee
- Repetitive Avalanche Rated

> Applications

- Switching Regulators
- UPS
- DC-DC converters
- General Purpose Power Amplifier

> Outline Drawing

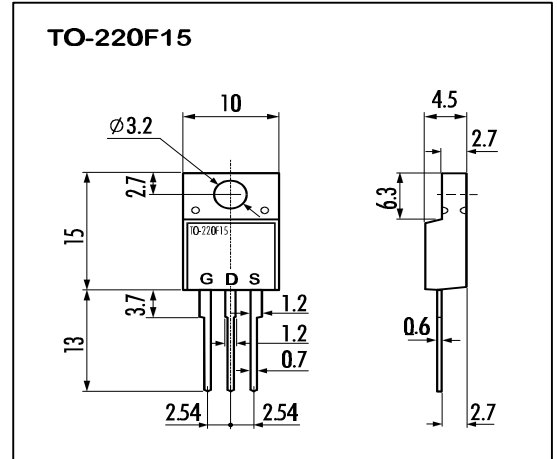

> Maximum Ratings and Characteristics

- Absolute Maximum Ratings ( $T_C=25^\circ C$ ), unless otherwise specified

Item	Symbol	Rating	Unit
Drain-Source-Voltage	$V_{DS}$	450	V
Continuous Drain Current	$I_D$	±8	A
Pulsed Drain Current	$I_{D(puls)}$	±32	A
Gate-Source-Voltage	$V_{GS}$	±35	V
Repetitive or Non-Repetitive ( $T_{ch} \leq 150^\circ C$ )	$I_{AR}$	8	A
Avalanche Energy	$E_{AS}$	164.1	mJ
Max. Power Dissipation	$P_D$	30	W
Operating and Storage Temperature Range	$T_{ch}$	150	$^\circ C$
	$T_{stg}$	-55 ~ +150	$^\circ C$

$L=4.70mH, V_{CC}=45V$

> Equivalent Circuit

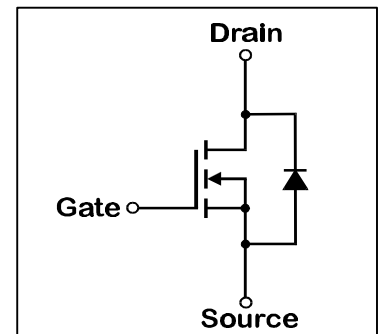

- Electrical Characteristics ( $T_C=25^\circ C$ ), unless otherwise specified

Item	Symbol	Test conditions	Min.	Typ.	Max.	Unit
Drain-Source Breakdown-Voltage	$BV_{DSS}$	$I_D=1mA, V_{GS}=0V$	450			V
Gate Threshold Voltage	$V_{GS(th)}$	$I_D=1mA, V_{DS}=V_{GS}$	3,5	4,0	4,5	V
Zero Gate Voltage Drain Current	$I_{DSS}$	$V_{DS}=450V, T_{ch}=25^\circ C$		10	500	$\mu A$
		$V_{GS}=0V, T_{ch}=125^\circ C$		0,2	1,0	mA
Gate Source Leakage Current	$I_{GSS}$	$V_{GS}=\pm 35V, V_{DS}=0V$		10	100	nA
Drain Source On-State Resistance	$R_{DS(on)}$	$I_D=4A, V_{GS}=10V$		1,0	1,2	$\Omega$
Forward Transconductance	$g_{fs}$	$I_D=4A, V_{DS}=25V$	2	4		S
Input Capacitance	$C_{iss}$	$V_{DS}=25V$		540	810	pF
Output Capacitance	$C_{oss}$	$V_{GS}=0V$		100	150	pF
Reverse Transfer Capacitance	$C_{rss}$	$f=1MHz$		45	70	pF
Turn-On-Time $t_{on} (t_{on}=t_{d(on)}+t_r)$	$t_{d(on)}$	$V_{CC}=300V, I_D=8A, V_{GS}=10V, R_{GS}=10\Omega$		13	20	ns
			$t_r$		40	60
Turn-Off-Time $t_{off} (t_{off}=t_{d(off)}+t_f)$	$t_{d(off)}$	$V_{GS}=10V, R_{GS}=10\Omega$		45	70	ns
			$t_f$		25	40
Avalanche Capability	$I_{AV}$	$L = 4,70mH, T_{ch}=25^\circ C$	8			A
Diode Forward On-Voltage	$V_{SD}$	$I_F=2I_{DR}, V_{GS}=0V, T_{ch}=25^\circ C$		1,1	1,65	V
Reverse Recovery Time	$t_{rr}$	$I_F=I_{DR}, V_{GS}=0V$		450		ns
Reverse Recovery Charge	$Q_{rr}$	$-di_F/dt=100A/\mu s, T_{ch}=25^\circ C$		3,7		$\mu C$

- Thermal Characteristics

Item	Symbol	Test conditions	Min.	Typ.	Max.	Unit
Thermal Resistance	$R_{th(ch-c)}$	channel to case			4,17	$^\circ C/W$
	$R_{th(ch-a)}$	channel to air			62,5	$^\circ C/W$

N-channel MOS-FET			
450V	1,2Ω	±8A	30W

# 2SK2872-01MR

## FAP-IIS Series



### > Characteristics

Typical Output Characteristics

$I_D = f(V_{DS})$ ; 80μs pulse test;  $T_C = 25^\circ\text{C}$

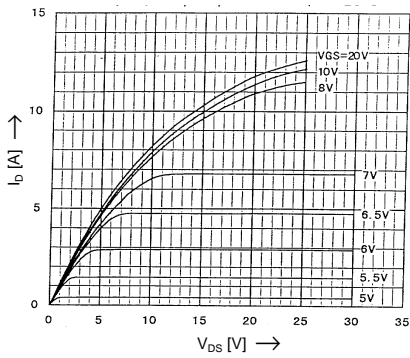

Drain-Source-On-State Resistance vs.  $T_{ch}$

$R_{DS(on)} = f(T_{ch})$ ;  $I_D = 4\text{A}$ ;  $V_{GS} = 10\text{V}$

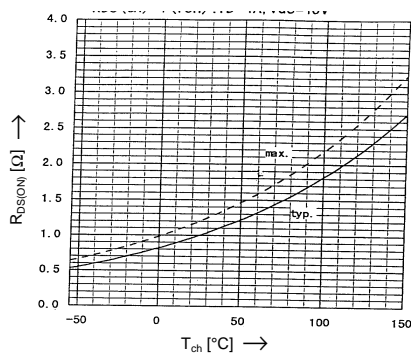

Typical Transfer Characteristics

$I_D = f(V_{GS})$ ; 80μs pulse test;  $V_{DS} = 25\text{V}$ ;  $T_C = 25^\circ\text{C}$

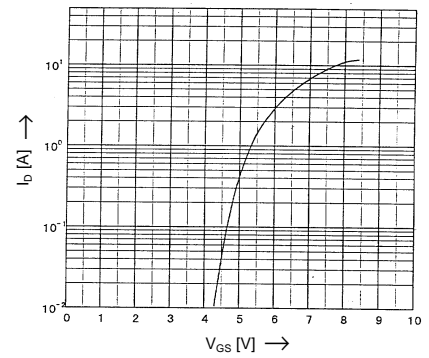

Typical Drain-Source-On-State-Resistance vs.  $I_D$

$R_{DS(on)} = f(I_D)$ ; 80μs pulse test;  $T_C = 25^\circ\text{C}$

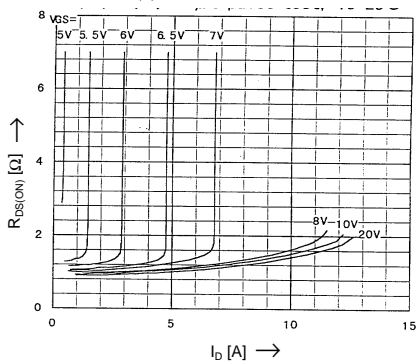

Typical Forward Transconductance vs.  $I_D$

$g_{fs} = f(I_D)$ ; 80μs pulse test;  $V_{DS} = 25\text{V}$ ;  $T_C = 25^\circ\text{C}$

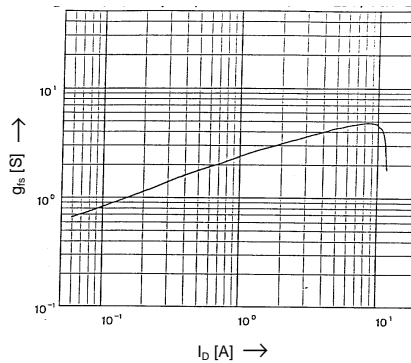

Gate Threshold Voltage vs.  $T_{ch}$

$V_{GS(th)} = f(T_{ch})$ ;  $I_D = 1\text{mA}$ ;  $V_{DS} = V_{GS}$

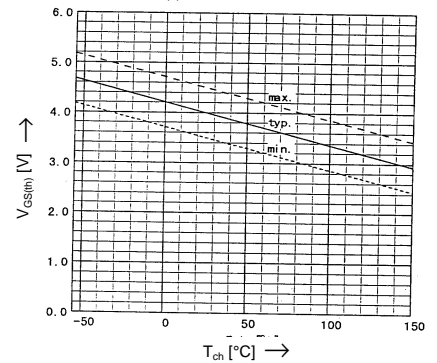

Typical Capacitances vs.  $V_{DS}$

$C = f(V_{DS})$ ;  $V_{GS} = 0\text{V}$ ;  $f = 1\text{MHz}$

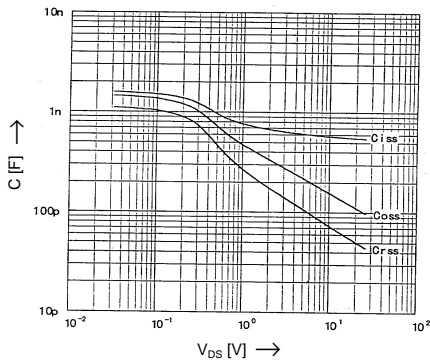

Typical Gate Charge Characteristic

$V_{GS} = f(Q_g)$ ;  $I_D = 8\text{A}$ ;  $T_C = 25^\circ\text{C}$

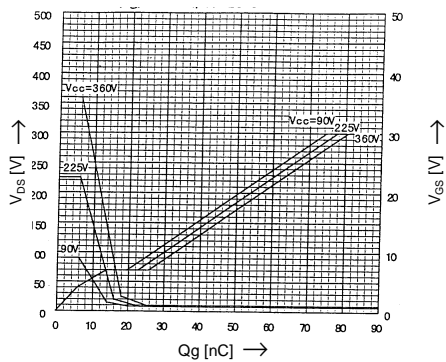

Forward Characteristics of Reverse Diode

$I_F = f(V_{SD})$ ; 80μs pulse test;  $V_{GS} = 0\text{V}$

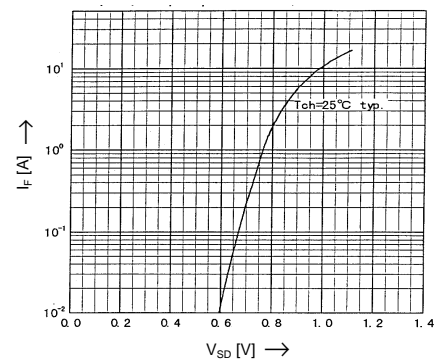

Avalanche Energy Derating

$E_{as} = f(\text{starting } T_{ch})$ ;  $V_{CC} = 45\text{V}$ ;  $I_{AV} = 8\text{A}$

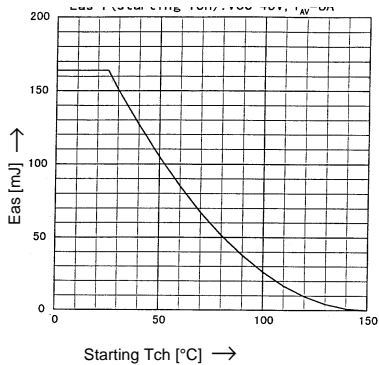

Safe operation area

$I_D = f(V_{DS})$ ;  $D = 0.01$ ;  $T_C = 25^\circ\text{C}$

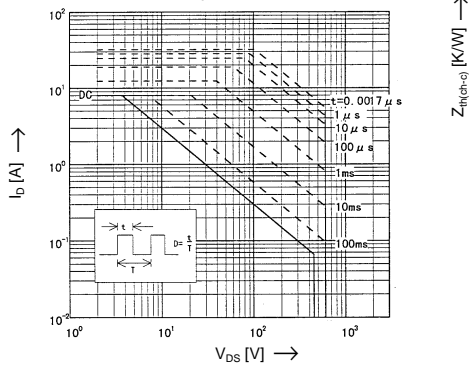

Transient Thermal impedance

$Z_{th(ch-c)} = f(t)$  parameter:  $D = I/T$

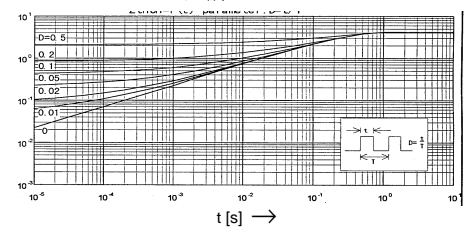

This specification is subject to change without notice!

N-channel MOS-FET			
450V	1,2Ω	±8A	30W

# 2SK2872-01MR

## FAP-IIS Series



### > Characteristics

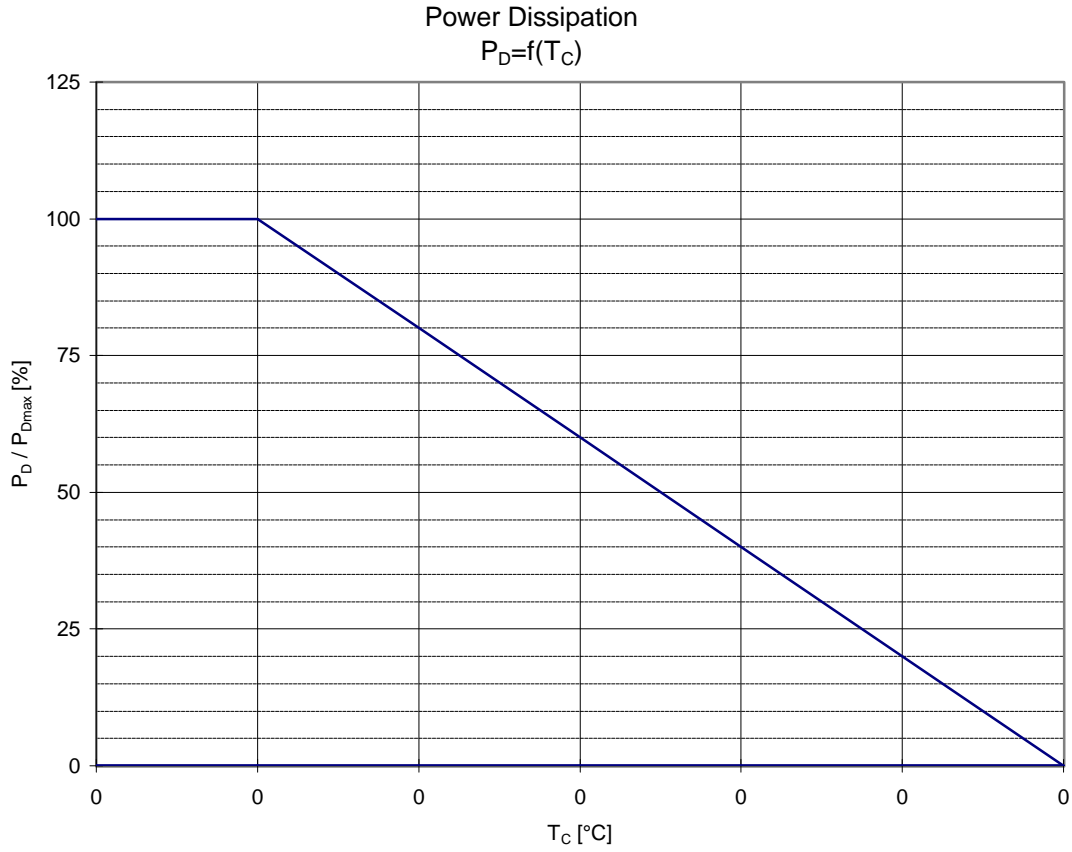

This specification is subject to change without notice!