

MITSUBISHI RF POWER MOS FET  
**2SK2973**

**DESCRIPTION**

2SK2973 is a MOS FET type transistor specifically designed for VHF/UHF power amplifiers applications.

**FEATURES**

- High power gain:G<sub>pe</sub> 13dB  
 @V<sub>DD</sub>=9.6V,f=450MHz,P<sub>in</sub>=17dBm
- High efficiency:55% typ.
- Source case type SOT-89 package  
 (connected internally to source)

**APPLICATION**

For drive stage and output stage of power amplifiers in VHF/UHF band portable radio sets.

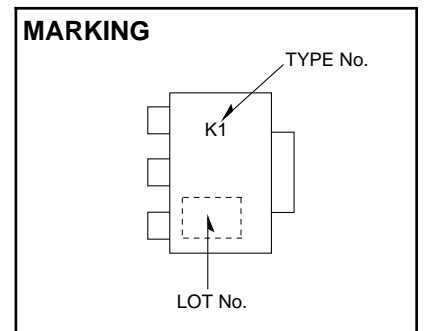
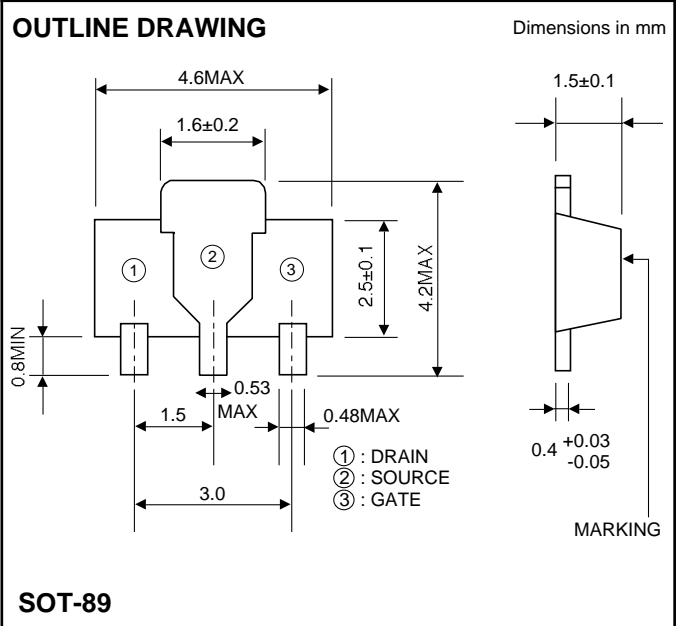

**ABSOLUTE MAXIMUM RATINGS** (T<sub>c</sub>=25°C, unless otherwise noted)

Symbol	Parameter	Conditions	Ratings	Unit
V <sub>DSS</sub>	Drain to source voltage		17	V
V <sub>GSS</sub>	Gate to source voltage		±10	V
P <sub>ch</sub>	Channel dissipation	T <sub>c</sub> =25°C (Note2)	1.5	W
T <sub>j</sub>	Junction temperature		150	°C
T <sub>stg</sub>	Storage temperature		-40 to +110	°C

Note1: Above parameters are guaranteed independently.  
 2: Solder on printed board(Copper leaf area;70×70mm,t=1.6mm Epoxy glass)

**ELECTRICAL CHARACTERISTICS** (T<sub>c</sub>=25°C, unless otherwise noted)

Symbol	Parameter	Test conditions	Limits			Unit
			Min	Typ	Max	
I <sub>DSS</sub>		V <sub>DS</sub> =12V, V <sub>GS</sub> =0V	—	—	10	μA
I <sub>GSS</sub>		V <sub>GS</sub> =10V, V <sub>DS</sub> =0V	—	—	1	μA
V <sub>TH</sub>	Threshold voltage	V <sub>DS</sub> =7V, I <sub>DS</sub> =1mA	1.2		1.8	V
C <sub>iss</sub>		V <sub>GS</sub> =10V, V <sub>DS</sub> =0V,f=1MHz		10		pF
C <sub>oss</sub>		V <sub>DS</sub> =10V, V <sub>GS</sub> =0V,f=1MHz		8		pF
P <sub>out</sub>		V <sub>DS</sub> =9.6V, P <sub>in</sub> =50mW,f=450MHz	1	1.2		W
h <sub>d</sub>			45	55		%

Note: Above parameters,ratings,limits and conditions are subject to change.

TYPICAL PERFORMANCE DATA

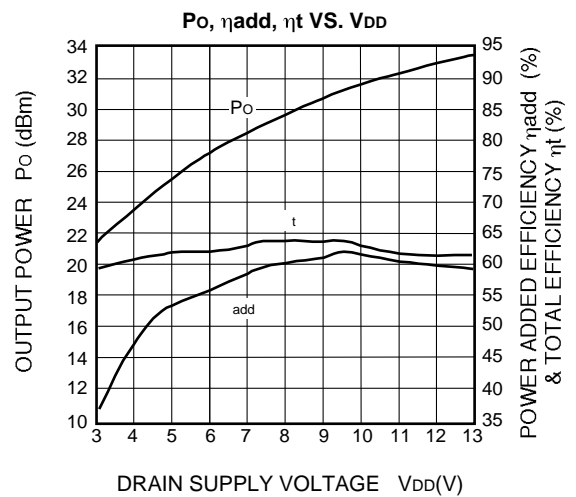
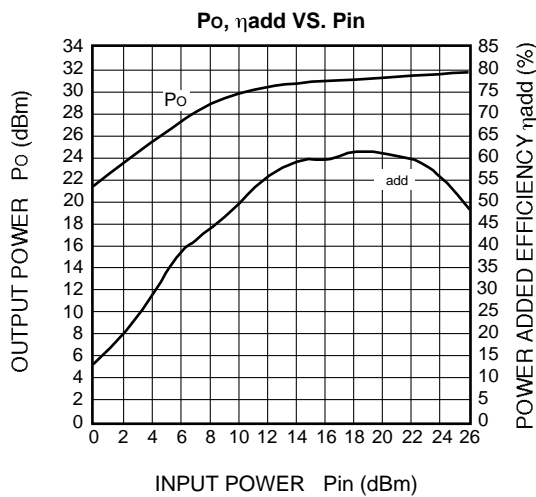
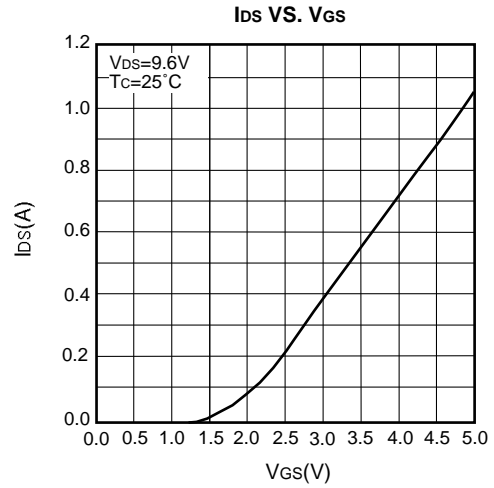
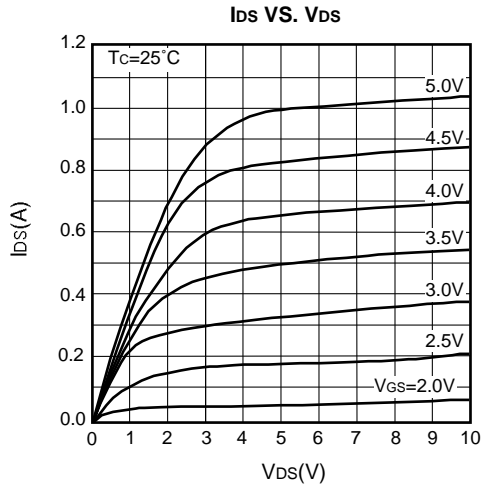

EQUIVALENT CIRCUIT

@  $V_{DD}=9.6\text{V}$  Match

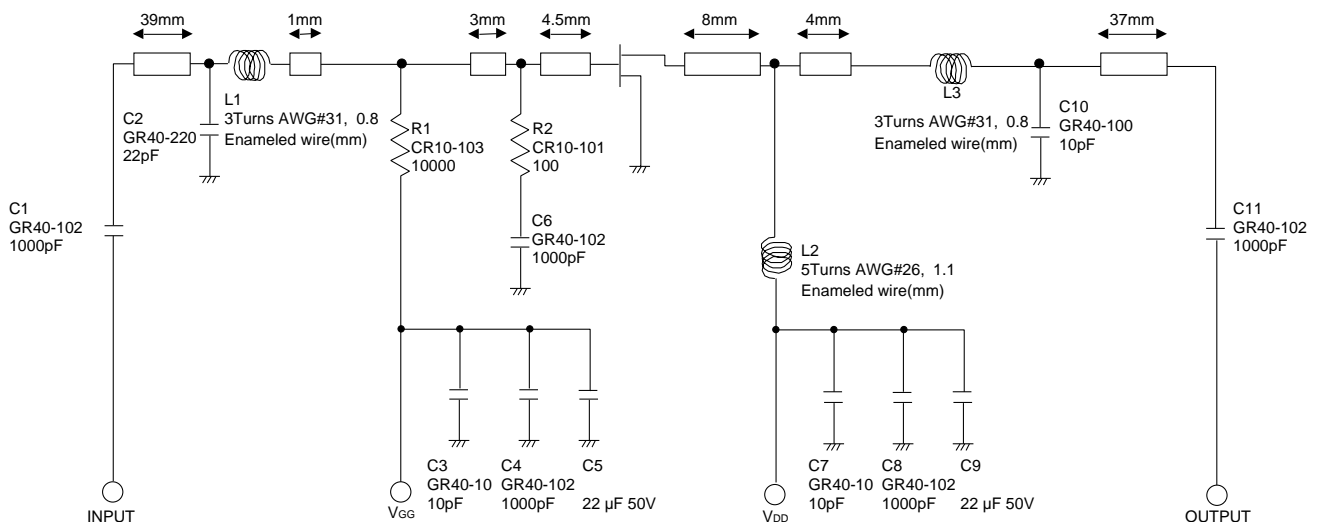

Note: Board material-glass epoxy substrate  
micro strip line width=1mm,  $r : 4.8, t : 0.6\text{mm}$

S-PARAMETER DATA(TYPICAL)

V<sub>DD</sub>=7V, I<sub>D</sub>=100mA

FREQ. (MHz)	S <sub>11</sub>		S <sub>12</sub>		S <sub>21</sub>		S <sub>22</sub>	
	Real	Imag	Real	Imag	Real	Imag	Real	Imag
50	0.962	-30.909	0.019	70.131	15.173	155.450	0.517	-33.518
100	0.877	-57.078	0.030	55.726	13.006	134.869	0.497	-60.987
150	0.797	-76.635	0.036	44.160	10.709	119.517	0.482	-80.439
200	0.741	-91.748	0.038	40.231	8.877	107.569	0.475	-94.398
250	0.711	-103.034	0.038	38.866	7.448	97.989	0.478	-103.912
300	0.691	-111.898	0.036	41.687	6.331	90.515	0.482	-111.111
350	0.683	-119.086	0.036	45.980	5.489	83.918	0.490	-117.019
400	0.680	-125.145	0.036	54.414	4.833	78.172	0.504	-121.733
450	0.680	-130.461	0.038	62.799	4.299	73.186	0.515	-125.706
500	0.684	-135.027	0.041	70.422	3.863	68.210	0.528	-129.494
550	0.689	-139.643	0.047	77.349	3.488	63.808	0.538	-132.827
600	0.695	-143.458	0.054	81.691	3.180	59.700	0.550	-136.175
650	0.704	-147.473	0.062	85.975	2.937	55.733	0.563	-139.265
700	0.710	-151.333	0.072	88.284	2.710	51.615	0.575	-142.636
750	0.719	-154.997	0.082	89.530	2.509	48.016	0.587	-145.786
800	0.725	-158.593	0.094	89.900	2.346	44.142	0.599	-149.500
850	0.736	-162.473	0.106	89.449	2.190	40.196	0.607	-152.741
900	0.739	-166.136	0.118	88.195	2.032	36.568	0.614	-156.200
950	0.751	-169.642	0.131	86.908	1.910	32.944	0.628	-159.932
1000	0.759	-173.163	0.145	85.477	1.767	29.492	0.632	-163.560
1050	0.763	-176.805	0.158	83.221	1.663	26.400	0.640	-167.393
1100	0.772	-179.819	0.170	81.026	1.561	23.026	0.648	-171.167
1150	0.777	-176.141	0.183	78.964	1.448	19.886	0.654	-174.329
1200	0.788	-172.631	0.195	76.775	1.351	17.290	0.656	-177.882
1250	0.793	-169.504	0.207	74.515	1.263	14.209	0.659	-178.966
1300	0.797	-165.990	0.220	72.443	1.168	12.331	0.655	-176.140
1350	0.804	-162.470	0.230	69.906	1.082	10.481	0.651	-173.319
1400	0.809	-159.531	0.240	67.648	1.008	9.729	0.658	-171.233
1450	0.816	-156.335	0.251	65.743	0.953	9.000	0.661	-169.940
1500	0.825	-153.305	0.259	63.341	0.902	8.358	0.668	-168.226

V<sub>DD</sub>=13V, I<sub>D</sub>=100mA

FREQ. (MHz)	S <sub>11</sub>		S <sub>12</sub>		S <sub>21</sub>		S <sub>22</sub>	
	Real	Imag	Real	Imag	Real	Imag	Real	Imag
50	0.969	-28.167	0.014	71.719	15.673	157.229	0.584	-25.160
100	0.895	-52.309	0.023	58.790	13.660	137.611	0.550	-46.574
150	0.818	-71.057	0.028	50.602	11.486	122.578	0.519	-62.601
200	0.766	-85.910	0.030	46.574	9.627	110.613	0.498	-75.182
250	0.731	-97.535	0.030	45.714	8.179	101.187	0.490	-84.524
300	0.713	-106.770	0.030	48.027	7.015	93.440	0.487	-91.913
350	0.699	-114.312	0.028	55.670	6.113	86.760	0.491	-98.343
400	0.691	-120.895	0.031	62.737	5.388	80.878	0.500	-103.694
450	0.694	-126.479	0.032	73.404	4.823	75.886	0.508	-107.961
500	0.692	-131.266	0.037	80.763	4.335	70.903	0.519	-112.507
550	0.694	-136.032	0.043	87.314	3.935	66.204	0.529	-116.209
600	0.698	-140.107	0.050	92.097	3.611	62.009	0.539	-120.031
650	0.705	-144.290	0.059	95.477	3.331	58.175	0.551	-123.436
700	0.711	-148.279	0.069	96.935	3.095	53.864	0.564	-126.986
750	0.714	-151.821	0.079	98.151	2.875	49.913	0.575	-130.446
800	0.719	-155.417	0.091	97.664	2.685	46.260	0.585	-134.470
850	0.731	-159.212	0.102	96.976	2.511	42.090	0.595	-137.974
900	0.735	-162.934	0.116	95.996	2.342	38.080	0.605	-141.841
950	0.745	-166.562	0.128	94.383	2.215	34.580	0.619	-145.830
1000	0.750	-170.178	0.142	92.828	2.064	30.750	0.623	-149.638
1050	0.757	-173.594	0.155	90.415	1.936	27.264	0.632	-153.862
1100	0.769	-177.132	0.168	87.874	1.817	23.902	0.642	-158.231
1150	0.775	-179.157	0.182	85.838	1.693	20.361	0.650	-161.799
1200	0.782	-175.539	0.195	82.989	1.585	17.461	0.653	-165.820
1250	0.793	-172.187	0.208	80.799	1.476	14.114	0.657	-169.544
1300	0.799	-169.041	0.221	78.268	1.360	11.831	0.656	-172.628
1350	0.807	-165.082	0.233	75.458	1.263	9.495	0.651	-176.074
1400	0.814	-162.211	0.243	72.924	1.163	8.102	0.659	-178.678
1450	0.816	-158.932	0.255	71.005	1.097	7.206	0.660	-179.809
1500	0.829	-155.796	0.264	68.509	1.039	6.401	0.668	-177.692