

K301 • K302 • K304

These Photocouplers consist of a Gallium Arsenide Infrared Emitting Diode and a Silicon NPN Photo Darlington transistor per a channel.

The K301 has one channel in a 4-pin mini-flat SMD package.

The K302 has two channels in a 8-pin mini-flat SMD package.

The K304 has four channels in a 16-pin mini-flat SMD package.

FEATURES

- Mini-flat Package
- Collector-Emitter Voltage : Min.30V
- Current Transfer Ratio : Type 600% (at $I_F=1mA$, $V_{CE}=2V$)
- Electrical Isolation Voltage : AC3750V_{rms}

APPLICATIONS

- Interface between two circuits of different potential
- Telephone Line Receiver
- Automatic Vending Machine
- Power Supply Regulators

DIMENSION

(Unit : mm)

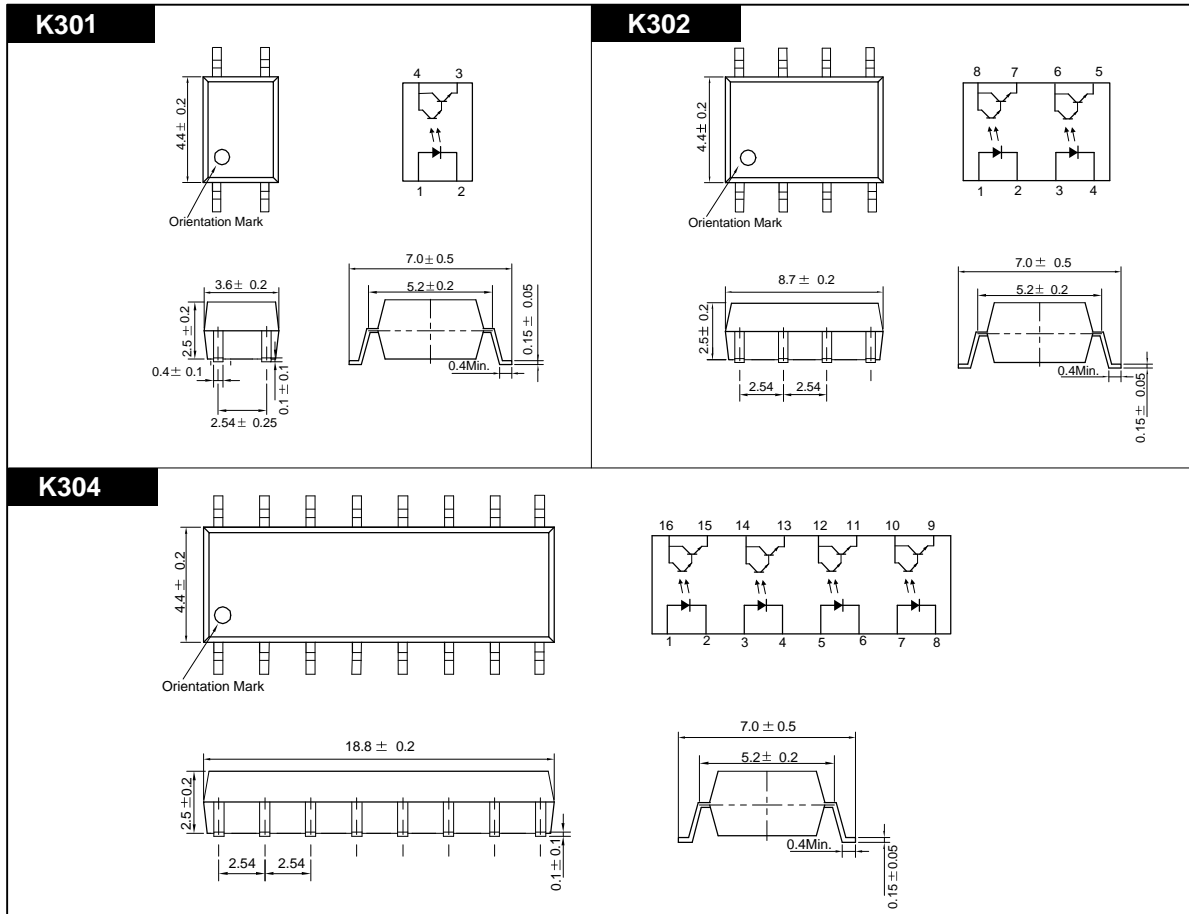

K301 • K302 • K304

MAXIMUM RATINGS

(Ta=25)

Parameter		Symbol	Rating	Unit
Input	Forward Current	IF	50	mA
	Reverse Voltage	VR	5	V
	Peak Forward Current ^{*1}	IFP	1	A
	Power Dissipation	PD	70	mW
	Junction Temperature	TJ	125	
Output	Collector-Emitter Breakdown Voltage	BVCEO	30	V
	Emitter-Collector Breakdown Voltage	BVECO	5	V
	Collector Current	IC	50	mA
	Collector Power Dissipation	PC	150	mW
Input to Output Isolation Voltage ^{*2}		Viso	AC3750	Vrms
Storage Temperature		Tstg	-55~+125	
Operating Temperature		Topr	-30~+85	
Lead Soldering Temperature ^{*3}		Tsol	260	
Total Power Dissipation		Ptot	250	mW

*1. Input current with 100μs pulse width, 1% duty cycle

*2. Measured at RH=40~60% for 1min

*3. 1/16 inch form case for 10sec

ELECTRO-OPTICAL CHARACTERISTICS

(Ta=25 , unless otherwise noted)

Parameter		Symbol	Condition	Min.	Typ.	Max.	Unit.
Input	Forward Voltage	VF	IF=10mA	-	1.15	1.30	V
	Reverse Current	IR	VR=5V	-	-	10	μA
	Capacitance	CT	V=0, f=1KHz	-	30	-	pF
Output	Collector-Emitter Breakdown Voltage	BVCEO	IC=0.5mA	30	-	-	V
	Emitter-Collector Breakdown Voltage	BVECO	IE=0.1mA	5	-	-	V
	Collector Dark Current	ICEO	IF=0, VCE=10V	-	-	100	nA
	Capacitance	CCE	VCE=0, f=1KHz	-	10	-	pF
Coupled	Current Transfer Ratio ^{*4}	CTR	IF=1mA, VCE=2V	300	-	1500	%
	Collector-Emitter Saturation Voltage	VCE(SAT)	IF=1mA, IC=2mA	-	0.85	1.0	V
	Input-Output Capacitance	CIO	V=0, f=1KHz	-	5	-	pF
	Input-Output Isolation Resistance	RIO	RH=40~60%, V=500V	-	10 ¹¹	-	
	Rise Time	tr	VCE=10V, RL=100	-	100	-	μs
	Fall Time	tf	IC=10mA	-	100	-	μs

*4. CTR=(IC/IF) X 100 (%)

K301 • K302 • K304

Forward Current vs. Ambient Temperature

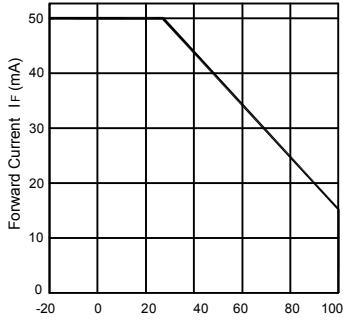

Collector Power Dissipation vs. Ambient Temperature

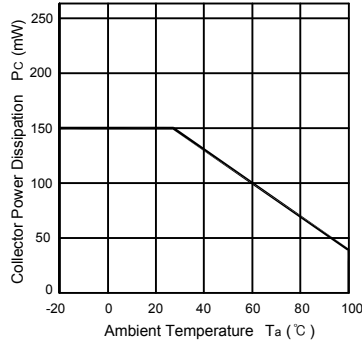

Forward Current vs. Forward Voltage

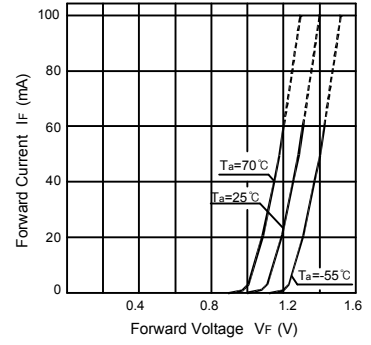

Collector Current vs. Collector-Emitter Voltage

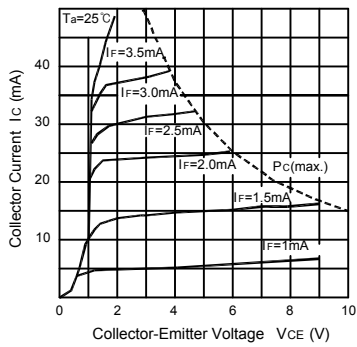

Dark Current vs. Ambient Temperature

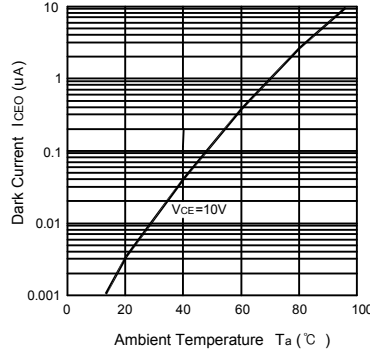

Collector Current vs. Forward Current

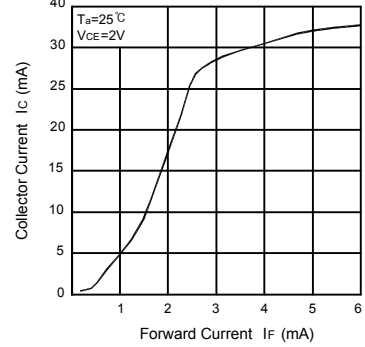

Response Time vs. Load Resistance

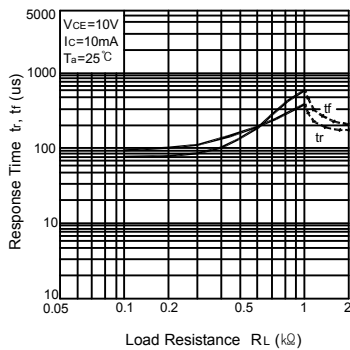

Switching Time Test Circuit

