

SPECIFICATION

Device Name : Power MOSFET

Type Name : 2SK3102-01R

Spec. No. : **MS5 F4207**

This material and the information herein is the property of Fuji Electric Co.,Ltd. They shall be neither reproduced, copied, lent, or disclosed in any way whatsoever for the use of any third party nor used for the manufacturing purposes without the express written consent of Fuji Electric Co.,Ltd.

Fuji Electric Co.,Ltd.
Matsumoto Factory

	DATE	NAME	APPROVED	
DRAWN	Feb.-13-'98	C. Ota		Fuji Electric Co.,Ltd.
CHECKED	Feb.-15-'98	<i>[Signature]</i>	<i>[Signature]</i>	
				DWG.NO. MS5 F4207 1/12

- 1.Scope** This specifies Fuji Power MOSFET 2SK3102-01R
- 2.Construction** N-Channel enhancement mode power MOSFET
- 3.Applications** for Switching
- 4.Outview** TO-3PF Outview See to 5/12 page

5.Absolute Maximum Ratings at Tc=25°C (unless otherwise specified)

Description	Symbol	Characteristics	Unit	Remarks
Drain-Source Voltage	V _{DS}	600	V	
Continuous Drain Current	I _D	±10	A	
Pulsed Drain Current	I _{DP}	±36	A	
Gate-Source Voltage	V _{GS}	±35	V	
Repetitive or non-repetitive	I _{AR}	10	A	T _{ch} ≤ 150°C
Avalanche energy	E _{AS}	433.7	mj	
Maximum Power Dissipation	P _D	80	W	
Operating and Storage	T _{ch}	150	°C	
Temperature range	T _{stg}	-55 to +150	°C	

*L=7.95mH, V_{cc}=60V

6.Electrical Characteristics at Tc=25°C (unless otherwise specified)

Static Ratings

Description	Symbol	Conditions	min.	typ.	max.	Unit
Drain-Source Breakdown Voltage	BV _{DSS}	I _D =1mA V _{GS} =0V	600			V
Gate Threshold Voltage	V _{GS(th)}	I _D =1mA V _{DS} =V _{GS}	3.5	4.0	4.5	V
Zero Gate Voltage Drain Current	I _{DSS}	V _{DS} =600V V _{GS} =0V		10	500	μA
		T _{ch} =25°C				
		T _{ch} =125°C		0.2	1.0	mA
Gate-Source Leakage Current	I _{GSS}	V _{GS} =±30V V _{DS} =0V		10	100	nA
Drain-Source On-State Resistance	R _{DS(on)}	I _D =5A V _{GS} =10V		0.85	1	Ω

This material and the information herein is the property of Fuji Electric Co.,Ltd. They shall be neither reproduced, copied, lent, or disclosed in any way whatsoever for the use of any third party nor used for the manufacturing purposes without the express written consent of Fuji Electric Co.,Ltd.

a

Dynamic Ratings

Description	Symbol	Conditions	min.	typ.	max.	Unit
Forward Transconductance	g_{fs}	$I_D=5A$ $V_{DS}=25V$	3.0	6.0		S
Input Capacitance	C_{iss}	$V_{DS}=25V$		1100	1700	pF
Output Capacitance	C_{oss}	$V_{GS}=0V$		170	260	
Reverse Transfer Capacitance	C_{rss}	$f=1MHz$		75	120	
Turn-On Time	$t_d(on)$	$V_{cc}=300V$		25	40	ns
	t_r	$V_{GS}=10V$		70	110	
Turn-Off Time	$t_d(off)$	$I_D=10A$		75	120	
	t_f	$R_{GS}=10\Omega$		40	60	

Reverse Diode

Description	Symbol	Conditions	min.	typ.	max.	Unit
Avalanche Capability	I_{AV}	$L=1.19mH$ $T_{ch}=25^\circ C$ See Fig.1 and Fig.2	10			A
Diode Forward On-Voltage	V_{SD}	$I_F=2 \times I_{DR}$ $V_{GS}=0V$ $T_{ch}=25^\circ C$		1.0	1.5	V
Reverse Recovery Time	t_{rr}	$I_F=I_{DR}$ $V_{GS}=0V$		500		ns
Reverse Recovery Charge	Q_{rr}	$-di/dt=100A/\mu s$ $T_{ch}=25^\circ C$		6.5		μC

7.Thermal Resistance

Description	Symbol	min.	typ.	max.	Unit
Channel to Case	$R_{th}(ch-c)$			1.56	$^\circ C/W$
Channel to Ambient	$R_{th}(ch-a)$			30.0	$^\circ C/W$

Fig.1 Test circuit

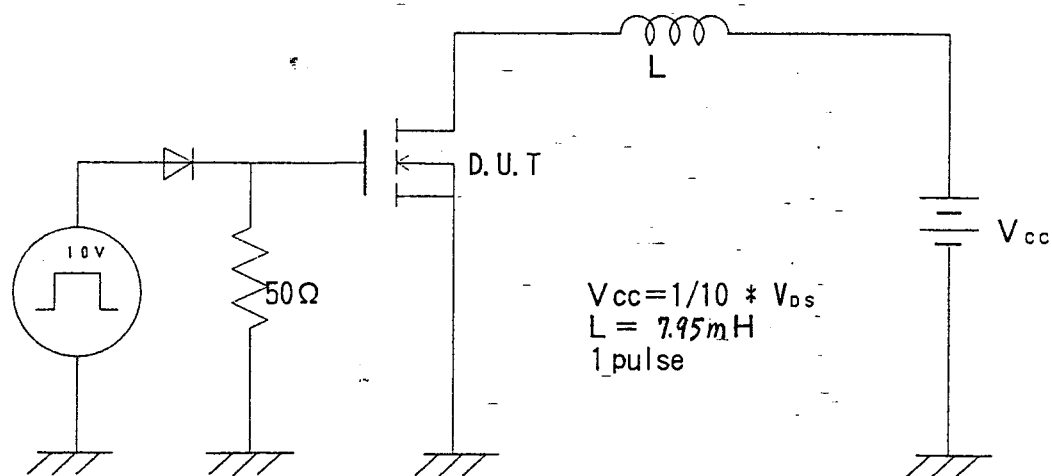
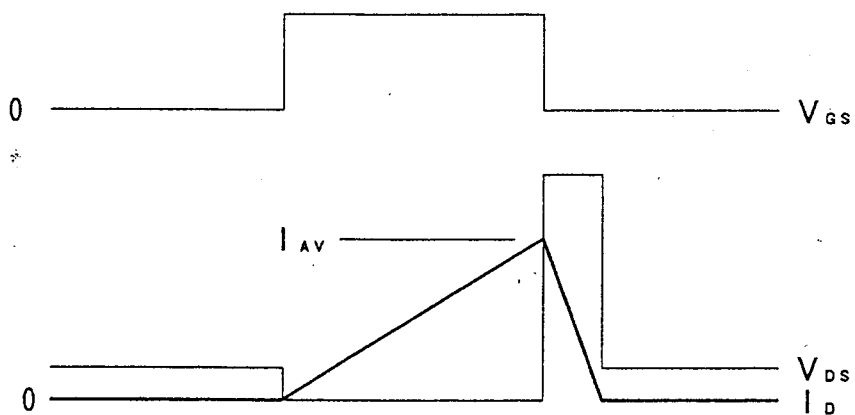
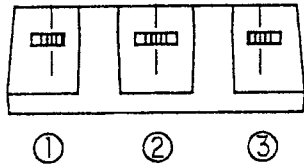
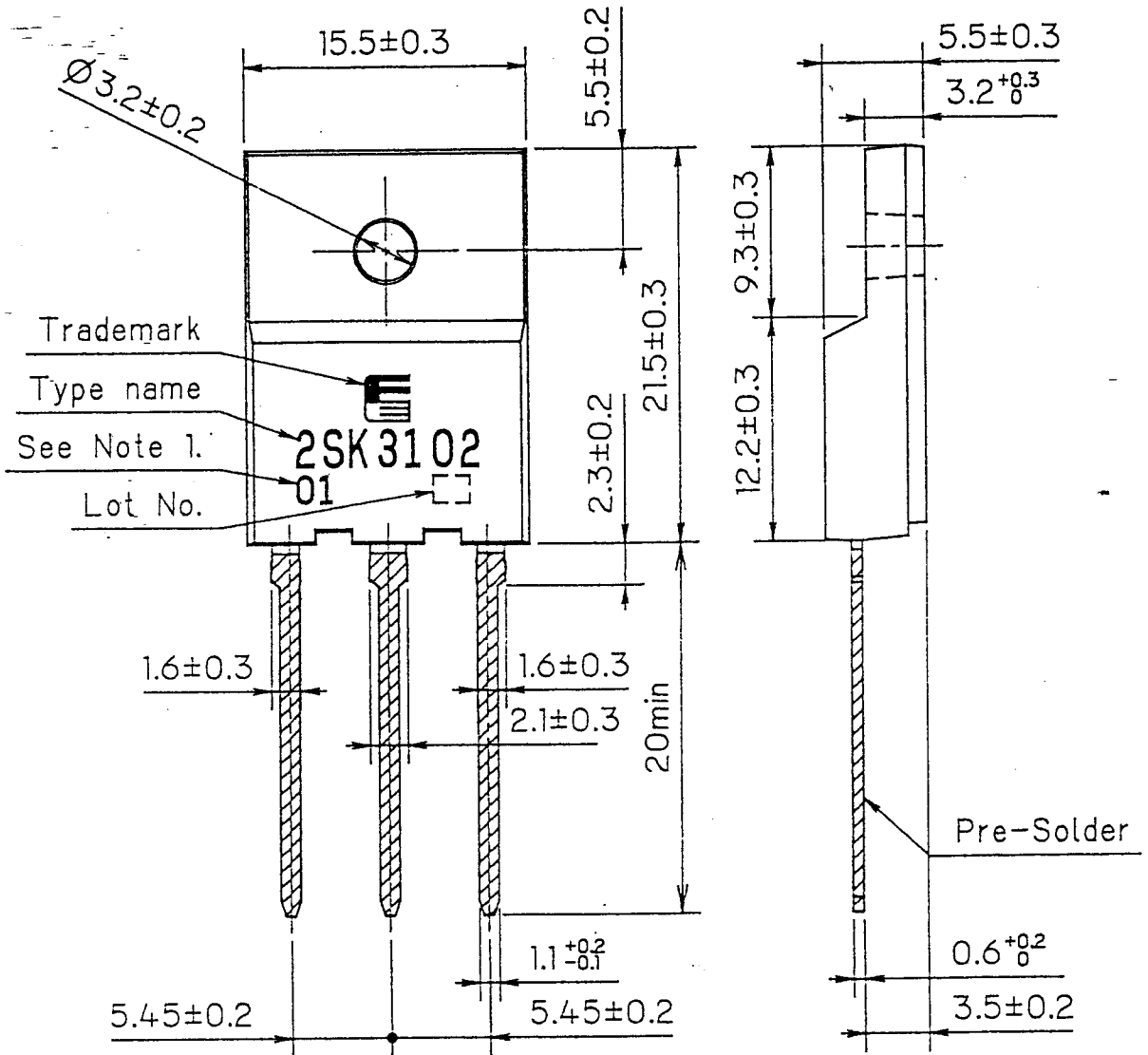

Fig.2 Operating waveforms



FUJI POWER MOSFET

TYPE : 2SK3102-01R



CONNECTION

Note 1. Guaranteed mark of avalanche ruggedness.

- ① GATE
- ② DRAIN
- ③ SOURCE

DIMENSIONS ARE IN MILLIMETERS.

Fuji Electric Co.,Ltd.

DWG.NO.

MS5 F4207

5/12

This material and the information herein is the property of Fuji Electric Co.,Ltd. They shall be neither reproduced, copied, lent, or disclosed in any way whatsoever for the use of any third party nor used for the manufacturing purposes without the express written consent of Fuji Electric Co.,Ltd.

This material and the information herein is the property of Fuji Electric Co., Ltd. They shall be neither reproduced, copied, lent, or disclosed in any way whatsoever for the use of any third party nor used for the manufacturing purposes without the express written consent of Fuji Electric Co., Ltd.

Power Dissipation
 $PD=f(T_c)$

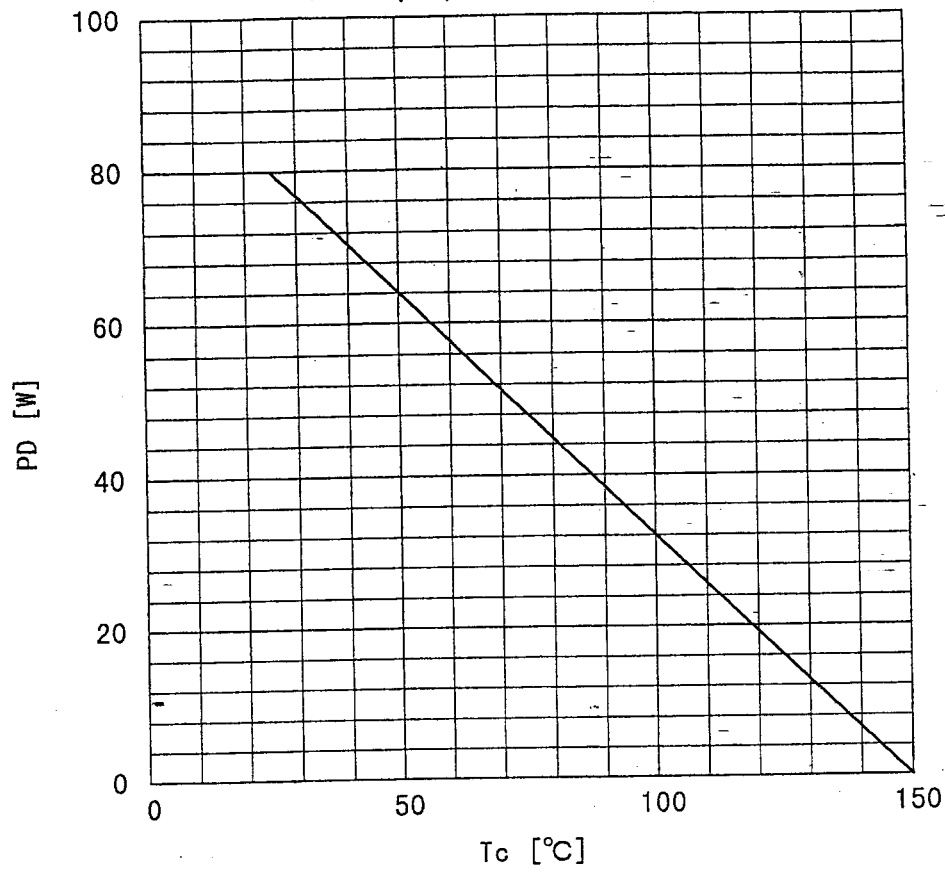

Safe operating area
 $ID=f(V_{DS}) : D=0.01, T_c=25^\circ C$

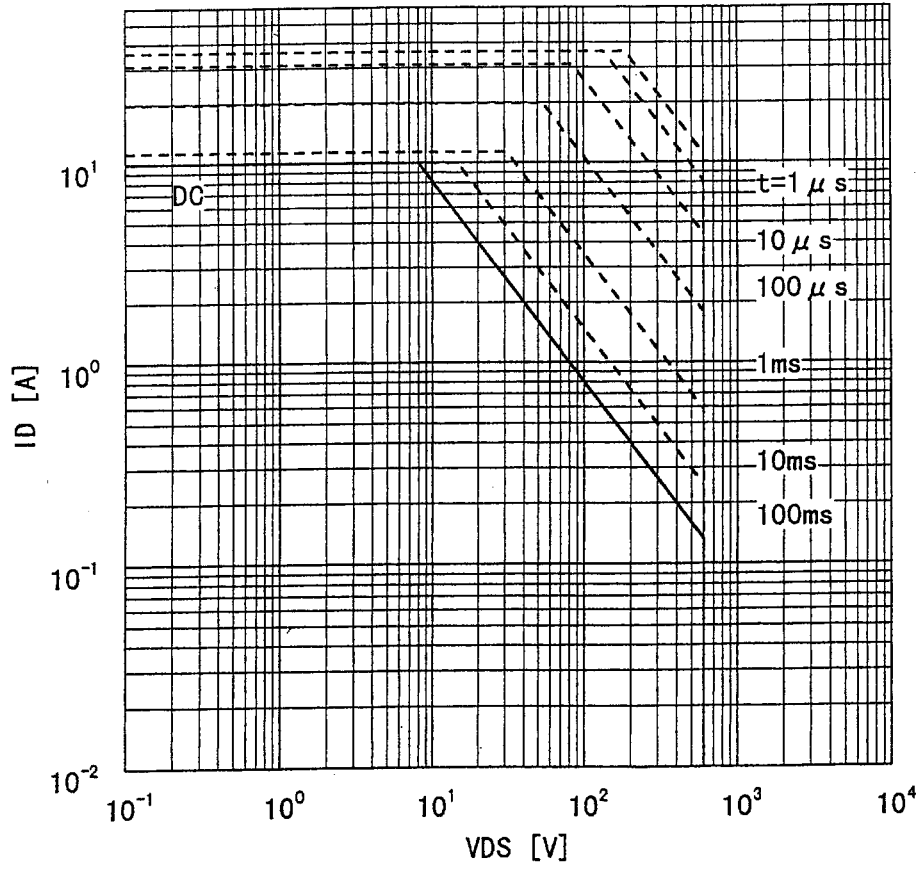

Fuji Electric Co., Ltd.

DWG. NO.

MS5F4207

6/12

a

This material and the information herein is the property of Fuji Electric Co., Ltd. They shall be neither reproduced, copied, lent, or disclosed in any way whatsoever for the use of any third party nor used for the manufacturing purposes without the express written consent of Fuji Electric Co., Ltd.

Typical output characteristics
 $I_D = f(V_{DS}) : 80 \mu s$ pulse test, $T_c = 25^\circ C$

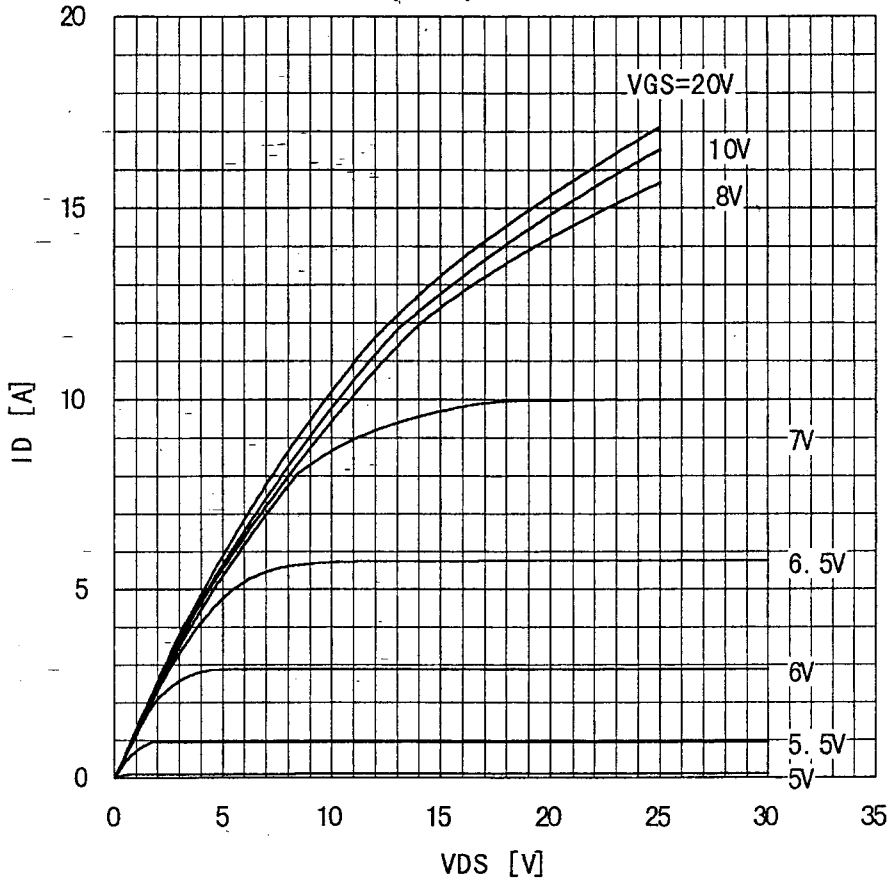

Typical transfer characteristic
 $I_D = f(V_{GS}) : 80 \mu s$ pulse test, $V_{DS} = 25V$, $T_{ch} = 25^\circ C$

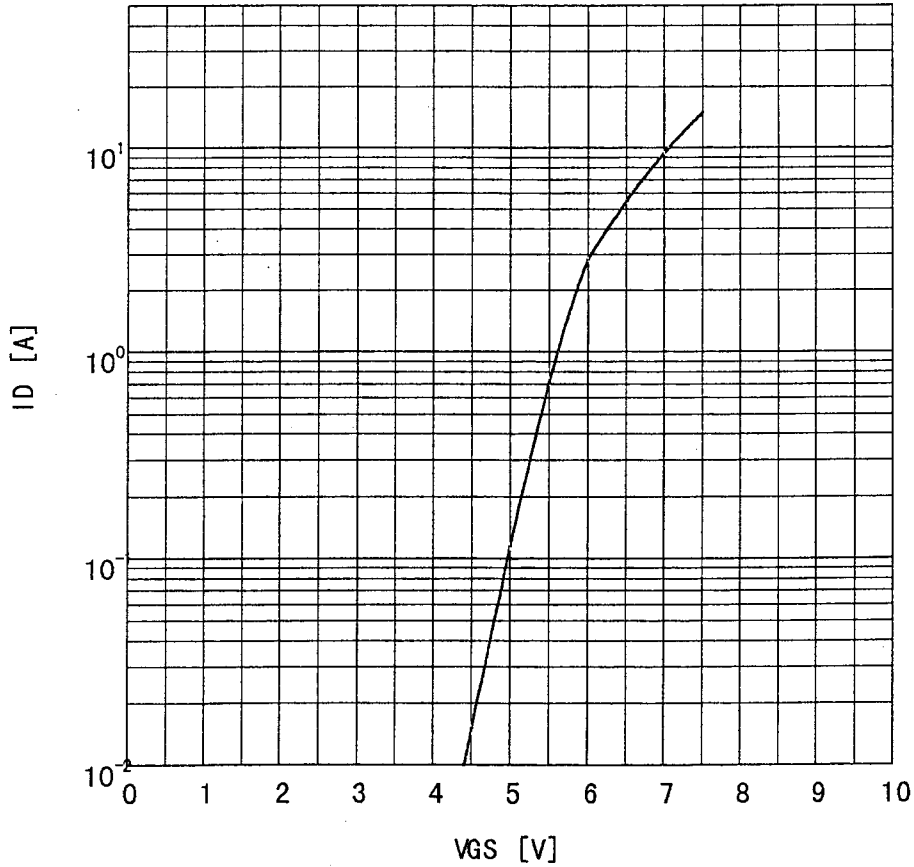

Fuji Electric Co., Ltd.

DWG. NO.

MS5F4207

7/12

a

Typical forward transconductance
 $g_{fs} = f(I_D) : 80 \mu s$ pulse test, $V_{DS} = 25V$, $T_{ch} = 25^\circ C$

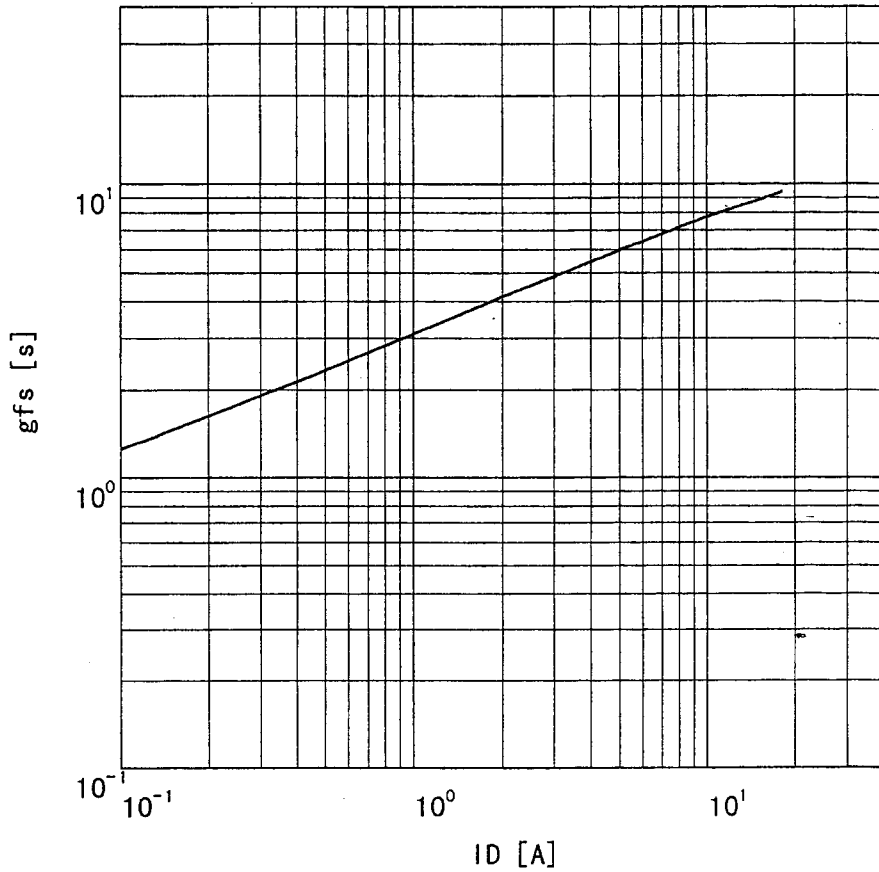

Typical drain-source on-state resistance
 $R_{DS(on)} = f(I_D) : 80 \mu s$ pulse test, $T_c = 25^\circ C$

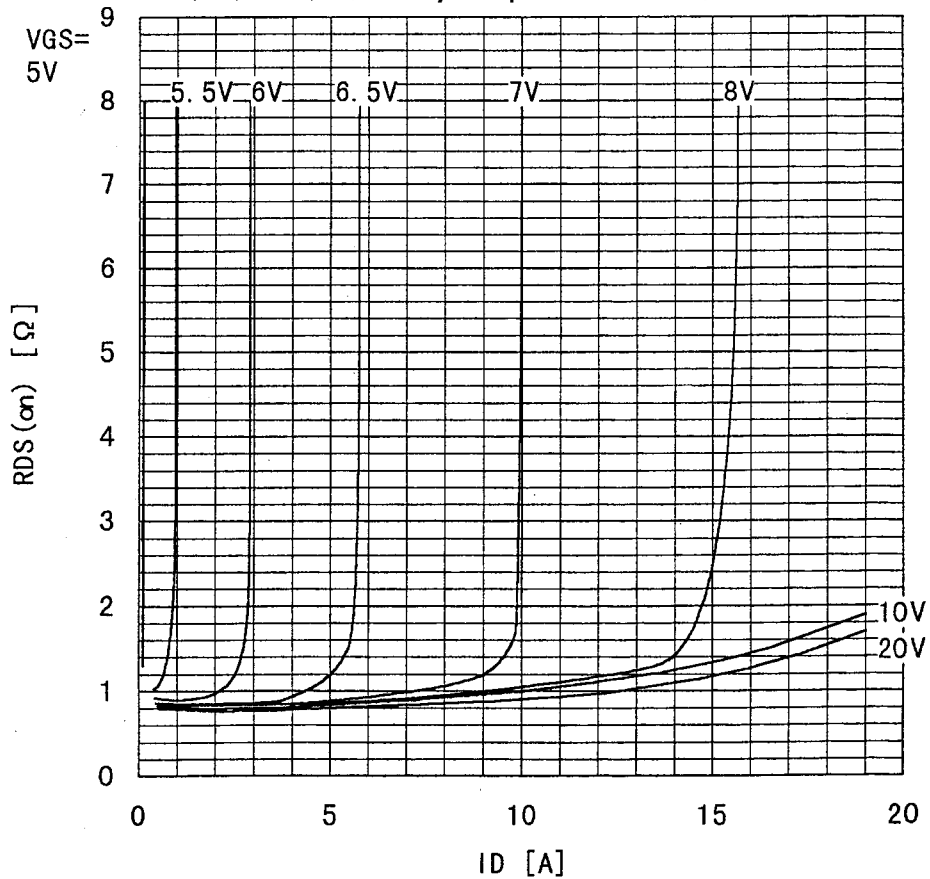

Fuji Electric Co., Ltd.

DWG. NO.

MS5F4207

8/12

Λ

This material and the information herein is the property of Fuji Electric Co., Ltd. They shall be neither reproduced, copied, lent, or disclosed in any way whatsoever for the use of any third party nor used for the manufacturing purposes without the express written consent of Fuji Electric Co., Ltd.

This material and the information herein is the property of Fuji Electric Co., Ltd. They shall be neither reproduced, copied, lent, or disclosed in any way whatsoever for the use of any third party nor used for the manufacturing purposes without the express written consent of Fuji Electric Co., Ltd.

Drain-source on-state resistance

$R_{DS(on)} = f(T_{ch}) : I_D = 4.5A, V_{GS} = 10V$

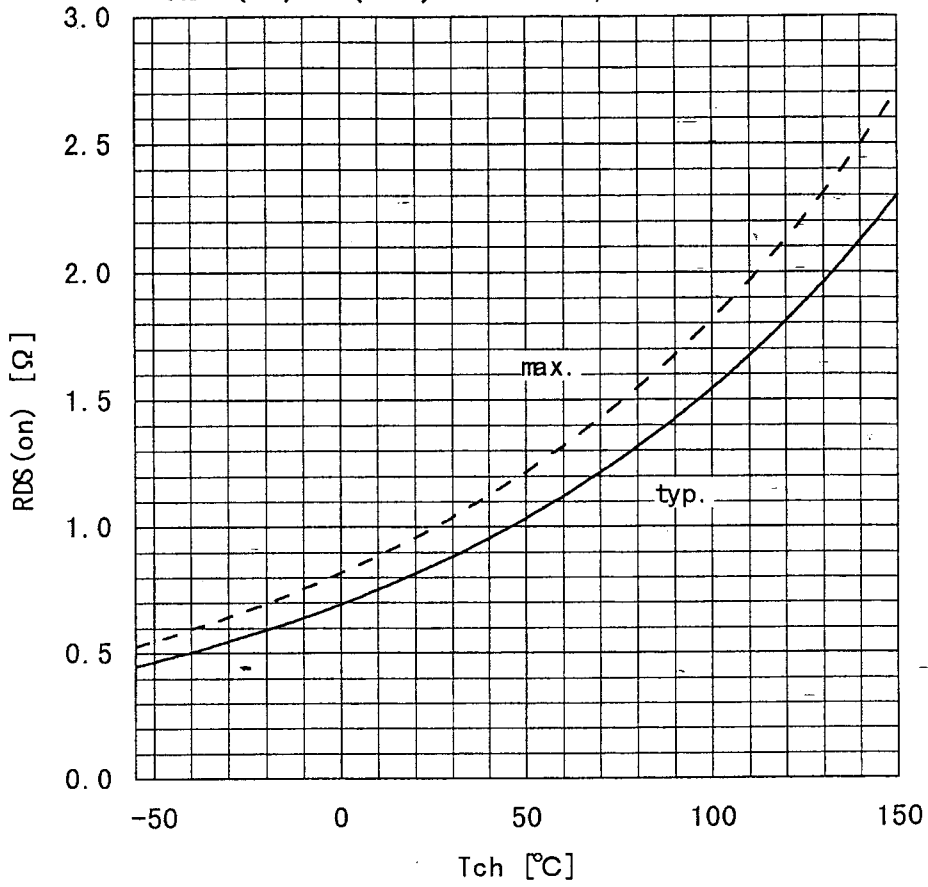

Gate threshold voltage

$V_{GS(th)} = f(T_{ch}) : I_D = 1mA, V_{DS} = V_{GS}$

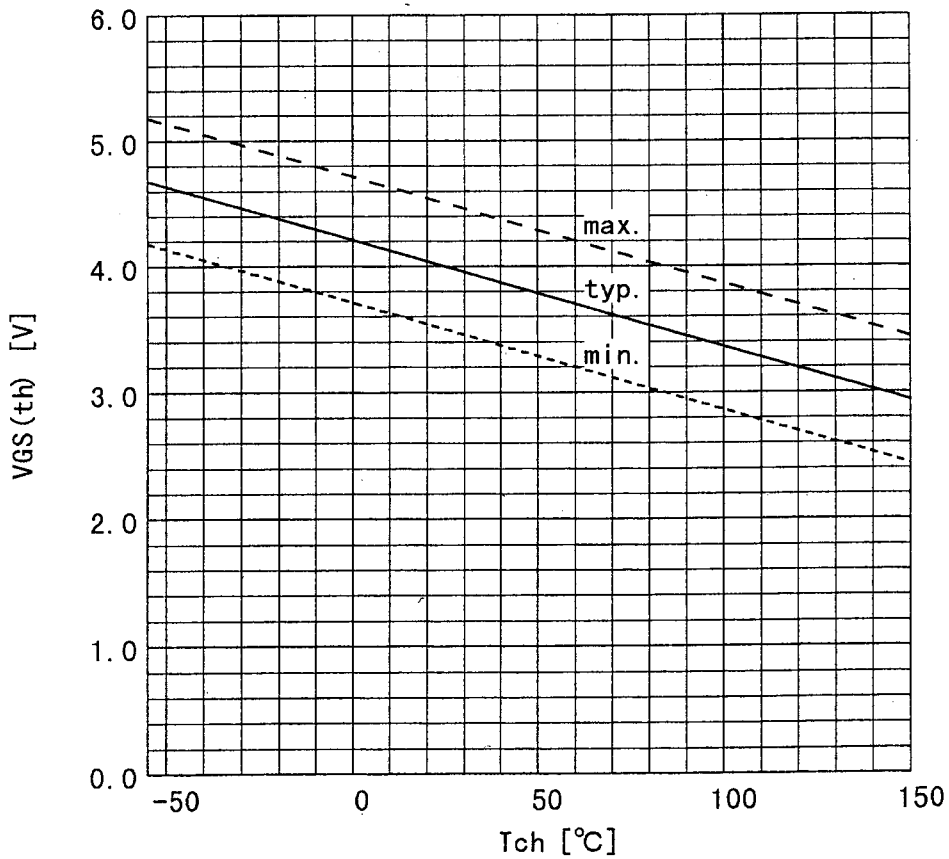

Fuji Electric Co., Ltd.

DWG. NO.

MS5F4207

9/12

A

This material and the information herein is the property of Fuji Electric Co., Ltd. They shall be neither reproduced, copied, lent, or disclosed in any way whatsoever for the use of any third party nor used for the manufacturing purposes without the express written consent of Fuji Electric Co., Ltd.

Typical gate charge characteristic
 $V_{GS} = f(Q_g) : I_D = 10A, T_c = 25^\circ C$

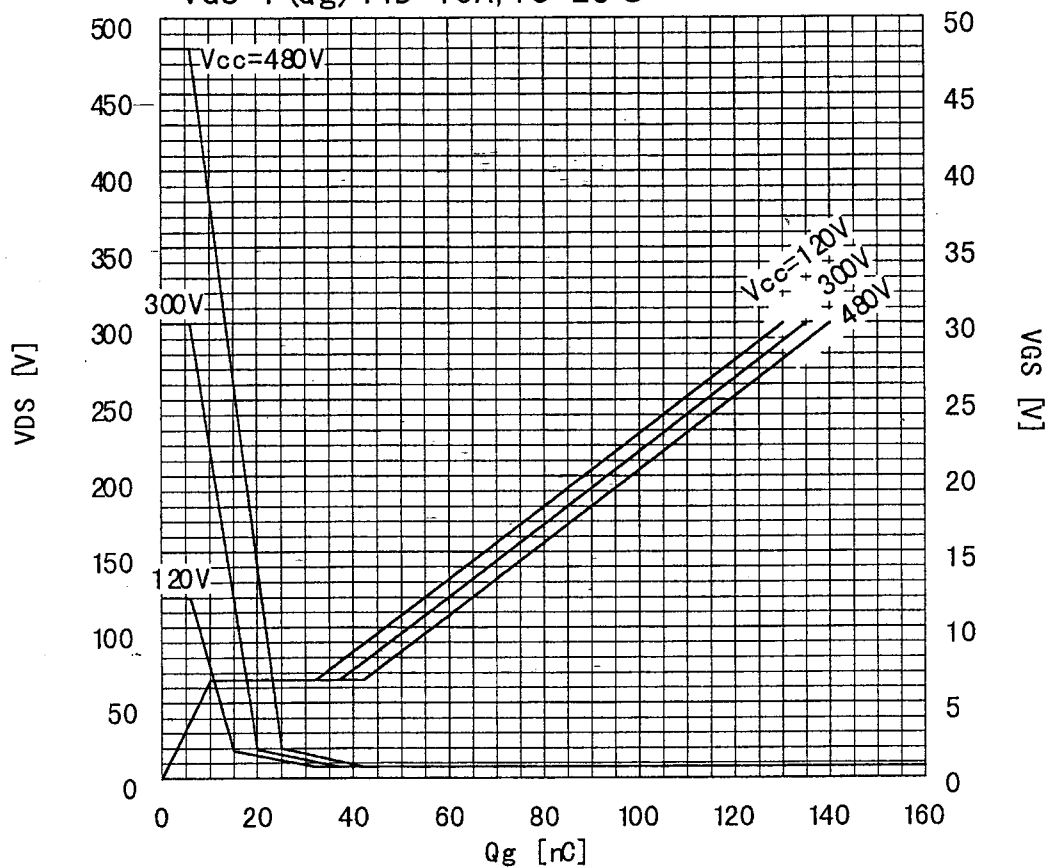

Typical capacitances

$C = f(V_{DS}) : V_{GS} = 0V, f = 1MHz$

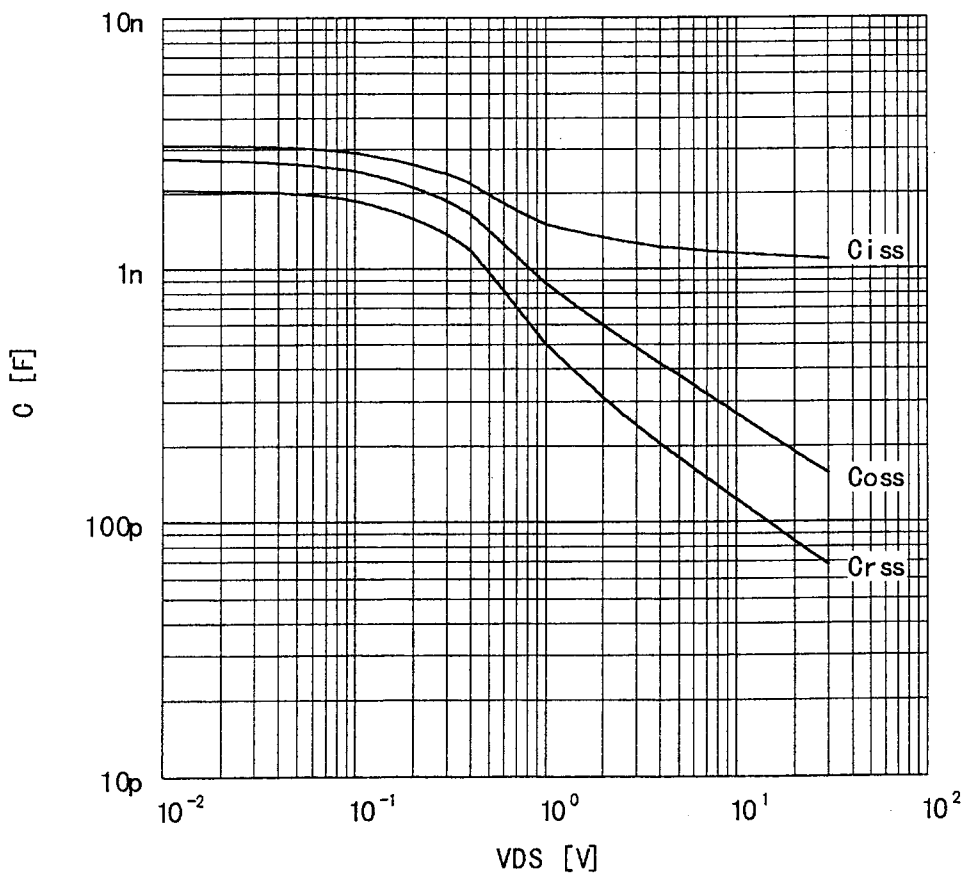

Forward characteristic of reverse of diode
 $I_F=f(V_{SD}) : 80 \mu s$ pulses test, $V_{GS}=0V$

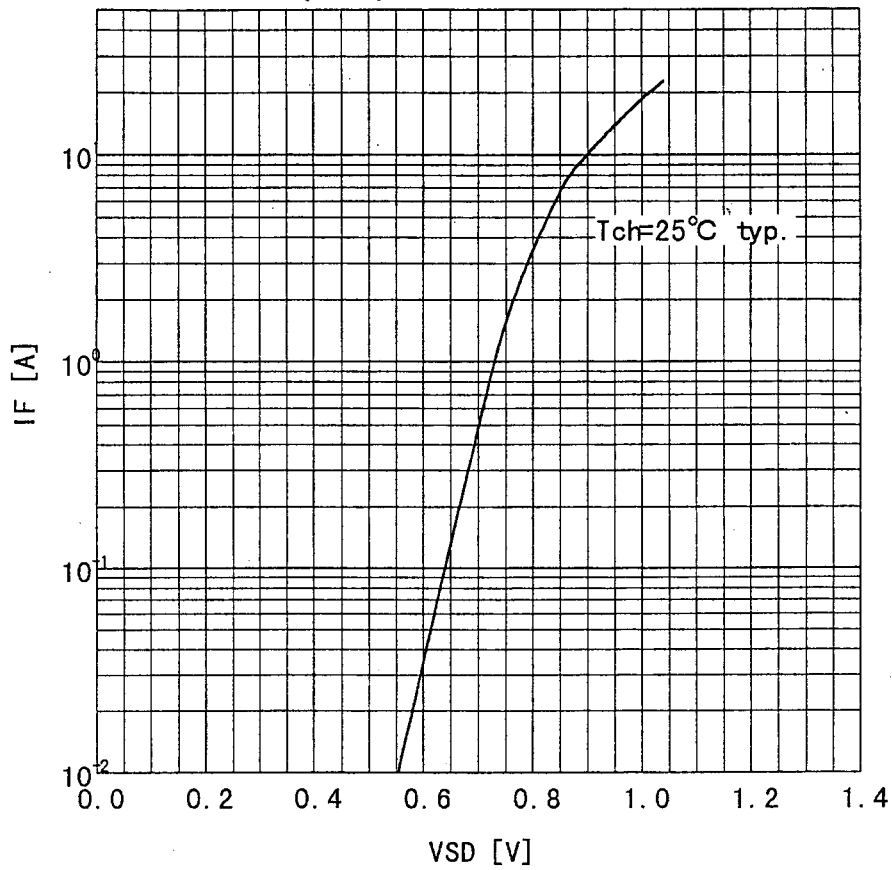

TO-3PF/80W Transient Thermal Impedance

$Z_{th(ch-c)}=f(t) : D=t/T$

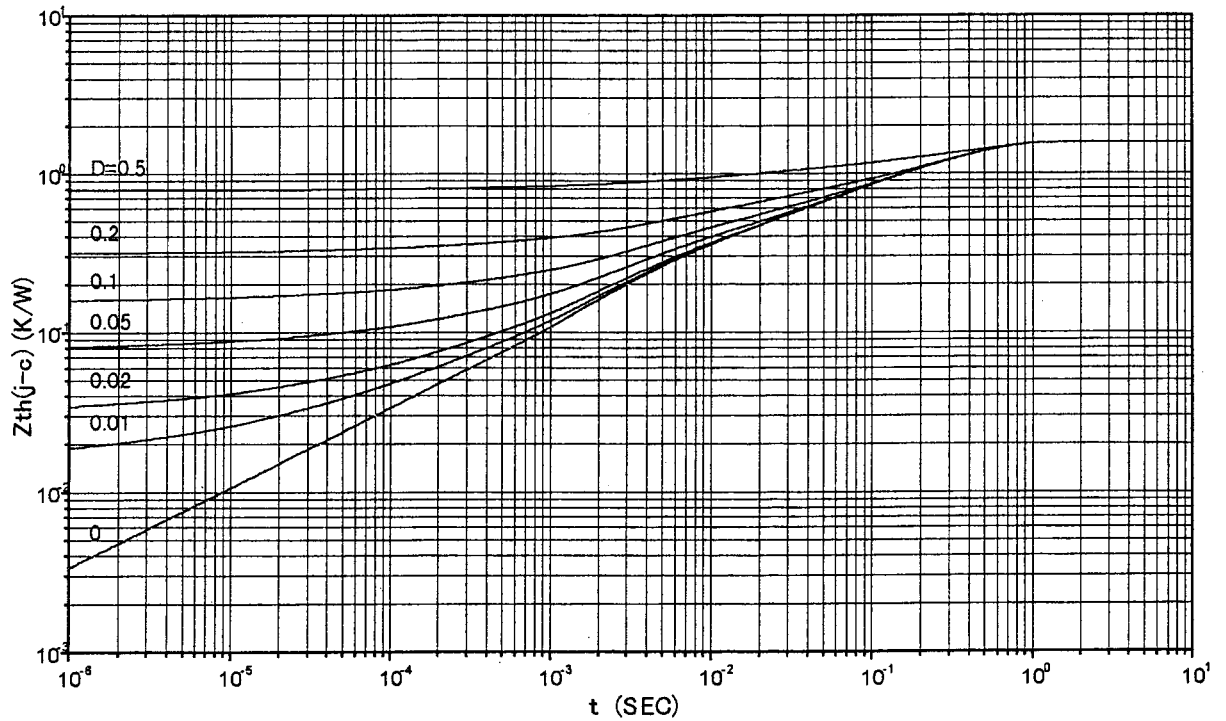

改訂 97/5/16 T.SHIMATOH

Fuji Electric Co.,Ltd.

DWG.NO.

MS5F4207

11/12

This material and the information herein is the property of Fuji Electric Co.,Ltd. They shall be neither reproduced, copied, lent, or disclosed in any way whatsoever for the use of any third party nor used for the manufacturing purposes without the express written consent of Fuji Electric Co.,Ltd.

This material and the information herein is the property of Fuji Electric Co., Ltd. They shall be neither reproduced, copied, lent, or disclosed in any way whatsoever for the use of any third party nor used for the manufacturing purposes without the express written consent of Fuji Electric Co., Ltd.

Avalanche energy derating
 $E_{as} = f(\text{starting } T_{ch}) : V_{CC} = 60V, I_A = 10A$

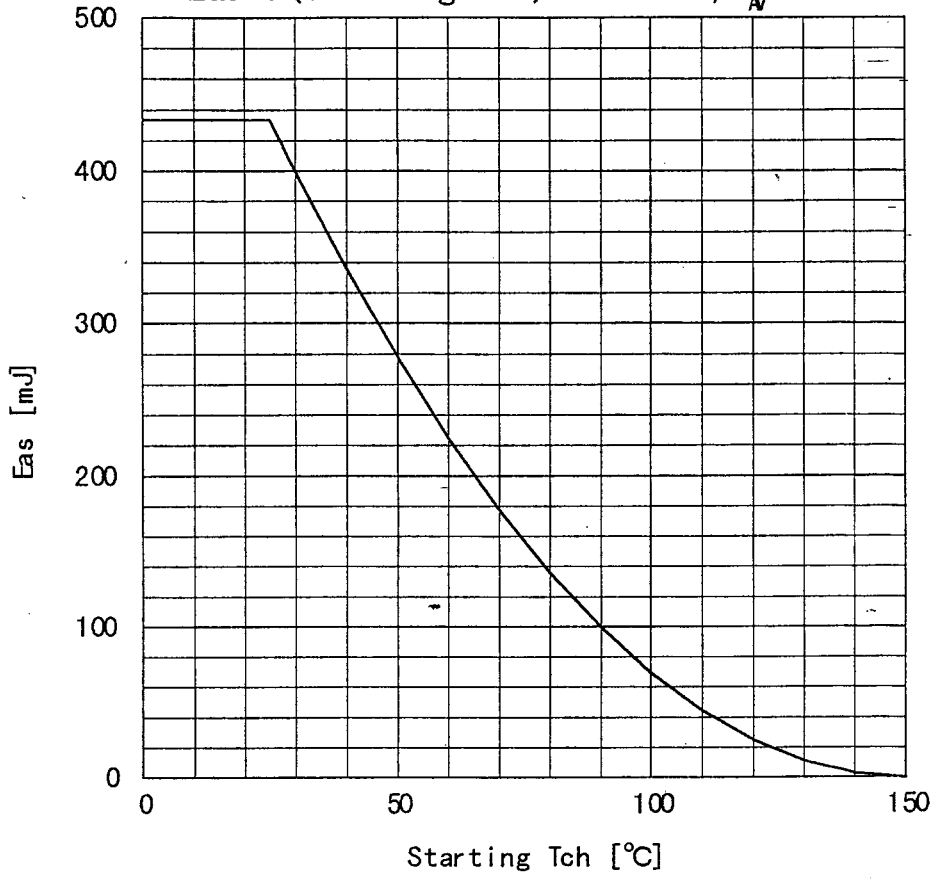

Fuji Electric Co., Ltd.

DWG. NO.

MS5F4207

12/12
