

## Digital Indicators **K3HB-R/-P/-C**

### User's Manual

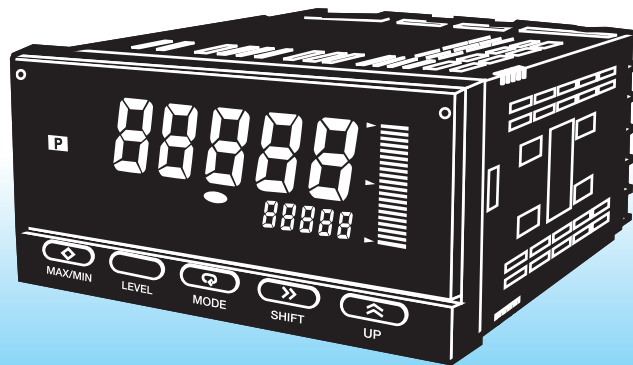



# Preface

---

OMRON products are manufactured for use according to proper procedures by a qualified operator and only for the purposes described in this manual.

This manual describes the functions, performance, and application methods needed for optimum use of the K3HB.

Please observe the following items when using the K3HB.

- This product is designed for use by qualified personnel with a knowledge of electrical systems.
- Read this manual carefully and make sure you understand it well to ensure that you are using the K3HB correctly.
- Keep this manual in a safe location so that it is available for reference when required.

## **Notice**

- (1) All rights reserved. No part of this manual may be reprinted or copied without the prior written permission of OMRON.
- (2) The specifications and other information contained in this manual are subject to change without notice in order to make improvements.
- (3) Every precaution has been taken in the preparation of this manual. Nevertheless, OMRON assumes no responsibility for errors or omissions. If you discover any problems with this manual, please notify your nearest OMRON representative, providing them with the catalog number provided on the cover.

# ***Terms and Conditions Agreement***

## ***Read and understand this Manual***

Please read and understand this catalog before purchasing the products. Please consult your OMRON representative if you have any questions or comments.

## ***Warranty, Limitations of Liability***

### **Warranties**

- **Exclusive Warranty** Omron's exclusive warranty is that the Products will be free from defects in materials and workmanship for a period of twelve months from the date of sale by Omron (or such other period expressed in writing by Omron). Omron disclaims all other warranties, express or implied.
  
- **Limitations** OMRON MAKES NO WARRANTY OR REPRESENTATION, EXPRESS OR IMPLIED, ABOUT NON-INFRINGEMENT, MERCHANTABILITY OR FITNESS FOR A PARTICULAR PURPOSE OF THE PRODUCTS. BUYER ACKNOWLEDGES THAT IT ALONE HAS DETERMINED THAT THE PRODUCTS WILL SUITABLY MEET THE REQUIREMENTS OF THEIR INTENDED USE.  
Omron further disclaims all warranties and responsibility of any type for claims or expenses based on infringement by the Products or otherwise of any intellectual property right.
  
- **Buyer Remedy** Omron's sole obligation hereunder shall be, at Omron's election, to (i) replace (in the form originally shipped with Buyer responsible for labor charges for removal or replacement thereof) the non-complying Product, (ii) repair the non-complying Product, or (iii) repay or credit Buyer an amount equal to the purchase price of the non-complying Product; provided that in no event shall Omron be responsible for warranty, repair, indemnity or any other claims or expenses regarding the Products unless Omron's analysis confirms that the Products were properly handled, stored, installed and maintained and not subject to contamination, abuse, misuse or inappropriate modification. Return of any Products by Buyer must be approved in writing by Omron before shipment. Omron Companies shall not be liable for the suitability or unsuitability or the results from the use of Products in combination with any electrical or electronic components, circuits, system assemblies or any other materials or substances or environments. Any advice, recommendations or information given orally or in writing, are not to be construed as an amendment or addition to the above warranty.

See <http://www.omron.com/global/> or contact your Omron representative for published information.

### **Limitation on Liability; Etc**

OMRON COMPANIES SHALL NOT BE LIABLE FOR SPECIAL, INDIRECT, INCIDENTAL, OR CONSEQUENTIAL DAMAGES, LOSS OF PROFITS OR PRODUCTION OR COMMERCIAL LOSS IN ANY WAY CONNECTED WITH THE PRODUCTS, WHETHER SUCH CLAIM IS BASED IN CONTRACT, WARRANTY, NEGLIGENCE OR STRICT LIABILITY.

Further, in no event shall liability of Omron Companies exceed the individual price of the Product on which liability is asserted.

# ***Application Considerations***

## **Suitability of Use**

Omron Companies shall not be responsible for conformity with any standards, codes or regulations which apply to the combination of the Product in the Buyer's application or use of the Product. At Buyer's request, Omron will provide applicable third party certification documents identifying ratings and limitations of use which apply to the Product. This information by itself is not sufficient for a complete determination of the suitability of the Product in combination with the end product, machine, system, or other application or use. Buyer shall be solely responsible for determining appropriateness of the particular Product with respect to Buyer's application, product or system. Buyer shall take application responsibility in all cases.

NEVER USE THE PRODUCT FOR AN APPLICATION INVOLVING SERIOUS RISK TO LIFE OR PROPERTY WITHOUT ENSURING THAT THE SYSTEM AS A WHOLE HAS BEEN DESIGNED TO ADDRESS THE RISKS, AND THAT THE OMRON PRODUCT(S) IS PROPERLY RATED AND INSTALLED FOR THE INTENDED USE WITHIN THE OVERALL EQUIPMENT OR SYSTEM.

## **Programmable Products**

Omron Companies shall not be responsible for the user's programming of a programmable Product, or any consequence thereof.

# ***Disclaimers***

## **Performance Data**

Data presented in Omron Company websites, catalogs and other materials is provided as a guide for the user in determining suitability and does not constitute a warranty. It may represent the result of Omron's test conditions, and the user must correlate it to actual application requirements. Actual performance is subject to the Omron's Warranty and Limitations of Liability.

## **Change in Specifications**

Product specifications and accessories may be changed at any time based on improvements and other reasons. It is our practice to change part numbers when published ratings or features are changed, or when significant construction changes are made. However, some specifications of the Product may be changed without any notice. When in doubt, special part numbers may be assigned to fix or establish key specifications for your application. Please consult with your Omron's representative at any time to confirm actual specifications of purchased Product.

## **Errors and Omissions**

Information presented by Omron Companies has been checked and is believed to be accurate; however, no responsibility is assumed for clerical, typographical or proofreading errors or omissions.

## Safety Precautions

### ● Definition of Precautionary Information

The following notation is used in this manual to provide precautions required to ensure safe usage of the product.





The safety precautions that are provided are extremely important to safety. Always read and heed the information provided in all safety precautions.

The following notation is used.



 <b>WARNING</b>	<p>Indicates a potentially hazardous situation which, if not avoided, will result in minor or moderate injury, or may result in serious injury or death. Additionally there may be significant property damage.</p>
--	---



 <b>CAUTION</b>	<p>Indicates a potentially hazardous situation which, if not avoided, may result in minor or moderate injury or in property damage.</p>
--	---

### ● Symbols

Symbol		Meaning
Caution		<p><b>General Caution</b> Indicates non-specific general cautions, warnings, and dangers.</p>
		<p><b>Electrical Shock Caution</b> Indicates possibility of electric shock under specific conditions.</p>
Prohibition		<p><b>General Prohibition</b> Indicates non-specific general prohibitions.</p>
Mandatory Caution		<p><b>General Caution</b> Indicates non-specific general cautions, warnings, and dangers.</p>

● Precautions

 <b>WARNING</b>	
Do not touch the terminals while power is being supplied. Doing so may possibly result in electric shock. Make sure that the terminal cover is installed before using the product.	
Always provide protective circuits in the network. Without protective circuits, malfunctions may possibly result in accidents that cause serious injury or significant property damage. Provide double or triple safety measures in external control circuits, such as emergency stop circuits, interlock circuits, or limit circuits, to ensure safety in the system if an abnormality occurs due to malfunction of the product or another external factor affecting the product's operation.	

 <b>CAUTION</b>	
Do not allow pieces of metal, wire clippings, or fine metallic shavings or filings from installation to enter the product. Doing so may occasionally result in electric shock, fire, or malfunction.	
Do not use the product in locations where flammable or explosive gases are present. Doing so may occasionally result in minor or moderate explosion, causing minor or moderate injury, or property damage.	
Do not attempt to disassemble, repair, or modify the product. Doing so may occasionally result in minor or moderate injury due to electric shock.	
Do not use the equipment for measurements within Measurement Categories II, III, and IV for K3HB-R, K3HB-P, and K3HB-C (according to IEC61010-1). Doing so may occasionally cause unexpected operation, resulting in minor or moderate injury, or damage to the equipment. Use the equipment for measurements only within the Measurement Category for which the product is designed.	
Perform correct setting of the product according to the application. Failure to do so may occasionally cause unexpected operation, resulting in minor or moderate injury, or damage to the equipment.	
Ensure safety in the event of product failure by taking safety measures, such as installing a separate monitoring system. Product failure may occasionally prevent operation of comparative outputs, resulting in damage to the connected facilities and equipment.	
Tighten the screws on the terminal block and the connector locking screws securely using a tightening torque within the following ranges. Loose screws may occasionally cause fire, resulting in minor or moderate injury, or damage to the equipment. Terminal block screws: 0.43 to 0.58 N·m Connector locking screws: 0.18 to 0.22 N·m	

 **CAUTION**

Make sure that the product will not be adversely affected if the DeviceNet cycle time is lengthened as a result of changing the program with online editing. Extending the cycle time may cause unexpected operation, occasionally resulting in minor or moderate injury, or damage to the equipment.

Before transferring programs to other nodes or changing I/O memory of other nodes, check the nodes to confirm safety. Changing the program or I/O memory of other nodes may occasionally cause unexpected operation, resulting in minor or moderate injury, or damage to the equipment.





## Precautions for Safe Use

- (1) Do not use the product in the following locations.
  - Locations subject to direct radiant heat from heating equipment
  - Locations where the product may come into contact with water or oil
  - Locations subject to direct sunlight
  - Locations where dust or corrosive gases (in particular, sulfuric or ammonia gas) are present
  - Locations subject to extreme temperature changes
  - Locations where icing or condensation may occur
  - Locations subject to excessive shocks or vibration
- (2) Do not use the product in locations subject to temperatures or humidity levels outside the specified ranges or in locations prone to condensation. If the product is installed in a panel, ensure that the temperature around the product (not the temperature around the panel) does not go outside the specified range.
- (3) Provide sufficient space around the product for heat dissipation.
- (4) Use and store the product within the specified temperature and humidity ranges. If several products are mounted side-by-side or arranged in a vertical line, the heat dissipation will cause the internal temperature of the products to rise, shortening the service life. If necessary, cool the products using a fan or other cooling method.
- (5) The service life of the output relays depends on the switching capacity and switching conditions. Consider the actual application conditions and use the product within the rated load and electrical service life. Using the product beyond its service life may result in contact welding or burning.
- (6) Install the product horizontally.
- (7) Mount to a panel between 1 and 8-mm thick.
- (8) Use the specified size of crimp terminals (M3, width: 5.8 mm max.) for wiring. To connect bare wires, use AWG22 (cross section: 0.326 mm<sup>2</sup>) to AWG14 (cross section: 2.081 mm<sup>2</sup>) to wire the power supply terminals and AWG28 (cross section: 0.081 mm<sup>2</sup>) to AWG16 (cross section: 1.309 mm<sup>2</sup>) for other terminals. (Length of exposed wire: 6 to 8 mm)
- (9) In order to prevent inductive noise, wire the lines connected to the product separately from power lines carrying high voltages or currents. Do not wire in parallel with or in the same cable as power lines. Other measures for reducing noise include running lines along separate ducts and using shield lines.
- (10) Ensure that the rated voltage is achieved no longer than 2 s after turning the power ON.
- (11) Allow the product to operate without load for at least 15 minutes after the power is turned ON.
- (12) Do not install the product near devices generating strong high-frequency waves or surges. When using a noise filter, check the voltage and current and install it as close to the product as possible.
- (13) Do not use thinner to clean the product. Use commercially available alcohol.
- (14) Be sure to confirm the name and polarity for each terminal before wiring the terminal block and connectors.
- (15) Use the product within the noted supply voltage and rated load.

- (16) Do not connect anything to unused terminals.
- (17) Output turns OFF when the mode is changed or settings are initialized. Take this into consideration when setting up the control system.
- (18) Install an external switch or circuit breaker that complies with applicable IEC60947-1 and IEC60947-3 requirements and label them clearly so that the operator can quickly turn OFF the power.
- (19) Use the specified cables for the communications lines and stay within the specified DeviceNet communications distances. Refer to the User's Manual (Cat. No. N129) for details on communications distance specifications and cables.
- (20) Do not pull the DeviceNet communications cables with excessive force or bend them past their natural bending radius.
- (21) Do not connect or remove connectors while the DeviceNet power is being supplied. Doing so will cause product failure or malfunction.
- (22) Use cables with a heat resistance specification of 70°C min.

## ● Noise Countermeasures

Do not install the product near devices generating strong high-frequency waves or surges, such as high-frequency welding and sewing machines.

- (1) Mount a surge suppressor or noise filter to peripheral devices generating noise, in particular, motors, transformers, solenoids, and magnet coils.

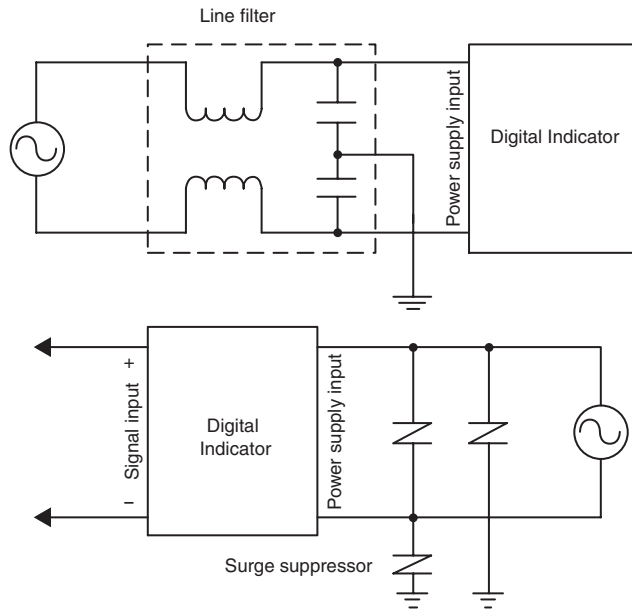

- (2) In order to prevent inductive noise, wire the lines connected to the terminal block separately from power lines carrying high voltages or currents. Do not wire in parallel with or in the same cable as power lines. Other measures for reducing noise include running lines along separate ducts and using shield lines.

### Example of Countermeasures for Inductive Noise on Input Lines

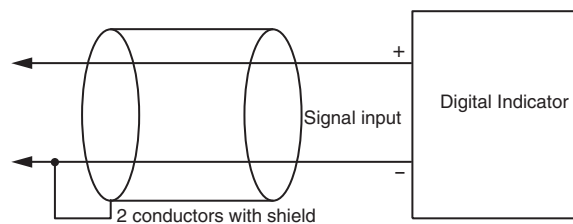

- (3) If a noise filter is used for the power supply, check the voltage and current, and install the noise filter as close to the product as possible.
- (4) Reception interference may occur if the product is used close to a radio, television, or wireless.

## ● Revision History

The revision code of this manual is given at the end of the catalog number at the bottom left of the back cover.

Cat. No.	N136-E1-03
----------	------------

Revision code	Date	Pages and changes
01	October 2004	Original production
01A	March 2005	<p><b>Page 2-4:</b> Changed “B4” to “BCD,” and changed diagrams.</p> <p><b>Page A-4 and A-5:</b> Changed “Meter” to “Indicator” in tables.</p> <p><b>Page A-7:</b> Changed “meter” to “indicator,” and “B4” to “BCD” in table, and added note.</p> <p><b>Page A-17 to A-22:</b> Changed “B4” to “BCD” in table.</p>
01B	October 2007	<p><b>Page 2-4:</b> Changed figure in upper left corner and at bottom of page.</p> <p><b>Page 2-9:</b> Added table.</p> <p><b>Pages 2-10 to 2-12:</b> Changed figures and added notes.</p> <p><b>Page 5-23:</b> Added “prescale value B” and added note.</p> <p><b>Page 5-27:</b> Changed left column of top four rows of table.</p> <p><b>Page 5-28:</b> Changed sentence under first table.</p> <p><b>Page 5-71:</b> Changed text in bottom table (including present values under figures).</p> <p><b>Page INDEX-1:</b> Added and corrected index entries.</p>
02	November 2010	<p><b>Page 3-2:</b> Correct end of formula for prescale value.</p> <p><b>Page 5-57:</b> Changed figures and removed paragraph from below second figure.</p> <p><b>Page 5-58:</b> Added material to note.</p> <p><b>Page A-4:</b> Change description of measurement ranges.</p> <p><b>INDEX-2:</b> Removed “Operation at input error.”</p>
03	September 2013	<p><b>Pages 1-5 and 1-6:</b> Changed description of MAX/MIN Key.</p> <p><b>Page 2-6:</b> Added note to <i>Linear Outputs</i>.</p> <p><b>Page 3-8:</b> Removed last row from third table.</p> <p><b>Page 5-14:</b> Removed last sentence on page and added note.</p> <p><b>Page 5-15:</b> Added table.</p> <p><b>Pages 5-16 and 5-18 to 5-21:</b> Changed 1 ms to 20 ms.</p> <p><b>Page 5-31:</b> Changed text above and below table.</p> <p><b>Page 5-33:</b> Added heading and section.</p> <p><b>Page 5-36:</b> Added text to figure and changed figure for <i>Simple Average</i>.</p> <p><b>Page 5-84:</b> Changed “five” to “four” at top of page.</p>

# About this Manual

---

## **Manual Structure**

### **Preface**

Provides precautionary information, a manual revision history, an overview of the manual contents, information on using this manual, and other general information.

### **Section 1 Outline**

Provides an overview and describes the features of the product.

### **Section 2 Preparations**

Describes the mounting and wiring required before using the product.

### **Section 3 Basic Application Methods**

Shows typical applications for the product. Also shows wiring and parameter settings which enables the user to understand how to use the product from practical examples.

### **Section 4 Initial Setup**

Describes the initial setup process when using this product.

### **Section 5 Functions and Operations**

Describes the functions and settings methods for more effective use of functions, displays, outputs, and settings for each application.

### **Section 6 Troubleshooting**

Describes how to check and possible countermeasures for errors.

### **Appendices**

Provides specifications and settings lists.

## ● Settings Data Notation

The letters of the alphabet in settings data are displayed as shown below.

<i>A</i>	<i>b</i>	<i>c</i>	<i>d</i>	<i>E</i>	<i>F</i>	<i>G</i>	<i>H</i>	<i>i</i>	<i>j</i>	<i>K</i>	<i>L</i>	<i>M</i>
A	B	C	D	E	F	G	H	I	J	K	L	M

<i>n</i>	<i>o</i>	<i>P</i>	<i>q</i>	<i>r</i>	<i>S</i>	<i>t</i>	<i>U</i>	<i>v</i>	<i>W</i>	<i>X</i>	<i>Y</i>	<i>Z</i>
N	O	P	Q	R	S	T	U	V	W	X	Y	Z

## ● Applicable Model Notation

The following symbols are used to indicate the applicable models for specific functions.

- R** K3HB-R□□-□□□
- P** K3HB-P□□-□□□
- C** K3HB-C□□-□□□

# CONTENTS

## Section 1 Outline

1.1	Main Functions and Features of the K3HB .....	1-2
1.2	Component Names and Functions of the K3HB-R/P .....	1-5
1.3	Component Names and Functions of the K3HB-C .....	1-6
1.4	Internal Block Diagram .....	1-7

## Section 2 Preparations

2.1	Mounting .....	2-2
2.2	Using I/O .....	2-4

## Section 3 Basic Application Methods

3.1	Monitoring Roller Speed: K3HB-R .....	3-2
3.2	Monitoring Conveyor Speed Difference: K3HB-R .....	3-4
3.3	Monitoring Conveyor Line Passing Time: K3HB-R .....	3-7
3.4	Measuring the Operation Time of a Press: K3HB-P .....	3-9
3.5	Measuring Workpiece Passing Time between Points A and B: K3HB-P .....	3-11
3.6	Measuring the Feed Length of a Sheet: K3HB-C .....	3-13
3.7	Counting the Number of Workpieces: K3HB-C .....	3-15

## Section 4 Initial Setup

4.1	Initial Setup Example for the K3HB-R .....	4-2
4.2	Initial Setup Example for the K3HB-P .....	4-4
4.3	Initial Setup Example for the K3HB-C .....	4-6

## Section 5 Functions and Operations

	Section 5 Knowledge Required for Setting Parameters .....	5-2
5.1	Setting the Function for the K3HB-R .....	5-9
5.2	Setting the Function for the K3HB-P .....	5-17
5.3	Setting the Function for the K3HB-C .....	5-24
5.4	Setting Input Types .....	5-28
5.5	Setting Prescale Values .....	5-29
5.6	Setting the Auto-zero Time .....	5-32
5.7	Resetting Measurements .....	5-34
5.8	Not Performing Measurements for Set Intervals .....	5-35
5.9	Averaging Input .....	5-37
5.10	Changing Comparative Output Patterns .....	5-40
5.11	Preventing Output Chattering .....	5-43
5.12	Outputting for a Set Interval .....	5-45
5.13	Delaying Output OFF Timing .....	5-47

5.14	Holding Measurement Status . . . . .	5-49
5.15	Holding Comparative Outputs . . . . .	5-50
5.16	Allocating Another Output to PASS Output . . . . .	5-52
5.17	Reversing Output Logic . . . . .	5-54
5.18	No Output before PASS Range. . . . .	5-56
5.19	Performing Linear Output . . . . .	5-58
5.20	Changing the Display Refresh Period . . . . .	5-61
5.21	Setting a Compensation Value for the Measurement Value . . . . .	5-62
5.22	Holding Measurement Values. . . . .	5-64
5.23	Holding Maximum and Minimum Values . . . . .	5-66
5.24	Changing Normal Display Values to Maximum and Minimum Values . . . . .	5-68
5.25	Displaying/Not Displaying Comparative Set Values . . . . .	5-69
5.26	Changing Display Colors . . . . .	5-70
5.27	Using the Position Meter . . . . .	5-72
5.28	Automatic Return to Normal Display . . . . .	5-74
5.29	Performing Output Tests. . . . .	5-75
5.30	Using Prescale/Comparative Set Value Banks . . . . .	5-76
5.31	Copying Bank Prescale Values. . . . .	5-82
5.32	Copying Bank Comparative Set Values . . . . .	5-83
5.33	Initializing All Settings. . . . .	5-84
5.34	Limiting Key Operations . . . . .	5-85

## Section 6 Troubleshooting

6.1	Error Displays. . . . .	6-2
6.2	Countermeasures . . . . .	6-3

## Appendices

Specifications . . . . .	A-2
Model Number Structure . . . . .	A-7
Parameter List. . . . .	A-8
Parameter Display Conditions . . . . .	A-17
About Parameters . . . . .	A-23
“No-Measurement” Status . . . . .	A-29
Forecasted Cycle Calculations . . . . .	A-30



# Section 1 Outline

1.1	Main Functions and Features of the K3HB.....	1-2
1.2	Component Names and Functions of the K3HB-R/P.....	1-5
1.3	Component Names and Functions of the K3HB-C.....	1-6
1.4	Internal Block Diagram .....	1-7

# 1.1 Main Functions and Features of the K3HB

## Measurement

### Functions of the K3HB-R

The K3HB-R has the following six functions for reading and displaying input pulses.

- F1: Rpm/circumferential speed
- F2: Absolute ratio
- F3: Error ratio
- F4: Rotational difference
- F5: Flow rate ratio
- F6: Passing time

→ P.5-9

R

### Functions of the K3HB-P

The K3HB-P has the following six functions for reading and displaying input pulses.

- F1: Passing speed
- F2: Cycle
- F3: Time difference
- F4: Time band
- F5: Measuring length
- F6: Interval

→ P.5-17

P

### Functions of the K3HB-C

The K3HB-C has the following three functions for reading and displaying input pulses.

- F1: Individual inputs
- F2: Phase differential inputs
- F3: Pulse counting input

→ P.5-24

C

## Filter

### Average processing

Average processing of input signals with extreme changes or noise smooths out the display and makes control stable.

→ P.5-37

R

### Input types

Specifies the sensor types connected to input A and input B.

→ P.5-28

R P C

## Input compensation

### Input compensation

The compensation input changes the display to the preset compensation value.

→ P.5-62

C

### Auto-zero time

Enables forced zeroing of the frequency when no pulse has been input for a specific period of time.

→ P.5-32

R

## Key operations

### Teaching

During scaling, the input value during measurement can be set, as is, as the scaling input value.

→ P.5-31  
(Setting Scaling)

R C

### Key protection

Limits key-operated level and parameter changes to prevent inadvertent key operations and malfunctions.

→ P.5-85

R P C

## Outputs

### Comparative output pattern

The comparative output pattern can be selected as standard output, zone output, and level output.

→ P.5-40

R P C

### PASS output change

Comparative results other than PASS and error signals can be output from the PASS output terminal.

→ P.5-52

R P

### Output logic

Reverses the output logic of comparative outputs for comparative results.

→ P.5-54

R P C

### Linear output

Outputs currents or voltages proportional to measurement values as they change.

→ P.5-58

R P C

## Display

### Display value selection

The current display value can be selected from the present value, the maximum value, and the minimum value.

→ P.5-68

R P C

### Position meter

Displays the current measurement value as a position in relation to the scaling width on a meter with 20 sections.

→ P.5-72

R P C

### Hysteresis

Prevents comparative output chattering when the measurement value fluctuates slightly near the set value.

→ P.5-43

R

### Output OFF delay

Connects the comparative output OFF timing for a set interval. Comparative output ON times can be held when comparative results change quickly.

→ P.5-47

R P C

### Startup compensation timer

Constant-time measurements can be stopped by an external signal input.

→ P.5-35

R

### Standby sequence

Turns the comparative output OFF until the measurement value enters the PASS range.

→ P.5-56

R P

### Output refresh stop

Holds the output status when comparative results outputs other than PASS turn ON.

→ P.5-50

R P

### Shot output

Produces a constant comparative output ON time.

→ P.5-45

R P C

### Output test

Output operation can be confirmed without actual input signals, by setting test measurement values using the keys.

→ P.5-75

R P C

### Display refresh period

When inputs change quickly, the display refresh period can be delayed to reduce flickering and make the display easier to read.

→ P.5-61

R P C

### Comparative set value display

The comparative set value can be set to not display during operation.

→ P.5-69

R P C

### Scaling

Can convert the input signal to any display value.

→ P.5-29

R P C

**Other****Max/Min hold**

Holds the maximum and minimum measurement values.

→ P.5-66

R P C

**Bank selection**

Eight comparative set value banks can be selected using the keys on the front of the Unit or by external inputs. Groups of comparative set values can be set and can be selected as groups.

→ P.5-76

R P C

**Bank copy**

Any bank setting can be copied to all banks.

→ P.5-82

R P C

**Interruption memory**

The measured value can be recorded when the power supply is interrupted.

→ P.5-64

C

## 1.2 Component Names and Functions of the K3HB-R/P

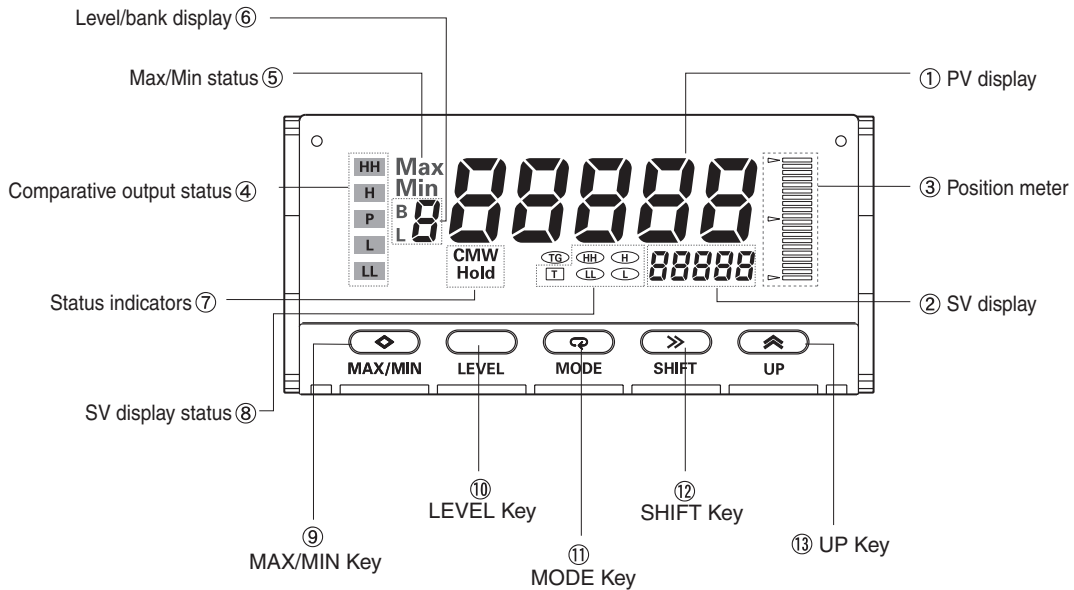

No.	Name	Function
①	PV display	Displays PVs, maximum values, minimum values, parameter names, and error names.
②	SV display	Displays SVs and monitor values.
③	Position meter	Displays the position of the PV with respect to a user-set scale.
④	Comparative output status indicators	Display the status of comparative outputs.
⑤	Max/Min status indicator	Turns ON when the maximum value or minimum value is displayed in RUN level.
⑥	Level/bank display	In RUN level, displays the bank if the bank function is ON. (Turns OFF if the bank function is OFF.) In other levels, displays the current level.
⑦	Status indicators	Hold: Turns ON/OFF when the hold input turns ON/OFF. CMW: Turns ON when communications writing is ON (enabled) and turns OFF when communications writing is OFF (prohibited).
⑧	SV display status indicators	T: Turns ON when a parameter for which teaching can be performed is displayed. HH, H, L, LL: In RUN level, turn ON when the comparative set values HH, H, L, and LL are displayed.
⑨	MAX/MIN Key	Used to switch the display between the PV, maximum value, and minimum value and to reset the PV, maximum value, and minimum value.
⑩	LEVEL Key	Used to switch the level.
⑪	MODE Key	Used to switch the displayed parameter.
⑫	SHIFT Key	Used to change parameter settings. When changing a set value, this key is used to move along the digits.
⑬	UP Key	When changing a set value, this key is used to change the actual value. When a measurement value is displayed, this key is used to execute teaching.

## 1.3 Component Names and Functions of the K3HB-C

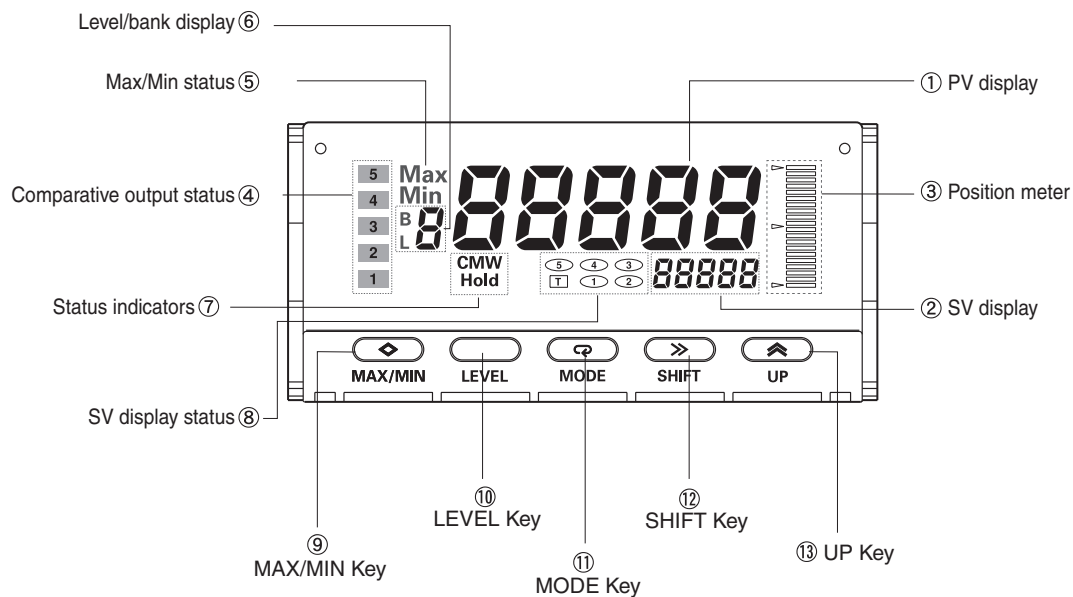

No.	Name	Function
①	PV display	Displays PVs, maximum values, minimum values, parameter names, and error names.
②	SV display	Displays SVs and monitor values.
③	Position meter	Displays the position of the PV with respect to a user-set scale.
④	Comparative output status indicators	Display the status of comparative outputs.
⑤	Max/Min status indicator	Turns ON when the maximum value or minimum value is displayed in RUN level.
⑥	Level/bank display	In RUN level, displays the bank if the bank function is ON. (Turns OFF if the bank function is OFF.) In other levels, displays the current level.
⑦	Status indicators	Hold: Turns ON/OFF when the hold input turns ON/OFF. CMW: Turns ON when communications writing is ON (enabled) and OFF when communications writing is OFF (prohibited).
⑧	SV display status indicators	T: Turns ON when a parameter for which teaching can be performed is displayed. 5, 4, 3, 2, or 1: Turns ON when the comparative values 5, 4, 3, 2, or 1 is displayed in the RUN level.
⑨	MAX/MIN Key	Used to switch the display between the PV, maximum value, and minimum value and to reset the PV, maximum value, and minimum value.
⑩	LEVEL Key	Used to switch the level.
⑪	MODE Key	Used to switch the displayed parameter.
⑫	SHIFT Key	Used to change parameter settings. When changing a set value, this key is used to move along the digits.
⑬	UP Key	When changing a set value, this key is used to change the actual value. When a measurement value is displayed, this key is used to execute teaching.

# 1.4 Internal Block Diagram

Outline

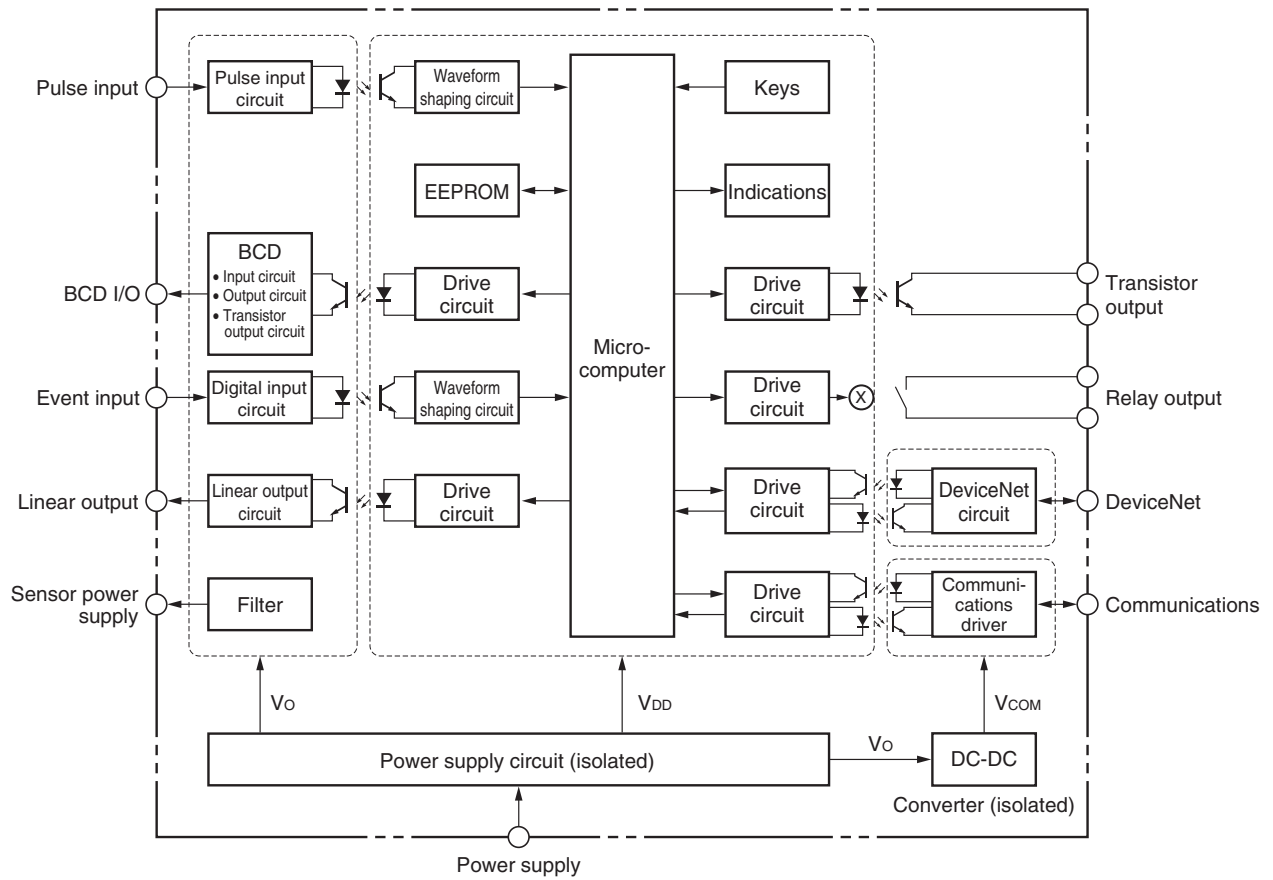





# Section 2 Preparations

2.1 Mounting .....	2-2
2.2 Using I/O .....	2-4

## 2.1 Mounting

### External Dimensions

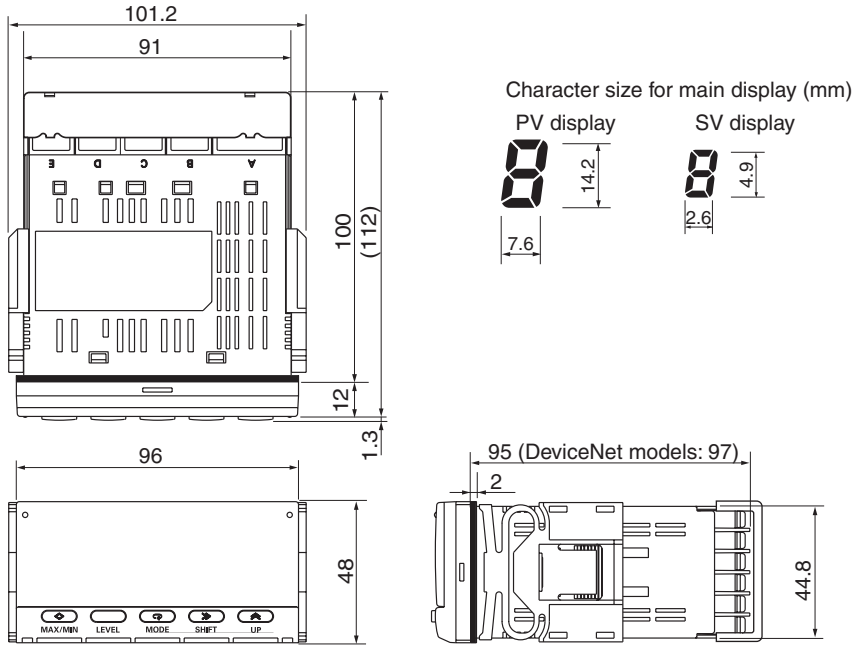

### Panel Cutout Dimensions

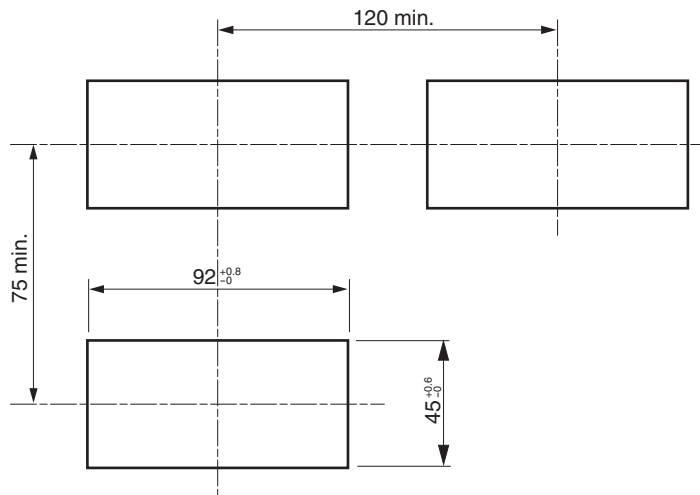

## ■ Mounting Method

- (1) Insert the K3HB into the mounting cutout in the panel.
- (2) Insert watertight packing around the Unit to make the mounting watertight.

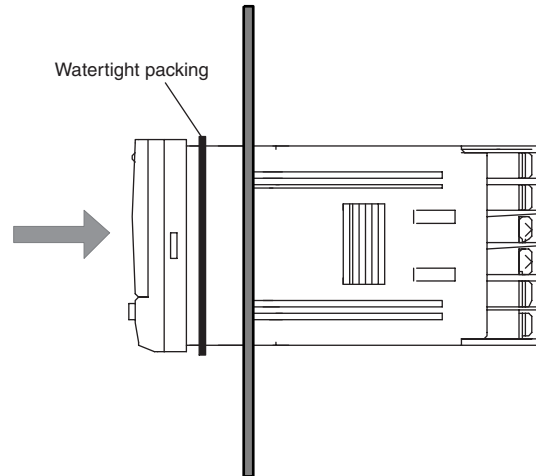

- (3) Insert the adapter into the grooves on the left and right sides of the rear case and push until it reaches the panel and is fixed in place.

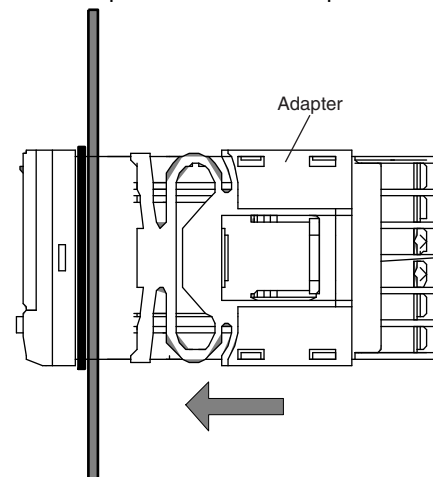

## ■ LCD Field of Vision

The K3HB is designed to have the best visibility at the angles shown in the following diagram.

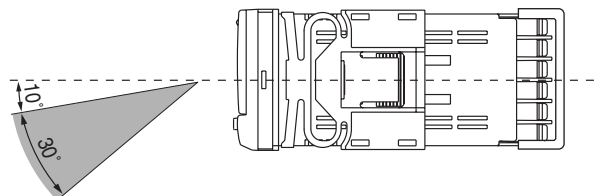

# 2.2 Using I/O

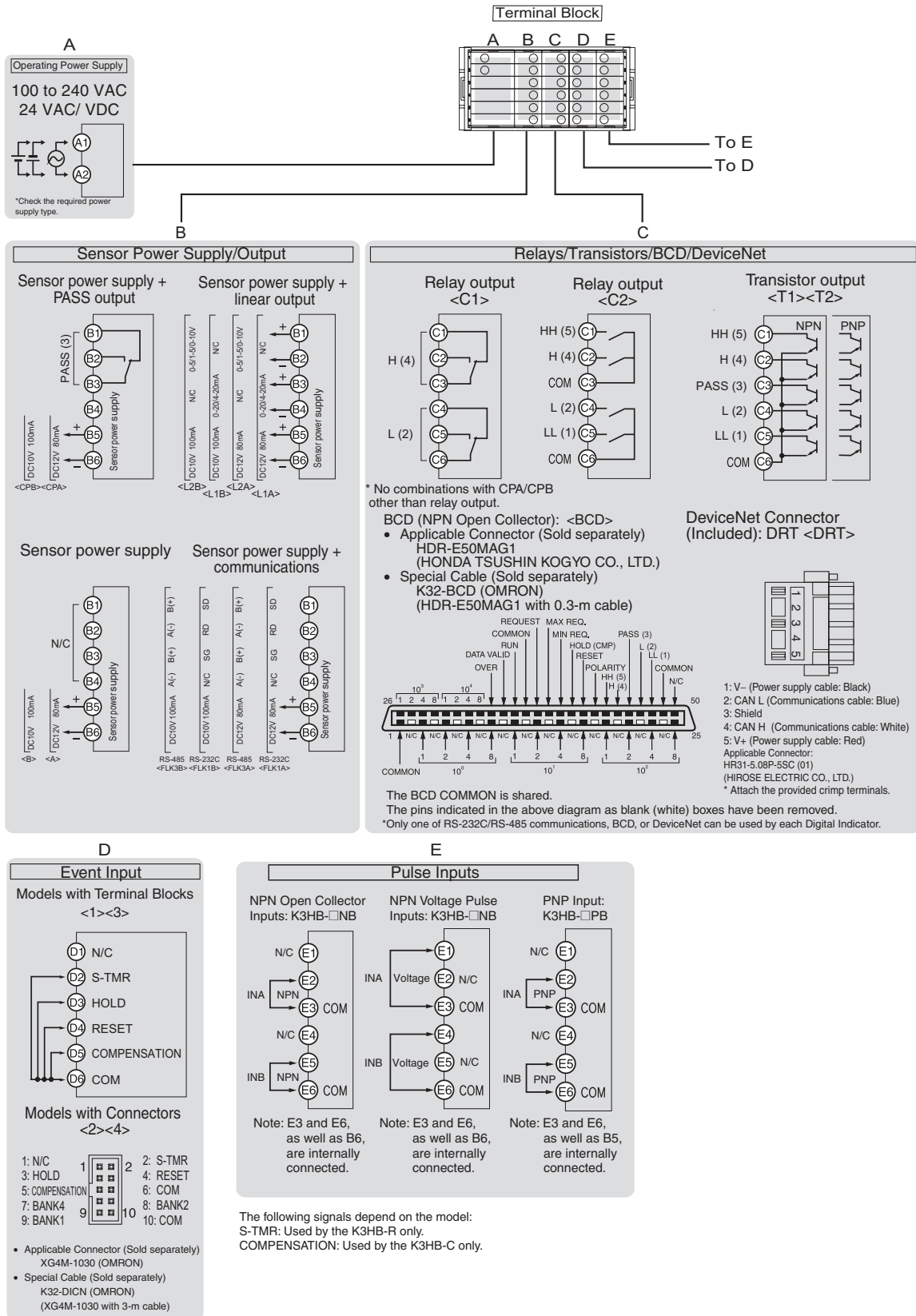

## ■ Wiring

Use crimp terminals suitable for M3 screws, as shown below.

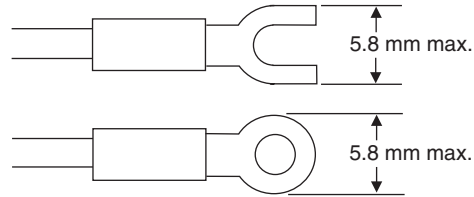

Use cables with a heat resistance of at least 70°C.

### ● Power Supply



Supply power to terminal numbers A1 and A2. The power supply specifications are outlined below.

100 to 240 VAC, 50/60 Hz, 18 VA max. (at max. load)

24 VAC/VDC, 50/60 Hz, 12 VA max./7 W max. (at max. load)

(No polarity)

When the power is turned ON, a power supply capacity greater than the rated power supply is required. When multiple Units are being used, make sure that the operating power supply has sufficient capacity.

#### Complying with UL/CSA Standards

Use an SELV power supply with overcurrent protection for the DC power supply. An SELV power supply has double or reinforced insulation between the input and output, an output voltage of 30 V rms and 42.4 V peak, and is 60 VDC or less.

Recommended Power Supply: S8VS-06024□ (from OMRON)

### ● Sensor Power Supply

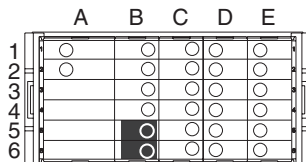

The sensor power can be supplied from terminals B5 and B6. The power supply specifications are outlined below.

12 VDC 80 mA      ⓅB5 → +

or

10 VDC 100 mA      ⓅB6 → -

Refer to page A-6 for information on the derating curve for the Sensor power supply.

● Linear Outputs

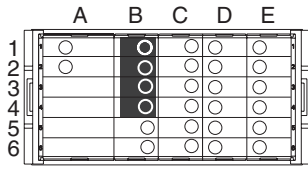

Linear currents and voltages are output between terminals B1 to B2 and between B3 to B4.

Connect a load within the specified range.

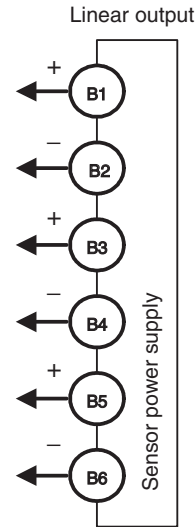

**Note:** Terminals B2 and B4 and terminals B2 and B6 are internally connected. If they are connected to a host device with a shared common, an unwanted current path may be created, preventing the correct signals from being output. If that occurs, provide isolation with a signal converter (an isolator) or other method.

Circuit Diagrams

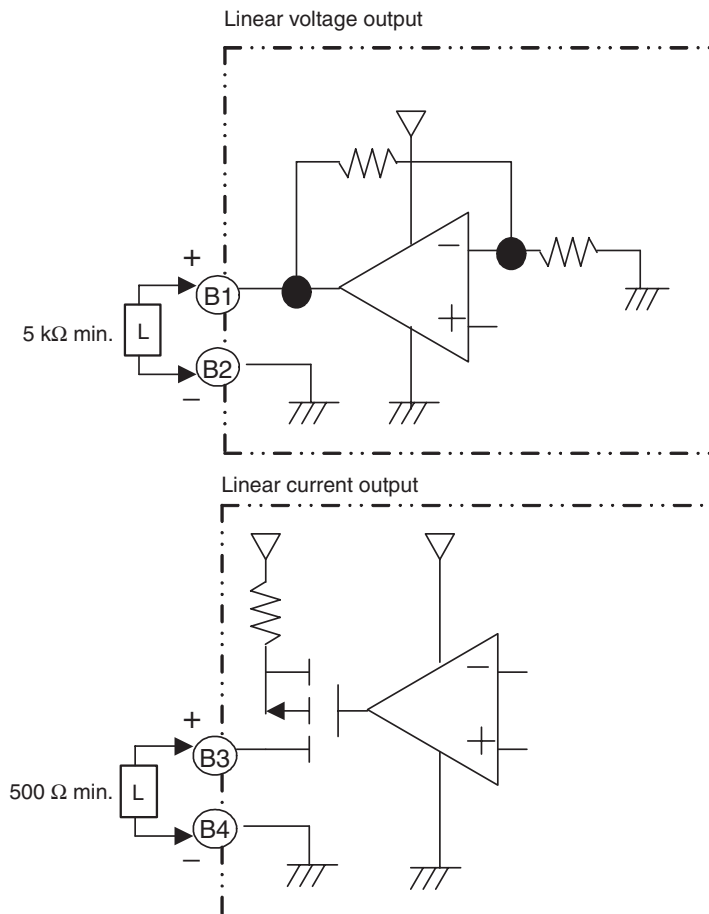

## ● Comparative Outputs

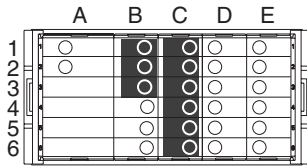

Comparative outputs are output to terminals B1 to B3 and C1 to C6.

Connect loads within specifications.

The electrical life expectancy of the relays is 100,000 operations.

K3HB-C outputs are enclosed in parentheses (OUT\*).

### Circuit Diagrams

#### Contact Outputs

#### <K34-C1> H (OUT4) and L (OUT2) Output Models

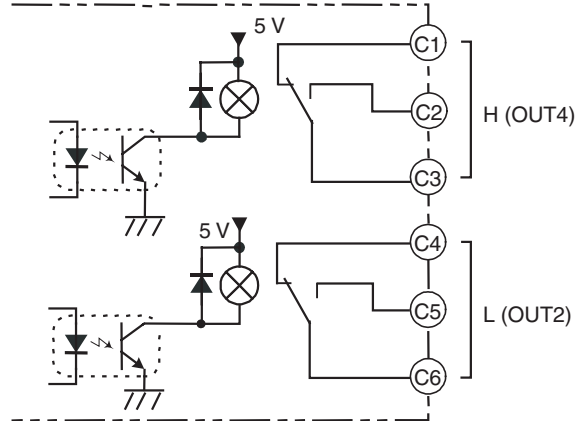

#### <K34-C2> HH (OUT5), H (OUT4), L (OUT2), and LL (OUT1) Output Models

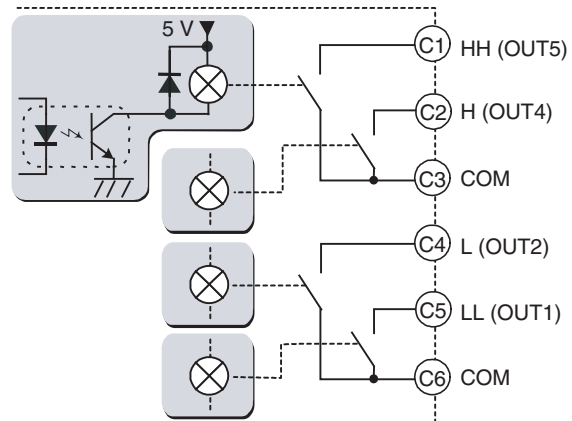

#### <K34-CPA> PASS (OUT3) Output Models

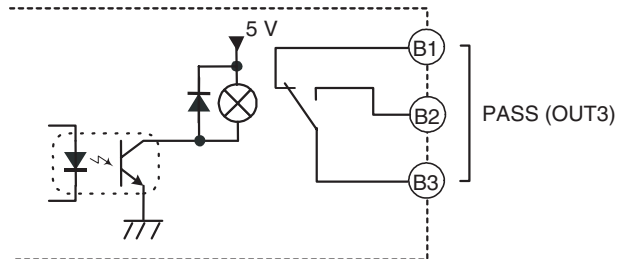

Transistor Outputs

<K34-T1> NPN Output Models

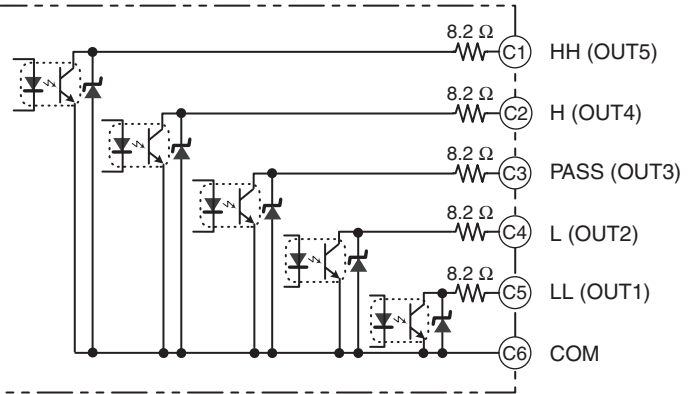

<K34-T2> PNP Output Models

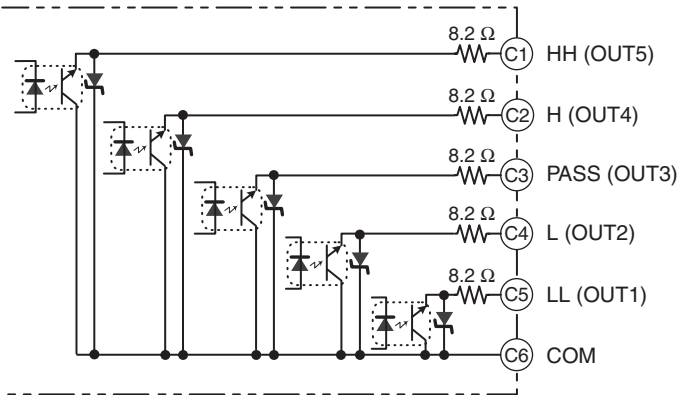



● Event Inputs

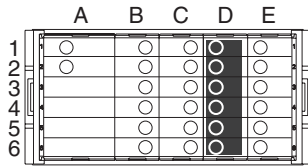

Input control signals. The configuration is shown below.

S-TMR	Delays measurement until set time expires.	See page 5-35.
HOLD	Holds measurement value, maximum value, minimum value, and output status.	See page 5-49.
RESET	Clears maximum value, minimum value, and output status.	See page 5-34.
COMPENSATION	Sets a compensation value for the measurement value.	See page 5-62.

Models with terminal blocks  
<K35-1><K35-3>

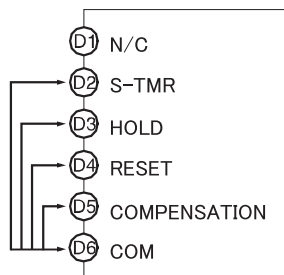

Models with connectors  
<K35-2><K35-4>

- 1: N/C
- 2: S-TMR
- 3: HOLD
- 4: RESET
- 5: COMPENSATION
- 6: COM
- 7: BANK4
- 8: BANK2
- 9: BANK1
- 10: COM

Applicable connector:  
XG4M-1030 (OMRON)

Circuit Diagrams

<K35-1><K35-2> NPN Input Models

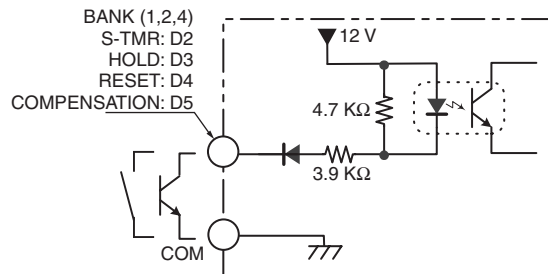

<K35-3><K35-4> PNP Input Models

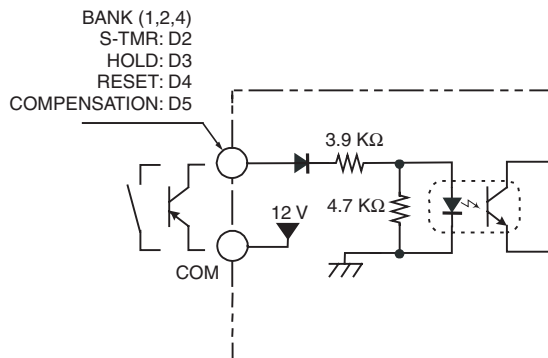

● Pulse Inputs

	A	B	C	D	E
1	○	○	○	○	○
2	○	○	○	○	●
3	○	○	○	○	○
4	○	○	○	○	○
5	○	○	○	○	○
6	○	○	○	○	●

Open Collector Inputs

Input the signals to be measured. The following diagram shows the inputs capable of being measured by each model.

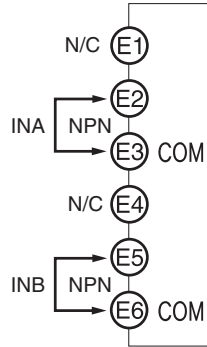

**Note:** E3 and E6, as well as B6 are internally connected.

Circuit Diagram

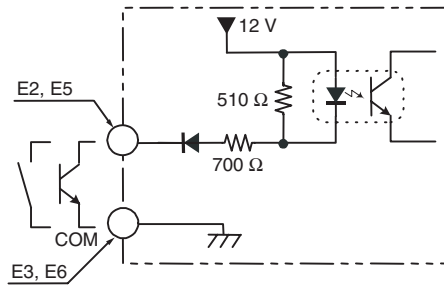

	A	B	C	D	E
1	○	○	○	○	●
2	○	○	○	○	○
3		○	○	○	○
4		○	○	○	○
5		○	○	○	○
6		○	○	○	○

### Voltage Pulse Inputs

Input the signals to be measured. The following diagram shows the inputs capable of being measured by each model.

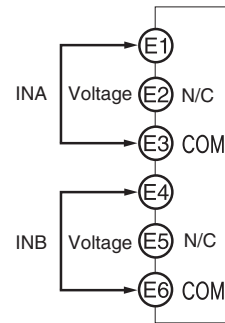

**Note:** E3 and E6, as well as B6 are internally connected.

### Circuit Diagram

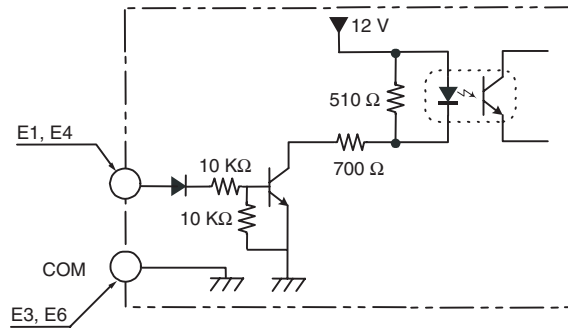

	A	B	C	D	E
1	○	○	○	○	○
2	○	○	○	○	●
3	○	○	○	○	○
4	○	○	○	○	○
5	○	○	○	○	○
6	○	○	○	○	○

### PNP Inputs

Input the signals to be measured. The following diagram shows the inputs capable of being measured by each model.

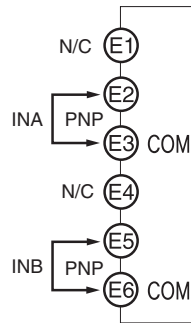

**Note:** E3 and E6, as well as B5 are internally connected.

### Circuit Diagram

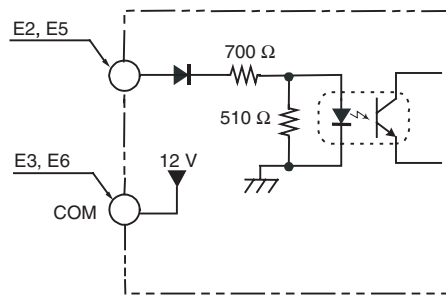

# Section 3 *Basic Application Methods*

3.1	Monitoring Roller Speed: K3HB-R .....	3-2
3.2	Monitoring Conveyor Speed Difference: K3HB-R .....	3-4
3.3	Monitoring Conveyor Line Passing Time: K3HB-R .....	3-7
3.4	Measuring the Operation Time of a Press: K3HB-P .....	3-9
3.5	Measuring Workpiece Passing Time between Points A and B: K3HB-P .....	3-11
3.6	Measuring the Feed Length of a Sheet: K3HB-C .....	3-13
3.7	Counting the Number of Workpieces: K3HB-C .....	3-15

### 3.1 Monitoring Roller Speed: K3HB-R

#### Advantages of Using the K3HB-R

- Monitors roller speed by using a proximity sensor to detect the teeth on a gear attached to the end of the roller.
- Outputs four comparison levels corresponding to the roller speed: LL, L, H, and HH.

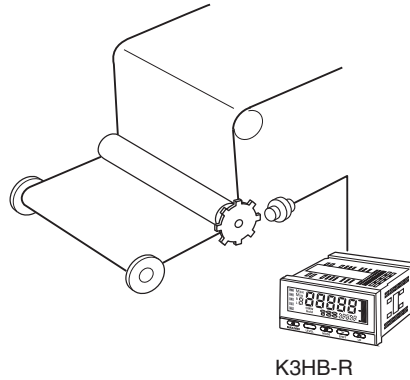

#### Setting the Prescale Value

Prescale value ( $\alpha$ ) =  $1/8 = 0.125 = 0.125 \times 10^0$

Input A prescale value X (mantissa):  $P59\bar{U} = 0.1250$

Input A prescale value Y (exponent):  $P59Y = 10\ 00$

#### Connections Diagram

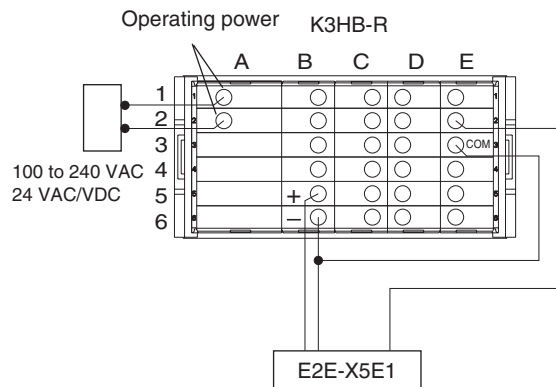

#### Standard Outputs

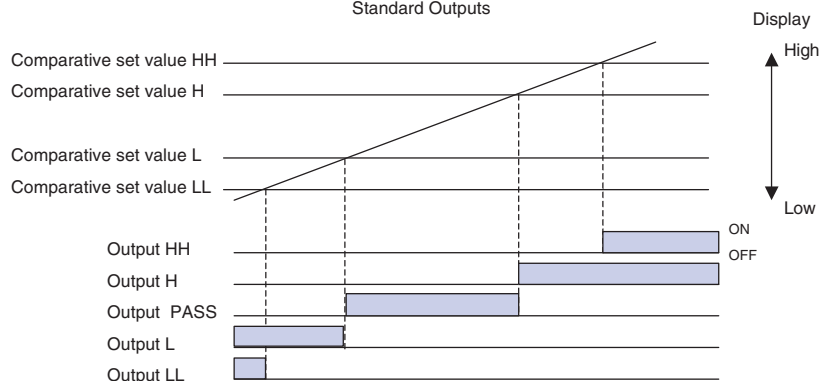

## ■ Settings for the K3HB-R

### RUN Level

Parameter	Characters	Set value	Remarks
Comparative set value HH	*	3400	Control example for the following settings: HH alarm: 3,400 rpm H alarm: 3,200 rpm L alarm: 800 rpm LL alarm: 400 rpm
Comparative set value H	*	3200	
Comparative set value L	*	800	
Comparative set value LL	*	400	

\* Check on the status displays.

### Initial Setting Level (L 0)

Parameter	Characters	Set value	Remarks
Function	FUN $\bar{L}$	F1	Rpm/circumferential speed
Input type A	IN- $\bar{A}$	00	No-contact (NO)
Prescale AX	PS. $\bar{A}\bar{X}$	0.1250	Prescale value ( $\alpha$ ) = 1/8 = 0.125 = 0.125 × 10 <sup>0</sup>
Prescale AY	PS. $\bar{A}\bar{Y}$	10 00	
Decimal point position	dP	000000	No decimal point
Comparative output pattern	OUT-P	000000	Standard outputs

### Input Adjustment Level (L 1)

Parameter	Characters	Set value	Remarks
Averaging type	AVG- $\bar{t}$	5 $\bar{n}$ P $\bar{L}$	Simple averaging
Averaging times	AVG-n	1	Once
Auto-zero time A	AE. $\bar{Z}\bar{A}$	10.0	Display is forced to zero when no pulse is received for 10 seconds.

### Display Adjustment Level (L 2)

Parameter	Characters	Set value	Remarks
Display value selection	d $\bar{L}$ S $\bar{P}$	P $\bar{u}$	Present value
Position meter type	P $\bar{O}$ S- $\bar{t}$	IN $\bar{L}$	Incremental display
Position meter upper limit	P $\bar{O}$ S- $\bar{H}$	3400	Full-scale 400 to 3,400 mm
Position meter lower limit	P $\bar{O}$ S- $\bar{L}$	400	

## 3.2 Monitoring Conveyor Speed Difference: K3HB-R

### Advantages of Using the K3HB-R

- Monitors differences in the speeds of conveyors using two 60-pulse/rotation NPN open collector rotary encoders.
- Outputs four comparison levels corresponding to the conveyor speed: LL, L, H, and HH.
- A green display indicates operation within the correct range, and a red display indicates operation not within the correct range.

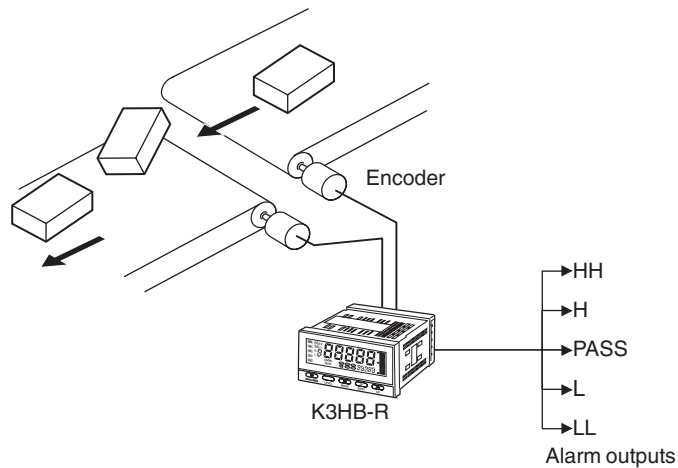

Connections Diagram

K3HB-R

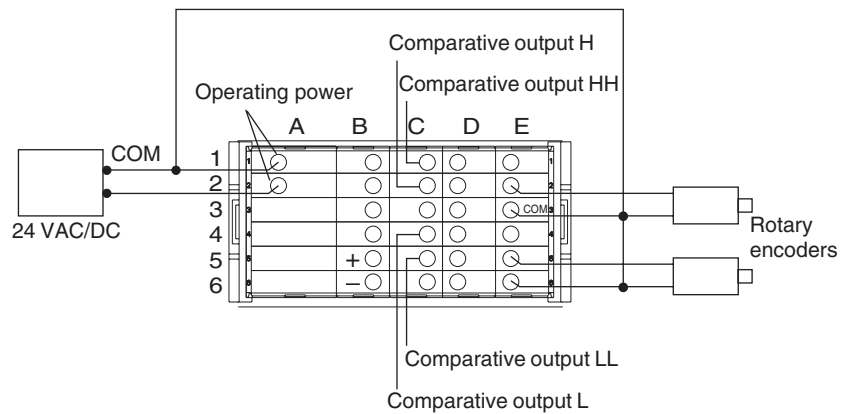

Standard Outputs

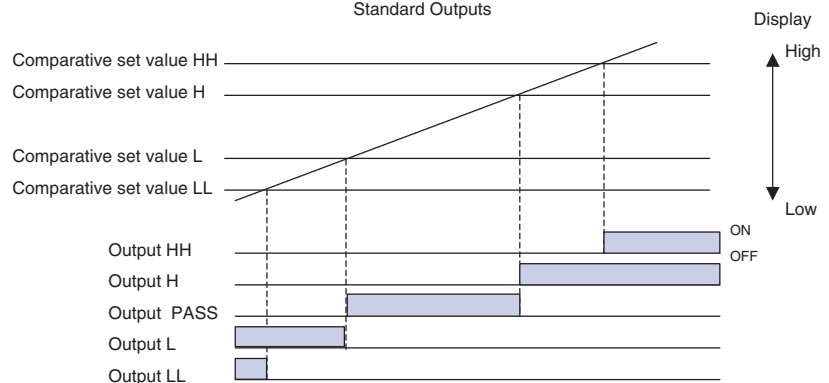



## ■ Settings for the K3HB-R

### RUN Level

Parameter	Characters	Set value	Remarks
Comparative set value HH	*	100	Control example for the following settings: HH alarm: 100 rpm H alarm: 50 rpm L alarm: -50 rpm LL alarm: -100 rpm
Comparative set value H	*	50	
Comparative set value L	*	-50	
Comparative set value LL	*	-100	

\* Check on the status displays.

### Initial Setting Level (L 0)

Parameter	Characters	Set value	Remarks
Function	FUN	F4	Rotational difference
Input type A	IN-AR	00	No-contact (NO)
Input type B	IN-AB	00	No-contact (NO)
Prescale AX	PS.AX	1.666	Input A prescale value ( $\alpha$ ) = $1/60 = 0.01666... \approx$ $1.666 \dots \times 10^{-2}$
Prescale AY	PS.AY	10 -2	
Prescale BX	PS.BX	1.666	Input B prescale value ( $\alpha$ ) = $1/60 = 0.01666... \approx$ $1.666 \dots \times 10^{-2}$
Prescale BY	PS.BY	10 -2	
Decimal point position	DP	000000	No decimal point
Comparative output pattern	OUT-P	NONAL	Standard outputs

### Input Adjustment Level (L 1)

Parameter	Characters	Set value	Remarks
Averaging type	AUG-t	SNPL	Simple averaging
Averaging times	AUG-n	1	Once
Auto-zero time A	AZ.A	10.0	Display is forced to zero when no pulse is received for 10 seconds.
Auto-zero time B	AZ.B	10.0	

### Display Adjustment Level (L2)

Parameter	Characters	Set value	Remarks
Display color selection	Color	Green-r	PASS range: Green, LL, L, H, and HH ranges: Red
Display value selection	display	Pv	Present value
Position meter type	Pass-t	dev	Deviation display
Position meter upper limit	Pass-H	100	Full-scale -100 to 100 rpm
Position meter lower limit	Pass-L	- 100	

## 3.3 Monitoring Conveyor Line Passing Time: K3HB-R

### Advantages of Using the K3HB-R

- Displays the passing time to tenths of a second (00.0 s) using a rotary encoder that outputs 100 pulses/rotation.
- The prescale value is obtained using the following formula, assuming a roller circumference ( $\pi d$ ) of 0.125 m and processing length of 5 m.

$$\text{Rpm} = \text{Input frequency} \times \frac{1}{\text{Pulses (N) per rotation}}$$

$$\text{Circumferential speed} = \text{Roller circumference } (\pi d) \times \text{rotational speed}$$

$$\text{Passing time} = \frac{\text{Processing length}}{\text{Circumferential speed}}$$

$$\text{Scaling value} = \frac{\text{Processing length (m)}}{\text{Circumferential length per rotation/pulses per rotation}}$$

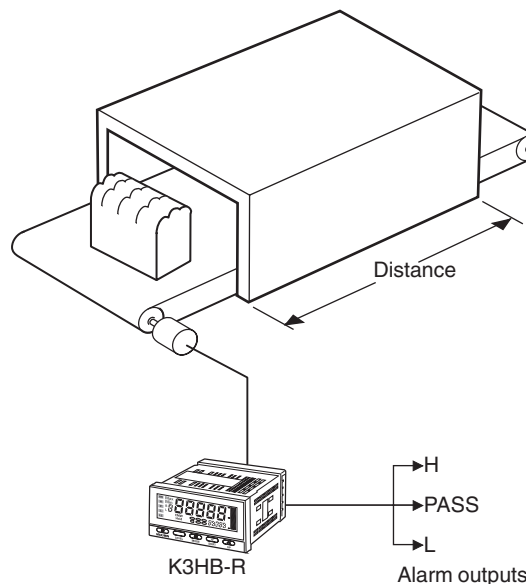

### Connections Diagram

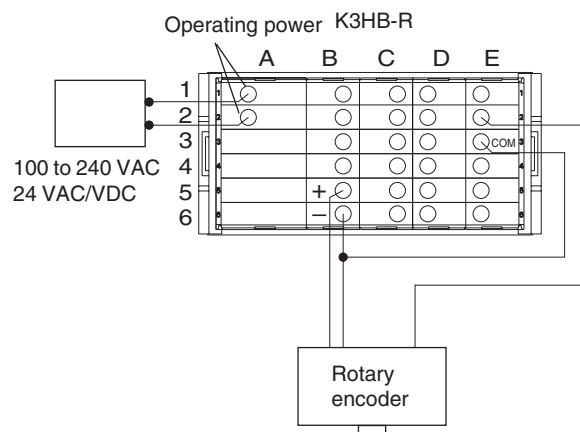

## ■ Settings for the K3HB-R

### RUN Level

Parameter	Characters	Set value	Remarks
Comparative set value H	*	50.0	
Comparative set value L	*	10.0	

\* Check on the status displays.

### Initial Setting Level (L 0)

Parameter	Characters	Set value	Remarks
Function	FUNC	F6	Passing time
Input type A	IN-TR	00	No-contact (NO)
Prescale AX	PS.AX	4.0000	Prescale value ( $\alpha$ ) = 5/ (0.125/100) = 4000 = $4.0000 \times 10^3$
Prescale AY	PS.AY	10 03	
Time unit	TIME	OFF	Disabled
Decimal point position	DP	0000.0	One digit below the decimal point
Comparative output pattern	OUT-P	NONAL	Standard outputs

### Input Adjustment Level (L 1)

Parameter	Characters	Set value	Remarks
Averaging type	AUC-t	SNPL	Simple averaging
Averaging times	AUC-n	1	Once

### Display Adjustment Level (L 2)

Parameter	Characters	Set value	Remarks
Display value selection	DISP	PU	Present value
Position meter type	POS-t	INC	Incremental display
Position meter upper limit	POS-H	999	Full-scale 0.0 to 99.9 s
Position meter lower limit	POS-L	0	

## 3.4 Measuring the Operation Time of a Press: K3HB-P

### Advantages of using the K3HB-P

- Sensor ON time is measured using a through-beam photoelectric sensor.
- Displays the measurement value to tenths of a second (00.0 s) with the display unit of the K3HB-P set to seconds.

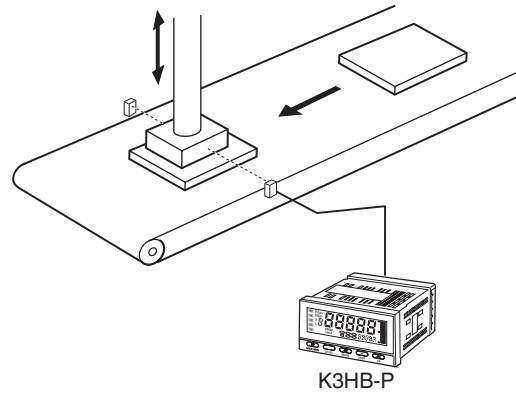

Connections Diagram

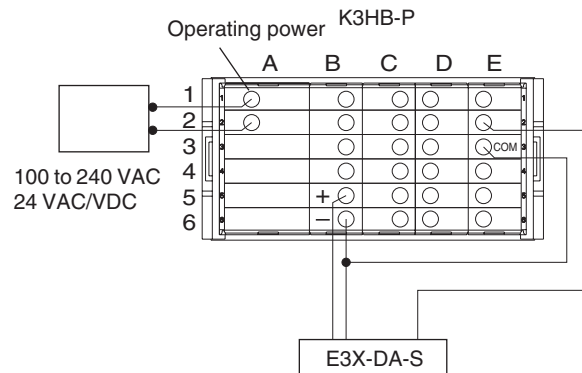

Standard Outputs

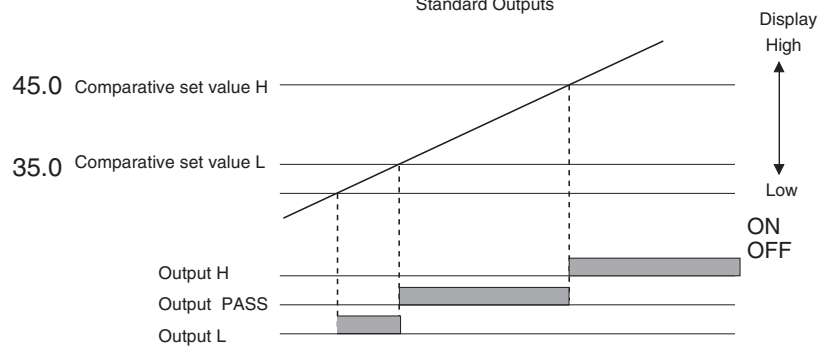

## ■ Settings for the K3HB-P

### RUN Level

Parameter	Characters	Set value	Remarks
Comparative set value H	*	45.0	
Comparative set value L	*	35.0	

\* Check on the status displays.

### Initial Setting Level (L 0)

Parameter	Characters	Set value	Remarks
Function	FUNC	F4	Time band
Input type A	IN-TR	00	No-contact (NO)
Prescale AX	PS.AX	1.0000	Prescale value ( $\alpha$ ) = 1 = $1.0000 \times 10^0$
Prescale AY	PS.AY	10 00	
Decimal point position	dP	0000.0	One digit below the decimal point
Comparative output pattern	OUT-P	NONAL	Standard outputs

### Display Adjustment Level

(L 2)

Parameter	Characters	Set value	Remarks
Display value selection	dLSP	PU	Present value
Position meter type	POS-T	INC	Incremental display
Position meter upper limit	POS-H	999	Full-scale 0.0 to 99.9 s
Position meter lower limit	POS-L	0	

## 3.5 Measuring Workpiece Passing Time between Points A and B: K3HB-P

### Advantages of Using the K3HB-P

- Measures the time from when sensor A turns ON until sensor B turns ON.
- Displays the measurement value to tenths of a second (00.0 s) with the display unit of the K3HB-P set to seconds.

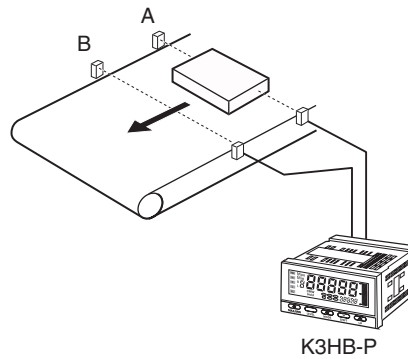

### Connections Diagram

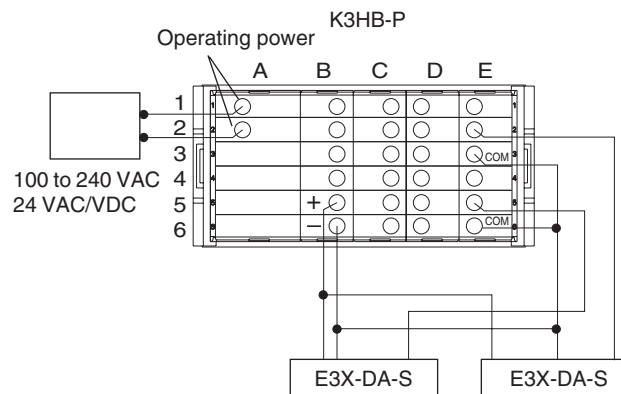

## ■ Setting for the K3HB-P

### RUN Level

Parameter	Characters	Set value	Remarks
Comparative set value H	*	45.0	
Comparative set value L	*	35.0	

\* Check on the status displays.

### Initial Setting Level (L 1)

Parameter	Characters	Set value	Remarks
Function	FunL	F3	Time difference
Input type A	In-tA	00	No-contact (NO)
Input type B	In-tB	00	No-contact (NO)
Prescale AX	PS.AX	1.0000	Prescale value ( $\alpha$ ) = 1 = $1.0000 \times 10^0$
Prescale AY	PS.AY	10 00	
Decimal point position	dP	0000.0	One digit below the decimal point
Comparative output pattern	Out-P	noRL	Standard outputs

### Display Adjustment Level (L 2)

Parameter	Characters	Set value	Remarks
Display value selection	dSP	Pu	Present value
Position meter type	Pos-t	InL	Incremental display
Position meter upper limit	Pos-H	999	Full-scale 0.0 to 99.9 s
Position meter lower limit	Pos-L	0	



## 3.6 Measuring the Feed Length of a Sheet: K3HB-C

### Advantages of using the K3HB-C

- Displays the measurement value to tenths of a millimeter (0000.0 mm) using a rotary encoder that outputs 250 pulses to measure a feed length of 0.5 m.
- Outputs comparative output OUT1 when the measurement value is 500.0 or higher.
- Outputs comparative output OUT2 when the measurement value is 700.0 or higher.

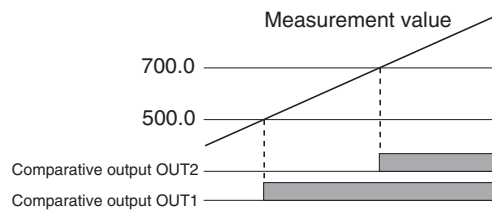
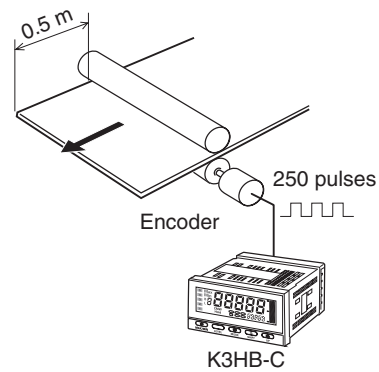

### Connections Diagram

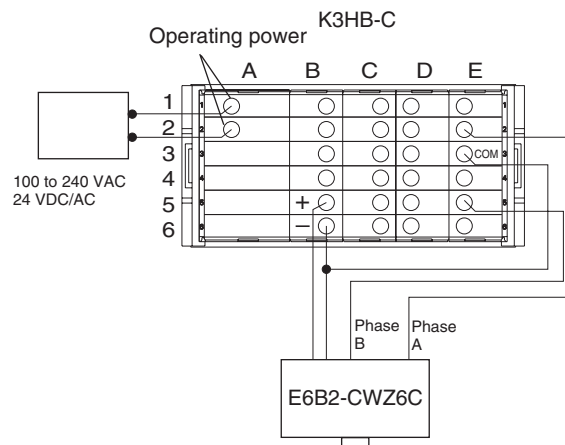

## ■ Setting for the K3HB-C

### RUN Level

Parameter	Characters	Set value	Remarks
Comparative set value OUT1	*	500.0	
Comparative set value LOUT2	*	700.0	

\* Check on the status displays.

### Initial Setting Level (L 0)

Parameter	Characters	Set value	Remarks
Function	FunC	F2	Phase differential inputs
Input type A	In-tA	00	No-contact (NO)
Input type B	In-tB	00	No-contact (NO)
Prescale AX	PS.Ax	2.0000	Prescale value ( $\alpha$ ) = 2 = $2.0000 \times 10^0$
Prescale AY	PS.Ay	10.00	
Decimal point position	dP	0000.0	One digit below the decimal point
Comparative output pattern	Out-P	LEUL	Level outputs

### Display Adjustment Level (L 2)

Parameter	Characters	Set value	Remarks
Display value selection	dSP	Pu	Present value
Position meter type	PS-t	InC	Incremental display
Position meter upper limit	PS-H	10000	Full-scale 0.0 to 1000.0 mm
Position meter lower limit	PS-L	0	

## 3.7 Counting the Number of Workpieces: K3HB-C

### Advantages of Using the K3HB-C

- Detects and counts workpieces on a conveyor.
- Using the prescale value banks, two units can be counted as a single workpiece, 4 units can be counted as a single workpiece, etc.
- Remembers the measurement value immediately preceding a power interruption.
- Using a BCD output, the count is displayed on the M7E.

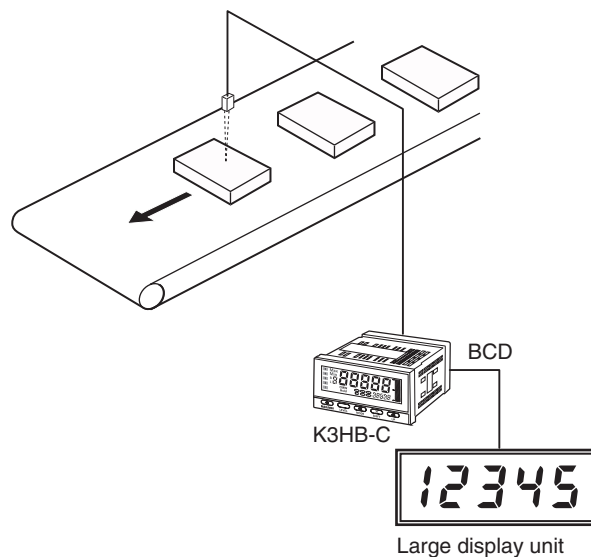

### Connections Diagram

#### Note

Use the K32-BCD Cable (purchased separately) for BCD output wiring. Refer to the K3HB Digital Indicators Communications User's Manual (N129) for details on the wiring method of the M7E.

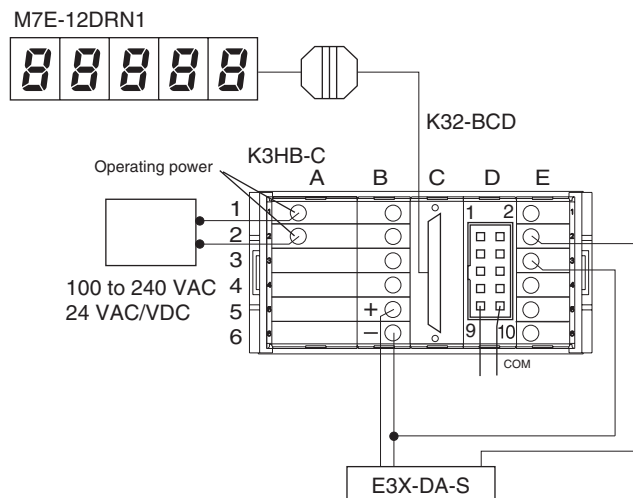

## ■ Settings for the K3HB-C

### Advanced Function Setting Level (L F)

Parameter	Characters	Set value	Remarks
Bank selection	b n P - E	E U	Event inputs

\*The Setting Level Protect parameter (SEt.Pt) must be set to 0 (0), and the Move to Advanced Function Setting Level parameter (Rnāw) to -0169 (-0 169) to enable moving to the advanced function setting level.

### Initial Setting Level (L G)

Parameter	Characters	Set value	Remarks
Function	F U n E	F 3	Pulse counting input
Input type A	l n - t R	0 0	No-contact (NO)
Comparative output pattern	ā U t - P	ā ā n E	Zone output

### Input Adjustment Level (L I)

Parameter	Characters	Set value	Remarks
Interruption memory	n E n ā	ā n	Interruption memory ON

### Display Adjustment Level (L J)

Parameter	Characters	Set value	Remarks
Display value selection	d l S P	P U	Present value

### Prescale Level (L K)

Parameter	Character s	Set value	Remarks
Prescaling bank	P S. b n P	0, 1	Settings for prescale 0 prescale 1 (See note.)
Prescale 0AX	P S 0. A X	0. 5000	To display two units as one workpiece, the prescale = $1/2 = 0.5 = 0.5000 \times 10^0$
Prescale 0AY	P S 0. A Y	10 00	
Prescale 0 decimal position	d P 0	000000	No decimal point
Prescale 1AX	P S 1. A X	0. 2500	To display four units as one workpiece, the prescale = $1/4 = 0.25 = 0.2500 \times 10^0$
Prescale 1AY	P S 1. A Y	10 00	
Prescale 1 decimal position	d P 1	000000	No decimal point

Note When prescale bank 0 is set, the prescale 0 settings are performed next.

### Comparative Set Value Level (L 4)

Parameter	Characters	Set value	Remarks
Comparative set value banks (See note.)	Sw.bank	1, 2	Bank 0 or bank 1
Comparative set value 0 OUT1	Sw.0.01	100	
Comparative set value 1 OUT1	Sw.1.01	100	

Note When comparative set value bank 0 is set, the comparative set value 0 OUT5 settings are performed next.



# Section 4 Initial Setup

4.1 Initial Setup Example for the K3HB-R.....	4-2
4.2 Initial Setup Example for the K3HB-P.....	4-4
4.3 Initial Setup Example for the K3HB-C.....	4-6

## 4.1 Initial Setup Example for the K3HB-R

The initial setup is explained in the following example.

### Settings Example

- A proximity sensor that outputs eight pulses per rotation is used to detect the teeth on a gear and the rotation speed of the roller is displayed in rpm.
- If the measurement value goes above 700 rpm, comparative output H turns ON.
- If the measurement value goes below 500 rpm, comparative output L turns ON.

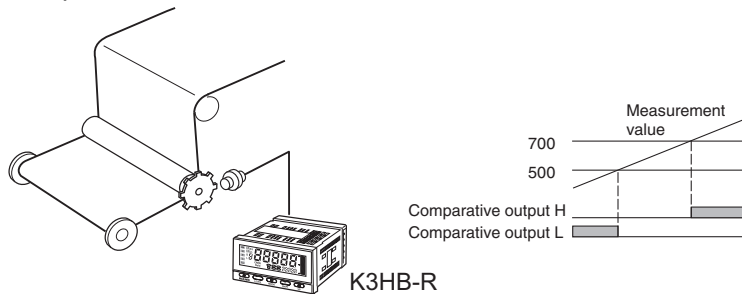

### Setting the Prescale Value

Prescale value ( $\alpha$ ) =  $1/8 = 0.125 = 0.125 \times 10^{-0}$

Prescale value of Input A, X (mantissa): *PS.R0 = 0.1250*

Prescale value of Input A, Y (exponent): *PS.R4 = 10 00*

### Initial Setup Flow

● To change a set value, press the [SHIFT] Key once to enable changing the setting and then press the [UP] Key to change the value.

Press the [MODE] Key to register the set value. The set value will be registered and the next parameter will be displayed.

**A** Check the wiring and turn the power ON.

- The display will show "0".

**B** Set the function to F1 (rpm/circumferential speed).



1. Move to the initial setting level by pressing the [LEVEL] Key for at least 3 s (operation will stop).
2. Set "F1" to "F 1" and press the [MODE] Key.

**C** Set input type A to 00 (no-contact, normally open).

1. Set input type A "00" to "00" and press the [MODE] Key.





**D** Set the prescale value.

1. Set the prescale AX "P5. A $\bar{X}$ " to "0 1250" and press the  [MODE] Key.
2. Set the prescale AY "P5. A $\bar{Y}$ " to "10 00" and press the  [MODE] Key.

**E** Set the decimal point position.

1. Set the decimal point position "dP" to "00000" (default value) and press the  [MODE] Key.

**F** Set comparative set value H to 700 and set comparative set value L to 500.

1. Return to the RUN level by pressing the  [LEVEL] Key for at least 1 s. (Start operation.)
2. Press the  [MODE] Key several times to change the SV display status to "H" and set the value to "00700".
3. Press the  [MODE] Key several times to change the SV display status to "L" and set the value to "00500".

**G** Start actual operation.

1. Press the  [MODE] Key several times to display the measurement values and start actual operation.

**Clearing Settings**

If you become confused while setting the parameters and cannot continue, all settings can be cleared so that you can start over.

Refer to "5.33 Initializing All Settings" (P.5-84) for information on clearing all settings.

\* Refer to "Section 5 Functions and Operations" for details on setting parameters.

## 4.2 Initial Setup Example for the K3HB-P

The initial setup is explained in the following example.

### Settings Example

The passing speed is displayed in m/s when the distance between A and B is 5 m.

- If the measurement value goes above 0.700, comparative output H turns ON.
- If the measurement value goes below 0.500, comparative output L turns ON.

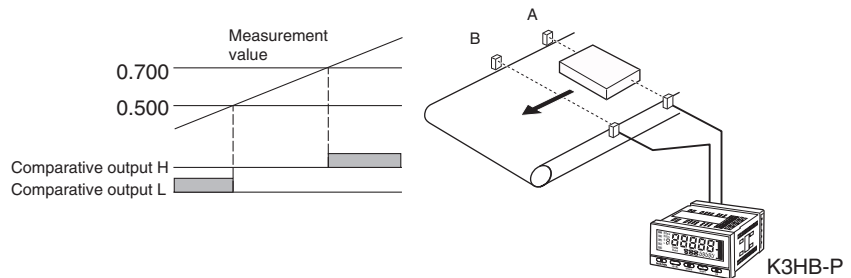

### Setting the Prescale Value

The prescale value can be obtained using the following formula when the output is to be displayed in m/s.

$$\text{Prescale value } (\alpha) = 5/60 = 0.08333 \dots = 8.3333 \times 10^{-2}$$

Prescale value of Input A, X (mantissa): **PS. R0 = 8.3333**

Prescale value of Input B, Y (exponent): **PS. R4 = 10 -2**

### Initial Setup Flow

● To change a set value, press the [SHIFT] Key once to enable changing the setting and then press the [UP] Key to change the value.

Press the [MODE] Key to register the set value. The set value will be registered and the next parameter will be displayed.

**A** Check the wiring and turn the power ON.

- The display will show "-----".



**B** Set the function to F1 (passing speed).

1. Move to the initial setting level by pressing the [LEVEL] Key for at least 3 s (operation will stop).
2. Set "F1nL" to "F 1" and press the [MODE] Key.

**C** Set input type A and input type B to 00 (no-contact, normally open).

1. Set input type A "0n-1A" to "00" and press the [MODE] Key.
2. Set input type B "0n-1B" to "00" and press the [MODE] Key.



**D Set the prescale value.**

1. Set the prescale AX "P5.  $\overline{A}$ " to "8. 3333" and press the  [MODE] Key.
2. Set the prescale AY "P5.  $\overline{B}$ " to "10 -2" and press the  [MODE] Key.

**E Set the decimal point position.**

1. Set the decimal point position "dP" to "00. 000" (default value) and press the  [MODE] Key.

**F Set comparative set value H to 0.700 and set comparative set value L to 0.500.**

1. Return to the RUN level by pressing the  [LEVEL] Key for at least 1 s. (Start operation.)
2. Press the  [MODE] Key several times to change the SV display status to "H" and set the value to "0. 700".
3. Press the  [MODE] Key several times to change the SV display status to "L" and set the value to "0. 500".

**G Start actual operation.**

1. Press the  [MODE] Key several times to display the measurement values and start actual operation.

**Clearing Settings**

If you become confused while setting the parameters and cannot continue, all settings can be cleared so that you can start over.

Refer to "5.33 Initializing All Settings" (P.5-84) for information on clearing all settings.

\* Refer to "Section 5 Functions and Operations" for details on setting parameters.

## 4.3 Initial Setup Example for the K3HB-C

The initial setup is explained in the following example.

### Settings Example

The feed length is displayed to tenths of a millimeter (0000.0mm) using a rotary encoder that outputs 250 pulses per rotation to measure a feed length of 0.5 m.

- If the measurement value goes above 500.0, comparative output OUT1 turns ON.
- If the measurement value goes below 700.0, comparative output OUT2 turns ON.

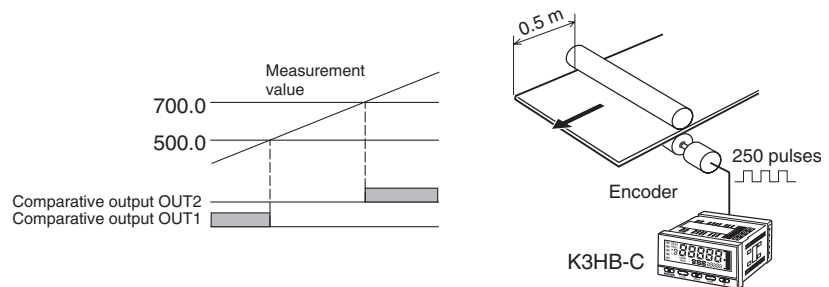

### Setting the Prescale Value

The prescale value can be obtained using the following formula when the output is to be displayed as 0000.0 mm.

$$\text{Prescale value } (\alpha) = 500/250 = 2 \times 10^0$$

Prescale value of Input A, X (mantissa): *PS. R0 = 2.0000*

Prescale value of Input B, Y (exponent): *PS. R4 = 10 00*

### Initial Setup Flow

● To change a set value, press the [SHIFT] Key once to enable changing the setting and then press the [UP] Key to change the value.

Press the [MODE] Key to register the set value. The set value will be registered and the next parameter will be displayed.

#### A Check the wiring and turn the power ON.

- The display will show “0”.

#### B Set the function to F2 (phase differential inputs).

1. Move to the initial setting level by pressing the [LEVEL] Key for at least 3 s (operation will stop).
2. Set “F1nL” to “F2” and press the [MODE] Key.

#### C Set input type A to 00 (no-contact, normally open).

- Set input type A “L n - t R” to “00” and press the [MODE] Key.

**D** Set the prescale value.

1. Set the prescale AX "P5. R $\bar{A}$ " to "2. 0000" and press the  $\square$  [MODE] Key.
2. Set the prescale AY "P5. R $\bar{Y}$ " to "10 00" (default value) and press the  $\square$  [MODE] Key.

**E** Set the decimal point position.

1. Set the decimal point position "dP" to "0000. 0" and press the  $\square$  [MODE] Key.

**F** Set the comparative output pattern.

1. Set the comparative output pattern "OUT-P" to "LEVEL" and press the  $\square$  [MODE] Key.

**G** Set comparative set value OUT1 to 500.0 and set comparative set value OUT2 to 700.0.

1. Return to the RUN level by pressing the  $\square$  [LEVEL] Key for at least 1 s. (Start operation.)
2. Press the  $\square$  [MODE] Key several times to change the SV display status to "2" and set the value to "700. 0".
3. Press the  $\square$  [MODE] Key several times to change the SV display status to "1" and set the value to "500. 0".

**H** Start actual operation.

1. Press the  $\square$  [MODE] Key several times to display the measurement values and start actual operation.

## Clearing Settings

If you become confused while setting the parameters and cannot continue, all settings can be cleared so that you can start over.  
Refer to "5.33 Initializing All Settings" (P.5-84) for information on clearing all settings.

\* Refer to "Section 5 Functions and Operations" for details on setting parameters.



# Section 5 Functions and Operations

Knowledge Required for Setting Parameters.....	5-2
5.1 Setting the Function for the K3HB-R.....	5-9
5.2 Setting the Function for the K3HB-P.....	5-17
5.3 Setting the Function for the K3HB-C.....	5-24
5.4 Setting Input Types.....	5-28
5.5 Setting Prescale Values.....	5-29
5.6 Setting the Auto-zero Time.....	5-32
5.7 Resetting Measurements.....	5-34
5.8 Not Performing Measurements for Set Intervals.....	5-35
5.9 Averaging Input.....	5-37
5.10 Changing Comparative Output Patterns.....	5-40
5.11 Preventing Output Chattering.....	5-43
5.12 Outputting for a Set Interval.....	5-45
5.13 Delaying Output OFF Timing.....	5-47
5.14 Holding Measurement Status.....	5-49
5.15 Holding Comparative Outputs.....	5-50
5.16 Allocating Another Output to PASS Output.....	5-52
5.17 Reversing Output Logic.....	5-54
5.18 No Output before PASS Range.....	5-56
5.19 Performing Linear Output.....	5-58
5.20 Changing the Display Refresh Period.....	5-61
5.21 Setting a Compensation Value for the Measurement Value.....	5-62
5.22 Holding Measurement Values.....	5-64
5.23 Holding Maximum and Minimum Values.....	5-66
5.24 Changing Normal Display Values to Maximum and Minimum Values.....	5-67
5.25 Displaying/Not Displaying Comparative Set Values.....	5-69
5.26 Changing Display Colors.....	5-70
5.27 Using the Position Meter.....	5-72
5.28 Automatic Return to Normal Display.....	5-74
5.29 Performing Output Tests.....	5-75
5.30 Using Prescale/Comparative Set Value Banks.....	5-76
5.31 Copying Bank Prescale Values.....	5-82
5.32 Copying Bank Comparative Set Values.....	5-83
5.33 Initializing All Settings.....	5-84
5.34 Limiting Key Operations.....	5-85

# Knowledge Required for Setting Parameters

## ■ About Levels

Levels are groups of parameters.

Levels for the K3HB are classified as follows:

### Important

Depending on the level, measurements may continue to be executed or may be stopped. Check under the “Measurement operations” column.

Level	Function	Measurement operations
Protect	Makes settings to prevent inadvertent key operations. Movement between levels and changes to settings may be prohibited, depending on the protect settings.	Executed
RUN	The normal operation mode where inputs are read and comparative judgements are made. In RUN level, the present value can be displayed, comparative set values checked, and forced-zero executed or cleared. The K3HB is in RUN mode immediately after the power is turned ON.	
Adjustment	Switches banks and makes settings, such as communications write settings.	
Initial setting	Makes initial settings, such as the input type, scaling, and comparative output patterns.	Stopped
Input adjustment	Adjusts inputs.	
Display adjustment	Enables/disables comparative set value displays, and sets the display refresh periods, display color, and position meter.	
Prescale	Sets the prescale bank.	
Comparative set value	Makes comparative set value bank settings.	
Linear output	Sets the linear output.	
Communications setting	Sets the baud rate, data length, and other communications settings.	
Output test	Sets test measurement values to perform output tests.	
Advanced function settings	Used for advanced customization.	



To change a parameter, move to the level where that parameter is found. The current level is shown on the bank/level display when moving between levels.

Level/bank display	Level
L <sup>P</sup>	Protect level
Not lit or <sup>B</sup> 0 to 7	RUN level (Lights only when banks are used.)
L <sup>A</sup>	Adjustment level
L <sup>0</sup>	Initial setting level
L <sup>1</sup>	Input adjustment level
L <sup>2</sup>	Display adjustment level
L <sup>3</sup>	Prescale level
L <sup>4</sup>	Comparative set value level
L <sup>5</sup>	Linear output level
L <sup>6</sup>	Communications setting level
L <sup>t</sup>	Output test level
L <sup>F</sup>	Advanced function setting level

## ■ Moving between Levels

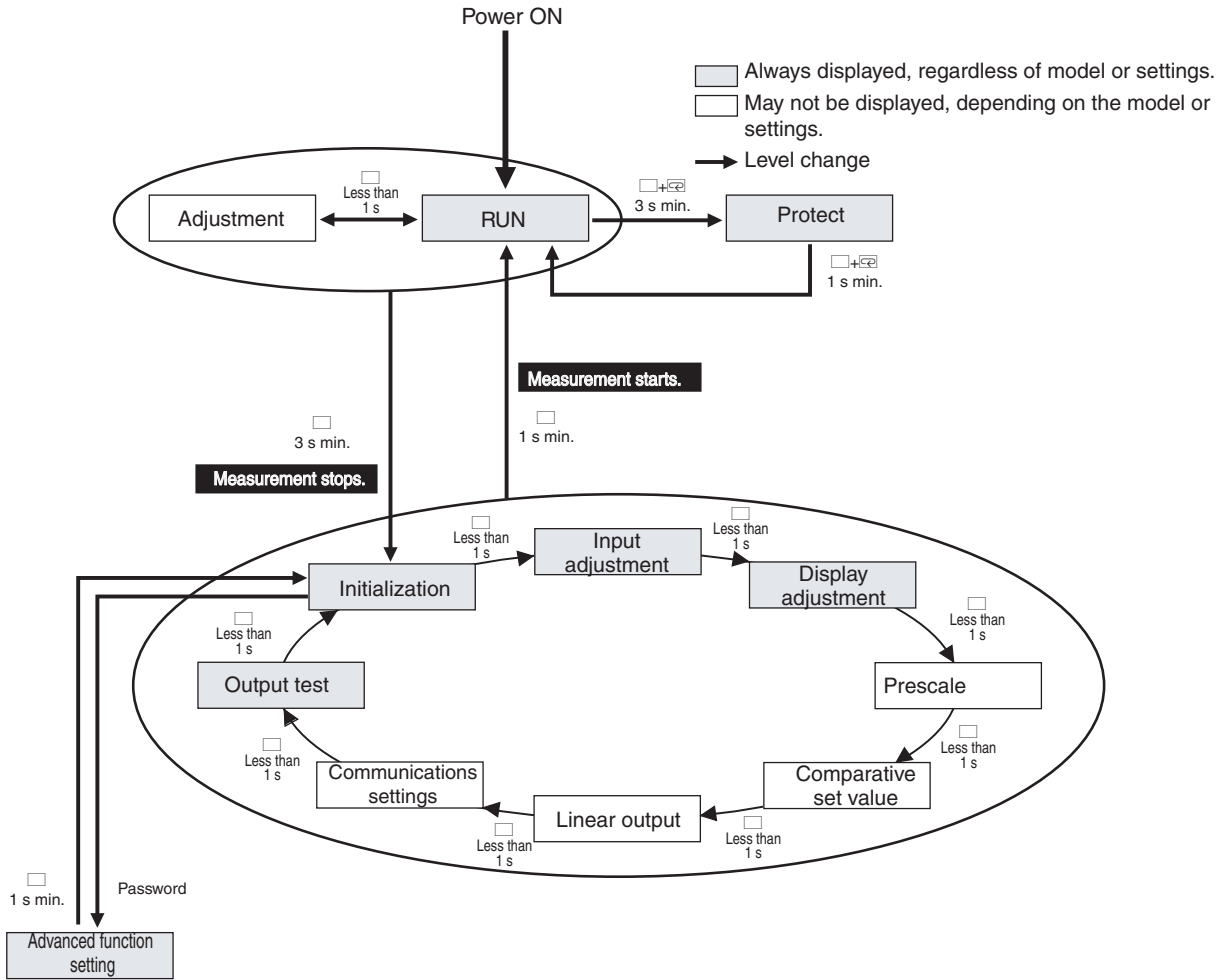

### To Protect Level

Press the  [LEVEL] and  [MODE] Keys in RUN level for at least 1 s. The PV display will start to flash. Press the same keys for at least 2 s to move to protect level. Press the  [LEVEL] and  [MODE] Keys for at least 1 s to return to RUN level.

### To Adjustment Level

Press the  [LEVEL] Key in RUN level once (less than 1 s). The level will change to adjustment level when the key is released. Use the same operation to return from adjustment level to RUN level.

### To Initial Setting Level

Press the  [LEVEL] Key in RUN or adjustment level for at least 1 s. The PV display will start to flash. Press the  [LEVEL] Key for at least 2 s to move to the initial setting level. Press the  [LEVEL] Key for at least 1 s to return to the RUN level from the initial setting level.

### Input Adjustment Level, Display Adjustment Level, Prescale Level, Comparative Set Value Level, Linear Output Level, Communications Setting Level, Output Test Level

First, move to initial setting level. Press the  [LEVEL] Key in initial setting level (less than 1 s) each time to move to the next level. Move to the next level from the output test level to return to the initial setting level.

### Advanced Function Setting Level

A special operation is required to move to the advanced function setting level. Use the following procedure.

**Procedure**

The Setting Level Protect setting must be set to 0 (SET Pt=0) to enable moving to the advanced function setting level.

Refer to "5.34 Limiting Key Operations" (P.5-85) for the procedure to release protection.

- A** Move to the initial setting level, press the [MODE] Key several times to display the "Añow" (move to advanced function setting level) parameter.
- B** Press the [SHIFT] Key to enable entering the password.
- C** Use the [SHIFT] and [UP] Keys to set the password. The password is "-0169" (-0169).
- D** Press the [MODE] Key to write the password.

- The advanced function setting level will be entered if the password is correct.
- If the password is incorrect, the first parameter on the initial setting level will be displayed.

The set value is always 0 after moving from character display to monitor status.

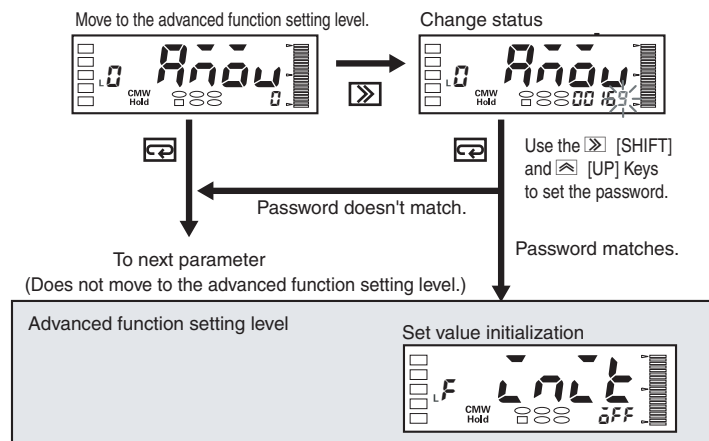

## ■ Monitoring and Changing Set Values

The value set for a parameter is called the “set value.”  
Set values can be numerals or characters.

When the SV display is lit, it is called the “monitor status.” When the SV display is flashing, it is called the “change status.”

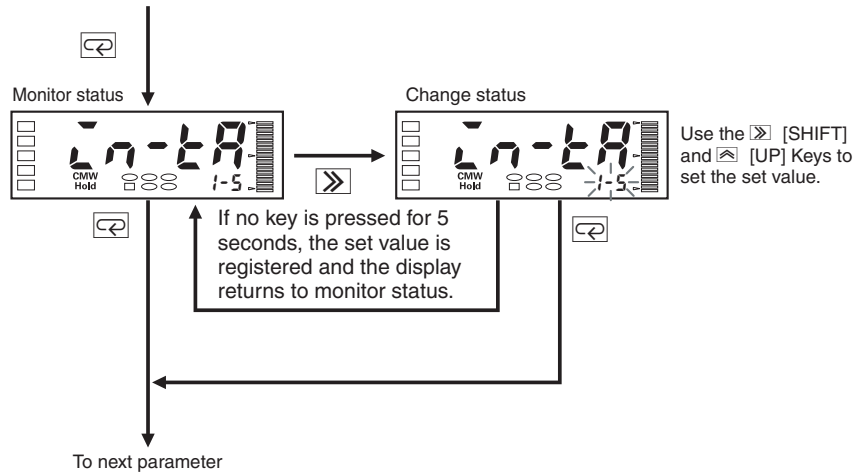

Use the following procedure to change set values.

### **Procedure**

**A** The parameter to be changed is displayed.

- At this stage, the set value is displayed but cannot be changed.

**B** Press the [SHIFT] Key once to enable changing the setting.

- The place that can be changed starts to flash.

**C** Use the [SHIFT] and [UP] Keys to change the setting.

**D** Press the [MODE] Key to switch to the next parameter.

- The changed set value is stored in the internal memory.
- If no key is pressed at step C for 5 s,\* the set value is registered and the display automatically returns to monitor status.

\* If the display is on RUN level or adjustment level, the time before the return to monitor status depends on the setting for the “automatic display return time.” If the “automatic display return time” setting is less than 5 s, for example, 3 s, then if there are no key operations in change status for 3 s, the changed set value is registered and the display automatically returns to the display when the power was turned ON.

## ■ Confirming and Changing Comparative Set Values

Comparative set values are confirmed and changed in RUN level.  
(The Unit keeps operating even while comparative set values are being confirmed and changed.)

The comparative set values from HH to LL are displayed each time the [MODE] Key is pressed in the operation status immediately after the power is turned ON. The SV display status (HH)(H)(L)(LL) is lit for the displayed comparative set value.

Some comparative set values may not be displayed, depending on the relay/transistor output specifications and settings.

Refer to the parameter setting procedures for information on how to change comparative set values.

\*Outputs of the K3HB-C are given in parentheses.

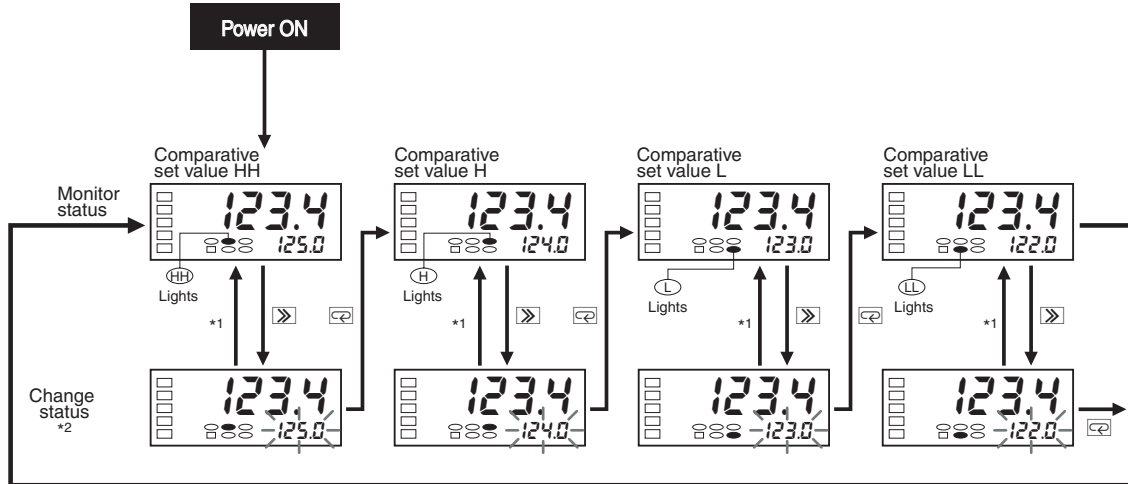

\*1 If no key is pressed for 5 seconds, the set value is registered and the display returns to monitor status.

\*2 Use the [SHIFT] and [UP] Keys to set the set value.

### Displayed Comparative Set Values

Relay/transistor output specifications	Displayed comparative set values			
	HH	H	L	LL
H/L Models with Relay Outputs <C1>		○	○	
HH/H/L/LL Models with Relays Outputs <C2>	○	○	○	○
HH/H/PASS/L/LL Models with Transistor Outputs <T1><T2>	○	○	○	○
None*				

\* For Sensor Power Supply/Output Models with a PASS Output, the displayed comparative set value depends on the allocation setting of the PASS output.

PASS (PASS output change)	Displayed comparative set value			
	HH	H	L	LL
LL				○
L			○	
PASS				
H		○		
HH	○			

"5.16 Allocating Another Output to PASS Output" → P.5-52

\* When  $5u.d5P$  (comparative set value display) is set to OFF, comparative set values are not displayed during operation but are displayed with key operations.

### Parameter Setting Procedure



**A** Press the  [MODE] Key several times to display the comparative set value to be changed.

- One of the values between HH and LL will flash, according to the displayed comparative set value.

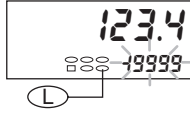

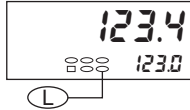

**B** Press the  [SHIFT] Key to make the SV display flash.

- The setting can be changed when the SV display starts to flash.

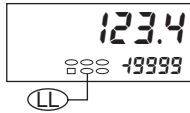

**C** Use the  [SHIFT] Key and  [UP] Key to change the comparative set value.



**D** Press the  [MODE] Key to switch to the next parameter.

- The comparative set value set in step C is registered.

## 5.1 Setting the Function for the K3HB-R

Initial setting level

R

The K3HB-R supports six different measurement operations.

Explanation of Functions	Functions
--------------------------	-----------

### ■ F1: Rpm/Circumferential Speed

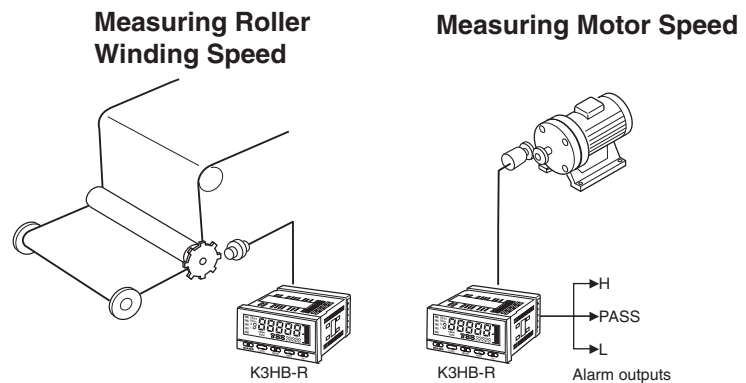

Operation Configuration (Application)

#### • Basic Operation

The input frequency of input A is multiplied by 60 and the rotational speed is displayed in rpm. Setting a prescale value enables the measurement value to be displayed in any unit. The measurement value can be obtained using the following formula:

$$D = fa \times 60 \times \alpha$$

$fa$ : Frequency A (Hz)

$\alpha$ : Prescale value A

$D$ : Measurement value

Referring to the following table, specify the prescale value corresponding to the desired display unit.

Calculated value	Display unit	Prescale value ( $\alpha$ )
Rpm	rpm	1/N
	rps	1/60 N
Input pulse frequency	Hz	1/60
	kHz	1/60,000
Circumferential speed	mm/s	1000 $\pi d/60 N$
	cm/s	100 $\pi d/60 N$
	m/s	$\pi d/60 N$
	m/min	$\pi d/N$
	km/h	0.06 $\pi d/N$

N: Pulses per rotation  
 $\pi d$ : Circumferential length per rotation

Example:

This example shows the prescale value and the prescale set values for displaying the speed of a roller using a proximity sensor that outputs five pulses per rotation.

Prescale value ( $\alpha$ ) =  $1/5 = 2.0 \times 10^{-1}$

Prescale value of Input A, X (mantissa): *PS.  $\overline{R\bar{U}}$  = 2.0000*

Prescale value of Input B, Y (exponent): *PS.  $\overline{RY}$  = 10 - 1*

## ■ F2: Absolute Ratio

### Measuring the Speed Ratio Between Two Rollers

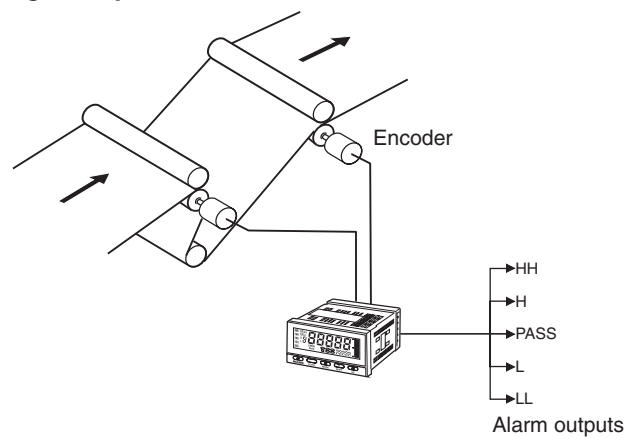

Operation Configuration (Application)

#### • Basic Operation

The absolute ratio between the frequency of input A and the frequency of input B is displayed as a percentage (%).

The measurement value can be obtained using the following formula:

$$D = \frac{fb \times \beta}{fa \times \alpha} \times 100$$

$fa$ : Frequency A (Hz)

$fb$ : Frequency B (Hz)

$\alpha$ : Prescale value A

$\beta$ : Prescale value B

$D$ : Absolute ratio (%)

\* When  $fa \times \alpha = 0$ , an overflow will be displayed at the upper limit. When  $fa \times \beta = 0$ , 0 will be displayed.

Example:

This example shows the prescale values and the prescale set values for displaying the absolute ratio between two rpm's using two rotary encoders, each of which outputs 1,000 pulses per rotation.

Prescale value of Input A ( $\alpha$ ) =  $1/1,000 = 1.0000 \times 10^{-3}$

Prescale value of Input B ( $\beta$ ) =  $1/1,000 = 1.0000 \times 10^{-3}$

Prescale value of Input A, X (mantissa): *PS.  $\overline{R\bar{U}}$  = 1.0000*

Prescale value of Input A, Y (exponent): *PS.  $\overline{RY}$  = 10 - 3*

Prescale value of Input B, X (mantissa): *PS.  $\overline{b\bar{U}}$  = 1.0000*

Prescale value of Input B, Y (exponent): *PS.  $\overline{bY}$  = 10 - 3*



## ■ F3: Error Ratio

### Measuring the Line Speed Error Ratio between Two Conveyors

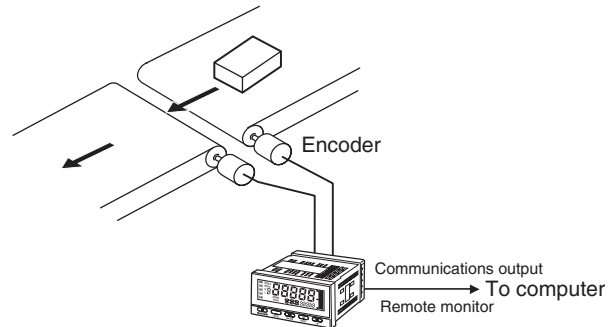

Operation Configuration (Application)

#### • Basic Operation

The error ratio between the frequency of input A and the frequency of input B is displayed as a percentage (%). The measurement value can be obtained using the following formula:

$$D = \frac{fb \times \beta - fa \times \alpha}{fa \times \alpha} \times 100$$

$fa$ : Frequency A (Hz)

$fb$ : Frequency B (Hz)

$\alpha$ : Prescale value A

$\beta$ : Prescale value B

$D$ : Error ratio (%)

\* When  $fa \times \alpha = 0$ , an overflow will be displayed at the upper limit. (When  $fa \times \beta = 0$ , 0 will be displayed.)

Example:

This example shows the prescale values and the prescale set values for displaying the line speed (m/min) error ratio between two conveyors using two rotary encoders, each of which outputs 100 pulses per rotation. (The circumferential length of the rotary encoder is 0.125 m.)

Prescale value of Input A ( $\alpha$ ) =  $0.125/100 = 0.00125 = 1.2500 \times 10^{-3}$

Prescale value of Input B ( $\beta$ ) =  $0.125/100 = 0.00125 = 1.2500 \times 10^{-3}$

Prescale value of Input A, X (mantissa):  $PS. A\bar{X} = 1.2500$

Prescale value of Input A, Y (exponent):  $PS. AY = 10^{-3}$

Prescale value of Input B, X (mantissa):  $PS. b\bar{X} = 1.2500$

Prescale value of Input B, Y (exponent):  $PS. bY = 10^{-3}$

## ■ F4: Rotational Difference

### Measuring the Rpm/Circumferential Speed Difference (Absolute Difference) between Two Conveyors

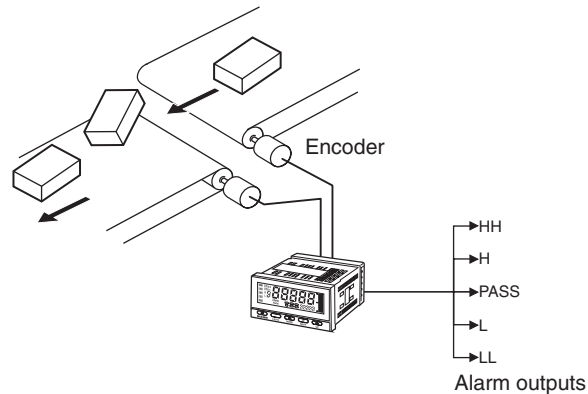

Operation Configuration (Application)

#### • Basic Operation

The difference between the speed of input A and the speed of input B is displayed.

The measurement value can be obtained using the following formula:

$$D = fb \times 60 \times \beta - fa \times 60 \times \alpha$$

$fa$ : Frequency A (Hz)

$fb$ : Frequency B (Hz)

$\alpha$ : Prescale value A

$\beta$ : Prescale value B

$D$ : Measurement value

Example:

This example shows the prescale values and the prescale set values for displaying the difference between speeds using two rotary encoders, each of which outputs 60 pulses per rotation.

Prescale value of Input A ( $\alpha$ ) =  $1/60 = 0.01666 \dots \approx 1.6666 \times 10^{-2}$

Prescale value of Input B ( $\beta$ ) =  $1/60 = 0.01666 \dots \approx 1.6666 \times 10^{-2}$

Prescale value of Input A, X (mantissa):  $PS. \overset{\sim}{A} = 1.6666$

Prescale value of Input A, Y (exponent):  $PS. \overset{\sim}{AY} = 10^{-2}$

Prescale value of Input B, X (mantissa):  $PS. \overset{\sim}{b} = 1.6666$

Prescale value of Input B, Y (exponent):  $PS. \overset{\sim}{bY} = 10^{-2}$

## ■F5: Flow Rate Ratio

### Monitoring Liquid Mixture Flow Rate Ratio

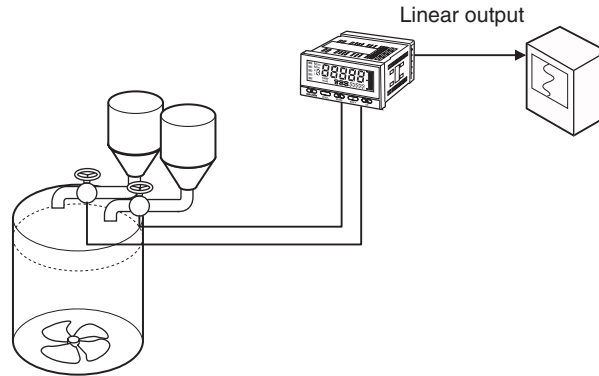

Operation Configuration (Application)

#### • Basic Operation

The flow rate ratio (%) of input B is displayed on the basis of the frequency of input A and the frequency of input B.

The measurement value can be obtained using the following formula:

$$D = \frac{fb \times \beta}{fa \times \alpha + fb \times \beta} \times 100$$

$fa$ : Frequency A (Hz)

$fb$ : Frequency B (Hz)

$\alpha$ : Prescale value A

$\beta$ : Prescale value B

$D$ : Flow rate ratio (%)

\* When  $fa \times \alpha + fb \times \beta = 0$ , 0 will be displayed.

Example:

This example shows the prescale values and the prescale set values for measuring the flow rate ratio from flow rates (l/min) using two flow meters (10 l/400 rpm).

Prescale value of Input A ( $\alpha$ ) =  $10/400 = 0.025 = 2.5000 \times 10^{-2}$

Prescale value of Input B ( $\beta$ ) =  $10/400 = 0.025 = 2.5000 \times 10^{-2}$

Prescale value of Input A, X (mantissa):  $PS. A\bar{X} = 2.5000$

Prescale value of Input A, Y (exponent):  $PS. AY = 10^{-2}$

Prescale value of Input B, X (mantissa):  $PS. b\bar{X} = 2.5000$

Prescale value of Input B, Y (exponent):  $PS. bY = 10^{-2}$

## ■ F6: Passing Time

### Measuring Conveyor Line Passing Time

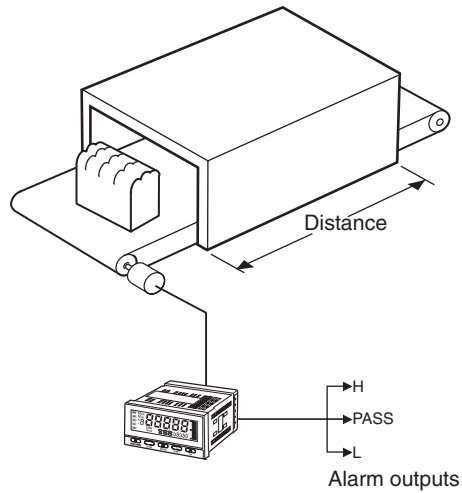

Operation Configuration (Application)

#### • Basic Operation

The cycle of the input pulse (1/Hz) of input A is measured and displayed.

The passing time is displayed in the desired unit by setting a prescale value.

- The measurement value can be obtained using the following formula:

$$D = \frac{1}{f_a} \times \alpha$$

$f_a$ : Frequency A (Hz)

$\alpha$ : Prescale value A

$D$ : Passing time

$$\text{rpm} = \text{Input frequency} \times \frac{1}{\text{Number of pulses per rotation}}$$

$$\text{Circumferential speed} = \text{Roller circumference} (\pi d) \times \text{rpm}$$

$$\text{Passing time} = \frac{\text{Length of processing stage}}{\text{Circumferential speed}}$$

Referring to the following table, specify the prescale value corresponding to the desired display unit.

Calculated value	Display unit	Prescale value ( $\alpha$ )
Passing time	s	$L/(\pi d/N)$

N: Pulses per rotation

$\pi d$ : Circumferential length per rotation

L: Length of processing stage

**Note:** If the frequency ( $f_a$ ) = 0, the characters for the overflow state will be shown at the upper limit.

Example:

This example shows the prescale values and the prescale set values for measuring the passing time using a rotary encoder that outputs 100 pulses per rotation.

Circumferential length per rotation ( $\pi d$ ) = 0.125 mm

Length of processing stage = 5 m

Prescale value ( $\alpha$ ) =  $5/(0.125/100) = 4,000 = 4.0000 \times 10^3$

Prescale value of Input A, X (mantissa): *PS. RW* = 4.0000

Prescale value of Input A, Y (exponent): *PS. RY* = 10 03

Use the following parameter to set the function.

0 FUNC  
(FUNC)

Parameter	Set value	Meaning of set value
Function FUNC	F1	Rpm/circumferential speed
	F2	Absolute ratio
	F3	Error ratio
	F4	Rotational difference
	F5	Flow rate ratio
	F6	Passing time

Parameter	Set value	Time display	Communications output data unit
Time unit	OFF	99999s	seconds
	minutes	99999min	minutes
	hours: min- utes:sec- onds	9h99min99s	minutes
	min- utes:sec- onds:100 millisec- onds	99min99s9digit	seconds

**Note 1:** The time unit can be set only when the passing time (F6) is selected.

**Note 2:** The display will flash if the number of pulses is for less than one second because the time is always displayed in minutes and seconds. In this case, this function cannot be used.



Displays "L0."



### Parameter Setting Procedure

**A** Press the [LEVEL] Key for at least 3 s in RUN level to move to the initial setting level.

- "L0" is displayed on the level/bank display to indicate the initial setting level.



**B** Press the [SHIFT] Key to make the SV display flash.

- The setting can be changed when the SV display starts to flash.



**C** Use the [UP] Key to change the set value.

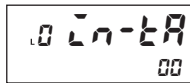

**D** Press the [MODE] Key to switch the display to the next PV.

- The set value is registered.

## 5.2 Setting the Function for the K3HB-P

Initial setting level

P

The K3HB-P supports six different measurement operations.

Explanation of Functions	Function
--------------------------	----------

### ■ F1: Passing Speed

#### Measuring Workpiece Passing Speed between A and B

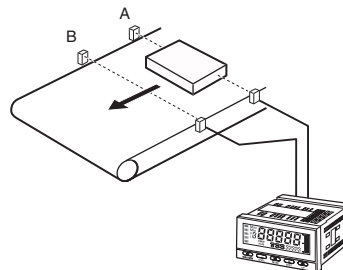

Operation Configuration (Application)

#### • Basic Operation

The reciprocal of the time  $T$  (s) from the turning ON of input A to the turning ON of input B is multiplied by 60 and the workpiece passing speed between points A and B is displayed.

$$D = \frac{1}{T} \times 60 \times \alpha$$

$T$ : Time (s) from the rising edge of input A to the rising edge of input B

$\alpha$ : Prescale value A

$D$ : Passing speed

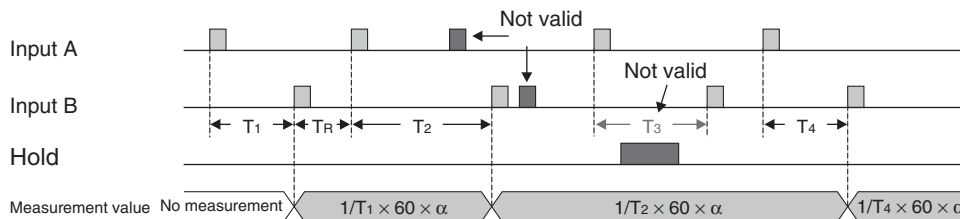

#### \*TR: Recovery Time

The time required from the end of one measurement until completing preparations for the next measurement. Allow at least 20 ms.

Referring to the following table, specify the prescale value corresponding to the desired display unit.

Calculated value	Display unit	Prescale value ( $\alpha$ )
Passing speed	mm/s	1000 L/60
	m/s	L/60
	m/min	L
	cm/s	100 L/60
	cm/min	100 L
	km/h	0.06 L

L: Sensor interval (m)

## ■ F2: Cycle

### Measuring Feed Cycles for Parts

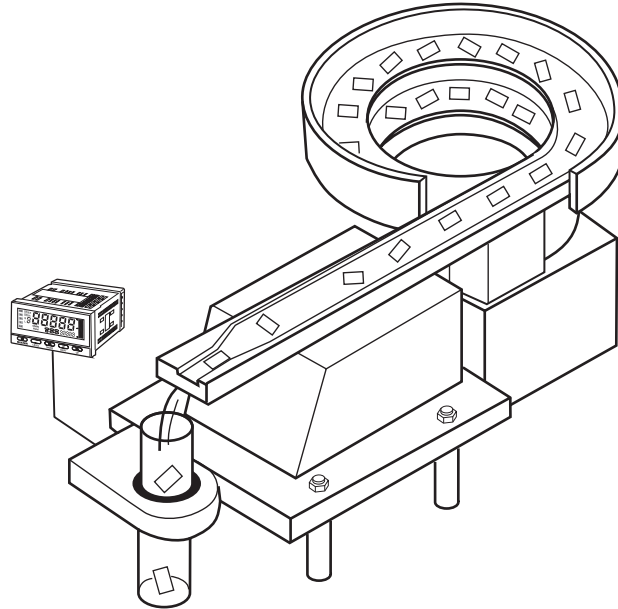

Operation Configuration (Application)

#### • Basic Operation

The time  $T$  (s) from one input A ON to the next is displayed. The measurement value can be obtained using the following formula:

$$D = T \times \alpha$$

$T$ : Time (s) between input A rising edges

$\alpha$ : Prescale value A

$D$ : Cycle

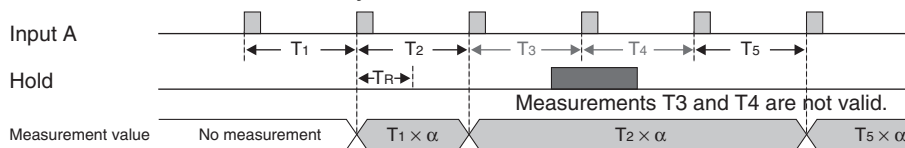



\*TR: Recovery Time

The time required from the end of one measurement until completing preparations for the next measurement. Allow at least 20 ms.

Referring to the following table, specify the prescale value corresponding to the desired display unit.

Calculated value	Display unit	Prescale value ( $\alpha$ )
Cycle	s	1
	min	1/60

### ■ F3: Time Difference

Measuring Workpiece Passing Time between A and B

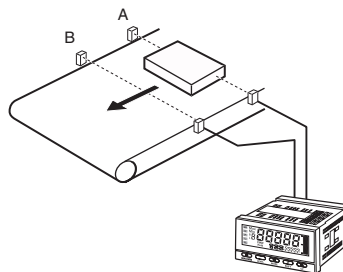

Measuring Differences in Length of Workpiece Steps

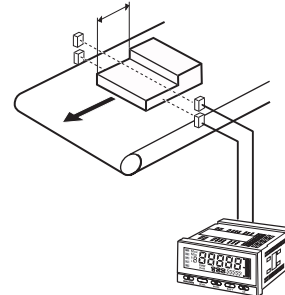

Operation Configuration (Application)

• **Basic Operation**

The time  $T$  (s) from input A ON to input B ON is displayed.

$$D = T \times \alpha$$

$T$ : Time from input A rising edge to input B rising edge (s)

$\alpha$ : Prescale value A

$D$ : Time difference

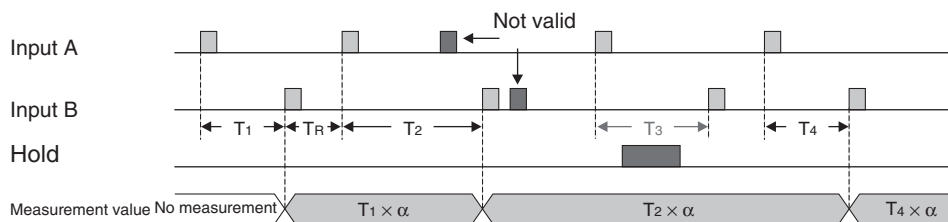

\*TR: Recovery Time

The time required from the end of one measurement until completing preparations for the next measurement. Allow at least 20 ms.

Referring to the following table, specify the prescale value corresponding to the desired display unit.

Calculated value	Display unit	Prescale value ( $\alpha$ )
Time difference	s	1
	min	1/60

## ■ F4: Time Band

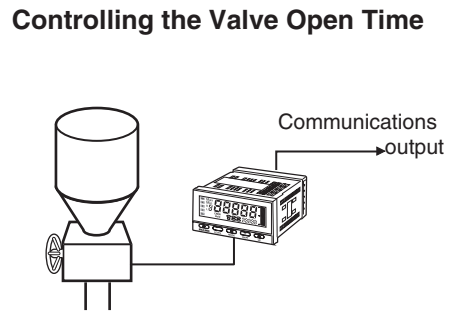
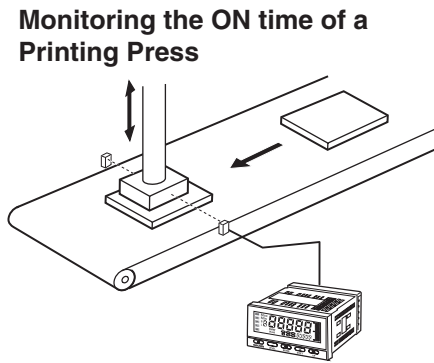

### Operation Configuration (Application)

#### • Basic Operation

The ON time  $T$  (s) of input A is displayed.

$$D = T \times \alpha$$

$T$ : ON time (s) of input A

$\alpha$ : Prescale value A

$D$ : Time band

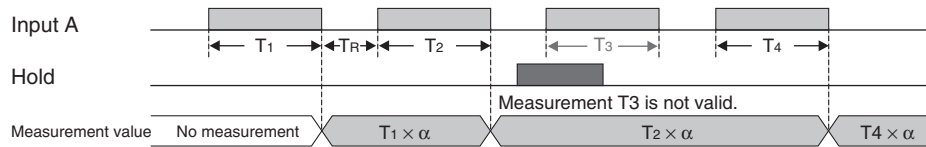

\*TR: Recovery Time

The time required from the end of one measurement until completing preparations for the next measurement. Allow at least 20 ms.

Referring to the following table, specify the prescale value corresponding to the desired display unit.

Calculated value	Display unit	Prescale value ( $\alpha$ )
Time band	s	1
	min	1/60

## ■ F5: Measuring Length

Measuring workpiece length

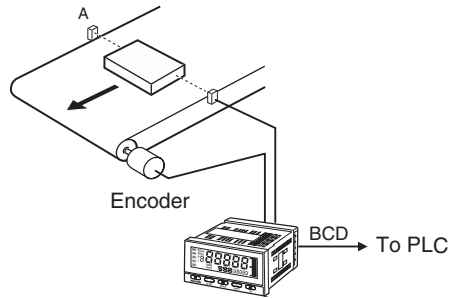

Operation Configuration (Application)

### • Basic operation

Displays the number of input A pulses while input B is ON.

The measurement value can be obtained using the following formula:

$$D = C \times \alpha$$

C: Number of pulses of input A while input B is ON

$\alpha$ : Prescale value A

D: Measured length

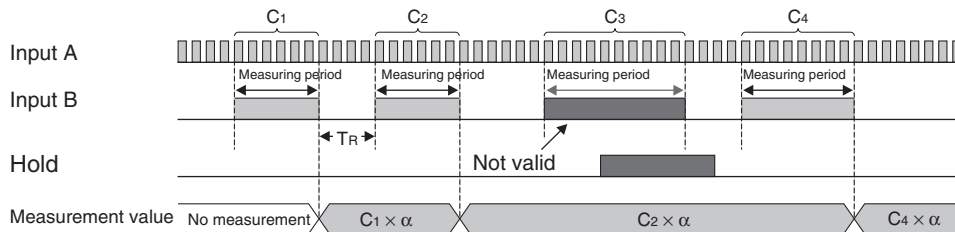

\*TR: Recovery Time

The time required from the end of one measurement until completing preparations for the next measurement. Allow at least 20 ms.

Referring to the following table, specify the prescale value corresponding to the desired display unit.

Calculated value	Display unit	Prescale value ( $\alpha$ )
Measured length	mm	$1000 \pi da / Na$
	cm	$100 \pi da / Na$
	m	$\pi da / Na$

Na: Number of input A pulses per rotation

$\pi da$ : Circumferential length (m) of Input A per rotation

**F6: Interval**

**Measuring Slit Intervals**

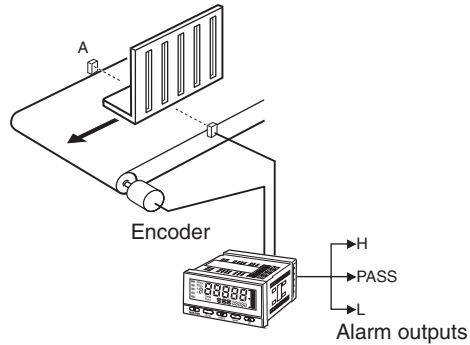

Operation Configuration (Application)

• Basic Operation

The number of input A pulses from one input B rising edge to the next is displayed.

The measurement value can be obtained using the following formula:

$$D = C \times \alpha$$

C: Number of input A pulses between input B rising edges

$\alpha$ : Prescale value A

D: Interval

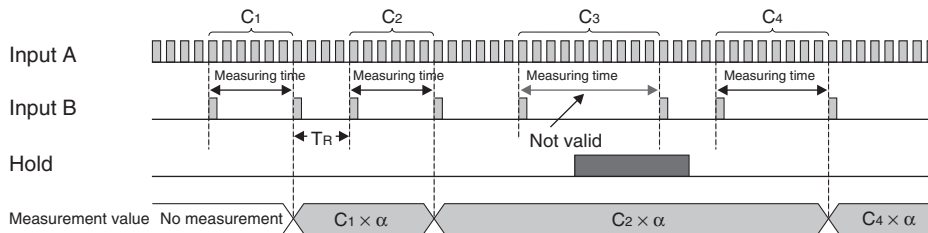

\*TR: Recovery Time

The time required from the end of one measurement until completing preparations for the next measurement. Allow at least 20 ms.

Referring to the following table, specify the prescale value corresponding to the desired display unit.

Calculated value	Display unit	Prescale value ( $\alpha$ )
Interval	mm	1000 $\pi da/Na$
	cm	100 $\pi da/Na$
	m	$\pi da/Na$

Na: Number of input A pulses per rotation

$\pi da$ : Circumferential length (m) of input A per rotation

Use the following parameter to set the function.



Parameter		Meaning of set value
Function FUNC	F1	Passing speed
	F2	Cycle
	F3	Time difference
	F4	Time band
	F5	Measuring length
	F6	Interval

### Parameter Setting Procedure



Displays "LD."



3 s min.

**A** Press the [LEVEL] Key for at least 3 s in RUN level to move to the initial setting level.

- "LD" is displayed on the level/bank display to indicate the initial setting level.

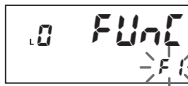

**B** Press the [SHIFT] Key to make the SV display flash.

- The setting can be changed when the SV display starts to flash.



**C** Use the [UP] Key to change the set value.

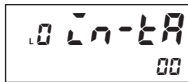

**D** Press the [MODE] Key to switch the display to the next PV.

- The set value is registered.



## ■ F2: Phase Differential Inputs

This function is normally used when connected to an incremental rotary encoder.

While input A is OFF, the count is decremented on the falling edge of input B and incremented on the rising edge of input B.

The measurement value can be obtained using the following formula:

$$D = C \times \alpha$$

*C*: Count

$\alpha$ : Prescale value A

*D*: Measurement value

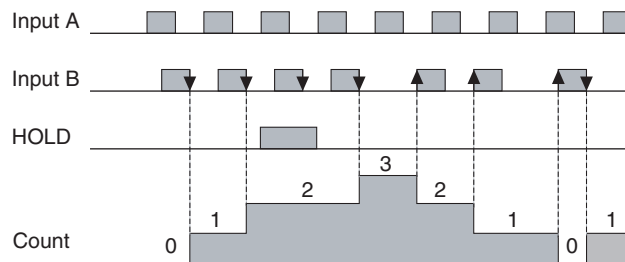

- Holding the Measurement Value

Turning ON the HOLD input temporarily stops the cumulative count and holds the measurement value. The outputs are also held.

- Resetting the Display Value

The display value can be zeroed by turning ON the RESET input or press the MAX/MIN Key for 1 second or longer.

While the RESET input is ON, measurement is not performed, the display shows "----", and all outputs are OFF.

- Compensation Value Input

Use the compensation input to start measurement from the desired value. The compensation value must be set in advance.

## ■ F3: Pulse Counting Input

Pulses are counted on the rising edge of input A.

The measurement value can be obtained using the following formula:

$$D = C \times \alpha$$

*C*: Count

$\alpha$ : Prescale value A

*D*: Measurement value

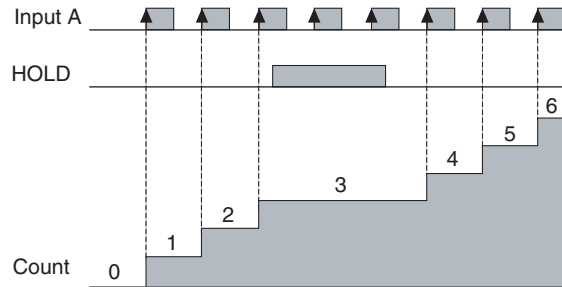

- Holding the Measurement Value

Turning ON the HOLD input temporarily stops the cumulative count and holds the measurement value. The outputs are also held.

- Resetting the Display Value

The display value can be zeroed by turning ON the RESET input or press the MAX/MIN Key for 1 second or longer.

While the RESET input is ON, measurement is not performed, the display shows "-----", and all outputs are OFF.

- Compensation Value Input

Use the compensation input to start measurement from the desired value. The compensation value must be set in advance.



Use the following parameter to set the function.



Parameter	Set value	Meaning of set value
Function FUNC	F1	Individual inputs
	F2	Phase differential inputs
	F3	Pulse counting input

### Parameter Setting Procedure

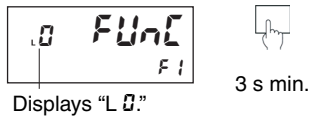

**A** Press the [LEVEL] Key for at least 3 s in RUN level to move to the initial setting level.

- "L0" is displayed on the level/bank display to indicate the initial setting level.

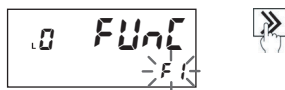

**B** Press the [SHIFT] Key to make the SV display flash.

- The setting can be changed when the SV display starts to flash.



**C** Use the [UP] Key to change the set value.

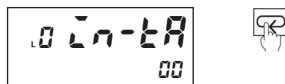

**D** Press the [MODE] Key to switch the display to the next PV.

- The set value is registered.

# 5.4 Setting Input Types

Initial setting level

R P C

Set the input type to match the connected input device.

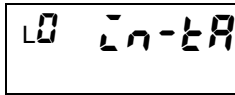

(IN-TA)

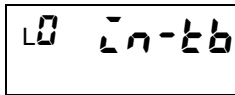

(IN-TB)

Parameter	Set value	Meaning of set value
Input type A IN-TA	00	Open collector (NO) or voltage pulse (H)
	01	Open collector (NC) or voltage pulse (L)
	10	Relay contact (NO) or voltage pulse (H)
	11	Relay contact (NO) or voltage pulse (L)
Input type B IN-TB (See note.)	00	No-voltage contact (NO) or voltage pulse (H)
	01	No-voltage contact (NC) or voltage pulse (L)
	10	Contact (NO) or voltage pulse (H)
	11	Contact (NC) or voltage pulse (L)

**Note:** Not displayed on the K3HB-C when F3 has been selected.

### Parameter Setting Procedure: Input Type

The following procedure shows an example using the K3HB-R.



Displays "LD."



3 s min.

**A** Press the [LEVEL] Key for at least 3 s in RUN level to move to the initial setting level.

- "LD" is displayed on the level/bank display to indicate the initial setting level.

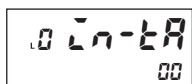

**B** If the PV display is not "IN-TA" or "IN-TB," press the [MODE] Key to display the desired parameter.

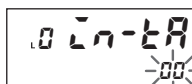

**C** Press the [SHIFT] Key to make the SV display flash.

- The setting can be changed when the SV display starts to flash.

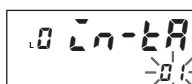

**D** Use the [UP] Key to change the set value.

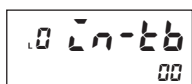

**E** Press the [MODE] Key to switch to the next parameter.

- The set value is registered.

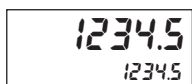

1 s min.

**F** Press the [LEVEL] Key for at least 1 s to return to the RUN level.

## 5.5 Setting Prescale Values

Initial setting level

R P C

### One Point

Set scaling to convert and display input values as any values. Separate settings are made for inputs A and B.

When bank selection has been enabled, the prescale values for each bank must be set in the prescale level. When bank selection has been disabled, the prescale values must be set in the initial setting level.

Refer to "5.30 Using Prescale/Comparative Set Value Banks" (P.5-76).

#### Setting Parameter for Input A

L0 PS.A $\bar{u}$

(PS.AX)

L0 PS.A $\bar{y}$

(PS.AY)

L0 PS.b $\bar{u}$

(PS.BX)

L0 PS.b $\bar{y}$

(PS.BY)

L0 dP

(DP)

Parameter	Set value	Meaning of set value
Input A Prescale value X (mantissa) PS.A $\bar{u}$	0.0000 to 9.9999	Input A prescale value mantissa
Input A Prescale value Y (exponent) PS.A $\bar{y}$	-9 to 9	Input A prescale value exponent
Input B Prescale value X (mantissa) PS.b $\bar{u}$	0.0000 to 9.9999	Input B prescale value mantissa See note.
Input B Prescale value Y (exponent) PS.b $\bar{y}$	-9 to 9	Input B prescale value exponent See note.

**Note:** Not displayed on the K3HB-C or the K3HB-P.

The decimal point position for scaling values depends on the decimal point position [dP] setting.

Parameter	Set value	Meaning of set value
Decimal point position dP	00000	No decimal point
	0000.0	One digit below the decimal point is displayed.
	000.00	Two digits below the decimal point are displayed.
	00.000	Three digits below the decimal point are displayed.
	0.0000	Four digits below the decimal point are displayed.

Explanation of Functions Prescaling

Prescaling enables input values to be displayed using any unit by multiplying the input pulse frequency or count by a specific coefficient.

Example:

This example shows the prescale value and the prescale set values for displaying the speed of a rotary encoder that outputs 500 pulses per second. (The K3HB-R is used in function F1.)

$$D = fa \times 60 \times \alpha$$

*fa*: Frequency A (Hz)

$\alpha$ : Prescale value A

*D*: Measurement value (rpm)

Prescale value ( $\alpha$ ) =  $1/500 = 0.002 = 2.0 \times 10^{-3}$

Prescale value of Input A, X (mantissa): *PS.AX* = 2.0000

Prescale value of Input B, Y (exponent): *PS.AY* = 10 -3

Prescaling

Parameter Setting Procedure: Prescale Settings for Input A

The following procedure uses the K3HB-R as an example.

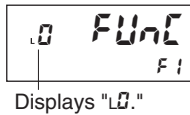

**A** Press the [LEVEL] Key for at least 3 s in RUN level to move to the initial setting level.

- "L0" is displayed on the level/bank display to indicate the initial setting level.

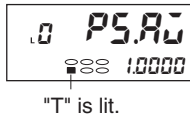

**B** Press the [MODE] Key several times to switch the PV display to "PS.AX."

- Teaching is possible for the prescale AX (mantissa) scaling input value. "T" is lit to indicate that teaching is possible.
- Refer to P.5-31 for the teaching method.

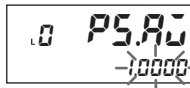

**C** Press the [SHIFT] Key to make the SV display flash.

- The setting can be changed when the SV display starts to flash.

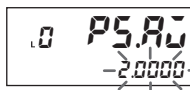

**D** Use the [UP] and [SHIFT] Keys to change the set value.



**E** Press the [MODE] Key to switch the PV display to "PS.AY."

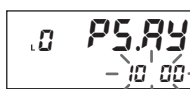

**F** Press the [SHIFT] Key to make the SV display flash.

- The setting can be changed when the SV display starts to flash.

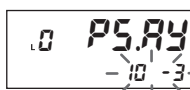

**G** Use the [UP] and [SHIFT] Keys to change the set value.

## Decimal Point Position



**H** Press the [MODE] Key to switch the PV display to the next parameter "dP".

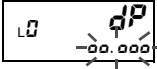

**I** Press the [SHIFT] Key to make the SV display flash.

- The setting can be changed when the SV starts to flash.

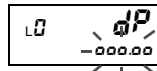

**J** Use the [UP] Key to change the set value.



**K** Press the [MODE] Key to switch to the next parameter.

- The set value is registered.

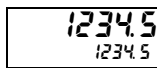

**L** Press the [LEVEL] Key for at least 1 s to return to the RUN level.

1 s min.

## Teaching

Use the teaching function to set the scaling input value "PS. RV" using a real input.

\* The K3HB-P does not support teaching.

### Parameter Setting Procedure

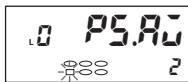

T lights.



After performing step B, press the [UP] Key.

- Teaching is enabled and "T" flashes.
- The setting changes to match the actual input.

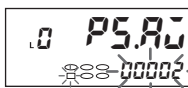

Press the [UP] Key again.

- The entered value is set and the SV starts flashing.

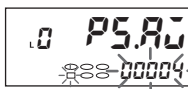

Use the [UP] and [SHIFT] Keys to change the set value.

- Change the set value to the desired value.

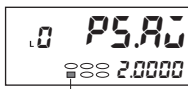

T changes from flashing to lit.



Press the [MODE] Key to set the displayed value.

- The prescale value calculated based on the input value and the display value is registered, and the display switch to monitor mode.
- In teaching status, pressing the [MODE] Key cancels teaching and switches to the next parameter.

Remarks

"5.30 Using Prescale/Comparative Set Value Banks" → P.5-76

# 5.6 Setting the Auto-zero Time

Input adjustment level

R

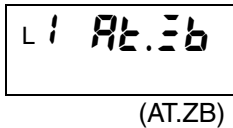
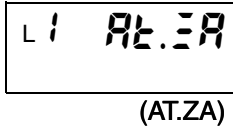

The frequency is forced to zero when there is no pulse for a specific period of time.

Parameter	Set value	Meaning of set value
Auto-zero time A At.3A	0.0 to 2999.9	Input A auto-zero time
Auto-zero time B At.3b	0.0 to 2999.9	Input B auto-zero time*

\* The input B auto-zero time cannot be set for function F1 or F6.

Explanation of Functions	Auto-zero Time
--------------------------	----------------

Due to the principle of forecasted cycle calculation, the frequency will not become zero even if the input signal is cut off. Refer to "Forecasted Cycle Calculation" (P.A-30) for details on forecast cycle calculations.

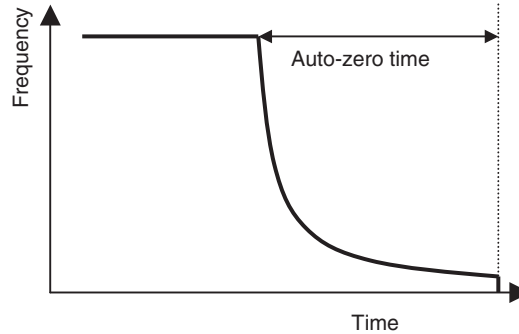

When there is no input pulse for a specified time, auto-zeroing can be used to force the measurement frequency to zero. The time from cutoff of the input pulse to the zeroing of the measurement frequency is called the "auto-zero time."

### Parameter Setting Procedure



Displays "L0."



3 s min.

**A** Press the [LEVEL] Key for at least 3 s in RUN level to move to the initial setting level.

- "L0" is displayed on the level/bank display to indicate the initial setting level.



Displays "L1."



Less than 1 s

**B** Press the [LEVEL] Key once (less than 1 s) to move to the input adjustment level.

- "L1" is displayed on the level/bank display to indicate the input adjustment level.

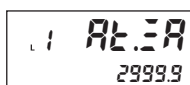

**C** Press the [MODE] Key several times to switch the PV display to "At.3A".

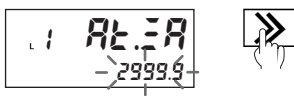

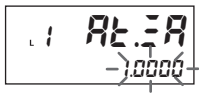

**D** Press the  [SHIFT] Key to make the SV display flash.

- The setting can be changed when the SV display starts to flash.



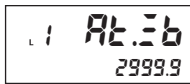

**E** Use the  [UP] and  [SHIFT] Keys to change the set value.

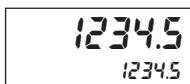

**F** Press the  [MODE] Key to switch to the next parameter.

- The set value is registered.



**G** Press the  [LEVEL] Key for at least 1 s to return to the RUN level.

1 s min.

## 5.7 Resetting Measurements

R P C

### ■ K3HB-R/P

When the RESET input turns ON or the  $\diamond$  [MAX/MIN] Key is pressed for at least 1 s, the maximum value, minimum value, and outputs are cleared. Measurement is not performed during RESET input.

### ■ K3HBC

When the RESET input turns ON or the  $\diamond$  [MAX/MIN] Key is pressed for at least 1 s, the display value, maximum value, and minimum value will be zeroed. Measurement is not performed while the RESET input is ON. The display will show ---- and all the outputs will be OFF.

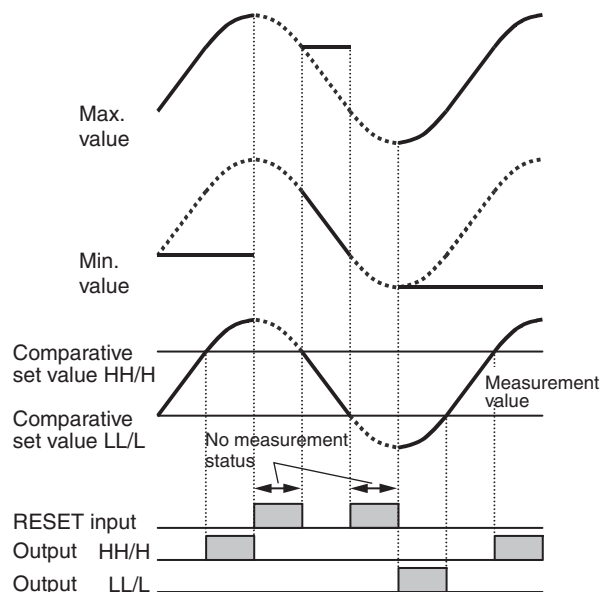

- The display during RESET input is "-----" and all outputs are OFF.
- HOLD and TIMING inputs are accepted, but measurement is disabled during RESET input.



"5.8 Not Performing Measurements for Set Intervals" → P.5-35



## 5.8 Not Performing Measurements for Set Intervals

Advanced function setting level

R

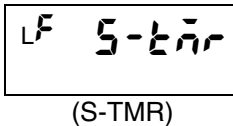

With this function measurement is not performed until a set time has passed after the S-TMR input turns ON. (Timing starts at the rising edge of the S-TMR input and the PV display is “-----” while no measurement has been performed.)

If the power is turned ON while the 5-tAr input is ON, measurement will not start until the time set in the 5-tAr elapses.

This can be used to create a waiting status until a rotating body reaches its normal speed range when the power to the K3HB and the rotating body is turned ON at the same time.

Use the following parameter to set the time.

Parameter	Set value	Meaning of set value
Startup compensation timer 5-tAr	0.0	Startup compensation timer disabled
	0.1 to 99.9	0.1 to 99.9 s

### Parameter Setting Procedure

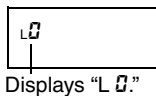

**A** Press the [LEVEL] Key for at least 3 s in RUN level to move to the initial setting level.

- “L0” is displayed on the level/bank display to indicate the initial setting level.

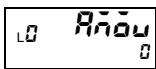

**B** Press the [MODE] Key several times to change the PV display to “RnAm.”

- This parameter is not displayed for the initial status due to setting level protect.  
Refer to "5.34 Limiting Key Operations" (P.5-85) for information on removing setting level protect.



**C** Press the [SHIFT] Key to make the SV display flash.

- The setting can be changed when the SV display starts to flash.

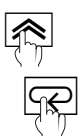
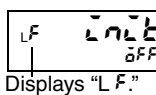

**D** Use the [UP] and [SHIFT] Keys to set the password “- 0 169.” Press the [MODE] Key to move to the advanced function setting level.

- “LF” is displayed on the level/bank display to indicate the advanced function setting level.

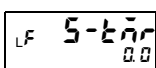

**E** Press the [MODE] Key several times to change the PV display to “5-tAr.”

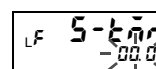

**F** Press the [SHIFT] Key to make the SV display flash.

- The setting can be changed when the SV display starts to flash.

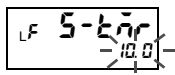

**G** Use the [UP] and [SHIFT] Keys to change the set value.

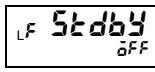

**H** Press the [MODE] Key to switch to the next parameter.

- The set value is registered.



**I** Press the [LEVEL] Key for at least 1 s to return to the initial setting level.

1 s min.

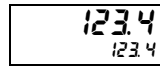

**J** Press the [LEVEL] Key for at least 1 s to return to RUN level.

1 s min.



"5.7 Resetting Measurements" → P.5-34

## 5.9 Averaging Input

Input adjustment level

R

Average processing of input values smooths the displays and outputs for inputs with extreme fluctuations, such as spike noise.

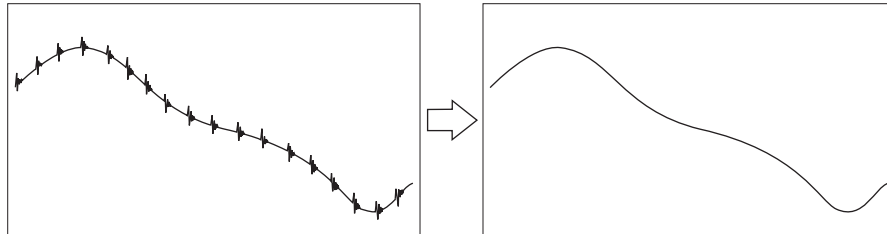

### Explanation of Functions | Average processing

There are two types of averaging: “simple” and “moving.” Select one type. The number of samples (“averaging times”) can also be specified for the input values to be averaged.

Simple averaging is used when the display refresh period is to be lengthened. Moving averaging is used to remove periodic noise superimposed on input signals.

The following graphs show the relationship between the data refresh periods for both simple and moving averaging processes when the averaging times is set to 4.

#### ● Simple Average

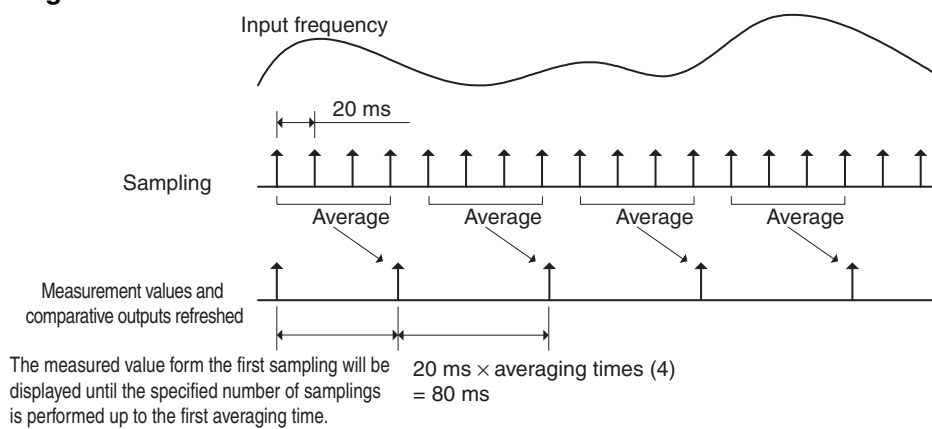

#### ● Moving Average

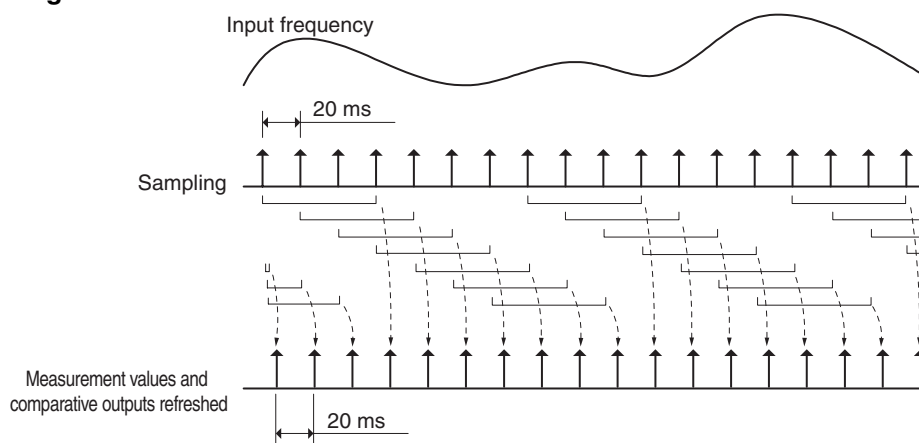

- The data refresh periods when averaging is used are given by model in the following table.

	Set value	Refresh period
No averaging	1	Every 20 ms
Simple average	2	Every 40 ms
	4	Every 80 ms
	8	Every 160 ms
	16	Every 320 ms
	32	Every 640 ms
	64	Every 1.28 s
	128	Every 2.56 s
	256	Every 5.12 s
	512	Every 10.24 s
1024	Every 20.48 s	
Moving average	1 to 1024	Every 20 ms

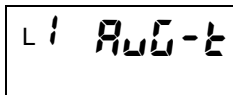

(AVG-T)

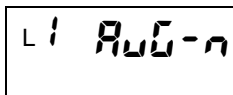

(AVG-N)

Averaging is set using the following parameters.

Parameter	Set value	Meaning of set value
Averaging type AVG-t	5ñPŁ	Simple average
	ñāuŁ	Moving average
Averaging times AVG-n	1	1
	2	2
	4	4
	8	8
	16	16
	32	32
	64	64
	128	128
	256	256
	512	512
1024	1024	

\* To not use averaging, set the average type "AVG-t" to 5ñPŁ and the averaging times "AVG-n" to 1.

**Parameter Setting Procedure**



Displays "L 0."



3 s min.

**A** Press the [LEVEL] Key for at least 3 s in RUN level to move to the initial setting level.

- "L 0." is displayed on the level/bank display to indicate the initial setting level.

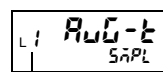

Displays "L 1."



Less than 1 s

**B** Press the [LEVEL] Key once (less than 1 s) to move to the input adjustment level.

- "L 1" is displayed on the level/bank display to indicate the input adjustment level.



**C** Press the [SHIFT] Key to make the SV display flash.

- The setting can be changed when the SV display starts to flash.



**D** Use the [UP] Key to change the average type setting.



**E** Press the [MODE] Key to change to the next parameter "AuG-n."

- The average type setting is registered.



**F** Press the [SHIFT] Key to make the SV display flash.



**G** Use the [UP] Key to change the averaging times setting.



**H** Press the [MODE] Key to switch to the next parameter.

- The averaging times setting is registered.



**I** Press the [LEVEL] Key for at least 1 s to return to RUN level.

1 s min.



"5.20 Changing the Display Refresh Period" → P.5-61

# 5.10 Changing Comparative Output Patterns

Initial setting level

R P C

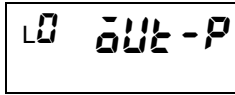

(OUT-P)

This function compares the measurement value and comparative set value and outputs the comparative result. The output pattern is set using the following parameter.

Parameter	Set value	Meaning of set value
Comparative output pattern aut-P	nanRL	Standard outputs (See note.)
	ianE	Zone outputs
	LEuEL	Level outputs

**Note:** Standard outputs cannot be specified with the K3HB-C.

## ■ K3HB-R/P

### ● Standard Outputs

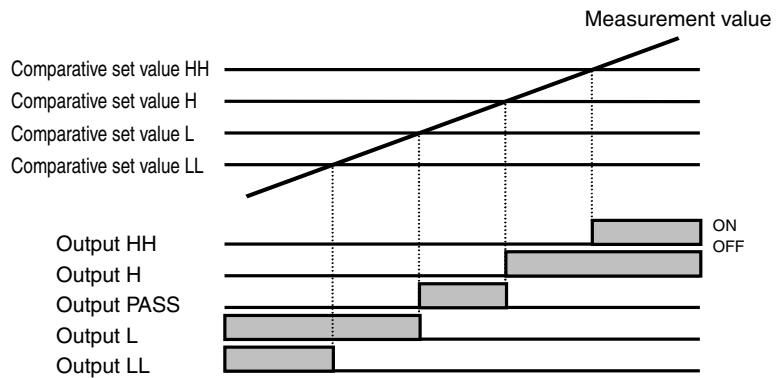

### ● Zone Outputs

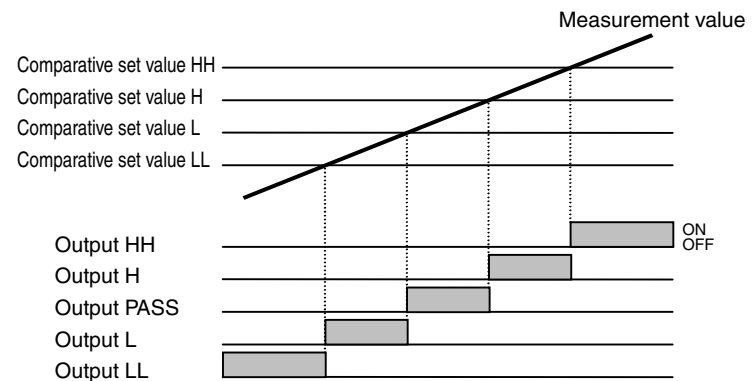

● Level Outputs

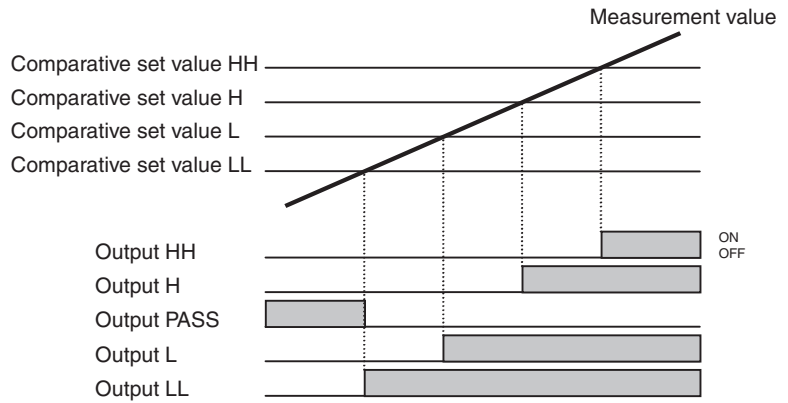

\* The PASS output turns ON when any of the HH, H, L, and LL outputs turns OFF.

■ K3HB-C

● Level Outputs

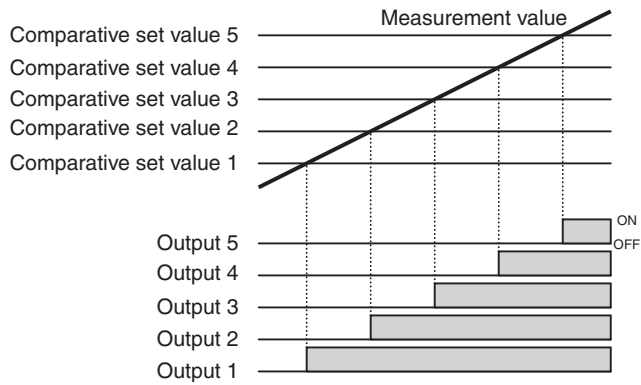

● Zone Outputs

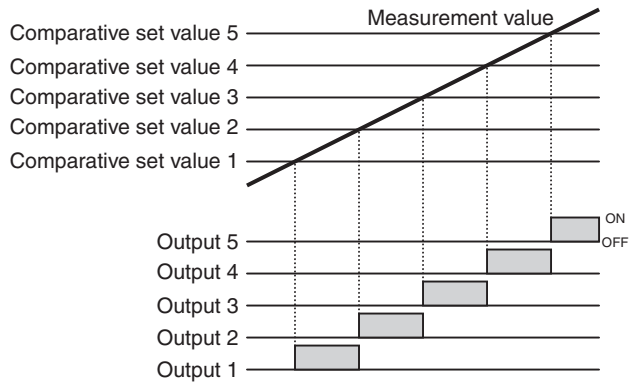

**Parameter Setting Procedure**

The following explanation uses the K3HB-R as an example.

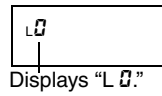

**A** Press the [LEVEL] Key for at least 3 s in RUN level to move to the initial setting level.  
 • "L0" is displayed on the level/bank display to indicate the initial setting level.



**B** Press the [MODE] Key several times to change the PV display to "out-P".

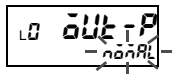

**C** Press the [SHIFT] Key to make the SV display flash.  
 • The setting can be changed and the SV display starts to flash.

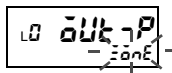

**D** Use the [UP] Key to change the set value.



**E** Press the [MODE] Key to switch to the next parameter.  
 • The set value is registered.

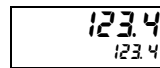

**F** Press the [LEVEL] Key for at least 1 s to return to RUN level.



- "5.11 Preventing Output Chattering" → P.5-43
- "5.12 Outputting for a Set Interval" → P.5-45
- "5.13 Delaying Output OFF Timing" → P.5-47
- "5.15 Holding Comparative Outputs" → P.5-50
- "5.16 Allocating Another Output to PASS Output" → P.5-52
- "5.17 Reversing Output Logic" → P.5-54
- "5.29 Performing Output Tests" → P.5-75



# 5.11 Preventing Output Chattering

Advanced function setting level

R

Chattering of a comparative output results from drift in the measurement value near a comparative set value. Chattering can be prevented by adjusting the hysteresis value.

Explanation of Functions	Hysteresis
--------------------------	------------

Hysteresis is a range between the value for which a comparative output turns ON and the value for which the comparative output turns OFF. When the comparative output turns ON, it turns OFF only after the change in measurement values is greater than the set hysteresis.

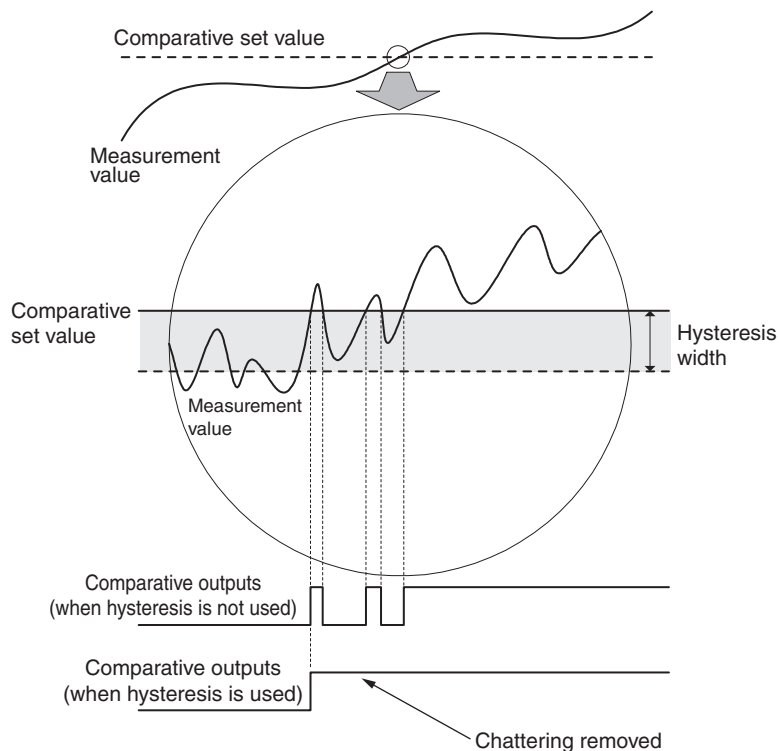

Hysteresis works in the direction of decreasing measurement values for comparative set values HH and H and works in the direction of increasing measurement values for comparative set values LL and L. Note that hysteresis works in the direction of decreasing measurement values for all set values if the output pattern is set to a level output.

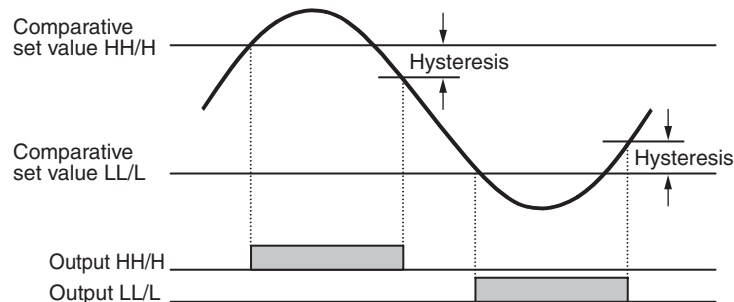



(HYS)

Hysteresis is set using the following parameter.

Parameter	Set value	Meaning of set value
Hysteresis HYS	0 to 9999	0 to 9,999 *

\* The decimal point depends on the “decimal point position” setting.

**Parameter Setting Procedure**

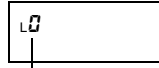

Displays “L 0.”



3 s min.

**A** Press the [LEVEL] Key for at least 3 s in RUN level to move to the initial setting level.

- “LD” is displayed on the level/bank display to indicate the initial setting level.

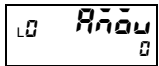

**B** Press the [MODE] Key several times to change the PV display to “Rn0u.”

- This parameter is not displayed for the initial status due to setting level protect. Refer to "5.34 Limiting Key Operations" (P.5-85) for information on removing setting level protect.

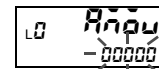

**C** Press the [SHIFT] Key to make the SV display flash.

- The setting can be changed when the SV display starts to flash.

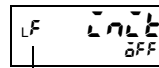

Displays “L F.”



**D** Use the [UP] and [SHIFT] Keys to set the password “0159.” Press the [MODE] Key to move to the advanced function setting level.

- “LF” is displayed on the level/bank display to indicate the advanced function setting level.

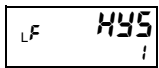

**E** Press the [MODE] Key several times to change the PV display to “HYS.”

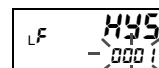

**F** Press the [SHIFT] Key to make the SV display flash.

- The setting can be changed when the SV display starts to flash.



**G** Use the [UP] and [SHIFT] Keys to change the set value.

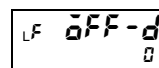

**H** Press the [MODE] Key to switch to the next parameter.

- The set value is registered.

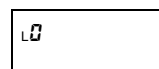

1 s min.

**I** Press the [LEVEL] Key for at least 1 s to return to the initial setting level.

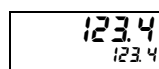

1 s min.

**J** Press the [LEVEL] Key for at least 1 s to return to RUN level.

## 5.12 Outputting for a Set Interval

Advanced function setting level

R P C

The shot output function turns OFF a comparative output after a set interval after it turns ON. The following diagram shows operation when the shot output is set to 100 ms on the K3HB-R.

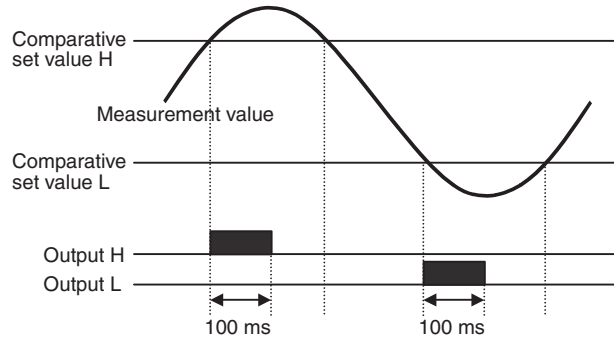

LF SHot  
(SHOT)

The shot output time is set using the following parameter.

Parameter	Set value	Meaning of set value
Shot output SHot	0 to 1999	0 to 1,999 ms (0 to 199.9 s)* The shot output will be disabled when set to 0.

\* The unit for K3HB-R settings is 100 ms. For example, if 10 is set, then the shot output time is  $10 \times 100 \text{ ms} = 1 \text{ s}$ .

The shot output time is an internal calculation time. The following times are added to the set time to give the actual output time.

- For relay outputs: 11 ms max.
- For transistor outputs: 1 ms max.

**Parameter Setting Procedure**

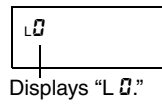

**A** Press the [LEVEL] Key for at least 3 s in RUN level to move to the initial setting level.

- "L 0" is displayed on the level/bank display to indicate the initial setting level.



**B** Press the [MODE] Key several times to change the PV display to "R000."

- This parameter is not displayed for the initial status due to setting level protect. Refer to "5.34 Limiting Key Operations" (P.5-85) for information on removing setting level protect.

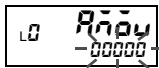

**C** Press the [SHIFT] Key to make the SV display flash.

- The setting can be changed when the SV display starts to flash.

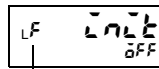

**D** Use the [UP] and [SHIFT] Keys to set the password "0100." Press the [MODE] Key to move to the advanced function setting level.

- "L F" is displayed on the level/bank display to indicate the advanced function setting level.

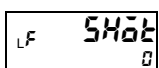

**E** Press the [MODE] Key several times to change the PV display to "5H00."



**F** Press the [SHIFT] Key to make the SV display flash.

- The setting can be changed when the SV display starts to flash.

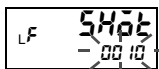

**G** Use the [UP] and [SHIFT] Keys to change the set value.

**Important**

Set the shot output time (5H00) to "0" to use the OFF delay (0FF-d). If set to anything else, 0FF-d (OFF delay) will be disabled.

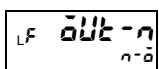

**H** Press the [MODE] Key to switch to the next parameter.

- The set value is registered.



**I** Press the [LEVEL] Key for at least 1 s to return to the initial setting level.

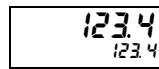

**J** Press the [LEVEL] Key for at least 1 s to return to RUN level.



"5.13 Delaying Output OFF Timing" → P.5-47

## 5.13 Delaying Output OFF Timing

Advanced function setting level

R P C

The output OFF delay function delays the OFF timing for comparative results.

The shot output (5Hōt) is given priority over the OFF delay (ōFF-d). The OFF delay will be disabled if the shot output is set to anything other than "0," regardless of the OFF delay setting.

### Explanation of Functions Output OFF delay

If the measurement value changes and the comparative result that had been ON until now turns OFF, the comparative output will be held for the time set for the output OFF delay parameter.

The comparative output ON time may be too short if measurement values change quickly. When comparative output signals are read by external devices, short signals may not be received properly. In such situations, the output OFF delay can be used to output comparative output signal values for a set duration or greater.

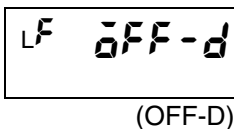

Output OFF delay is set using the following parameter.

Parameter	Set value	Meaning of set value
Output OFF delay ōFF-d	0 to 1999	0 to 1,999 ms (0 to 199.9 s)*

\* The unit for K3HB-R settings is 100 ms. For example, if 10 is set, then the output OFF delay is 10 × 100 ms = 1 s.

### Parameter Setting Procedure

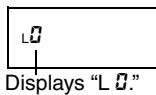

**A** Press the [LEVEL] Key for at least 3 s in RUN level to move to the initial setting level.

- "LD" is displayed on the level/bank display to indicate the initial setting level.

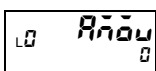

**B** Press the [MODE] Key several times to change the PV display to "Rñōu."

- This parameter is not displayed for the initial status due to setting level protect.

Refer to "5.34 Limiting Key Operations" for information on removing setting level protect.



**C** Press the [SHIFT] Key to make the SV display flash.

- The setting can be changed when the SV display starts to flash.

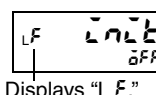

**D** Use the [UP] and [SHIFT] Keys to set the password "0159." Press the [MODE] Key to move to the advanced function setting level.

- "LF" is displayed on the level/bank display to indicate the advanced function setting level.

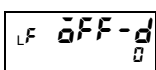

**E** Press the [MODE] Key several times to change the PV display to "ōFF-d."

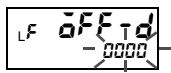

**F** Press the [SHIFT] Key to make the SV display flash.

- The setting can be changed when the SV display starts to flash.



**G** Use the [UP] and [SHIFT] Keys to change the set value.

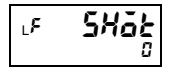

**H** Press the [MODE] Key to switch to the next parameter.

- The set value is registered.

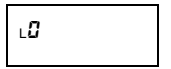

**I** Press the [LEVEL] Key for at least 1 s to return to the initial setting level.

1 s min.

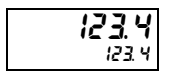

**J** Press the [LEVEL] Key for at least 1 s to return to RUN level.

1 s min.



"5.12 Outputting for a Set Interval" → P.5-45

"5.15 Holding Comparative Outputs" → P.5-50

## 5.14 Holding Measurement Status

R P C

Measurement values, maximum values, minimum values, and output status can be held while the HOLD input is ON.

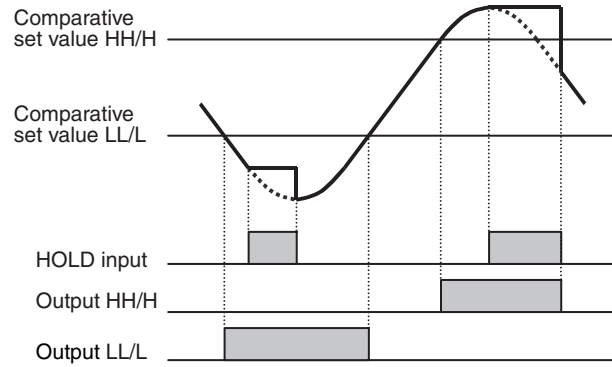

- The measurement value is held when the HOLD input turns ON.
- When the HOLD input turns OFF, the measurement value at that time is restored.
- During HOLD input, signals other than a RESET input or bank signal are not accepted.

# 5.15 Holding Comparative Outputs

Advanced function setting level



The comparative output hold function holds the status of all outputs except for the PASS output turns ON, i.e., it stops refreshing outputs. You can choose to stop outputs and continue measurement, or to stop both.

Outputs will be refreshed again after the reset operation.

- "5.7 Resetting Measurements" → P.5-34

### ● Example with Output Refresh Stop

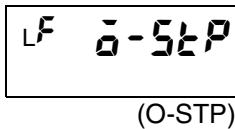
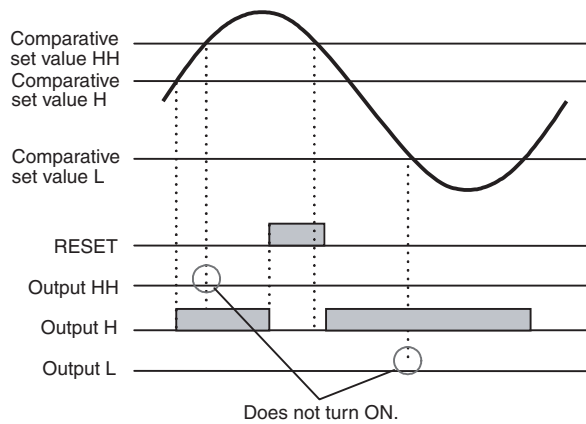

Parameter	Set value	Meaning of set value	
		Outputs	Measurement
Output refresh stop 0-5tP	0FF	Continue	Continue
	0Ut	Stop	Continue
	RLL	Stop	Stop

### Parameter Setting Procedure

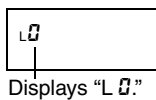

**A** Press the [LEVEL] Key for at least 3 s in RUN level to move to the initial setting level.

- "L 0" is displayed on the level/bank display to indicate the initial setting level.

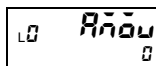

**B** Press the [MODE] Key several times to change the PV display to "R0000."

- This parameter is not displayed for the initial status due to setting level protect.
- Refer to "5.34 Limiting Key Operations" (P.5-85) for information on removing setting level protect.

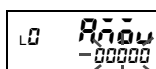

**C** Press the [SHIFT] Key to make the SV display flash.

- The setting can be changed when the SV display starts to flash.



LF LF  
Displays "LF."

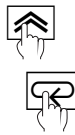

**D** Use the [UP] and [SHIFT] Keys to set the password "0159." Press the [MODE] Key to move to the advanced function setting level.

- "LF" is displayed on the level/bank display to indicate the advanced function setting level.

LF o-5tP  
OFF



**E** Press the [MODE] Key several times to change the PV display to "o-5tP."

LF o-5tP  
OFF 1



**F** Press the [SHIFT] Key to make the SV display flash.

- The setting can be changed when the SV display starts to flash.

LF o-5tP  
OFF 1



**G** Use the [UP] Key to change the set value.

LF bnM-1  
OFF



**H** Press the [MODE] Key to switch to the next parameter.

- The set value is registered.

LD



1 s min.

**I** Press the [LEVEL] Key for at least 1 s to return to the initial setting level.

123.4  
123.4



1 s min.

**J** Press the [LEVEL] Key for at least 1 s to return to RUN level.

## 5.16 Allocating Another Output to PASS Output

Advanced function setting level



The “PASS output change” parameter can be set to output a comparative output or error output from the PASS output terminal instead of outputting the PASS output. This function is valid only when there is a PASS output terminal.

In the default settings, PASS signals are output from the PASS output terminal.

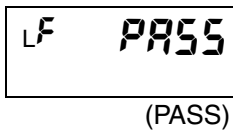

Parameter	Set value	Meaning of set value
PASS output change PASS	LL	LL
	L	L
	PASS	PASS
	H	H
	HH	HH

### Parameter Setting Procedure



Displays “L 0.”



3 s min.

**A** Press the [LEVEL] Key for at least 3 s in RUN level to move to the initial setting level.

- “L 0” is displayed on the level/bank display to indicate the initial setting level.

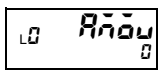

**B** Press the [MODE] Key several times to change the PV display to “P0000.”

- This parameter is not displayed for the initial status due to setting level protect.  
Refer to "5.34 Limiting Key Operations" (P.5-85) for information on removing setting level protect.

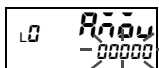

**C** Press the [SHIFT] Key to make the SV display flash.

- The setting can be changed when the SV display starts to flash.

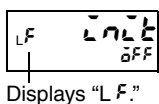

Displays “L F.”



**D** Use the [UP] and [SHIFT] Keys to set the password “- 0 159.” Press the [MODE] Key to move to the advanced function setting level.

- “L F” is displayed on the level/bank display to indicate the advanced function setting level.

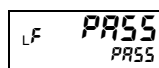

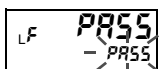

**E** Press the [MODE] Key to change the PV display to “PASS.”



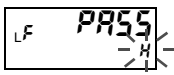

**F** Press the [SHIFT] Key to make the SV display flash.

- The setting can be changed when the SV display starts to flash.

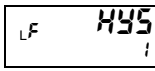

**G** Use the  [UP] Key to change the set value.



**H** Press the  [MODE] Key to switch to the next parameter.

- The set value is registered.



**I** Press the  [LEVEL] Key for at least 1 s to return to the initial setting level.

1 s min.

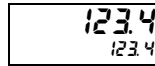

**J** Press the  [LEVEL] Key for at least 1 s to return to RUN level.

1 s min.

# 5.17 Reversing Output Logic

Advanced function setting level

R P C

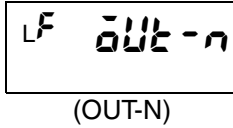

The output logic reversal function sets the logic of comparative outputs for comparative results.

Parameter	Set value	Operation		
		Comparative result	Comparative output status	Comparative output
Output logic OUT-N	Close in alarm n-a	ON	ON	ON
		OFF	OFF	OFF
	Open in alarm n-b	ON	ON	OFF
		OFF	OFF	ON

The comparative outputs will turn OFF if an input error occurs when "open in alarm" is set.

**Parameter Setting Procedure**



**A** Press the [LEVEL] Key for at least 3 s in RUN level to move to the initial setting level.

- "L0" is displayed on the level/bank display to indicate the initial setting level.

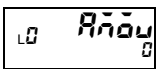

**B** Press the [MODE] Key several times to change the PV display to "Rnau."

- This parameter is not displayed for the initial status due to setting level protect. Refer to "5.34 Limiting Key Operations" (P.85) for information on removing setting level protect.

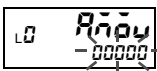

**C** Press the [SHIFT] Key to make the SV display flash.

- The setting can be changed when the SV display starts to flash.

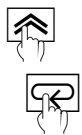
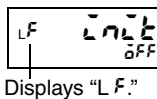

**D** Use the [UP] and [SHIFT] Keys to set the password "0159." Press the [MODE] Key to move to the advanced function setting level.

- "LF" is displayed on the level/bank display to indicate the advanced function setting level.

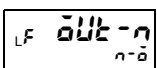

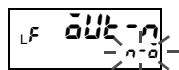

**E** Press the [MODE] Key several times to change the PV display to "OUT-N."



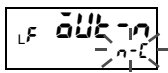

**F** Press the [SHIFT] Key to make the SV display flash.

- The setting can be changed when the SV display starts to flash.



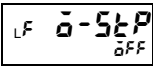

**G** Use the  [UP] Key to change the set value.

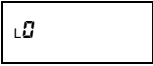

**H** Press the  [MODE] Key to switch to the next parameter.

- The set value is registered.



**I** Press the  [LEVEL] Key for at least 1 s to return to the initial setting level.

1 s min.

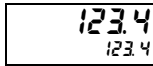

**J** Press the  [LEVEL] Key for at least 1 s to return to RUN level.

1 s min.

# 5.18 No Output before PASS Range

Advanced function setting level



The standby sequence function can be used to prevent outputs from turning ON for unstable inputs after the power is turned ON. All outputs will remain OFF until the measurement value reaches the PASS value.

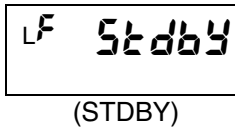
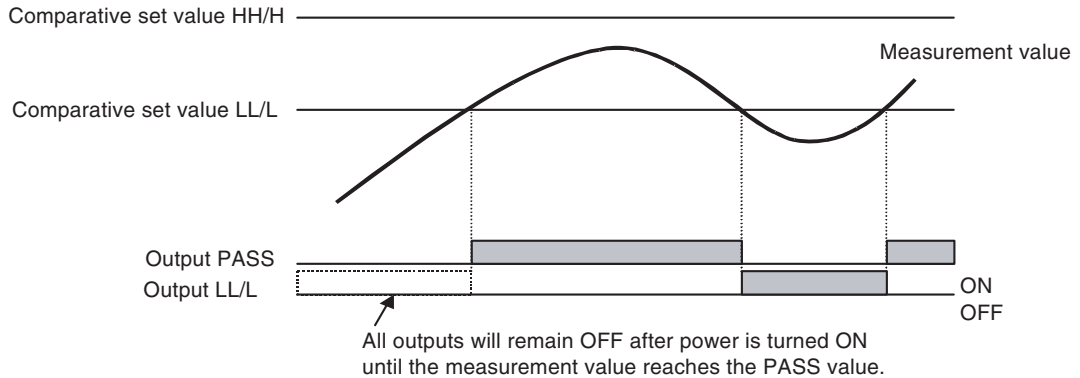

Parameter	Set value	Meaning of set value
Standby sequence StdbY	OFF	Disabled
	ON	Enabled

### Parameter Setting Procedure



**A** Press the [LEVEL] Key for at least 3 s in RUN level to move to the initial setting level.

- "L0" is displayed on the level/bank display to indicate the initial setting level.

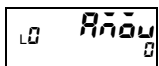

**B** Press the [MODE] Key several times to change the PV display to "Rn0u."

- This parameter is not displayed for the initial status due to setting level protect. Refer to "5.34 Limiting Key Operations" (P.5-85) for information on removing setting level protect.



**C** Press the [SHIFT] Key to make the SV display flash.

- The setting can be changed when the SV display starts to flash.

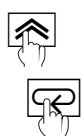
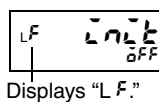

**D** Use the [UP] and [SHIFT] Keys to set the password "0159." Press the [MODE] Key to move to the advanced function setting level.

- "LF" is displayed on the level/bank display to indicate the advanced function setting level.



**E** Press the [MODE] Key several times to change the PV display to "StdbY."



**F** Press the [SHIFT] Key to make the SV display flash.

- The setting can be changed when the SV display starts to flash.



**G** Use the [UP] Key to change the set value to "ōn."

- Change the set value to "ōFF" to turn OFF the standby sequence.



**H** Press the [MODE] Key to switch to the next parameter.

- The set value is registered.



1 s min.

**I** Press the [LEVEL] Key for at least 1 s to return to the initial setting level.



1 s min.

**J** Press the [LEVEL] Key for at least 1 s to return to RUN level.

# 5.19 Performing Linear Output

Linear output level



The linear output function outputs currents or voltages proportional to measurement values as they change.

Select the type of linear output. Set the maximum and minimum output measurement values to output the current or voltage for those measurement values.

### Voltage Output

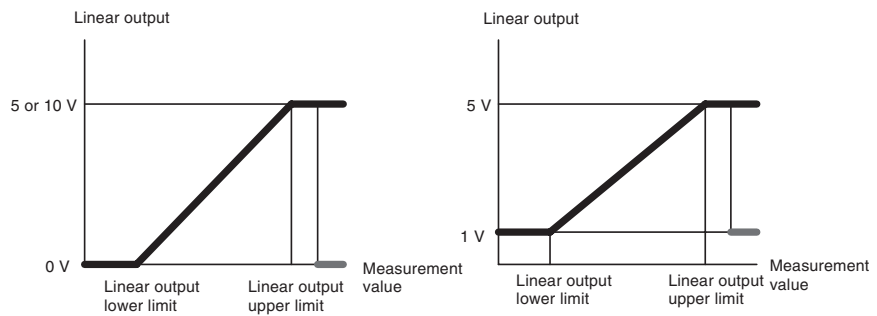

### Current Output

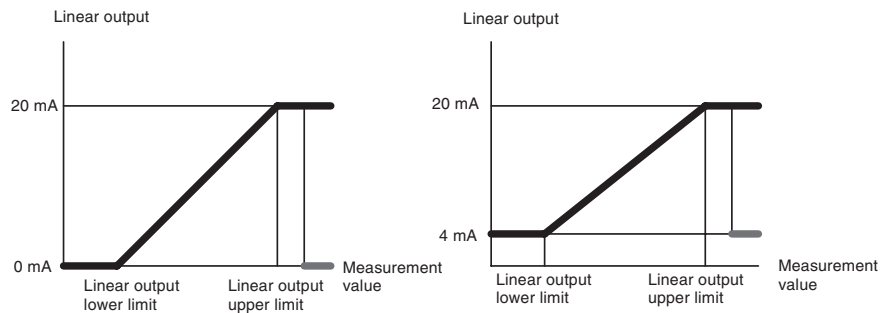

\* If operation stops without performing a measurement, then the minimum value (e.g., 4 mA for the 4 to 20 mA range) is output.

\* The value set for the upper limit does not necessarily have to be higher than the value set for the lower limit. The following is an example of reverse scaling.

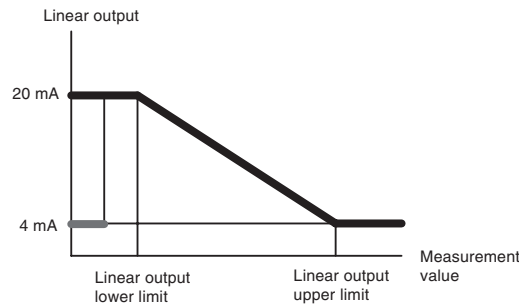

\* If the upper and lower limit are set to the same value, then the upper limit will equals the lower limit plus 1 for linear output.



L5 L5Et.C  
(LSET.C)

L5 L5Et.V  
(LSET.V)

L5 L5Et.H  
(LSET.H)

L5 L5Et.L  
(LSET.L)

Parameter	Set value	Meaning of set value
Linear current type L5Et.C	0-20	0 to 20 mA
	4-20	4 to 20 mA
Linear voltage type L5Et.V	0-5	0 to 5 V
	1-5	1 to 5 V
	0-10	0 to 10 V
Linear output upper limit L5Et.H	-19999 to 99999	-19999 to 99999
Linear output lower limit L5Et.L	-19999 to 99999	-19999 to 99999

\* When a linear output is mounted, the “linear current type” or “linear voltage type” parameter can be set according to the type of linear output.

With the K3HB-P, the setting range for the linear output lower limit value and the linear output upper limit value is 0 to 99999.

Input the upper and lower limits for the linear output as integer values. However, if the time unit for the K3HB-R/P is set to hr:min:s, the integer values will be interpreted as \*.\*.\* and if the time unit is set to min:s:ms, the integer values will be interpreted as \*\*.\*.\*.

**Parameter Setting Procedure**

L0  
Displays “L 0.”



**A** Press the [LEVEL] Key for at least 3 s in RUN level to move to the initial setting level.

- “L0” is displayed on the level/bank display to indicate the initial setting level.

L5 L5Et.C  
4-20  
Displays “L 5.”



**B** Press the [LEVEL] Key once (less than 1 s) or several times to move to the linear output level and display “L5Et.C.”

- “L5” is displayed on the level/bank display to indicate the linear output level.

L5 L5Et.C  
4-20



**C** Press the [SHIFT] Key to make the SV display flash.

- The setting can be changed when the SV display starts to flash.

L5 L5Et.C  
0-20



**D** Use the [UP] Key to change the set value.

L5 L5Et.H  
99999



**E** Press the [MODE] Key to switch to the next parameter.

- The set value is registered.

L5 L5Et.H  
99999



**F** Press the [SHIFT] Key to make the SV display flash.

- The setting can be changed when the SV display starts to flash.

L5 L5Et.H  
0 1000



**G** Use the [SHIFT] and [UP] Keys to change the linear output upper limit value.

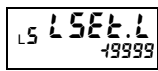

**H** Press the [MODE] Key to switch to the next parameter.

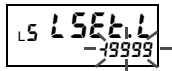

**I** Press the [SHIFT] Key to make the SV display flash.

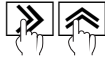

**J** Use the [SHIFT] and [UP] Keys to change the linear output lower limit value.



**K** Press the [MODE] Key to switch to the next parameter.

- The set values are registered.

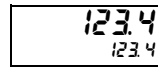

1 s min.

**L** Press the [LEVEL] Key for at least 1 s to return to RUN level.

## 5.20 Changing the Display Refresh Period

Display adjustment level

R P C

When measurement values change rapidly, the accompanying changes in the display value can cause flickering, decreasing readability. Readability of the display can be improved in such situations by lengthening the display refresh period to suppress flickering.

The display refresh period is set using the following parameter.

(D.REF)

Parameter	Set value	Meaning of set value
Display refresh period <i>d.rEF</i>	<i>0FF</i>	Every 50 ms
	<i>0.5</i>	Every 0.5 s
	<i>1</i>	Every 1 s
	<i>2</i>	Every 2 s
	<i>4</i>	Every 4 s

### Parameter Setting Procedure

Displays "L0."



**A** Press the [LEVEL] Key for at least 3 s in RUN level to move to the initial setting level.

- "L0" is displayed on the level/bank display to indicate the initial setting level.

Displays "L2."



**B** Press the [LEVEL] Key several times to move to the display adjustment level.

- "L2" is displayed on the level/bank display to indicate the adjustment level.

Displays "L2 d.rEF".



**C** Press the [MODE] Key to switch to the PV display to "d.rEF".

Displays "L2 d.rEF".



**D** Press the [SHIFT] Key to make the SV display flash.

- The setting can be changed when the SV display starts to flash.

Displays "L2 d.rEF".



**E** Use the [UP] Key to change the set value.

Displays "L2 00.0".



**F** Press the [MODE] Key to switch to the next parameter.

- The set value is registered.

Displays "123.4".



**G** Press the [LEVEL] Key for at least 1 s to return to RUN level.



"5.9 Averaging Input" → P.5-37

# 5.21 Setting a Compensation Value for the Measurement Value

Input adjustment level

C

This function sets the measurement value to the compensation value on the rising edge of the COMPENSATION input signal.

Compensation can be made conditional by selecting a compensation condition.

Explanation of Functions	Compensation, Compensation Conditions
--------------------------	---------------------------------------

By detecting the COMPENSATION rising edges, the measurement value can be set to the preset compensation value. Compensation of the measurement value can be specified to be performed only when the immediately preceding input is an incremental input by setting the compensation condition.

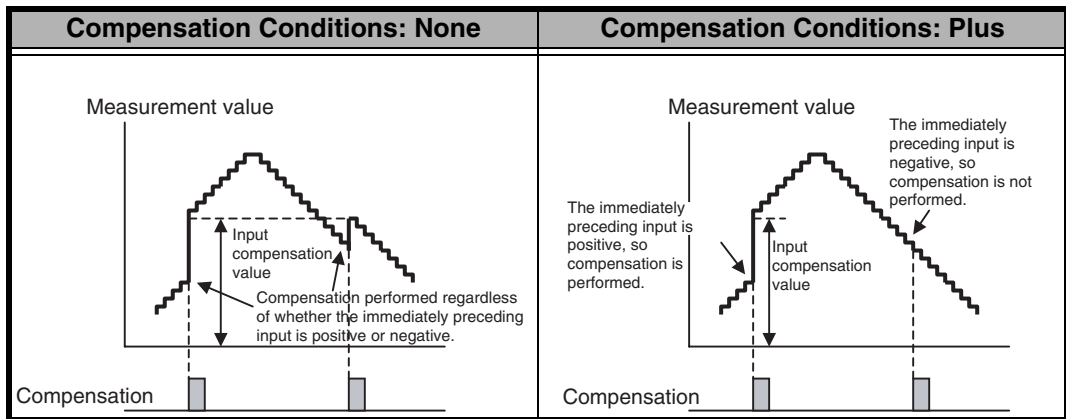

```
L1 [00Pn]
(COMPn)
```

Use the following parameter to set the compensation value.

Parameter	Set value	Meaning of set value
Compensation value [00Pn]	-9999 to 99999	-19999 to 99999

```
L1 [00-P]
(COM-P)
```

Use the following parameter to set the compensation condition.

Parameter	Set value	Meaning of set value
Compensation condition [00-P]	n0nE	No conditions
	PLUS	Enabled only when the immediately preceding input is an addition.

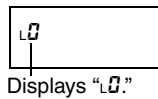
**Parameter Setting Procedure**

**A** Press the [LEVEL] Key for at least 3 s in RUN level to move to the initial setting level.

- "L0" is displayed on the level/bank display to indicate the initial setting level.

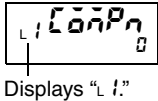

**B** Press the [LEVEL] Key several times to move to the input adjustment level.

- "L1" is displayed on the level/bank display to indicate the input adjustment level.



**C** Press the [SHIFT] Key to make the SV display flash.

- The setting can be changed when the SV display starts to flash.

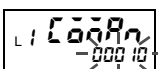

**D** Use the [UP] and [SHIFT] Keys to change the set value.



**E** Press the [MODE] Key to switch to the PV display to "L1-Comp-P".

The set value is registered.

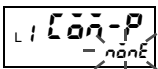

**F** Press the [SHIFT] Key to make the SV display flash.

- The setting can be changed when the SV display starts to flash.

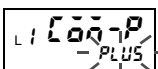

**G** Use the [UP] Key to change the set value.

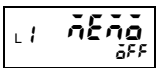

**H** Press the [MODE] Key to switch to the next parameter.

- The set value is registered.

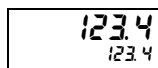

**I** Press the [LEVEL] Key for at least 1 s to return to RUN level.

## 5.22 Holding Measurement Values

Input adjustment level

C

This function holds measurement values in the event of a power interruption. You can specify that measurement values be held or not held.

This function can be used to control fluctuations in the measurement value even if the device momentarily stops.

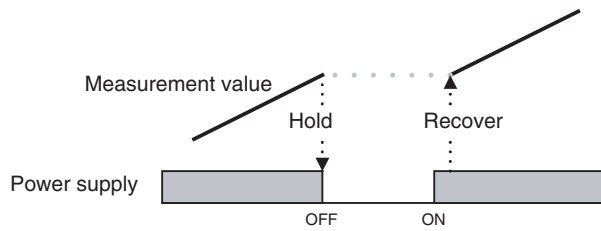

- \* Holds values even in overflow or no-measurement status.
- \* Holds values even if a software reset is performed by key operations or communications.
- \* The interruption memory cannot be accessed if the startup compensation timer is enabled when the power is turned ON.
- \* When the interruption memory is enabled, maximum and minimum values are also held when there is a power interruption. (This is also possible for the K3HB-R/P.)

Use the following parameter to set the interruption memory parameter.

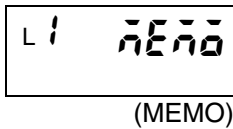

Parameter	Set value	Meaning of set value
Interruption memory āēāō	āā	Interruption memory enabled
	āFF	Interruption memory disabled

### Parameter Setting Procedure



**A** Press the [LEVEL] Key for at least 3 s in RUN level to move to the initial setting level.

- "L ā" is displayed on the level/bank display to indicate the initial setting level.

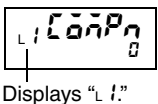

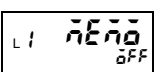

**B** Press the [LEVEL] Key several times to move to the input adjustment level.

- "L I" is displayed on the level/bank display to indicate the input adjustment level.



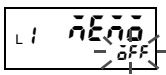

**C** Press the [MODE] Key to switch to the PV display to "āēāō".



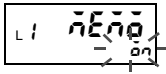

**D** Press the  [SHIFT] Key to make the SV display flash.

- The setting can be changed when the SV display starts to flash.



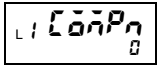

**E** Use the  [UP] Key to change the set value.

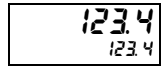

**F** Press the  [MODE] Key to switch to the next parameter.

- The set value is registered.



**G** Press the  [LEVEL] Key for at least 1 s to return to RUN level.

1 s min.



"5.23 Holding Maximum and Minimum Values" → P.5-66

## 5.23 Holding Maximum and Minimum Values

R P C

- Each time the  $\diamond$  [MAX/MIN] Key is pressed in the RUN level, the maximum or minimum value recorded while a measurement is being performed will be displayed.

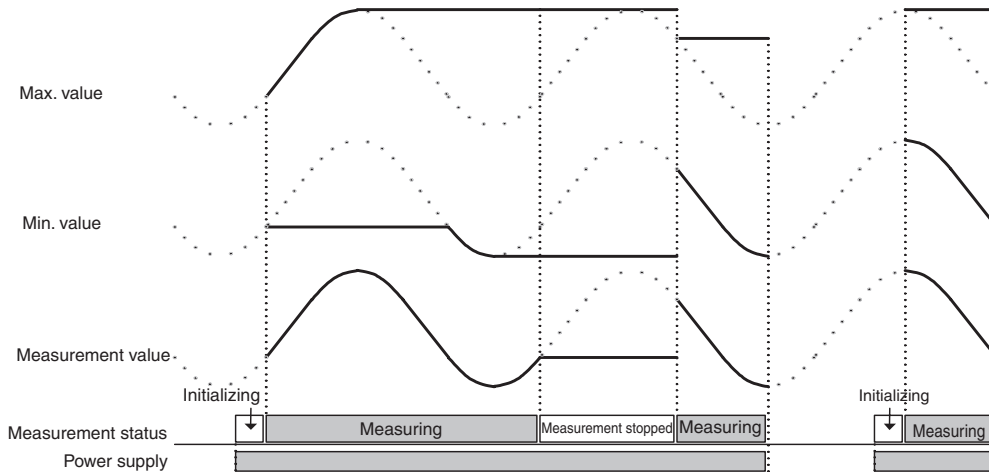

### ● Switching Maximum and Minimum Value Displays

Each time the  $\diamond$  [MAX/MIN] Key is pressed in the RUN level, the PV display switches as follows: present value → maximum value → minimum value → present value.

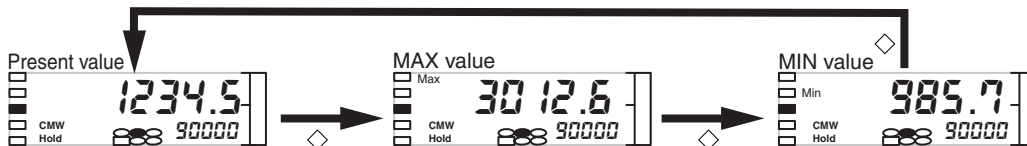

### ● Resetting the Maximum and Minimum Values

The maximum and minimum values can be reset by a RESET input or by pressing the  $\diamond$  [MAX/MIN] Key for 1 s.



### ● Maximum and Minimum Value Interruption Memory

This function can be used to hold the maximum and minimum values during power interruptions. The settings are hold and don't hold.

This function enables fluctuation management using the maximum and minimum values even if the device should momentarily stop.

\* "5.22 Holding Measurement Values" → P.5-64

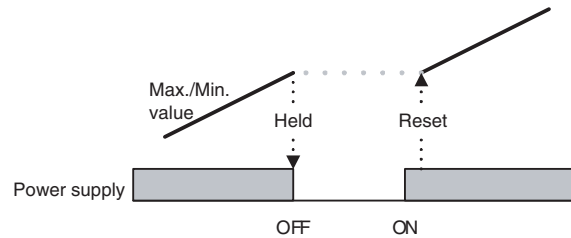

\* Values are held even in overflow or no-measurement status.

\* Values are held even if a software reset is performed by key operations or communications.

\* The interruption memory cannot be used if the startup compensation timer is enabled when the power is turned ON.



"5.22 Holding Measurement Values" → P.5-64

"5.24 Changing Normal Display Values to Maximum and Minimum Values" → P.5-68

# 5.24 Changing Normal Display Values to Maximum and Minimum Values

Display adjustment level

R P C

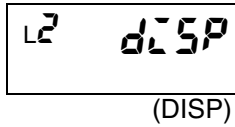

The PV display value displayed after power is turned ON, after a RESET input, immediately after moving to the RUN level, and immediately after automatic display return to the RUN or adjustment levels can be set to any of the following: present value, maximum value, or minimum value.

The display value selection is set using the following parameter.

Parameter	Set value	Meaning of set value
Display value selection dLSP	Pu	Present value
	nRu	Max. value
	nLn	Min. value

### Parameter Setting Procedure



Displays "L 0."



3 s min.

**A** Press the [LEVEL] Key for at least 3 s in RUN level to move to the initial setting level.

- "L 0" is displayed on the level/bank display to indicate the initial setting level.

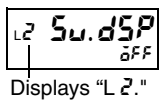

Displays "L 2."



**B** Press the [LEVEL] Key several times to move to the display adjustment level.

- "L 2" is displayed on the level/bank display to indicate the display adjustment level.

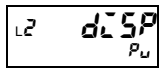

**C** Press the [MODE] Key to change the PV display to "dLSP."

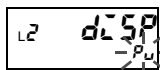

**D** Press the [SHIFT] Key to make the SV display flash.

- The setting can be changed when the SV display starts to flash.

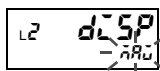

**E** Use the [UP] Key to change the set value.

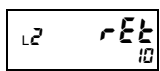

**F** Press the [MODE] Key to switch to the next parameter.

- The set value is registered.

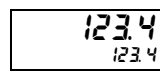

1 s min.

**G** Press the [LEVEL] Key for at least 1 s to return to RUN level.



"5.25 Displaying/Not Displaying Comparative Set Values" → P.5-69

"5.27 Using the Position Meter" → P.5-72

"5.28 Automatic Return to Normal Display" → P.5-74

## 5.25 Displaying/Not Displaying Comparative Set Values

Display adjustment level

R P C

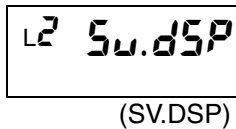

Comparative set values can be displayed or not displayed on the SV display during operation.

This is set using the following parameter.

Parameter	Set value	Meaning of set value
Comparative set value display Sv.dSP	OFF	Comparative set value not displayed.
	ON	Comparative set value displayed.

If “comparative set value display” is set to OFF, the comparative set value display will turn OFF (not be lit) after 10 s in RUN level. The comparative set value is displayed again when any key is pressed.

### Parameter Setting Procedure

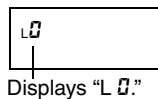

**A** Press the [LEVEL] Key for at least 3 s in RUN level to move to the initial setting level.

- “L0” is displayed on the level/bank display to indicate the initial setting level.

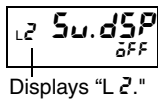

**B** Press the [LEVEL] Key several times to move to the display adjustment level.

- “L2” is displayed on the level/bank display to indicate the display adjustment level.

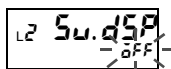

**C** Press the [SHIFT] Key to make the SV display flash.

- The setting can be changed when the SV display starts to flash.

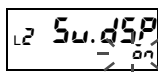

**D** Use the [UP] Key to change the set value.

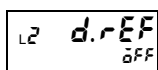

**E** Press the [MODE] Key to switch to the next parameter.

- The set value is registered.

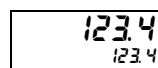

**F** Press the [LEVEL] Key for at least 1 s to return to RUN level.

## 5.26 Changing Display Colors

Display adjustment level

R P C

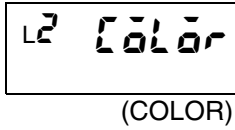

The PV display color can be switched when the comparative result changes from PASS to HH, H, L, or LL, or when an input error occurs during operation in RUN, adjustment, or protect levels.

This function is called “display color selection.” The color switching pattern is set using the following parameter.

Parameter	Set value	Status*	PV display color
Display color selection COLOR	Grn-r	OFF	Green
		ON	Red
	Grn	OFF	Green
		ON	
	rEd-G	OFF	Red
		ON	Green
	rEd	OFF	Red
		ON	

\* Comparative output HH, H, L, or LL or input error status

K3HB-R/P:

OFF: All comparative outputs HH, H, L, and LL are OFF and no input error.

ON: HH, H, L, or LL comparative output is ON or input error.

K3HB-C:

OFF: All outputs 1 to 5 are OFF and no input error.

ON: One of outputs 1 to 5 is ON or input error.

### Parameter Setting Procedure



**A** Press the [LEVEL] Key for at least 3 s in RUN level to move to the initial setting level.

- "L 0" is displayed on the level/bank display to indicate the initial setting level.

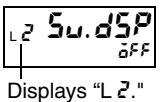

**B** Press the [LEVEL] Key several times to move to the display adjustment level.

- "L 2" is displayed on the level/bank display to indicate the display adjustment level.

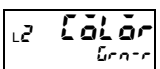

**C** Press the [MODE] Key to change the PV display to "COLOR."

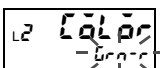

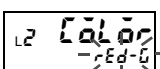

**D** Press the [SHIFT] Key to make the SV display flash.

- The setting can be changed when the SV display starts to flash.



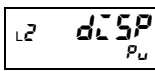

**E** Use the [UP] Key to change the set value.

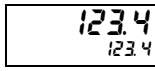

**F** Press the  [MODE] Key to switch to the next parameter.

- The set value is registered.



**G** Press the  [LEVEL] Key for at least 1 s to return to RUN level.

1 s min.



"5.29 Performing Output Tests" → P.5-75

## 5.27 Using the Position Meter

Display adjustment level

R P C

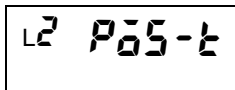

(POS-T)

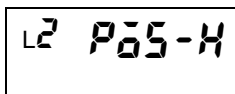

(POS-H)

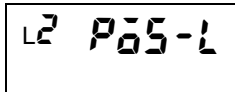

(POS-L)

The meter on the right side of the front panel with 20 sections is called the “position meter” and shows the position of the displayed value (present value, maximum, or minimum) in relation to any values set using the position meter upper and lower limits. The position meter upper and lower limits can be set to any range.

The position meter display pattern is set using the following parameter.

Parameter	Set value	Meaning of set value
Position meter type <i>POS-t</i>	OFF	OFF
	INC	Incremental
	INC-r	Incremental (reversed)
	DEV	Deviation (*2)
	DEV-r	Deviation (reversed)
Position meter upper limit <i>POS-H</i>	-9999 to 99999	-19999 to 99999 (*1)
Position meter lower limit <i>POS-L</i>	-9999 to 99999	-19999 to 99999 (*1)

\*1. The decimal point depends on the “decimal point position” parameter setting.

With the K3HB-P, the setting range is 0 to 99999.

\*2. The amount that the displayed value differs from the mid-point between the position meter upper and lower limits (the deviation) is displayed.

Position meter type	Incremental	Incremental (reversed)	Deviation	Deviation (reversed)
Position meter upper limit (set to 100)				
Position meter lower limit (set to 0)				

\* If the position meter lower limit set value is larger than the position meter upper limit set value, the top and bottom of the above displays will be reversed.

\* The position meter will not be lit if there is an input error.

**Parameter Setting Procedure**



**A** Press the [LEVEL] Key for at least 3 s in RUN level to move to the initial setting level.

- "L0" is displayed on the level/bank display to indicate the initial setting level.

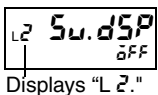

**B** Press the [LEVEL] Key several times to move to the display adjustment level.

- "L2" is displayed on the level/bank display to indicate the display adjustment level.

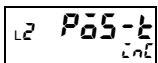

**C** Press the [MODE] Key several times to change the PV display to "P05-t."

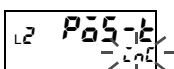

**D** Press the [SHIFT] Key to make the SV display flash.

- The setting can be changed when the SV display starts to flash.

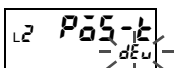

**E** Use the [UP] Key to change the position meter type setting.

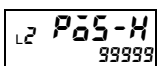

**F** Press the [MODE] Key to switch to the next parameter "P05-H."

- The parameter for position meter type is registered.

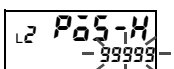

**G** Press the [SHIFT] Key to make the SV display flash.

- The setting can be changed when the SV display starts to flash.

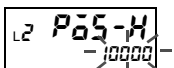

**H** Use the [UP] and [SHIFT] Keys to change the position meter upper limit setting.

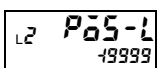

**I** Press the [MODE] Key to switch to the next parameter "P05-L."

- The parameter for the position meter upper limit is registered.

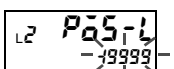

**J** Press the [SHIFT] Key to make the SV display flash.

- The setting can be changed when the SV display starts to flash.



**K** Use the [UP] and [SHIFT] Keys to change the position meter lower limit setting.

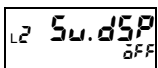

**L** Press the [MODE] Key to switch to the next parameter.

- The parameter for the position meter lower limit is registered.

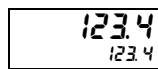

**M** Press the [LEVEL] Key for at least 1 s to return to RUN level.

## 5.28 Automatic Return to Normal Display

Display adjustment level

R P C

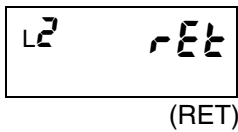

If no keys operations are performed for a specified time in the RUN level or adjustment level, the display will automatically return to the display status activated when the power was turned ON. The time until the display returns automatically can be set and the automatic display return can be disabled through this setting.

Automatic display return settings are made using the following parameter.

Parameter	Set value	Meaning of set value
Automatic display return rEt	0 to 99	0 to 99 s Automatic display return will not occur if set to 0.

### Parameter Setting Procedure



**A** Press the [LEVEL] Key for at least 3 s in RUN level to move to the initial setting level.

- "L 0" is displayed on the level/bank display to indicate the initial setting level.

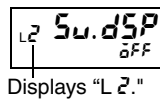

**B** Press the [LEVEL] Key several times to move to the display adjustment level.

- "L 2" is displayed on the level/bank display to indicate the display adjustment level.

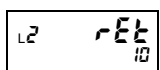

**C** Press the [MODE] Key several times to change the PV display to "rEt."

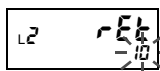

**D** Press the [SHIFT] Key to make the SV display flash.

- The setting can be changed when the SV display starts to flash.

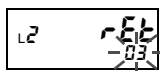

**E** Use the [UP] and [SHIFT] Keys to change the set value.

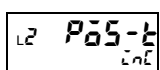

**F** Press the [MODE] Key to switch to the next parameter.

- The set value is registered.

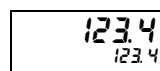

**G** Press the [LEVEL] Key for at least 1 s to return to RUN level.



## 5.29 Performing Output Tests

Output test level

R P C

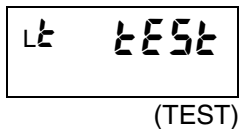

The output test function is used to set test measurement values using the keys to check the comparative outputs against the set comparative set values.

A test measurement value is set using the following parameter.

Parameter	Set value	Meaning of set value
Test input t E S t	o F F	Output test disabled
	-99999 to 99999	-19999 to 99999 (See note.)

Note: With the K3HB-P, the setting range is 0 to 99999.

### Parameter Setting Procedure

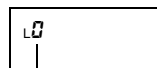

Displays "L o."



3 s min.

**A** Press the [LEVEL] Key for at least 3 s in RUN level to move to the initial setting level.

- "L o" is displayed on the level/bank display to indicate the initial setting level.

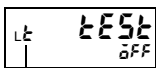

Displays "L t."



**B** Press the [LEVEL] Key several times to move to the output test level "t E S t."

- "L t" is displayed on the level/bank display to indicate the output test level.

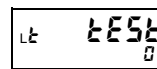

**C** Press the [SHIFT] Key.

- The test input will be 0 after moving to output test status.

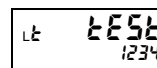

**D** Use the [UP] and [SHIFT] Keys to change the set value.

- Use the [UP] Key to increase the set value.
- Use the [SHIFT] Key to decrease the set value.
- Continue pressing the key to quickly increase or decrease the set value.

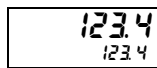

1 s min.

**E** Once the output test has finished, press the [LEVEL] Key for at least 1 s to return to RUN level.

## 5.30 Using Prescale/Comparative Set Value Banks

Advanced function setting level/Prescale level/Comparative set value level

R P C

The K3HB has 8 banks where groups of prescale values and comparative set values can be set in advance. Prescale values and comparative set values can be changed easily by switching these banks. This function is called “bank selection.”

Explanation of Functions	Bank selection
--------------------------	----------------

Prescale values AX, AY, BX, and BY and comparative set values HH, H, L, and LL (5, 4, 3, 2, and 1) are set into banks. Prescale values and comparative set values can be set to all 8 banks, numbered 0 to 7. Banks can be selected using front panel keys or an event input.

\* If the bank copy function is used, the prescale values or comparative set values set to one bank can be copied to all banks.

### 1. Specifying the Bank Selection Method

Before banks can be selected, the bank selection method must be specified. The bank selection function is enabled when the selection method is specified. The individual bank settings cannot be made until bank selection is enabled.

The bank selection method is set using the following parameter.

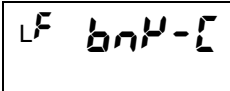

(BNK-C)

Applicable models:

K3HB-□□□-□□2

K3HB-□□□-□□4

Parameter	Set value	Meaning of set value
Bank selection <i>bnk-C</i>	OFF	Bank selection disabled
	KEY	Bank selection using keys (*1)
	EW	Bank selection using event input (*2)

\*1. With this setting, banks cannot be selected using event inputs.

\*2. With this setting, banks cannot be selected using key operations.

Event inputs can be used only for models with connectors.

The relationship between event input (BANK1, BANK2, and BANK4) ON/OFF status and the bank number is shown below.

Bank No.	External terminals		
	BANK1	BANK2	BANK4
0	OFF	OFF	OFF
1	ON	OFF	OFF
2	OFF	ON	OFF
3	ON	ON	OFF
4	OFF	OFF	ON
5	ON	OFF	ON
6	OFF	ON	ON
7	ON	ON	ON

### Parameter Setting Procedure



**A** Press the [LEVEL] Key for at least 3 s in RUN level to move to the initial setting level.

- "L0" is displayed on the level/bank display to indicate the initial setting level.



**B** Press the [MODE] Key several times to change the PV display to "R0000."

- This parameter is not displayed for the initial status due to setting level protect.
- Refer to "5.34 Limiting Key Operations" (P.5-85) for information on removing setting level protect.



**C** Press the [SHIFT] Key to make the SV display flash.

- The setting can be changed when the SV display starts to flash.

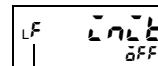

Displays "LF."



**D** Use the [UP] and [SHIFT] Keys to set the password "0159." Press the [MODE] Key to move to the advanced function setting level.

- "LF" is displayed on the level/bank display to indicate the advanced function setting level.

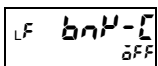

**E** Press the [MODE] Key several times to change the PV display to "b00-L."

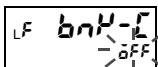

**F** Press the [SHIFT] Key to make the SV display flash.

- The setting can be changed when the SV display starts to flash.

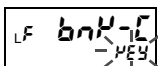

**G** Use the [UP] Key to change the set value.

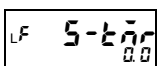

**H** Press the [MODE] Key to switch to the next parameter.

- The set value is registered.

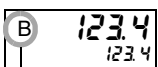

B lights.



**I** Press the [LEVEL] Key for at least 1 s to return to RUN level.

- "B" lights to indicate that the banks are enabled.

## 2. Setting Prescale Values for Each Bank

L3 PS.BNK

(PS.BNK)

L3 PS\*.A $\bar{u}$

(PS\*.AX)

L3 PS\*.AY

(PS\*AY)

L3 PS\*.b $\bar{u}$

(PS\*BX)

L3 PS\*.b $\bar{y}$

(PS\*BY)

L3 dP\*

(DP\*)

L3 COPY

(COPY)

Use the following parameter to set the prescale values.

Parameter	Set value	Meaning of set value
Input A Prescale value *X PS*.A $\bar{u}$	0.0000 to 9.9999	Input A prescale value (mantissa)
Input A Prescale value *Y PS*.AY	-9 to 9	Input A prescale value (exponent)
Input B Prescale value *X PS*.b $\bar{u}$	0.0000 to 9.9999	Input B prescale value (mantissa)
Input B Prescale value *Y PS*.b $\bar{y}$	-9 to 9	Input B prescale value (exponent)

\* Bank number: 0 to 7

Parameter	Set value	Meaning of set value
Decimal point position* dP*	00000	No decimal point
	0000.0	One digit below the decimal point is displayed.
	000.00	Two digits below the decimal point are displayed.
	00.000	Three digits below the decimal point are displayed.
	0.0000	Four digits below the decimal point are displayed.

\* Bank number: 0 to 7

### 3. Setting Comparative Set Values for Each Bank

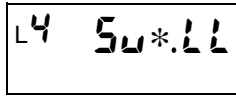
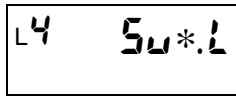
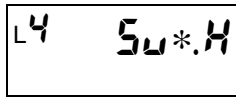
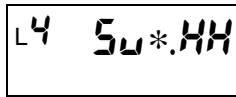
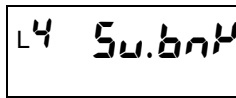

\* 0 to 7

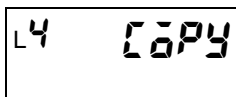

Once the bank selection method has been specified, set the comparative set values for each bank.

#### ● K3HB-R/P

Parameter	Set value	Meaning of set value
Comparative set value* HH SV*.HH	<del>19999</del> to 99999	-19999 to 99999
Comparative set value* H SV*.H	<del>19999</del> to 99999	-19999 to 99999
Comparative set value* L SV*.L	<del>19999</del> to 99999	-19999 to 99999
Comparative set value* LL SV*.LL	<del>19999</del> to 99999	-19999 to 99999

\* Bank number: 0 to 7

**Note:** The decimal point depends on the “decimal point position” parameter setting.

With the K3HB-P, the setting range is 0 to 99999.

#### ● K3HB-C

Parameter	Set value	Meaning of set value
Comparative set value* 5 SV*.d5	<del>19999</del> to 99999	-19999 to 99999
Comparative set value* 4 SV*.d4	<del>19999</del> to 99999	-19999 to 99999
Comparative set value* 3 SV*.d3	<del>19999</del> to 99999	-19999 to 99999
Comparative set value* 2 SV*.d2	<del>19999</del> to 99999	-19999 to 99999
Comparative set value* 1 SV*.d1	<del>19999</del> to 99999	-19999 to 99999

\* Bank number: 0 to 7

**Note:** The decimal point depends on the “decimal point position” parameter setting.

#### Parameter Setting Procedure

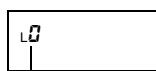

**A** Press the [LEVEL] Key for at least 3 s in RUN level to move to the initial setting level.

- "L0" is displayed on the level/bank display to indicate the initial setting level.

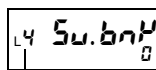

**B** Press the [LEVEL] Key several times to move to the comparative set value level.

- "L4" is displayed on the level/bank display to indicate the comparative set value level.

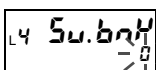

**C** Press the [SHIFT] Key to make the SV display flash.

- The setting can be changed when the SV display starts to flash.

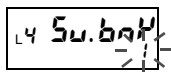

**D** Use the [UP] Key to select the bank to be set.

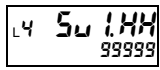

**E** Press the [MODE] Key.

• The bank selected in step D can be set.

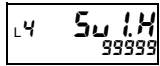

**F** Press the [MODE] Key several times to select the comparative set value to be changed.

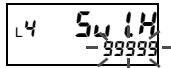

**G** Press the [SHIFT] Key to make the SV display flash.

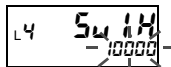

**H** Use the [UP] and [SHIFT] Keys to change the set value.

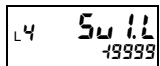

**I** Press the [MODE] Key to switch to the next parameter.

• The parameter changed in step H is registered.

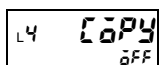
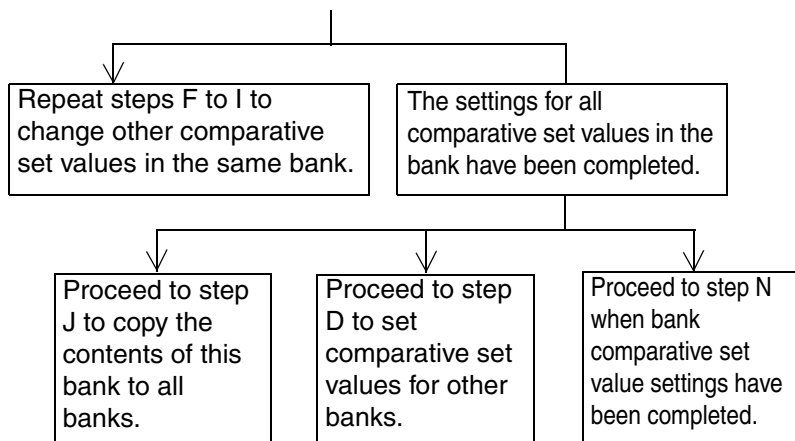

**J** Press the [MODE] Key several times to change the PV display to "COPY."

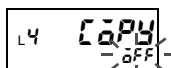

**K** Press the [SHIFT] Key to make the SV display flash.

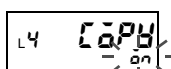

**L** Use the [UP] Key to change the set value.

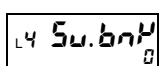

**M** Press the [MODE] Key to switch to the next parameter "Su.bank."

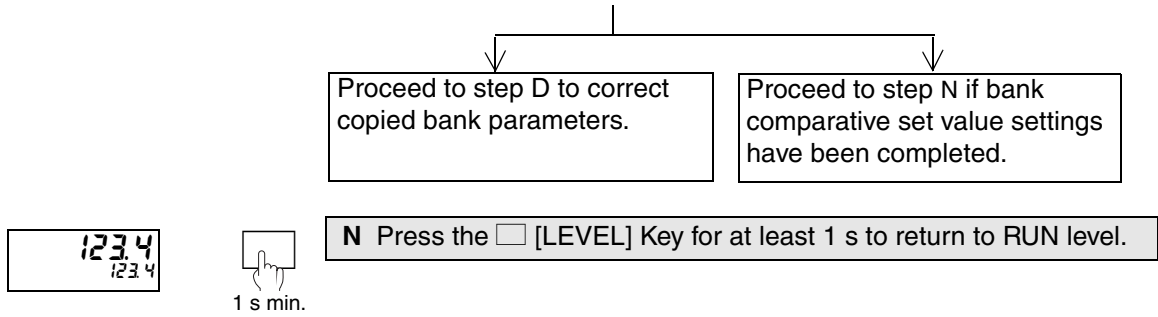

"5.32 Copying Bank Comparative Set Values" → P.5-83

## 5.31 Copying Bank Prescale Values

Prescale level

R P C

(COPY)

The bank copy function is used to specify a bank between 0 and 7 and copy the group of prescale values in that bank to all banks.

Displays "L 0."



3 s min.

**A** Press the [LEVEL] Key for at least 3 s in RUN level to move to the initial setting level.

- "L 0" is displayed on the level/bank display to indicate the initial setting level.

Displays "L 3."



**B** Press the [LEVEL] Key several times to move to the comparative set value level.

- "L 3" is displayed on the level/bank display to indicate the comparative set value level.



**C** Press the [SHIFT] Key to make the SV display flash.

- The setting can be changed when the SV display starts to flash.



**D** Use the [UP] Key to select the bank to be copied from.



**E** Press the [MODE] Key to switch to the next parameter.

- Change the prescale values AX, AY, BX, and BY as required.



**F** Press the [MODE] Key several times to change the PV display to "COPY."



**G** Press the [SHIFT] Key to make the SV display flash.

- The setting can be changed when the SV display starts to flash.



**H** Use the [UP] Key to change the SV display to "00."



**I** Press the [MODE] Key to switch to the next parameter.

- The prescale value from the copy source bank selected in step D will be copied to all banks.



## 5.32 Copying Bank Comparative Set Values

Comparative set value

R P C

(COPY)

The bank copy function is used to specify a bank between 0 and 7 and copy the group of comparative set values in that bank to all banks.

### Parameter Setting Procedure

Displays "L 0."



3 s min.

**A** Press the [LEVEL] Key for at least 3 s in RUN level to move to the initial setting level.

- "L 0" is displayed on the level/bank display to indicate the initial setting level.

Displays "L 4."



**B** Press the [LEVEL] Key several times to move to the comparative set value level.

- "L 4" is displayed on the level/bank display to indicate the comparative set value level.



**C** Press the [SHIFT] Key to make the SV display flash.

- The setting can be changed when the SV display starts to flash.



**D** Use the [UP] Key to select the bank to be copied from.



**E** Press the [MODE] Key to switch to the next parameter.

- Change the comparative set values HH, H, L, and LL as required.



**F** Press the [MODE] Key several times to change the PV display to "COPY."



**G** Press the [SHIFT] Key to make the SV display flash.

- The setting can be changed when the SV display starts to flash.



**H** Use the [UP] Key to change the SV display to "00."



**I** Press the [MODE] Key to switch to the next parameter.

- The comparative set value from the copy source bank selected in step D will be copied to all banks.

## 5.33 Initializing All Settings

Advanced function setting level

R P C

### Important \*

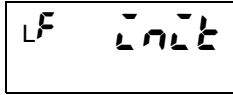

(INIT)



Displays "L 0."



3 s min.

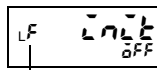
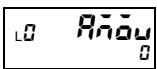

Displays "L F."

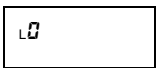
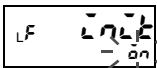
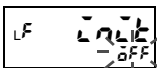

1 s min.

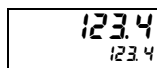

1 s min.

Initialization can be used to start settings over again from the default settings. Refer to "Parameter List" (P.A-8) for information on default set values.

### Parameter Setting Procedure

**A** Press the [LEVEL] Key for at least 3 s in RUN level to move to the initial setting level.

- "L 0" is displayed on the level/bank display to indicate the initial setting level.

**B** Press the [MODE] Key several times to change the PV display to "P 0.0."

- This parameter is not displayed for the initial status due to setting level protect.  
Refer to "5.34 Limiting Key Operations" (P.5-85) for information on removing setting level protect.

**C** Press the [SHIFT] Key to make the SV display flash.

- The setting can be changed when the SV display starts to flash.

**D** Use the [UP] and [SHIFT] Keys to set the password "0 159." Press the [MODE] Key to move to the advanced function setting level.

- "L F" is displayed on the level/bank display to indicate the advanced function setting level.

**E** Press the [SHIFT] Key to make the SV display flash.

- The setting can be changed when the SV display starts to flash.

**F** Use the [UP] Key to change the SV display to "0.0."

**G** Press the [MODE] Key to switch to the next parameter and execute initialization.

- The set value is registered.

**H** Press the [LEVEL] Key for at least 1 s to return to the initial setting level.

**I** Press the [LEVEL] Key for at least 1 s to return to RUN level.

\* If this operation is performed, all parameters return to the initial settings and current settings are lost. It is recommended that before performing this operation, the Parameter List at the end of this manual or some other method is used to record the current set values.

## 5.34 Limiting Key Operations

Protect level

R P C

The key protect function limits level and parameter changes using key operations. There are four kinds of key protection. The parameters, settings and details on the limitations of each kind of protection are outlined below.

○: Enabled, ✕: Prohibited

### ● RUN/Adjustment Protect

The following parameter limits key operations in RUN level and movement to adjustment level.

LP rUn.Pt

(RUN.PT)

LP SEt.Pt

(SET.PT)

LP yL.Pt

(WT.PT)

LP āā.Pt

(MM.PT)

Parameter	Set value	Restriction details		
		RUN level		Move to the adjustment level
		Present value display	Comparative set value change	
RUN/adjustment protect rUn.Pt	0	○	○	○ (See note.)
	1	○	○	✕
	2	○	✕	✕

**Note:** When there are no enabled menu items on the adjustment level (i.e., when bank selection is at a setting other than “Key” and there is no communications function), movement to the adjustment level is not possible.

### ● Setting Level Protect

The following parameter limits moving to other levels.

Parameter	Set value	Restriction details	
		Move to the initial setting level	Move to the advanced function setting level
Setting level protect SEt.Pt	0	○	○
	1	○	✕
	2	✕	✕

### ● Setting Change Protect

The following parameter disables changing settings with key operations.

Parameter	Set value	Restriction details
Setting change protect yL.Pt	āāā	Setting change using key operations: Enabled
	āā	Setting change using key operations: Prohibited

\* All protect level parameters and movement to the advanced function setting level and calibration level can be changed.

● **Max/Min Protect**

The following parameter limits key operations for switching and resetting maximum and minimum values.

Parameter	Set value	Max./min. value switching	Reset
Max/Min protect āā.Pt	0	Enabled	Enabled
	1	Enabled	Prohibited
	2	Prohibited	Prohibited

**Parameter Setting Procedure**

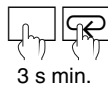
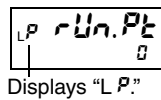

**A** Press the [LEVEL] and [MODE] Keys together for at least 3 s in RUN level to move to the protect level.

- "L.P." is displayed on the level/bank display to indicate protect level.

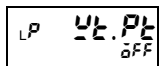

**B** Press the [MODE] Key several times to display the desired protection.

- The display shows setting change protect as an example.



**C** Press the [SHIFT] Key to make the SV display flash.

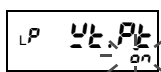

**D** Use the [UP] Key to change the SV display.



**E** Press the [MODE] Key to switch to the next parameter.

- The set value is registered.

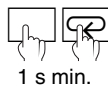
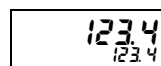

**F** Press the [LEVEL] and [MODE] Keys together for at least 1 s to return to RUN level.

# Section 6 *Troubleshooting*

6.1 Error Displays .....	6-2
6.2 Countermeasures .....	6-3

## 6.1 Error Displays

PV display	SV display	Description of error		Countermeasure
Unit	Err	An unexpected Unit was detected.		The mounting position depends on the Unit model. Check the Unit's model number and mount it in the correct position.
Unit	CHK	Displayed the first time power is turned ON after mounting a new Unit.		Press the <input type="checkbox"/> [LEVEL] Key for at least 3 s to register the new Unit configuration.
dLSP	Err	Display error		Repair is necessary. Consult your OMRON representative.
SYS	Err	Internal memory error	A SYSERR message displayed when there is no pulse input indicates an internal memory error.	Repair is necessary. Consult your OMRON representative.
		Input frequency range exceeded error		
EEP	Err	Error in non-volatile memory		Press the <input type="checkbox"/> [LEVEL] Key in this state for at least 3 s to return to the factory settings. If the problem still persists, repair is necessary. Contact the point of purchase or your OMRON representative.
Flashing on 99999 or -9999	Normal operation	The measurement value after scaling is either greater than 99,999 or less than -19,999.		Operation will continue with a measurement value of 99,999 or -19,999. If there is an operating problem, adjust the input range and scaling value until the measurement value falls within the range.
				The scaling value may be inappropriate. Review the scaling value in the initial setting level.

- \*1. The parameters already set are returned to the factory settings.  
If the problem still persists after performing initialization, repair is necessary.

## 6.2 Countermeasures

Symptoms	Inspection details	Countermeasure
The display remains on “-----” after the power is turned ON.	Is the “startup compensation timer” setting too long?	The “startup compensation timer” can be set up to 99.9 s. Change the setting to an appropriate value.
	Is the HOLD input still ON?	Turn OFF the HOLD input. If the HOLD input remains ON and the power is turned ON, the display remains on “-----” while the HOLD input remains ON.
	Is the RESET input still ON?	Turn OFF the RESET input.
The comparative output does not turn OFF even if the measurement value returns to the normal range.	Is the hysteresis setting too large?	Change the setting to an appropriate value.
	Is the Output Refresh Stop set?	Turn OFF the Output Refresh Stop.
Cannot move to the advanced function setting level.	Is the operation protected?	Refer to Advanced Function Setting Level for information on how to clear protection.→ P.5-4





# Appendices

Specifications.....	A-2
Model Number Structure.....	A-7
Parameter List.....	A-8
Parameter Display Conditions .....	A-17
About Parameters .....	A-23
“No-Measurement” Status .....	A-29
Forecasted Cycle Calculations .....	A-30

# Specifications

## ■ Ratings

<b>Power supply voltage</b>		100 to 240 VAC, 24 VAC/VDC, DeviceNet power supply: 24 VDC
<b>Allowable power supply voltage range</b>		85% to 110% of the rated power supply voltage DeviceNet power supply: 11 to 25 VDC
<b>Power consumption (at maximum load)<sup>*1</sup></b>		100 to 240 VAC: 18 VA max., 24 VAC/VDC: 11 VA/7 W max.
<b>Current consumption</b>		DeviceNet power supply: 50 mA max. (24VDC)
<b>Inputs</b>		No-voltage contact, voltage pulse, open collector
<b>External power supply</b>		12 VDC ± 10% 80 mA (only for models with external power supply) 10 VDC ± 5% 100 mA (only for models with external power supply)
<b>Event inputs<sup>*2 *4</sup></b>	<b>Startup compensation timer input</b>	NPN open collector or no-voltage contact signal ON residual voltage: 2 V max. ON current at 0 Ω: 4 mA max. Max. applied voltage: 30 VDC max. OFF leakage current: 0.1 mA max.
	<b>Hold input</b>	
	<b>Reset input</b>	
	<b>Compensation input</b>	
	<b>Bank input</b>	
<b>Outputs<sup>*4</sup></b>	<b>Relay contact outputs</b>	250 VAC, 30 VDC, 5 A (resistive load) Mechanical life expectancy: 5,000,000 operations, Electrical life expectancy: 100,000 operations
	<b>Transistor outputs</b>	Maximum load voltage: 24 VDC, Maximum load current: 50 mA, Leakage current: 100 μA max.
	<b>Linear outputs</b>	0 to 20 mA DC, 4 to 20 mA: Load: 500 Ω max, Resolution: Approx. 10,000, Output error: ±0.5% FS 0 to 5 VDC, 1 to 5 VDC, 0 to 10 VDC Load: 5 kΩ max, Resolution: Approx. 10,000, Output error: ±0.5% FS (but ±0.15 V, 0 V for 1 V or less)
<b>Display method</b>		<ul style="list-style-type: none"> <li>Negative LCD (backlit LCD) display</li> <li>7-segment digital display (Character height: PV: 14.2 mm (green/red); SV: 4.9 mm (green))</li> </ul>
<b>Main functions<sup>*4</sup></b>		Scaling, measurement operation selection, average processing, previous average comparison, output hysteresis, output ON delay, output test, teaching, display selection, display color switching, key protection, bank selection, display refresh period, maximum/minimum hold, reset
<b>Ambient operating temperature</b>		-10 to 55°C (with no icing or condensation)
<b>Ambient operating humidity</b>		25% to 85%
<b>Storage temperature</b>		-25 to 65°C (with no icing or condensation)
<b>Altitude</b>		2,000 m max.
<b>Accessories</b>		Waterproof packing, 2 fixtures, terminal cover, unit stickers, instruction manual, DeviceNet connector (DeviceNet models only, Hirose HR31-5.08P-5SC (01)), crimp terminals (DeviceNet models only, Hirose HR31-SC-121) <sup>*3</sup>

\*1 For models with DC power supply, approximately 1 A of control power supply capacity is required for each Digital Indicator. Be sure there is adequate power supply capacity when using more than one Digital Indicator. We recommend the S8VS DC Power Supply from OMRON.

\*2 Models with PNP inputs are also available.

\*3 Only the enclosed DeviceNet connector can be used with K3HB models with DeviceNet communications. The enclosed crimp terminals are for Thin Cable.

\*4 Depends on the model.

## ■ Characteristics

### K3HB-R

<b>Display range</b>	-19,999 to 99,999	
<b>Measurement accuracy (at 23±5°C)</b>	Functions F1, F6: ±0.006% rdg ±1 digit (for voltage pulse/open collector sensors) Functions F2 to F5: ±0.02% rdg ±1 digit (for voltage pulse/open collector sensors)	
<b>Measurement range</b>	Functions F1 to F6: 0.5 mHz to 50 kHz (for voltage pulse/open-collector sensors)	
<b>Input signals</b>	No-voltage contact (30-KHz max. with ON/OFF pulse width of 15 ms min.) Voltage pulse (50-KHz max. with ON/OFF pulse width of 9 µs min.; ON voltage: 4.5 to 30 V; OFF voltage: -30 to 2 V; input impedance: 10 kΩ) Open collector (50-KHz max. with ON/OFF pulse width of 9 µs min.)	
<b>Connectable sensors</b>	ON residual voltage: 3 V max. OFF leakage current: 1.5 mA max. Load current: Must have a switching capacity of 20 mA or higher. Must be able to properly switch load currents of 5 mA or less.	
<b>Comparative output response time (transistor output)</b>	Functions F1 to F6: 100 ms max. (time until the comparative output is made when there is a forced sudden change in the input signal from 15% to 95% or 95% to 15%.)	
<b>Linear output response time</b>	Functions F1 to F6: 110 ms max. (time until the final analog output value is reached when there is a forced sudden change in the input signal from 15% to 95% or 95% to 15%.)	
<b>Insulation resistance</b>	20 MΩ min. (at 500 VDC)	
<b>Dielectric strength</b>	2,300 VAC for 1 min between external terminals and case	
<b>Noise immunity</b>	100 to 240 VAC models: ±1,500 V at power supply terminals in normal or common mode (waveform with 1-ns rising edge and pulse width of 1 µs/100 ns) 24 VAC/VDC models: ±1,500 V at power supply terminals in normal or common mode (waveform with 1-ns rising edge and pulse width of 1 µs/100 ns)	
<b>Vibration resistance</b>	Frequency: 10 to 55 Hz; Acceleration: 50 m/s <sup>2</sup> , 10 sweeps of 5 min each in X, Y, and Z directions	
<b>Shock resistance</b>	150 m/s <sup>2</sup> (100 m/s <sup>2</sup> for relay outputs) 3 times each in 3 axes, 6 directions	
<b>Weight</b>	Approx. 300 g (Base Unit only)	
<b>Degree of protection</b>	<b>Front panel</b>	Conforms to NEMA 4X for indoor use (equivalent to IP66)
	<b>Rear case</b>	IP20
	<b>Terminals</b>	IP00 + finger protection (VDE0106/100)
<b>Memory protection</b>	EEPROM (non-volatile memory) Number of rewrites: 100,000	
<b>Applicable standards</b>	UL61010C-1, CSA C22.2 No. 1010.1 (evaluated by UL) EN61010-1 (IEC61010-1): Pollution degree 2/Overvoltage category II EN61326: 1997, A1: 1998, A2: 2001	
<b>EMC</b>	EMI: EN61326+A1 industrial applications Electromagnetic radiation interference CISPR 11 Group 1, Class A: CISPR16-1/-2 Terminal interference voltage CISPR 11 Group 1, Class A: CISPR16-1/-2 EMS: EN61326+A1 industrial applications Electrostatic Discharge Immunity EN61000-4-2: 4 kV (contact), 8 kV (in air) Radiated Electromagnetic Field Immunity EN61000-4-3: 10 V/m 1 kHz sine wave amplitude modulation (80 MHz to 1 GHz, 1.4 to 2 GHz) Electrical Fast Transient/Burst Immunity EN61000-4-4: 2 kV (power line), 1 kV (I/O signal line) Surge Immunity EN61000-4-5: 1 kV with line (power line), 2 kV with ground (power line) Conducted Disturbance Immunity EN61000-4-6: 3 V (0.15 to 80 MHz) Power Frequency Magnetic Immunity EN61000-4-8: 30 A/m (50 Hz) continuous time Voltage Dips and Interruptions Immunity EN61000-4-11: 0.5 cycle, 0°/180°, 100% (rated voltage)	

## K3HB-P

<b>Display range</b>		-19,999 to 99,999																									
<b>Measurement accuracy (at 23±5°C)</b>		±0.08% rdg ±1 digit (for voltage pulse/open collector sensors)																									
<b>Measurement range</b>		Functions F1, F3, and F4: 10 ms to 3,200 s (input pulse interval) Function F2: 20 ms to 3,200 s (input pulse interval) Functions F5 and F6: 0 to 4 gigacounts (number of input pulses)																									
<b>Input signals</b>		<ul style="list-style-type: none"> <li>No-voltage contact (30 Hz max. with ON/OFF pulse width of 15 ms min.)</li> <li>Voltage pulse                             <table border="1" data-bbox="550 465 1385 584"> <thead> <tr> <th>Mode</th> <th>Input frequency range</th> <th>ON/OFF pulse width</th> <th>ON voltage</th> <th>OFF voltage</th> <th>Input impedance</th> </tr> </thead> <tbody> <tr> <td>F1 to F4</td> <td>0 to 50 kHz</td> <td>9 μs min.</td> <td rowspan="2">4.5 to 30 V</td> <td rowspan="2">-30 to 2 V</td> <td rowspan="2">10 kΩ</td> </tr> <tr> <td>F5, F6</td> <td>0 to 30 kHz</td> <td>16 μs min.</td> </tr> </tbody> </table> </li> <li>Open collector                             <table border="1" data-bbox="550 595 957 714"> <thead> <tr> <th>Mode</th> <th>Input frequency range</th> <th>ON/OFF pulse width</th> </tr> </thead> <tbody> <tr> <td>F1 to F4</td> <td>0 to 50 kHz</td> <td>9 μs min.</td> </tr> <tr> <td>F5, F6</td> <td>0 to 30 kHz</td> <td>16 μs min.</td> </tr> </tbody> </table> </li> </ul> <p>Note: The Digital Time Interval Indicator will malfunction if a pulse greater than the input frequency range is input. SYSERR may appear on the display.</p>		Mode	Input frequency range	ON/OFF pulse width	ON voltage	OFF voltage	Input impedance	F1 to F4	0 to 50 kHz	9 μs min.	4.5 to 30 V	-30 to 2 V	10 kΩ	F5, F6	0 to 30 kHz	16 μs min.	Mode	Input frequency range	ON/OFF pulse width	F1 to F4	0 to 50 kHz	9 μs min.	F5, F6	0 to 30 kHz	16 μs min.
Mode	Input frequency range	ON/OFF pulse width	ON voltage	OFF voltage	Input impedance																						
F1 to F4	0 to 50 kHz	9 μs min.	4.5 to 30 V	-30 to 2 V	10 kΩ																						
F5, F6	0 to 30 kHz	16 μs min.																									
Mode	Input frequency range	ON/OFF pulse width																									
F1 to F4	0 to 50 kHz	9 μs min.																									
F5, F6	0 to 30 kHz	16 μs min.																									
<b>Connectable sensors</b>		ON residual voltage: 3 V max. OFF leakage current: 1.5 mA max. Load current: Must have a switching capacity of 20 mA or higher. Must be able to properly switch load currents of 5 mA or less.																									
<b>Comparative output response time (transistor output)</b>		2 ms max. (time until the comparative output is made when there is a forced sudden change in the input signal from 15% to 95% or 95% to 15%)																									
<b>Linear output response time</b>		10 ms max. (time until the final analog output value is reached when there is a forced sudden change in the input signal from 15% to 95% or 95% to 15%)																									
<b>Insulation resistance</b>		20 MΩ min. (at 500 VDC)																									
<b>Dielectric strength</b>		2,300 VAC for 1 min between external terminals and case																									
<b>Noise immunity</b>		100 to 240 VAC models: ±1,500 V at power supply terminals in normal or common mode (waveform with 1-ns rising edge and pulse width of 1 μs/100 ns) 24 VAC/VDC models: ±1,500 V at power supply terminals in normal or common mode (waveform with 1-ns rising edge and pulse width of 1 μs/100 ns)																									
<b>Vibration resistance</b>		Frequency: 10 to 55 Hz; Acceleration: 50 m/s <sup>2</sup> , 10 sweeps of 5 min each in X, Y, and Z directions																									
<b>Shock resistance</b>		150 m/s <sup>2</sup> (100 m/s <sup>2</sup> for relay outputs) 3 times each in 3 axes, 6 directions																									
<b>Weight</b>		Approx. 300 g (Base Unit only)																									
<b>Degree of protection</b>	<b>Front panel</b>	Conforms to NEMA 4X for indoor use (equivalent to IP66)																									
	<b>Rear case</b>	IP20																									
	<b>Terminals</b>	IP00 + finger protection (VDE0106/100)																									
<b>Memory protection</b>		EEPROM (non-volatile memory) Number of rewrites: 100,000																									
<b>Applicable standards</b>		UL61010C-1, CSA C22.2 No. 1010.1 (evaluated by UL) EN61010-1 (IEC61010-1): Pollution degree 2/Overvoltage category II EN61326: 1997, A1: 1998, A2: 2001																									
<b>EMC</b>		EMI: EN61326+A1 industrial applications Electromagnetic radiation interference CISPR 11 Group 1, Class A: CISPR16-1/-2 Terminal interference voltage CISPR 11 Group 1, Class A: CISPR16-1/-2 EMS: EN61326+A1 industrial applications Electrostatic Discharge Immunity EN61000-4-2: 4 kV (contact), 8 kV (in air) Radiated Electromagnetic Field Immunity EN61000-4-3: 10 V/m 1 kHz sine wave amplitude modulation (80 MHz to 1 GHz, 1.4GHz to 2 GHz) Electrical Fast Transient/Burst Immunity EN61000-4-4: 2 kV (power line), 1 kV (I/O signal line) Surge Immunity EN61000-4-5: 1 kV with line (power line), 2 kV with ground (power line) Conducted Disturbance Immunity EN61000-4-6: 3 V (0.15 to 80 MHz) Power Frequency Magnetic Immunity EN61000-4-8: 30 A/m (50 Hz) continuous time Voltage Dips and Interruptions Immunity EN61000-4-11: 0.5 cycle, 0°/180°, 100% (rated voltage)																									

## K3HB-C

<b>Display range</b>	-19,999 to 99,999						
<b>Measurement range</b>	Functions F1, F2: $\pm 2$ gigacounts, Functions F3: 0 to 4 gigacounts						
<b>Input signals</b>	• No-voltage contact (30 Hz max. with ON/OFF pulse width of 15 ms min.)						
	• Voltage pulse	<b>Mode</b>	<b>Input frequency range</b>	<b>ON/OFF pulse width</b>	<b>ON voltage</b>	<b>OFF voltage</b>	<b>Input impedance</b>
		F1	0 to 30 kHz	16 $\mu$ s min.	4.5 to 30 V	-30 to 2 V	10 k $\Omega$
		F2	0 to 25 kHz	20 $\mu$ s min.			
	F3	0 to 50 kHz	9 $\mu$ s min.				
	• Open collector	<b>Mode</b>	<b>Input frequency range</b>	<b>ON/OFF pulse width</b>	Note: The Up/Down Counting Pulse Indicator will malfunction if a pulse greater than the input frequency range is input. SYSERR may appear on the display.		
F1		0 to 30 kHz	16 $\mu$ s min.				
F2		0 to 25 kHz	20 $\mu$ s min.				
F3	0 to 50 kHz	9 $\mu$ s min.					
<b>Connectable sensors</b>	ON residual voltage: 3 V max. OFF leakage current: 1.5 mA max. Load current: Must have a switching capacity of 20 mA or higher. Must be able to properly switch load currents of 5 mA or less.						
<b>Max. No. of display digits</b>	5 (-19999 to 99999)						
<b>Comparative output response time</b>	1 ms max.: Transistor output; 10 ms max.: Relay contact output (time until the comparative output is made when there is a forced sudden change in the input signal from 15% to 95% or 95% to 15%)						
<b>Linear output response time</b>	10 ms max. (time until the final analog output value is reached when there is a forced sudden change in the input signal from 15% to 95% or 95% to 15%)						
<b>Insulation resistance</b>	20 M $\Omega$ min. (at 500 VDC)						
<b>Dielectric strength</b>	2,300 VAC for 1 min between external terminals and case						
<b>Noise immunity</b>	100 to 240 VAC models: $\pm 1,500$ V at power supply terminals in normal or common mode (waveform with 1-ns rising edge and pulse width of 1 $\mu$ s/100 ns) 24 VAC/VDC models: $\pm 1,500$ V at power supply terminals in normal or common mode (waveform with 1-ns rising edge and pulse width of 1 $\mu$ s/100 ns)						
<b>Vibration resistance</b>	Frequency: 10 to 55 Hz; Acceleration: 50 m/s <sup>2</sup> , 10 sweeps of 5 min each in X, Y, and Z directions						
<b>Shock resistance</b>	150 m/s <sup>2</sup> (100 m/s <sup>2</sup> for relay outputs) 3 times each in 3 axes, 6 directions						
<b>Weight</b>	Approx. 300 g (Base Unit only)						
<b>Degree of protection</b>	<b>Front panel</b>	Conforms to NEMA 4X for indoor use (equivalent to IP66)					
	<b>Rear case</b>	IP20					
	<b>Terminals</b>	IP00 + finger protection (VDE0106/100)					
<b>Memory protection</b>	EEPROM (non-volatile memory), Number of rewrites: 100,000						
<b>Applicable standards</b>	UL61010C-1, CSA C22.2 No. 1010.1 (evaluated by UL) EN61010-1 (IEC61010-1): Pollution degree 2/Overvoltage category II EN61326: 1997, A1: 1998, A2: 2001						
<b>EMC</b>	EMI: EN61326+A1 industrial applications Electromagnetic radiation interference CISPR 11 Group 1, Class A: CISPR16-1/-2 Terminal interference voltage CISPR 11 Group 1, Class A: CISPR16-1/-2 EMS: EN61326+A1 industrial applications Electrostatic Discharge Immunity EN61000-4-2: 4 kV (contact), 8 kV (in air) Radiated Electromagnetic Field Immunity EN61000-4-3: 10 V/m 1 kHz sine wave amplitude modulation (80 MHz to 1 GHz, 1.4 to 2 GHz) Electrical Fast Transient/Burst Immunity EN61000-4-4: 2 kV (power line), 1 kV (I/O signal line) Surge Immunity EN61000-4-5: 1 kV with line (power line), 2 kV with ground (power line) Conducted Disturbance Immunity EN61000-4-6: 3 V (0.15 to 80 MHz) Power Frequency Magnetic Immunity EN61000-4-8: 30 A/m (50 Hz) continuous time Voltage Dips and Interruptions Immunity EN61000-4-11: 0.5 cycle, 0°/180°, 100% (rated voltage)						

## ■ Power Supply Derating Curve for Sensor (Reference Value)

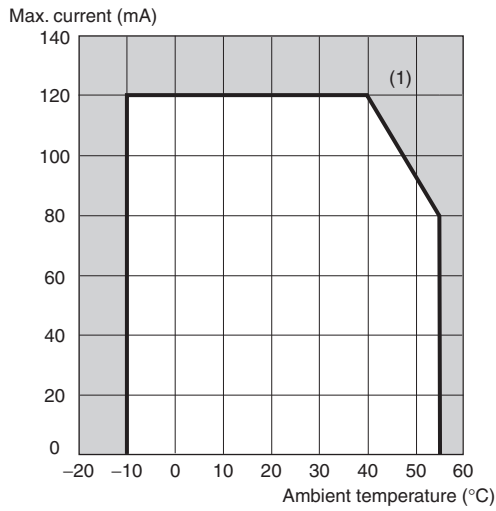

With 12 V

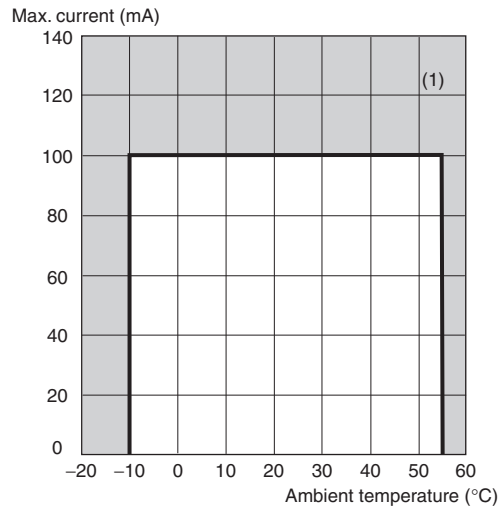

With 10 V

Note 1. The above values are for standard mounting. Be careful because the derating curve depends on the mounting conditions.

2. Do not use the Sensor outside of the derating area (i.e., do not use it in the area labeled (1) in the above graphics). Doing so may deteriorate or damage internal components.

# Model Number Structure

## Base Units with Optional Boards

K3HB--

① ②    ③ ④ ⑤    ⑥

### 1. Models by Type

Code	Input specifications
R	Rotary pulse indicator
P	Time interval indicator
C	Up/Down counting pulse indicator

### 2. Input Range

Code	Auxiliary output and external power supply specifications
NB	NPN voltage pulse input
PB	PNP input

### 3. Analog, Communications, and Other Output Specifications

Code	Auxiliary output and external power supply specifications
None	None
CPA	Relay output (PASS: SPDT) + Sensor power supply (12 VDC, ±10%, 80 mA)
CPB	Relay output (PASS: SPDT) + Sensor power supply (10 VDC, ±5%, 100 mA)
L1A	Linear current output (DC0(4) - 20 mA) + Sensor power supply (12 VDC, ±10%, 80 mA)
L1B	Linear current output (DC0(4) - 20 mA) + Sensor power supply (10 VDC, ±5%, 100 mA)
L2A	Linear voltage output (DC0(1) - 5 V, 0 to 10 V) + Sensor power supply (12 VDC, ±10%, 80 mA)
L2B	Linear voltage output (DC0(1) - 5 V, 0 to 10 V) + Sensor power supply (10 VDC, ±5%, 100 mA)
A	Sensor power supply, 12 VDC, ±10%, 80 mA
B	Sensor power supply, 10 VDC, ±5%, 100 mA
FLK1A	Communications (RS-232C) + Sensor power supply (12 VDC, ±10%, 80 mA)
FLK1B	Communications (RS-232C) + Sensor power supply (10 VDC, ±5%, 100 mA)
FLK3A	Communications (RS-485) + Sensor power supply (12 VDC, ±10%, 80 mA)
FLK3B	Communications (RS-485) + Sensor power supply (10 VDC, ±5%, 100 mA)

### 4. Relay/Transistor Output Specifications

Code	Pulse output specifications
None	None
C1	Relay contact (H/L: SPDT each)
C2	Relay contact (HH/H/LL/L: SPST-NO each)
T1	Transistor (NPN open collector: HH/H/PASS/L/LL)
T2	Transistor (PNP open collector: HH/H/PASS/L/LL)
BCD	BCD output + transistor (NPN open connector HH/H/PASS/L/LL)
DRT	DeviceNet

### 5. Control Input Specifications

Code	Control input specifications
None	None
1	Control input 5 points (M3 terminal blocks) NPN open collector
2	Control input 8 points (10-pin MIL connector) NPN open collector
3	Control input 5 points (M3 terminal blocks) PNP open collector
4	Control input 8 points (10-pin MIL connector) PNP open collector

### 6. Power Supply Specifications

Code	Power supply voltage
100 to 240 VAC	100 to 240 VAC, 50/60 Hz
24 VAC/VDC	24 VAC/VDC, 50/60 Hz

Note:

- CPA and CPB can be combined with relay outputs only.
- Only one of the following can be used by each Digital Indicator: RS-232C/RS-485 communications, BCD communications, or DeviceNet communications.

# Parameter List

Enter the set values before using.

## ● K3HB-R/P

Level	Parameter name	Characters	Setting range	Characters	Initial value	Decimal point	Unit	Set value
---	Version	---	---	---	---	---	---	
	Status	---	---	---	---	---	---	
	Measurement value	---	-19999 to 99999	---	---	---	EU	
	Max. value	---	-19999 to 99999	---	---	---	EU	
	Min. value	---	-19999 to 99999	---	---	---	EU	
Protect	RUN/adjustment protect	rUaPt	0 to 2	0 to 2	0	---	---	
	Setting level protect	SEtPt	0 to 2	0 to 2	1	---	---	
	Setting change protect	ScPt	OFF, ON	OFF, ON	OFF	---	---	
	Max/Min protect	MaPt	0 to 2	0 to 2	0	---	---	
RUN	Measurement value	---	-19999 to 99999 (when time unit is OFF. Lower limit of P is 0) 0 to 99999 (when the time unit is min) 0.00.00 to 9.59.59 (when the time unit is hr: min: s) 00.00.0 to 99.59.9 (when the time unit is min: s: ms)	19999 to 99999 (0 to 99999) 0 to 99999 0.00.00 to 9.59.59 00.00.0 to 99.59.9	---	Conforms to the decimal point position. When the time unit is hr: min: s; *.*.* When the time unit is min: s: ms; **.*	EU	
	Measurement value/comparative set value HH	---	Same as above	Same as above	99999	Conforms to decimal point position.	EU	
	Measurement value/comparative set value H	---	Same as above	Same as above	99999	Conforms to decimal point position.	EU	
	Measurement value/comparative set value L	---	Same as above	Same as above	R: -19999 P: 0	Conforms to decimal point position.	EU	
	Measurement value/comparative set value LL	---	Same as above	Same as above	Same as above	Conforms to decimal point position.	EU	
Adjustment	Bank	bRnP	0 to 7	0 to 7	0	---	---	
	Communication write	CaPt	OFF, ON	OFF, ON	OFF	---	---	
Initial setting	Function	FUnC	F1 to 6	F 1 to 6	F1	---	---	
	Input type A	Ca-tA	No-contact (NO), no-contact (NC), contact (NO), contact (NC)	00, 0 1, 10, 11	No-contact (NO)	---	---	
	Input type B	Ca-tB	No-contact (NO), no-contact (NC), contact (NO), contact (NC)	00, 0 1, 10, 11	No-contact (NO)	---	---	
	Prescale AX	PS. Ax	0.0000 to 9.9999	0.0000 to 9.9999	1.0000	4	---	
	Prescale AY	PS. Ay	-9 to 9	-9 to 9	0	---	---	
	Prescale BX	PS. Bx	0.0000 to 9.9999	0.0000 to 9.9999	1.0000	4	---	
	Prescale BY	PS. By	-9 to 9	-9 to 9	0	---	---	
	Time unit	tUnE	OFF, min, hour: s., min, s: 100 ms	OFF, min, H, min, s, d	OFF	---	---	
	Decimal point position	dP	0 to 4	00000, 0000.0, 000.00, 00.000, 0.0000	0	---	---	
	Comparative output pattern	CaPt-P	Standard outputs, zone outputs, level outputs	na-naRL, Za-nE, L E u EL	Standard outputs	---	---	
Move to the advanced function setting level	RaPa	-19999 to 99999	19999 to 99999	0	---	---		
Input adjustment	Averaging type	RuG-t	Simple average, moving average	SnPL, naPE	Simple average	---	---	
	Averaging times	RuG-n	1/2/4/8/16/32/64/128/256/512/1024	1, 2, 4, 8, 16, 32, 64, 128, 256, 512, 1024	1	---	---	
	Auto-zero time A	Rt.ZA	0.0 to 2999.9	0.0 to 2999.9	2999.9	1	s	
	Auto-zero time B	Rt.ZB	0.0 to 2999.9	0.0 to 2999.9	2999.9	1	s	
Power supply memory	REna	OFF, ON	OFF, ON	OFF	---	---		



Level	Parameter name	Characters	Setting range	Characters	Initial value	Decimal point	Unit	Set value
Display adjustment	Comparative set value display	$\overline{S}u.d\overline{S}P$	OFF, ON	$\overline{\delta}FF, \overline{\delta}n$	OFF	---	---	
	Display refresh period	$d.r\overline{E}F$	OFF, 0.5 s, 1 s, 2 s, 4 s	$\overline{\delta}FF, \overline{0}S, \overline{1}, \overline{2}, \overline{4}$	OFF	---	s	
	Display color selection	$\overline{L}\overline{\delta}L\overline{\delta}r$	Green (red), green, red (green), red	$\overline{G}r\overline{n}-r, \overline{G}r\overline{n}, r\overline{E}d-\overline{G}, r\overline{E}d$	Green (red)	---	---	
	Display value selection	$d.\overline{V}S\overline{P}$	PV, max, min	$\overline{P}u, \overline{n}A\overline{V}, \overline{n}\overline{L}n$	PV	---	---	
	Automatic display return	$r\overline{E}t$	0 to 99	$\overline{0}$ to $\overline{99}$	10	---	s	
	Position meter type	$\overline{P}\overline{\delta}S-t$	OFF, incremental, incremental (reversed), deviation, deviation (reversed)	$\overline{\delta}FF, \overline{i}n\overline{L}, \overline{i}n\overline{L}-r, d\overline{E}u, d\overline{E}u-r$	Incremental	---	---	
	Position meter upper limit	$\overline{P}\overline{\delta}S-H$	Same as measurement value	Same as measurement value	99999	None When the time unit is hr: min: s: *.*.*.* When the time unit is min: s: ms: *.*.*.*	EU	
	Position meter lower limit	$\overline{P}\overline{\delta}S-L$	Same as above	Same as above	R: -19999 P: 0	Same as above	EU	

Level	Parameter name	Characters	Setting range	Characters	Initial value	Decimal point	Unit	Set value
Scaling	Prescaling bank	PS. b <sup>n</sup> P	0 to 7	0 to 7	0	---	---	
	Prescale 0AX	PS0. R <sup>n</sup>	0.0000 to 9.9999	0.0000 to 9.9999	1.0000	1	---	
	Prescale 0AY	PS0. RY	-9 to 9	10 -9 to 10 9	0	---	---	
	Prescale 0BX	PS0. b <sup>n</sup>	0.0000 to 9.9999	0.0000 to 9.9999	1.0000	1	---	
	Prescale 0BY	PS0. bY	-9 to 9	10 -9 to 10 9	0	---	---	
	Decimal point position 0	dP0	0 to 4	00000, 0000.0, 000.00, 00.000, 0.0000	0	---	---	
	Prescale 1AX	PS1. R <sup>n</sup>	0.0000 to 9.9999	0.0000 to 9.9999	1.0000	1	---	
	Prescale 1AY	PS1. RY	-9 to 9	10 -9 to 10 9	0	---	---	
	Prescale 1BX	PS1. b <sup>n</sup>	0.0000 to 9.9999	0.0000 to 9.9999	1.0000	1	---	
	Prescale 1BY	PS1. bY	-9 to 9	10 -9 to 10 9	0	---	---	
	Decimal point position 1	dP1	0 to 4	00000, 0000.0, 000.00, 00.000, 0.0000	0	---	---	
	Prescale 2AX	PS2. R <sup>n</sup>	0.0000 to 9.9999	0.0000 to 9.9999	1.0000	1	---	
	Prescale 2AY	PS2. RY	-9 to 9	10 -9 to 10 9	0	---	---	
	Prescale 2BX	PS2. b <sup>n</sup>	0.0000 to 9.9999	0.0000 to 9.9999	1.0000	1	---	
	Prescale 2BY	PS2. bY	-9 to 9	10 -9 to 10 9	0	---	---	
	Decimal point position 2	dP2	0 to 4	00000, 0000.0, 000.00, 00.000, 0.0000	0	---	---	
	Prescale 3AX	PS3. R <sup>n</sup>	0.0000 to 9.9999	0.0000 to 9.9999	1.0000	1	---	
	Prescale 3AY	PS3. RY	-9 to 9	10 -9 to 10 9	0	---	---	
	Prescale 3BX	PS3. b <sup>n</sup>	0.0000 to 9.9999	0.0000 to 9.9999	1.0000	1	---	
	Prescale 3BY	PS3. bY	-9 to 9	10 -9 to 10 9	0	---	---	
	Decimal point position 3	dP3	0 to 4	00000, 0000.0, 000.00, 00.000, 0.0000	0	---	---	
	Prescale 4AX	PS4. R <sup>n</sup>	0.0000 to 9.9999	0.0000 to 9.9999	1.0000	1	---	
	Prescale 4AY	PS4. RY	-9 to 9	10 -9 to 10 9	0	---	---	
	Prescale 4BX	PS4. b <sup>n</sup>	0.0000 to 9.9999	0.0000 to 9.9999	1.0000	1	---	
	Prescale 4BY	PS4. bY	-9 to 9	10 -9 to 10 9	0	---	---	
	Decimal point position 4	dP4	0 to 4	00000, 0000.0, 000.00, 00.000, 0.0000	0	---	---	
	Prescale 5AX	PS5. R <sup>n</sup>	0.0000 to 9.9999	0.0000 to 9.9999	1.0000	1	---	
	Prescale 5AY	PS5. RY	-9 to 9	10 -9 to 10 9	0	---	---	
	Prescale 5BX	PS5. b <sup>n</sup>	0.0000 to 9.9999	0.0000 to 9.9999	1.0000	1	---	
	Prescale 5BY	PS5. bY	-9 to 9	10 -9 to 10 9	0	---	---	
	Decimal point position 5	dP5	0 to 4	00000, 0000.0, 000.00, 00.000, 0.0000	0	---	---	
	Prescale 6AX	PS6. R <sup>n</sup>	0.0000 to 9.9999	0.0000 to 9.9999	1.0000	1	---	
	Prescale 6AY	PS6. RY	-9 to 9	10 -9 to 10 9	0	---	---	
	Prescale 6BX	PS6. b <sup>n</sup>	0.0000 to 9.9999	0.0000 to 9.9999	1.0000	1	---	
	Prescale 6BY	PS6. bY	-9 to 9	10 -9 to 10 9	0	---	---	
	Decimal point position 6	dP6	0 to 4	00000, 0000.0, 000.00, 00.000, 0.0000	0	---	---	
	Prescale 7AX	PS7. R <sup>n</sup>	0.0000 to 9.9999	0.0000 to 9.9999	1.0000	1	---	
	Prescale 7AY	PS7. RY	-9 to 9	10 -9 to 10 9	0	---	---	
	Prescale 7BX	PS7. b <sup>n</sup>	0.0000 to 9.9999	0.0000 to 9.9999	1.0000	1	---	
	Prescale 7BY	PS7. bY	-9 to 9	10 -9 to 10 9	0	---	---	
	Decimal point position 7	dP7	0 to 4	00000, 0000.0, 000.00, 00.000, 0.0000	0	---	---	
	Bank copy	CPY	OFF, ON	OFF, ON	OFF	---	---	

Level	Parameter name	Characters	Setting range	Characters	Initial value	Decimal point	Unit	Set value
Comparative set value display	Comparative set value bank	50.5000	0 to 7	0 to 7	0	---	---	
	Comparative set value 0HH	50.0000	Same as measurement value	Same as measurement value	99999	Same as measurement value	EU	
	Comparative set value 0H	50.00	Same as above	Same as above	99999	Same as above	EU	
	Comparative set value 0L	50.01	Same as above	Same as above	R: -19999 P: 0	Same as above	EU	
	Comparative set value 0LL	50.01 L	Same as above	Same as above	R: -19999 P: 0	Same as above	EU	
	Comparative set value 1HH	50.1000	Same as above	Same as above	99999	Same as above	EU	
	Comparative set value 1H	50.10	Same as above	Same as above	99999	Same as above	EU	
	Comparative set value 1L	50.11	Same as above	Same as above	R: -19999 P: 0	Same as above	EU	
	Comparative set value 1LL	50.11 L	Same as above	Same as above	R: -19999 P: 0	Same as above	EU	
	Comparative set value 2HH	50.2000	Same as above	Same as above	99999	Same as above	EU	
	Comparative set value 2H	50.20	Same as above	Same as above	99999	Same as above	EU	
	Comparative set value 2L	50.21	Same as above	Same as above	R: -19999 P: 0	Same as above	EU	
	Comparative set value 2LL	50.21 L	Same as above	Same as above	R: -19999 P: 0	Same as above	EU	
	Comparative set value 3HH	50.3000	Same as above	Same as above	99999	Same as above	EU	
	Comparative set value 3H	50.30	Same as above	Same as above	99999	Same as above	EU	
	Comparative set value 3L	50.31	Same as above	Same as above	R: -19999 P: 0	Same as above	EU	
	Comparative set value 3LL	50.31 L	Same as above	Same as above	R: -19999 P: 0	Same as above	EU	
	Comparative set value 4HH	50.4000	Same as above	Same as above	99999	Same as above	EU	
	Comparative set value 4H	50.40	Same as above	Same as above	99999	Same as above	EU	
	Comparative set value 4L	50.41	Same as above	Same as above	R: -19999 P: 0	Same as above	EU	
	Comparative set value 4LL	50.41 L	Same as above	Same as above	R: -19999 P: 0	Same as above	EU	
	Comparative set value 5HH	50.5000	Same as above	Same as above	99999	Same as above	EU	
	Comparative set value 5H	50.50	Same as above	Same as above	99999	Same as above	EU	
	Comparative set value 5L	50.51	Same as above	Same as above	R: -19999 P: 0	Same as above	EU	
	Comparative set value 5LL	50.51 L	Same as above	Same as above	R: -19999 P: 0	Same as above	EU	
	Comparative set value 6HH	50.6000	Same as above	Same as above	99999	Same as above	EU	
	Comparative set value 6H	50.60	Same as above	Same as above	99999	Same as above	EU	
	Comparative set value 6L	50.61	Same as above	Same as above	R: -19999 P: 0	Same as above	EU	
	Comparative set value 6LL	50.61 L	Same as above	Same as above	R: -19999 P: 0	Same as above	EU	
	Comparative set value 7HH	50.7000	Same as above	Same as above	99999	Same as above	EU	
Comparative set value 7H	50.70	Same as above	Same as above	99999	Same as above	EU		
Comparative set value 7L	50.71	Same as above	Same as above	R: -19999 P: 0	Same as above	EU		
Comparative set value 7LL	50.71 L	Same as above	Same as above	R: -19999 P: 0	Same as above	EU		
Bank copy	50.0000	off, on	OFF, ON	OFF	---	---	---	

Level	Parameter name	Characters	Setting range	Characters	Initial value	Decimal point	Unit	Set value
Linear output	Linear current type	LSL.L	0-20 mA, 4-20 mA	0-20, 4-20	4-20 mA	---	---	
	Linear voltage type	LSL.V	0-5 V, 1-5 V, 0-10 V	0-5, 1-5, 0-10	1-5 V	---	---	
	Linear output upper limit	LSL.H	Same as measurement value	Same as measurement value	99999	None When the time unit is hr: min: s; *.*.* When the time unit is min: s: ms; *.*.*	EU	
	Linear output lower limit	LSL.L	Same as above	Same as above	R: -19999 P: 0	Same as above	EU	
Communications settings	Communications unit number	U-n	0 to 99	0 to 99	1	---	---	
	Baud rate	bPS	9.6, 19.2, 38.4	9.6, 19.2, 38.4	9.6	---	kbps	
	Communications data length	LEn	7, 8	7, 8	7	---	bit	
	Communications stop bits	Sb.L	1, 2	1, 2	2	---	bit	
	Communications parity	P.r.L	None, even, odd	nOnE, EvEn, oDd	Even	---	---	
	Send wait time	Sd.L	0 to 99	0 to 99	20	---	ms	
Output test	Test input	LES	OFF, -19999 to 99999 (when time limit is OFF. Lower limit of P is 0) OFF, 0 to 99999 (when the time unit is min) OFF, 0.00.00 to 9.59.59 (when the time unit is hr: min: s) OFF 00.00.0 to 99.59.9 (when the time unit is min: s: ms)	OFF, -19999 to 99999 (0 to 99999) OFF, 0 to 99999 OFF, 0.00.00 to 9.59.59 OFF, 00.00.0 to 99.59.9	OFF	None When the time unit is hr: min: s; *.*.* When the time unit is min: s: ms; *.*.*	EU	
Advanced function settings	Set value initialization	Ln.L	OFF, ON	OFF, On	OFF	---	---	
	PASS output change	PRSS	LL, L, PASS, H, HH, and ERR	LL, L, PRSS, H, HH, Err	PASS	---	---	
	Hysteresis	HY5	0 to 9999 (when time limit is OFF. Lower limit of P is 0) 0.00.00 to 0.59.59 (when the time unit is hr: min: s) 00.00.0 to 09.59.9 (when the time unit is min: s: ms)	0 to 9999 0.00.00 to 0.59.59 00.00.0 to 09.59.9	1	None When the time unit is hr: min: s; *.*.* When the time unit is min: s: ms; *.*.*	EU	
	Output OFF delay	OFF-d	0 to 1999	0 to 1999	0	---	R: 100 ms P: ms	
	Shot output	SH.L	0 to 1999	0 to 1999	0	---	R: 100 ms P: ms	
	Output logic	OUT-n	Close in alarm, open in alarm	n-o, n-l	Close in alarm	---	---	
	Output refresh stop	o-S.P	OFF, OUT, ALL	OFF, OUT, ALL	OFF	---	---	
	Bank selection	bn.P.L	OFF, KEY, EV	OFF, KEY, Ev	OFF*	---	---	
	Startup compensation timer	S-t.n	0.0 to 99.9	0.0 to 99.9	0.0	1	s	
Others	Standby sequence	St.d.L	OFF, ON	OFF, On	OFF	---	---	
	Linear output calibration value H	---	---	---	---	---	---	
	Linear output calibration value L	---	---	---	---	---	---	

\*1 Variable C0 is used for reading communications data.

\*2 Set the “bank” parameter to “EV” when an event input (connector) is mounted as a standard feature or has been added.

● K3HB-C

Level	Parameter name	Characters	Setting range	Characters	Initial value	Decimal point	Unit	Set value
---	Version	---	---	---	---	---	---	
	Status	---	---	---	---	---	---	
	Measurement value	---	-19999 to 99999	---	---	---	EU	
	Max. value	---	-19999 to 99999	---	---	---	EU	
	Min. value	---	-19999 to 99999	---	---	---	EU	
Protect	RUN/adjustment protect	ᠷᠠᠨᠠᠵᠢᠮᠤᠮᠤᠯᠠᠰᠤ	0 to 2	᠐ to 2	0	---	---	
	Setting level protect	ᠰᠡᠭᠡᠯᠡᠯᠠᠰᠤ	0 to 2	᠐ to 2	1	---	---	
	Setting change protect	ᠶᠡᠯᠡᠰᠤ	OFF, ON	᠔᠖᠖, ᠔᠗	OFF	---	---	
	Max/Min protect	ᠨᠠᠮᠤᠮᠤᠯᠠᠰᠤ	0 to 2	᠐ to 2	0	---	---	
RUN	Measurement value	---	-19999 to 99999	ᠠ᠑᠑᠑᠑ to ᠑᠑᠑᠑᠑	---	Conforms to decimal point position.	EU	
	Measurement value/comparative set value 5	---	-19999 to 99999	ᠠ᠑᠑᠑᠑ to ᠑᠑᠑᠑᠑	99999	Conforms to decimal point position.	EU	
	Measurement value/comparative set value 4	---	-19999 to 99999	ᠠ᠑᠑᠑᠑ to ᠑᠑᠑᠑᠑	99999	Conforms to decimal point position.	EU	
	Measurement value/comparative set value 3	---	-19999 to 99999	ᠠ᠑᠑᠑᠑ to ᠑᠑᠑᠑᠑	99999	Conforms to decimal point position.	EU	
	Measurement value/comparative set value 2	---	-19999 to 99999	ᠠ᠑᠑᠑᠑ to ᠑᠑᠑᠑᠑	99999	Conforms to decimal point position.	EU	
	Measurement value/comparative set value 1	---	-19999 to 99999	ᠠ᠑᠑᠑᠑ to ᠑᠑᠑᠑᠑	99999	Conforms to decimal point position.	EU	
Adjustment	Bank	ᠪᠠᠶᠠᠨᠠ	0 to 7	᠐ to 7	0	---	---	
	Communication write	ᠴᠠᠮᠠᠮᠤᠨᠠᠵᠢᠮᠤᠯᠠᠰᠤ	OFF, ON	᠔᠖᠖, ᠔᠗	OFF	---	---	
Initial setting	Function	ᠮᠤᠮᠤᠨᠠᠵᠢᠮᠤᠯᠠᠰᠤ	Individual inputs, phase differential inputs, pulse counting input	F 1, F2, F3	Pulse counting input	---	---	
	Input type A	ᠴᠠᠨᠠᠨᠠᠵᠢᠮᠤᠯᠠᠰᠤ	No-contact (NO), no-contact (NC), contact (NO), contact (NC)	᠐᠐, ᠐ 1, 1᠐, 1 1	No-contact (NO)	---	---	
	Input type B	ᠴᠠᠨᠠᠨᠠᠵᠢᠮᠤᠯᠠᠰᠤ	No-contact (NO), no-contact (NC), contact (NO), contact (NC)	᠐᠐, ᠐ 1, 1᠐, 1 1	No-contact (NO)	---	---	
	Prescale X	ᠮᠤᠮᠤᠨᠠᠵᠢᠮᠤᠯᠠᠰᠤ	0.0000 to 9.9999	᠐.0000 to 9.9999	1.0000	4	---	
	Prescale Y	ᠮᠤᠮᠤᠨᠠᠵᠢᠮᠤᠯᠠᠰᠤ	-9 to 9	-9 to 9	0	---	---	
	Decimal point position	ᠳᠡᠮᠠᠮᠤᠨᠠᠵᠢᠮᠤᠯᠠᠰᠤ	0 to 4	᠐᠐᠐᠐᠐, ᠐᠐᠐᠐.᠐, ᠐᠐᠐.᠐᠐, ᠐᠐.᠐᠐᠐, ᠐.᠐᠐᠐᠐	0	---	---	
	Comparative output pattern	ᠳᠡᠮᠠᠮᠤᠨᠠᠵᠢᠮᠤᠯᠠᠰᠤ	Zone outputs, level outputs	ᠰᠠᠨᠠᠵᠢᠮᠤᠯᠠᠰᠤ, ᠰᠠᠨᠠᠵᠢᠮᠤᠯᠠᠰᠤ	Level outputs	---	---	
Move to the advanced function setting level	ᠮᠤᠮᠤᠨᠠᠵᠢᠮᠤᠯᠠᠰᠤ	-19999 to 99999	ᠠ᠑᠑᠑᠑ to ᠑᠑᠑᠑᠑	0	---	---		
Input adjustment	Compensation value	ᠴᠠᠮᠠᠮᠤᠨᠠᠵᠢᠮᠤᠯᠠᠰᠤ	-19999 to 99999	ᠠ᠑᠑᠑᠑ to ᠑᠑᠑᠑᠑	0	---	EU	
	Compensation conditions	ᠴᠠᠮᠠᠮᠤᠨᠠᠵᠢᠮᠤᠯᠠᠰᠤ	None, When input is addition	ᠨᠠᠨᠠᠵᠢᠮᠤᠯᠠᠰᠤ, ᠮᠤᠮᠤᠨᠠᠵᠢᠮᠤᠯᠠᠰᠤ	None	---	---	
	Power supply memory	ᠮᠤᠮᠤᠨᠠᠵᠢᠮᠤᠯᠠᠰᠤ	OFF, ON	᠔᠖᠖, ᠔᠗	OFF	---	---	
Display adjustment	Comparative set value display	ᠰᠠᠨᠠᠵᠢᠮᠤᠯᠠᠰᠤ	OFF, ON	᠔᠖᠖, ᠔᠗	OFF	---	---	
	Display refresh period	ᠳᠡᠮᠠᠮᠤᠨᠠᠵᠢᠮᠤᠯᠠᠰᠤ	OFF, 0.5 s, 1 s, 2 s, 4 s	᠔᠖᠖, ᠐.5, 1, 2, 4	OFF	---	s	
	Display color selection	ᠴᠠᠨᠠᠨᠠᠵᠢᠮᠤᠯᠠᠰᠤ	Green (red), green, red (green), red	ᠴᠠᠨᠠᠨᠠᠵᠢᠮᠤᠯᠠᠰᠤ, ᠴᠠᠨᠠᠨᠠᠵᠢᠮᠤᠯᠠᠰᠤ, ᠴᠠᠨᠠᠨᠠᠵᠢᠮᠤᠯᠠᠰᠤ, ᠴᠠᠨᠠᠨᠠᠵᠢᠮᠤᠯᠠᠰᠤ	Green (red)	---	---	
	Display value selection	ᠳᠡᠮᠠᠮᠤᠨᠠᠵᠢᠮᠤᠯᠠᠰᠤ	PV, max, min	ᠮᠤᠮᠤᠨᠠᠵᠢᠮᠤᠯᠠᠰᠤ, ᠮᠤᠮᠤᠨᠠᠵᠢᠮᠤᠯᠠᠰᠤ	PV	---	---	
	Automatic display return	ᠳᠡᠮᠠᠮᠤᠨᠠᠵᠢᠮᠤᠯᠠᠰᠤ	0 to 99	᠐ to 99	10	---	s	
	Position meter type	ᠮᠤᠮᠤᠨᠠᠵᠢᠮᠤᠯᠠᠰᠤ	OFF, incremental, incremental (reversed), deviation, deviation (reversed)	᠔᠖᠖, ᠴᠠᠨᠠᠨᠠᠵᠢᠮᠤᠯᠠᠰᠤ, ᠴᠠᠨᠠᠨᠠᠵᠢᠮᠤᠯᠠᠰᠤ, ᠳᠡᠮᠠᠮᠤᠨᠠᠵᠢᠮᠤᠯᠠᠰᠤ, ᠳᠡᠮᠠᠮᠤᠨᠠᠵᠢᠮᠤᠯᠠᠰᠤ	Incremental	---	---	
	Position meter upper limit	ᠮᠤᠮᠤᠨᠠᠵᠢᠮᠤᠯᠠᠰᠤ	-19999 to 99999	ᠠ᠑᠑᠑᠑ to ᠑᠑᠑᠑᠑	99999	---	EU	
Position meter lower limit	ᠮᠤᠮᠤᠨᠠᠵᠢᠮᠤᠯᠠᠰᠤ	-19999 to 99999	ᠠ᠑᠑᠑᠑ to ᠑᠑᠑᠑᠑	-19999	---	EU		

Level	Parameter name	Characters	Setting range	Characters	Initial value	Decimal point	Unit	Set value
Scaling	Prescaling bank	PS.bnP	0 to 7	0 to 7	0	---	---	
	Prescale 0X	PS0.RC	0.0000 to 9.9999	0.0000 to 9.9999	1.0000	1	---	
	Prescale 0Y	PS0.RY	-9 to 9	0 -9 to 0 9	0	---	---	
	Decimal point position 0	dP0	0 to 4	00000, 0000.0, 000.00, 00.000, 0.0000	0	---	---	
	Prescale 1X	PS1.RC	0.0000 to 9.9999	0.0000 to 9.9999	1.0000	1	---	
	Prescale 1Y	PS1.RY	-9 to 9	0 -9 to 0 9	0	---	---	
	Decimal point position 1	dP1	0 to 4	00000, 0000.0, 000.00, 00.000, 0.0000	0	---	---	
	Prescale 2X	PS2.RC	0.0000 to 9.9999	0.0000 to 9.9999	1.0000	1	---	
	Prescale 2Y	PS2.RY	-9 to 9	0 -9 to 0 9	0	---	---	
	Decimal point position 2	dP2	0 to 4	00000, 0000.0, 000.00, 00.000, 0.0000	0	---	---	
	Prescale 3X	PS3.RC	0.0000 to 9.9999	0.0000 to 9.9999	1.0000	1	---	
	Prescale 3Y	PS3.RY	-9 to 9	0 -9 to 0 9	0	---	---	
	Decimal point position 3	dP3	0 to 4	00000, 0000.0, 000.00, 00.000, 0.0000	0	---	---	
	Prescale 4X	PS4.RC	0.0000 to 9.9999	0.0000 to 9.9999	1.0000	1	---	
	Prescale 4Y	PS4.RY	-9 to 9	0 -9 to 0 9	0	---	---	
	Decimal point position 4	dP4	0 to 4	00000, 0000.0, 000.00, 00.000, 0.0000	0	---	---	
	Prescale 5X	PS5.RC	0.0000 to 9.9999	0.0000 to 9.9999	1.0000	1	---	
	Prescale 5Y	PS5.RY	-9 to 9	0 -9 to 0 9	0	---	---	
	Decimal point position 5	dP5	0 to 4	00000, 0000.0, 000.00, 00.000, 0.0000	0	---	---	
	Prescale 6X	PS6.RC	0.0000 to 9.9999	0.0000 to 9.9999	1.0000	1	---	
Prescale 6Y	PS6.RY	-9 to 9	0 -9 to 0 9	0	---	---		
Decimal point position 6	dP6	0 to 4	00000, 0000.0, 000.00, 00.000, 0.0000	0	---	---		
Prescale 7X	PS7.RC	0.0000 to 9.9999	0.0000 to 9.9999	1.0000	1	---		
Prescale 7Y	PS7.RY	-9 to 9	0 -9 to 0 9	0	---	---		
Decimal point position 7	dP7	0 to 4	00000, 0000.0, 000.00, 00.000, 0.0000	0	---	---		
	Bank copy	CPY	OFF, ON	OFF, ON	OFF	---	---	
Comparative set value display	Comparative set value bank	Su.bnP	0 to 7	0 to 7	0	---	---	
	Comparative set value 05	Su.05	-19999 to 99999	-99999 to 99999	99999	Conforms to decimal point position.	EU	
	Comparative set value 04	Su.04	-19999 to 99999	-99999 to 99999	99999	Conforms to decimal point position.	EU	
	Comparative set value 03	Su.03	-19999 to 99999	-99999 to 99999	99999	Conforms to decimal point position.	EU	
	Comparative set value 02	Su.02	-19999 to 99999	-99999 to 99999	99999	Conforms to decimal point position.	EU	
	Comparative set value 01	Su.01	-19999 to 99999	-99999 to 99999	99999	Conforms to decimal point position.	EU	
	Comparative set value 15	Su.15	-19999 to 99999	-99999 to 99999	99999	Conforms to decimal point position.	EU	
	Comparative set value 14	Su.14	-19999 to 99999	-99999 to 99999	99999	Conforms to decimal point position.	EU	
	Comparative set value 13	Su.13	-19999 to 99999	-99999 to 99999	99999	Conforms to decimal point position.	EU	
	Comparative set value 12	Su.12	-19999 to 99999	-99999 to 99999	99999	Conforms to decimal point position.	EU	
	Comparative set value 11	Su.11	-19999 to 99999	-99999 to 99999	99999	Conforms to decimal point position.	EU	
	Comparative set value 25	Su.25	-19999 to 99999	-99999 to 99999	99999	Conforms to decimal point position.	EU	
	Comparative set value 24	Su.24	-19999 to 99999	-99999 to 99999	99999	Conforms to decimal point position.	EU	
	Comparative set value 23	Su.23	-19999 to 99999	-99999 to 99999	99999	Conforms to decimal point position.	EU	

Level	Parameter name	Characters	Setting range	Characters	Initial value	Decimal point	Unit	Set value
Comparative set value display	Comparative set value 22	50202	-19999 to 99999	49999 to 99999	99999	Conforms to decimal point position.	EU	
	Comparative set value 21	50201	-19999 to 99999	49999 to 99999	99999	Conforms to decimal point position.	EU	
	Comparative set value 35	50305	-19999 to 99999	49999 to 99999	99999	Conforms to decimal point position.	EU	
	Comparative set value 34	50304	-19999 to 99999	49999 to 99999	99999	Conforms to decimal point position.	EU	
	Comparative set value 33	50303	-19999 to 99999	49999 to 99999	99999	Conforms to decimal point position.	EU	
	Comparative set value 32	50302	-19999 to 99999	49999 to 99999	99999	Conforms to decimal point position.	EU	
	Comparative set value 31	50301	-19999 to 99999	49999 to 99999	99999	Conforms to decimal point position.	EU	
	Comparative set value 45	50405	-19999 to 99999	49999 to 99999	99999	Conforms to decimal point position.	EU	
	Comparative set value 44	50404	-19999 to 99999	49999 to 99999	99999	Conforms to decimal point position.	EU	
	Comparative set value 43	50403	-19999 to 99999	49999 to 99999	99999	Conforms to decimal point position.	EU	
	Comparative set value 42	50402	-19999 to 99999	49999 to 99999	99999	Conforms to decimal point position.	EU	
	Comparative set value 41	50401	-19999 to 99999	49999 to 99999	99999	Conforms to decimal point position.	EU	
	Comparative set value 55	50505	-19999 to 99999	49999 to 99999	99999	Conforms to decimal point position.	EU	
	Comparative set value 54	50504	-19999 to 99999	49999 to 99999	99999	Conforms to decimal point position.	EU	
	Comparative set value 53	50503	-19999 to 99999	49999 to 99999	99999	Conforms to decimal point position.	EU	
	Comparative set value 52	50502	-19999 to 99999	49999 to 99999	99999	Conforms to decimal point position.	EU	
	Comparative set value 51	50501	-19999 to 99999	49999 to 99999	99999	Conforms to decimal point position.	EU	
	Comparative set value 65	50605	-19999 to 99999	49999 to 99999	99999	Conforms to decimal point position.	EU	
	Comparative set value 64	50604	-19999 to 99999	49999 to 99999	99999	Conforms to decimal point position.	EU	
	Comparative set value 63	50603	-19999 to 99999	49999 to 99999	99999	Conforms to decimal point position.	EU	
Comparative set value 62	50602	-19999 to 99999	49999 to 99999	99999	Conforms to decimal point position.	EU		
Comparative set value 61	50601	-19999 to 99999	49999 to 99999	99999	Conforms to decimal point position.	EU		
Comparative set value 75	50705	-19999 to 99999	49999 to 99999	99999	Conforms to decimal point position.	EU		
Comparative set value 74	50704	-19999 to 99999	49999 to 99999	99999	Conforms to decimal point position.	EU		
Comparative set value 73	50703	-19999 to 99999	49999 to 99999	99999	Conforms to decimal point position.	EU		
Comparative set value 72	50702	-19999 to 99999	49999 to 99999	99999	Conforms to decimal point position.	EU		
Comparative set value 71	50701	-19999 to 99999	49999 to 99999	99999	Conforms to decimal point position.	EU		
Bank copy	50804	off, on	0FF, 0n	OFF	---	---	---	
Linear output	Linear current type	55E0E	0-20 mA, 4-20 mA	0-20, 4-20	4-20 mA	---	---	
	Linear voltage type	55E0V	0-5 V, 1-5 V, 0-10 V	0-5, 1-5, 0-10	1-5 V	---	---	
	Linear output upper limit	55E0H	-19999 to 99999	49999 to 99999	99999	---	EU	
	Linear output lower limit	55E0L	-19999 to 99999	49999 to 99999	-19999	---	EU	
Communications settings	Communications unit number	57000	0 to 99	0 to 99	1	---	---	
	Baud rate	57005	9.6, 19.2, 38.4	9.6, 19.2, 38.4	9.6	---	kbps	
	Communications data length	57007	7, 8	7, 8	7	---	bit	
	Communications stop bits	57002	1, 2	1, 2	2	---	bit	
	Communications parity	57004	None, even, odd	none, E, odd	Even	---	---	
Send wait time	57006	0 to 99	0 to 99	20	---	ms		
Output test	Test input	58E0E	OFF, -19999 to 99999	0FF, 49999 to 99999	OFF	---	EU	

Level	Parameter name	Characters	Setting range	Characters	Initial value	Decimal point	Unit	Set value
Advanced function settings	Set value initialization	ニニニ	OFF, ON	OFF, ON	OFF	---	---	
	Output OFF delay	OFF-d	0 to 1999	0 to 1999	0	---	ms	
	Shot output	SHOUT	0 to 1999	0 to 1999	0	---	ms	
	Output logic	OUT-LOGIC	Close in alarm, open in alarm	ON-OFF, ON-ON	Close in alarm	---	---	
	Bank selection	bank-SEL	OFF, KEY, EV	OFF, KEY, EV	OFF*	---	---	
Others	Linear output calibration value H	---	---	---	---	---	---	
	Linear output calibration value L	---	---	---	---	---	---	

\*3 Variable C0 is used for reading communications data.

\*4 Set the “bank” parameter to “EV” when an event input (connector) is mounted as a standard feature or has been added.



# Parameter Display Conditions

## ● K3HB-R/P

Level	Parameter name	Characters	R	P	<1> <2> <3> <4>	<C1>	<C2>	<T1> <T2>	<BCD>	<CPA> <CPB>	<L1A> <L1B>	<L2A> <L2B>	<FLK1A> <FLK1B> <FLK2A> <FLK2L	<DRT>	Setting Conditions
Protect	RUN/adjustment protect	rūn.Pt													
	Setting level protect	SEt.Pt													
	Setting change protect	Ųt.Pt													
	Max./Min. protect	nñ.Pt													
RUN	Measurement value	---													PASS output change = PASS or ERR
	Measurement value/comparative set value HH	---					•	•	•	•					When the Output Unit is only <CPA/B>, change in PASS output = HH.
	Measurement value/comparative set value H	---				•	•	•	•	•					When the Output Unit is only <CPA/B>, change in PASS output = H.
	Measurement value/comparative set value L	---				•	•	•	•	•					When the Output Unit is only <CPA/B>, change in PASS output = L.
	Measurement value/comparative set value LL	---					•	•	•	•					When the Output Unit is only <CPA/B>, change in PASS output = LL.
Adjustment	Bank	bRnK													Bank selection = KEY
	Communication write	ĹñŲt											•		
Initialization	Function	FūnĹ													
	Input type A	ūn-tR													
	Input type B	ūn-tb													When function requires two inputs
	Prescale AX	P5. Rū													Bank selection = OFF
	Prescale AY	P5. RŲ													Bank selection = OFF
	Prescale BX	P5. bū		×											Bank selection = OFF, and function requires two inputs
	Prescale BY	P5. bŲ		×											Bank selection = OFF, and function requires two inputs
	Time unit	tūñĹ													R: When using F6 (passage time) P: When using F2 (cycle), F3 (time difference), or F4 (time band)
	Decimal point position	dP													Bank selection = OFF.
	Comparative output pattern	ōūĹ-P					•	•	•	•	•				
Move to the advanced-function setting level.	Rñōu													Setting level protect = 0	

Level	Parameter name	Characters	R	P	<1> <2> <3> <4>	<C1>	<C2>	<T1> <T2>	<BCD>	<CPA> <CPB>	<L1A> <L1B>	<L2A> <L2B>	<FLK1A> <FLK1B> <FLK2A> <FLK2L	<DRT>	Setting Conditions
Input adjustment	Average type	R <sub>u</sub> G-t		x											
	Averaging times	R <sub>u</sub> G-n		x											
	Auto-zero time A	R <sub>e</sub> .Z <sub>A</sub>		x											
	Auto-zero time B	R <sub>e</sub> .Z <sub>B</sub>		x											When function requires two inputs
	Power interruption memory	nE <sub>n</sub> o													
Display adjustment	Comparative set value display	S <sub>u</sub> d.SP				•	•	•	•	•					When the Output Unit is <CPA>, change in PASS output ≠ PASS or ERR.
	Display refresh period	d.rEF													
	Display color selection	L <sub>o</sub> L.o <sub>r</sub>													
	Display value selection	d <sub>i</sub> SP													
	Automatic display return	rEt													
	Position meter type	P <sub>o</sub> S-t													
	Position meter upper limit	P <sub>o</sub> S-H													Position meter type ≠ OFF
	Position meter lower limit	P <sub>o</sub> S-L													Position meter type ≠ OFF
Scaling	Prescaling bank	P <sub>S</sub> .b <sub>n</sub> M													Bank selection ≠ OFF
	Prescale * AX (*: 0-7)	P <sub>S</sub> .R <sub>u</sub>													Bank selection ≠ OFF; * is the value between 0 and 7 set for the comparative set value bank.
	Prescale * AY (*: 0-7)	P <sub>S</sub> .R <sub>y</sub>													Bank selection ≠ OFF; * is the value between 0 and 7 set for the comparative set value bank.
	Prescale * BX (*: 0-7)	P <sub>S</sub> .b <sub>x</sub>		x											Bank selection ≠ OFF; * is the value between 0 and 7 set for the comparative set value bank.
	Prescale * BY (*: 0-7)	P <sub>S</sub> .b <sub>y</sub>		x											Bank selection ≠ OFF; * is the value between 0 and 7 set for the comparative set value bank.
	Decimal point position * (*: 0-7)	dP <sub>o</sub>													Bank selection ≠ OFF; * is the value between 0 and 7 set for the comparative set value bank.
	Bank copy	L <sub>o</sub> P <sub>y</sub>													Bank selection ≠ OFF

Level	Parameter name	Characters	R	P	<1> <2> <3> <4>	<C1>	<C2>	<T1> <T2>	<BCD>	<CPA> <CPB>	<L1A> <L1B>	<L2A> <L2B>	<FLK1A> <FLK1B> <FLK2A> <FLK2L	<DRT>	Setting Conditions
Comparative set value	Comparative set value bank	5u.bn*				•	•	•	•	•					Bank selection ≠ OFF When the Output Unit is <CPA>, change in PASS output ≠ PASS or ERR.
	Comparative set value * HH (*:0 to 7)	5u.HH					•	•	•	•					Bank selection ≠ OFF; * is the value between 0 and 7 set for the comparative set value bank. When the Output Unit is <CPA>, change in PASS output = HH.
	Comparative set value * H (*:0 to 7)	5u.H				•	•	•	•	•					Bank selection ≠ OFF; * is the value between 0 and 7 set for the comparative set value bank. When the Output Unit is <CPA>, change in PASS output = H.
	Comparative set value * L (*:0 to 7)	5u.L				•	•	•	•	•					Bank selection ≠ OFF; * is the value between 0 and 7 set for the comparative set value bank. When the Output Unit is <CPA>, change in PASS output = L.
	Comparative set value * LL (*:0 to 7)	5u.LL					•	•	•	•					Bank selection ≠ OFF; * is the value between 0 and 7 set for the comparative set value bank. When the Output Unit is <CPA>, change in PASS output = LL.
	Bank copy	5OPY				•	•	•	•	•					Bank selection ≠ OFF When the Output Unit is <CPA>, change in PASS output ≠ PASS or ERR.
Linear output	Linear current type	LSEt. I									•				
	Linear voltage type	LSEt. u										•			
	Linear output upper limit	LSEt. H									•	•			
	Linear output lower limit	LSEt. L									•	•			
Communications settings	Communications unit No.	U-nō											•	•	
	Baud rate	bP5											•		
	Communications data length	LEn											•		
	Communications stop bits	5bc.t											•		
	Communications parity	Pp.tY											•		
	Communications wait time	5dY.t											•		
Output test	Test input	tES.t													

Level	Parameter name	Characters	R	P	<1> <2> <3> <4>	<C1>	<C2>	<T1> <T2>	<BCD>	<CPA> <CPB>	<L1A> <L1B>	<L2A> <L2B>	<FLK1A> <FLK1B> <FLK2A> <FLK2L	<DRT>	Setting Conditions
Advanced-function	Set value initialization	ĩñĩĩ													
	PASS output change	PR55						•	•	•					
	Hysteresis	HY5		×		•	•	•	•	•					When the Output Unit is <CPA>, change in PASS output ≠ PASS or ERR.
	Output OFF delay	õFF-d				•	•	•	•	•					
	Shot output	SHõĩ				•	•	•	•	•					
	Output logic	õũĩ-ñ				•	•	•	•	•					
	Output refresh stop	õ-5ĩP				•	•	•	•	•					
	Bank selection	bnM-ĩ													
	Startup compensation timer	5-ĩñr		×	•										
Standby sequence	5ĩdbũ				•	•	•	•	•					When the Output Unit is <CPA/B>, change in PASS output ≠ PASS or ERR.	

● K3HB-C

Level	Parameter name	Characters	<1> <2> <3> <4>	<C1>	<C2>	<T1> <T2>	<BCD>	<CPA> <CPB>	<L1A> <L1B>	<L2A> <L2B>	<FLK1A> <FLK1B> <FLK2A> <FLK2L	<DRT>	Setting Conditions
Protect	RUN/adjustment protect	rūn.Pt											
	Setting level protect	SEt.Pt											
	Setting change protect	St.Pt											
	Max./Min. protect	nñ.Pt											
RUN	Measurement value	---											
	Measurement value/comparative set value 5	---			●	●	●						
	Measurement value/comparative set value 4	---		●	●	●	●						
	Measurement value/comparative set value 3	---				●	●	●					
	Measurement value/comparative set value 2	---		●	●	●	●						
	Measurement value/comparative set value 1	---			●	●	●						
Adjustment	Bank	bRnM											Bank selection = KEY
	Communication write	EnSt									●		
Initialization	Function	FUnE											
	Input type A	En-tR											
	Input type B	En-tb											When function requires two inputs
	Prescale X	P5.Rū											Bank selection = OFF
	Prescale Y	P5.RY											Bank selection = OFF
	Decimal point position	dP											Bank selection = OFF
	Comparative output pattern	ōSt-P		●	●	●	●	●					
Move to the advanced-function setting level.	Rñōu												Setting level protect = 0
Input adjustment	Compensation value	EnōPn	●				●						
	Compensation conditions	Enñ-P	●				●						
	Power interruption memory	nEnō											
Display adjustment	Comparative set value display	Sud.SP		●	●	●	●	●					
	Display refresh period	d.rEF											
	Display color selection	Enōōr											
	Display value selection	d.SP											
	Automatic display return	rEt											
	Position meter type	Pō5-t											
	Position meter upper limit	Pō5-H											Position meter type ≠ OFF
	Position meter lower limit	Pō5-L											Position meter type ≠ OFF

Level	Parameter name	Characters	<1> <2> <3> <4>	<C1>	<C2>	<T1> <T2>	<BCD>	<CPA> <CPB>	<L1A> <L1B>	<L2A> <L2B>	<FLK1A> <FLK1B> <FLK2A> <FLK2L	<DRT>	Setting Conditions	
Scaling	Prescaling	P5.bnP											Bank selection ≠ OFF	
	Prescale * X (*: 0-7)	P5ā.Rā											Bank selection ≠ OFF; * is the value between 0 and 7 set for the comparative set value bank.	
	Prescale * Y (*: 0-7)	P5ā.RY											Bank selection ≠ OFF; * is the value between 0 and 7 set for the comparative set value bank.	
	Time unit	dPB											Bank selection ≠ OFF; * is the value between 0 and 7 set for the comparative set value bank.	
	Bank copy	ĒāPY											Bank selection ≠ OFF	
Comparative set value	Comparative set value bank	Su.bnP		●	●	●	●	●					Bank selection ≠ OFF	
	Comparative set value * 5 (*:0 to 7)	Suā.ā5			●	●	●						Bank selection ≠ OFF; * is the value between 0 and 7 set for the comparative set value bank.	
	Comparative set value * 4 (*:0 to 7)	Suā.ā4		●	●	●	●						Bank selection ≠ OFF; * is the value between 0 and 7 set for the comparative set value bank.	
	Comparative set value * 3 (*:0 to 7)	Suā.ā3				●	●	●					Bank selection ≠ OFF; * is the value between 0 and 7 set for the comparative set value bank.	
	Comparative set value * 2 (*:0 to 7)	Suā.ā2		●	●	●	●						Bank selection ≠ OFF; * is the value between 0 and 7 set for the comparative set value bank.	
	Comparative set value * 1 (*:0 to 7)	Suā.ā1			●	●	●						Bank selection ≠ OFF; * is the value between 0 and 7 set for the comparative set value bank.	
	Bank copy	ĒāPY		●	●	●	●	●						Bank selection ≠ OFF
	Linear output	Linear current type	ĒSEē.Ē							●				
Linear voltage type		ĒSEē.ū								●				
Linear output upper limit		ĒSEē.H							●	●				
Linear output lower limit		ĒSEē.L							●	●				
Communica-tions settings	Communica-tions unit No.	ū-nā									●	●		
	Baud rate	bPS									●			
	Communica-tions data length	ĒEn									●			
	Communica-tions stop bits	Sbēē									●			
	Communica-tions parity	P-ēY									●			
	Communica-tions wait time	SdYē									●			
Output test	Test input	ēēSē												
Advanced -function	Set value initial-ization	Ēnēē												
	Output OFF delay	āFF-d		●	●	●	●	●						
	Shot output	SHāē		●	●	●	●	●						
	Output logic	āYē-n		●	●	●	●	●						
	Bank selection	bnP-Ē												

# About Parameters

## K3HB-R

### Power ON

#### Protect level [L P]

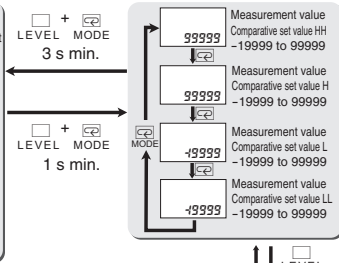
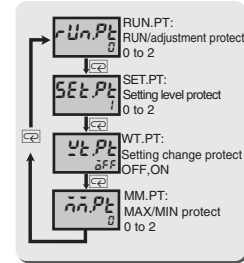

#### Adjustment level [L A]

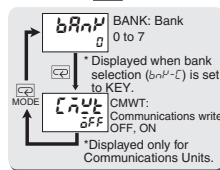

### Initial setting level [L 0]

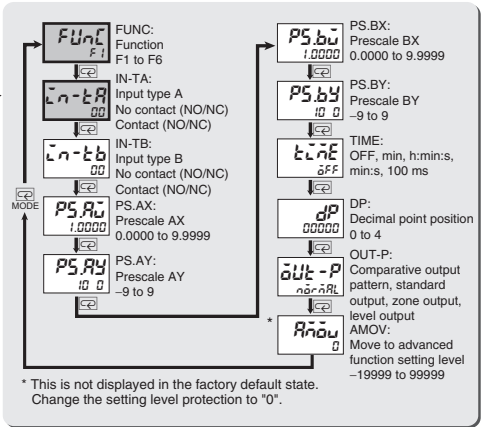

LEVEL 1 s min.

Password: -0169

LEVEL 1 s max.

### Parameter Display

- : Always displayed regardless of model or settings.
- : Displayed only for certain models or settings.

Press the [LEVEL] key for at least 1 s from any display (except for the protect level) to return to the first parameter in the RUN or initial setting level.

### Advanced function setting level [L F]

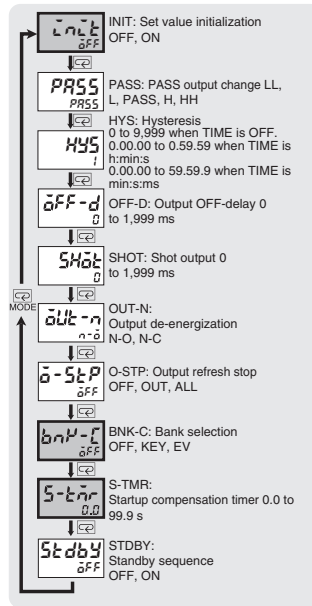

### Output test level [L T]

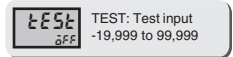

LEVEL 1 s max. Displayed only for Communications Units.

### Communications setting level [L B]

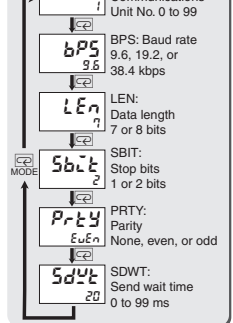

LEVEL 1 s max. Displayed for Linear Output Units only.

### Linear output level [L S]

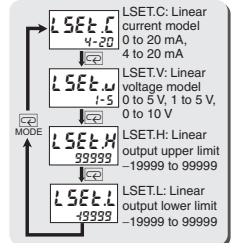

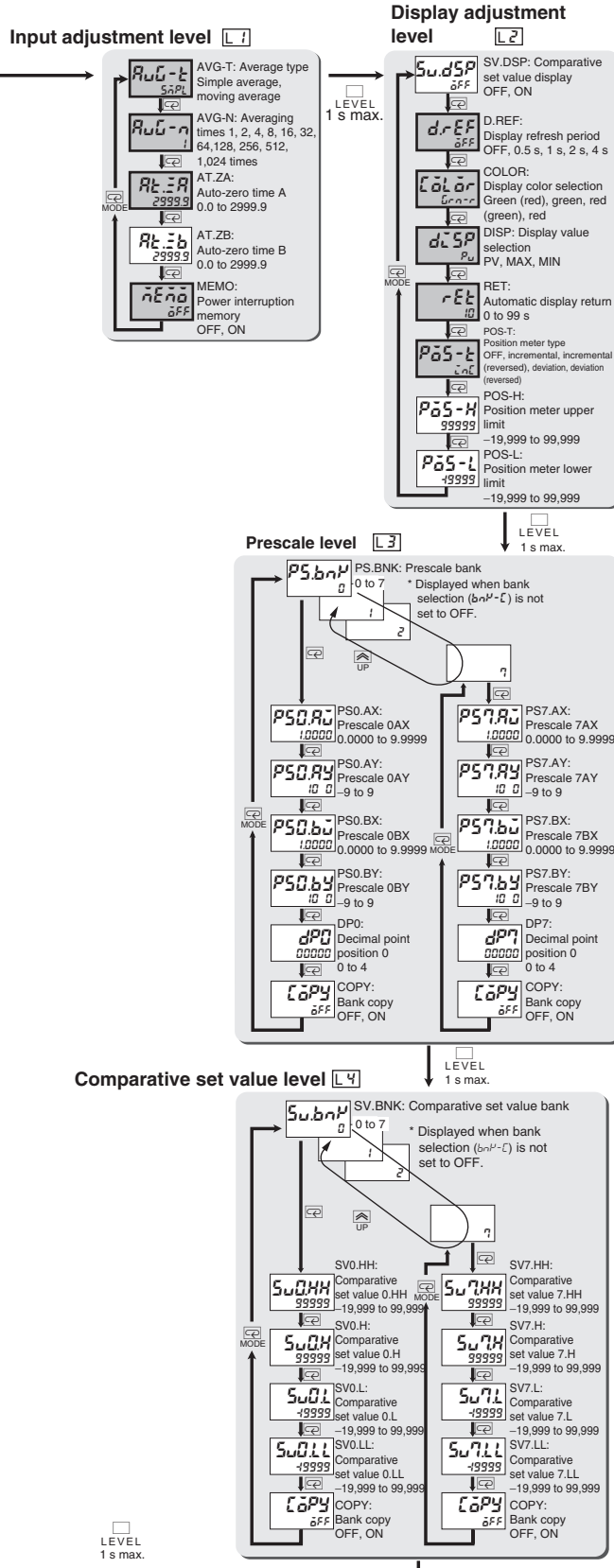



■ K3HB-P

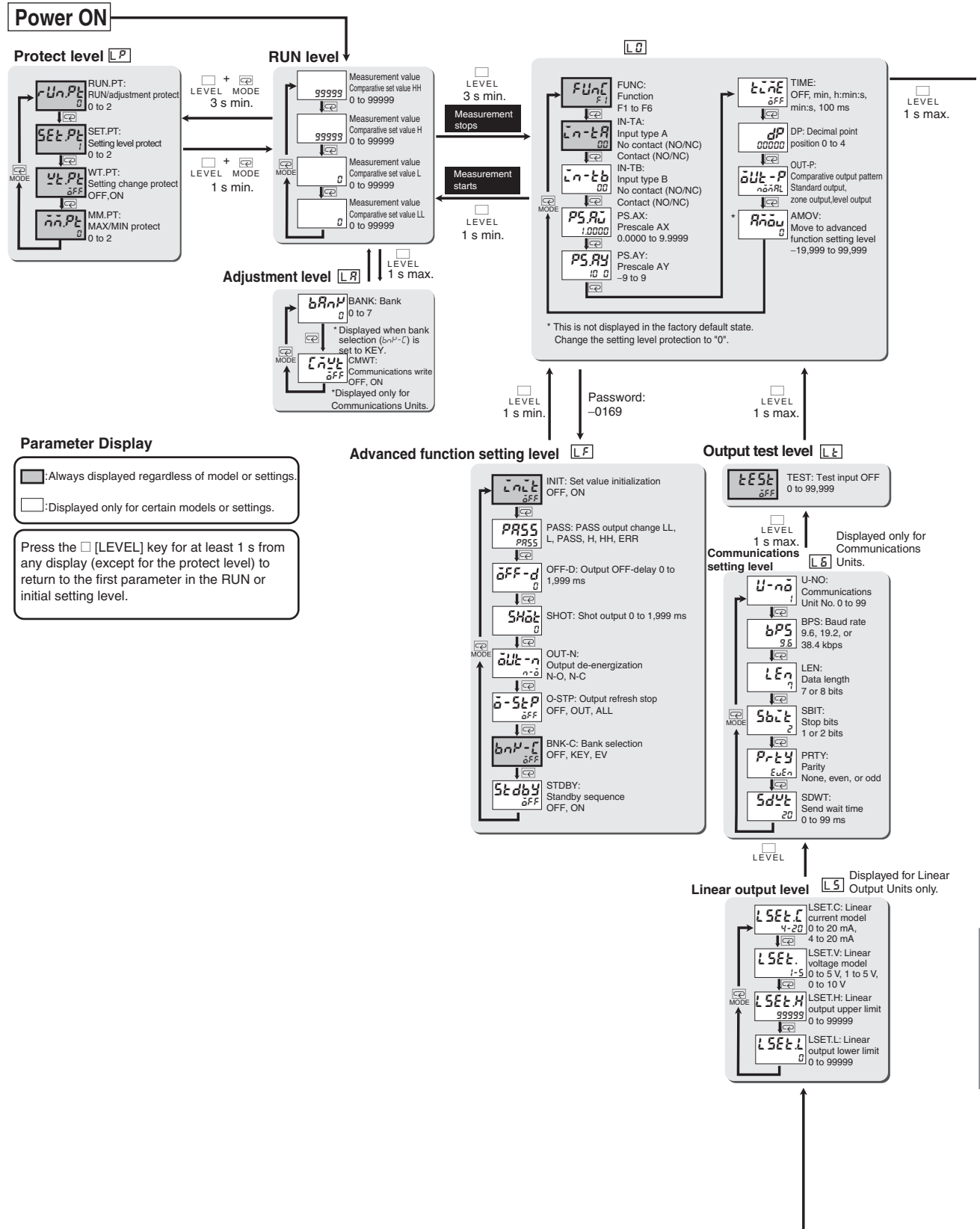

Input adjustment level [L1] Display adjustment level [L2]

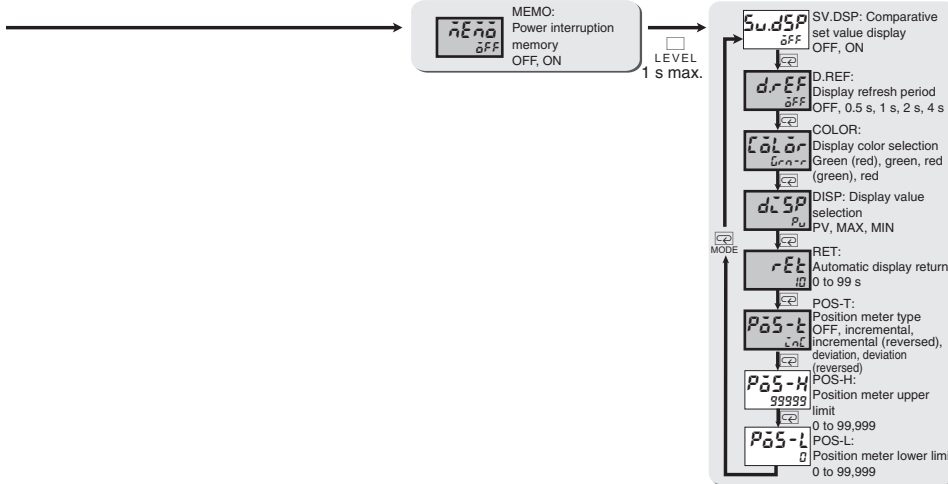

Prescale level [L3]

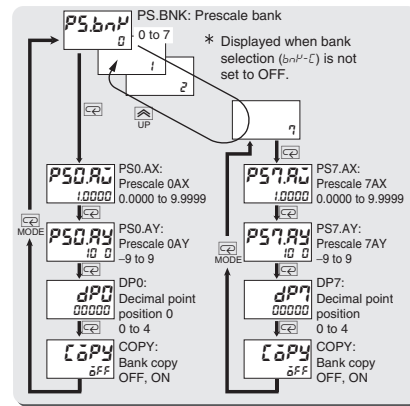

Comparative set value level [L4]

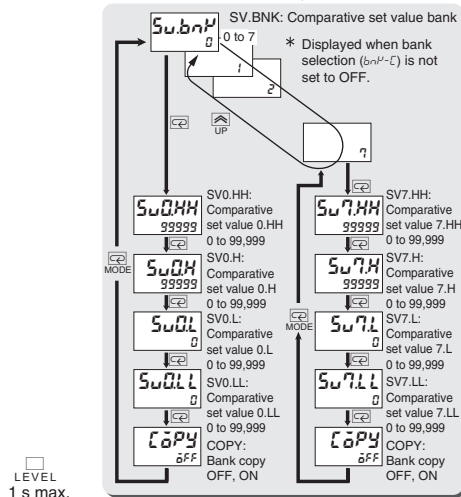

**K3HB-C**

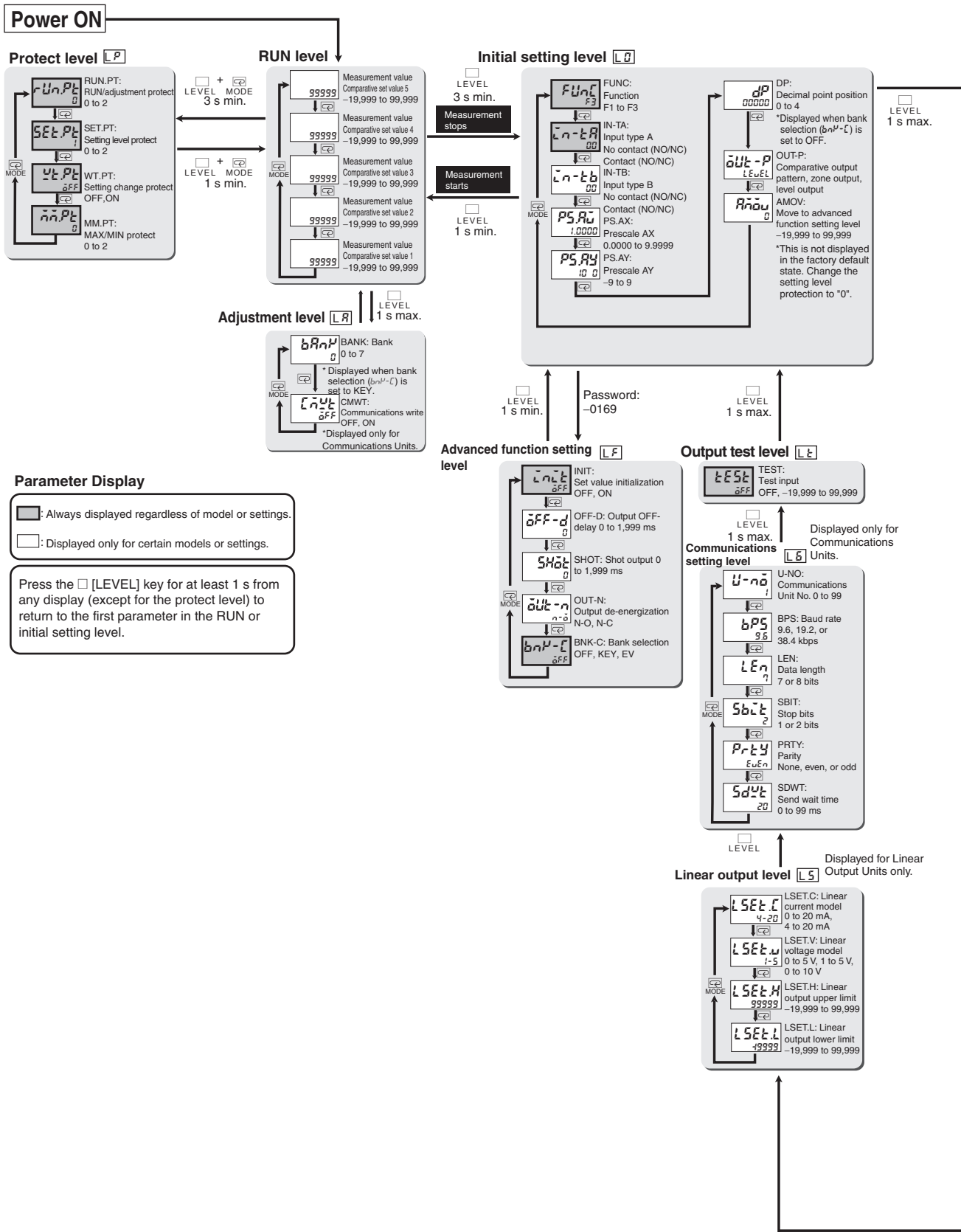

Input adjustment level [L1] Display adjustment level [L2]

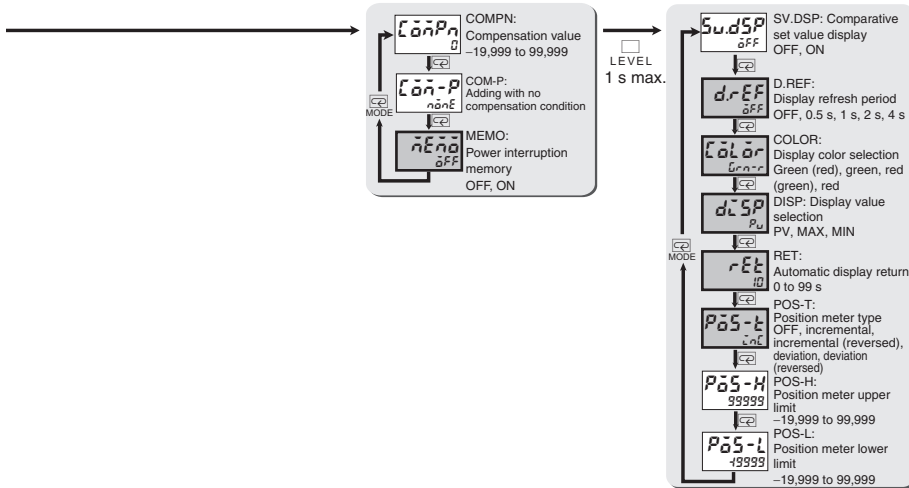

Prescale level [L3]

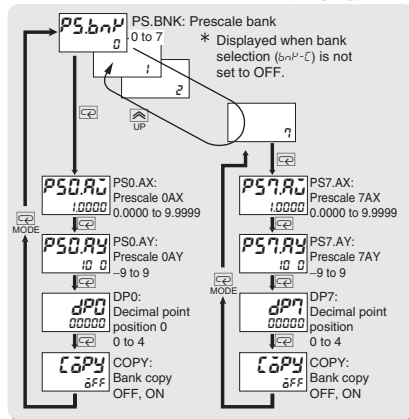

Comparative set value level [L4]

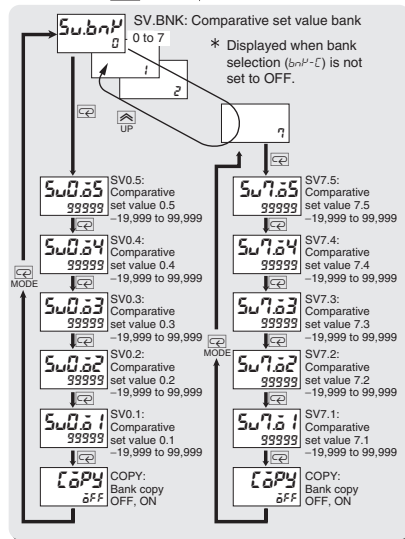

## “No-Measurement” Status

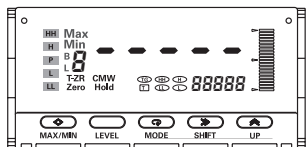

- PV display "-----"
- All outputs OFF

When no measurement value has been determined, a “no-measurement” status exists. The PV display for no measurement is “-----” and all outputs are OFF.

A no-measurement status occurs in the following circumstances.

- When power is turned ON during a RESET input or during startup compensation timer operation.
  - Immediately after returning to RUN level from any level other than the protect and adjustment levels during a RESET input or during startup compensation timer operation.
- \* If the HOLD signal turns ON when no measurement has been made, the no-measurement status is held.

## Forecasted Cycle Calculations

When the input pulse stops suddenly, forecasted cycle calculations are used to wait for the next input pulse based on frequency forecasts. During forecasted cycle calculations, the frequency is forecasted continuously for any point in time regardless of when the next input pulse is received. This increases the response characteristic in the shaded portion of the diagram.

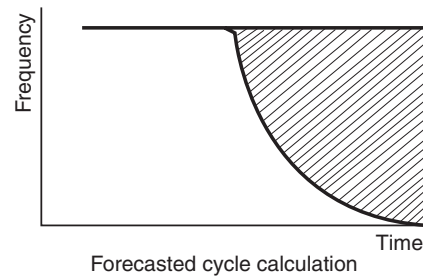

### Forecasted Cycle Calculation

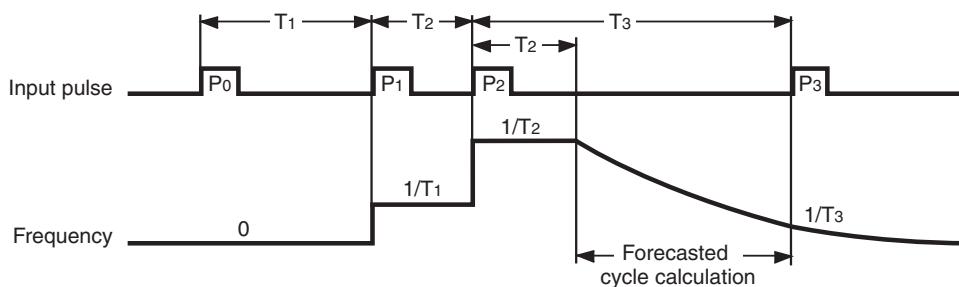

- (1) Frequency calculation is not possible with only pulse  $P_0$ , so the calculated value remains at 0.
- (2) When pulse  $P_1$  is received, the time  $T_1$ , from  $P_0$  to  $P_1$  is the cycle, so the frequency can be calculated as  $1/T_1$ .
- (3) If pulse  $P_2$  is received and  $T_1 > T_2$ , the cycle has shortened (i.e., the frequency has increased), so  $1/T_2$  is used as the frequency at that point.
- (4) If time  $T_2$  expires before the next pulse is received after receiving pulse  $P_2$ , it is clear that the frequency will be lower than  $1/T_2$ , but the value will not be known until the next pulse is actually received.
- (5) If time  $T_2$  expires and the next pulse still has not been received after receiving pulse  $P_2$ , the frequency is forecasted continuously for any point in time. The forecasted value if time  $T_3$  has expired from receiving pulse  $P_2$  is  $1/T_3$ . If  $P_3$  is actually received at that time, the frequency will be  $1/T_3$ , i.e., the frequency at that time has been forecasted accurately.
- (6) The response characteristic for rapid changes in the input frequency is thus improved, in comparison to assuming that the frequency is  $1/T_2$  until pulse  $P_3$  is received.

# INDEX

## A

Adjustment level 5-2, 5-3, 5-4  
 Advanced function setting level 5-2, 5-3, 5-4  
 Advanced function settings 5-5  
 Automatic display return 5-74  
 Auto-zero time 1-2, 5-32  
 Averaging 1-2, 5-37  
 Averaging times 5-37, 5-38  
 Averaging type 3-3, 3-5, 3-8, 5-37, 5-38

## B

Bank copy 1-4, 5-82, 5-83  
 Bank selection 1-4, 5-76  
 Basic application methods -XI, 3-1

## C

Communications setting level 5-3, 5-4  
 Communications settings 5-2  
 Comparative output pattern 1-3, 5-40  
 Comparative output status indicators 1-5, 1-6  
 Comparative outputs 2-7, 5-40  
 Comparative outputs, holding 5-50  
 Comparative set value banks 5-76, 5-82, 5-83  
 Comparative set value display 1-3, 5-69  
 Comparative set value level 5-2, 5-3, 5-4  
 Comparative set values 5-7, 5-40, 5-43, 5-69, 5-75, 5-76  
 COMPENSATION input 5-62, A-2  
 Component names and functions 1-5, 1-6

## D

Decimal point position 5-29, 5-31, 5-78  
 Display adjustment 5-2, 5-61  
 Display adjustment level 5-3, 5-4  
 Display color selection 1-3, 5-70  
 Display refresh period 1-3, 5-61  
 Display value selection 1-3, 5-68  
 Display, returning to RUN level 5-74

## E

Event inputs 2-9, A-2  
 External dimensions 2-2

## F

Function for the K3HB-C 5-24  
 Function for the K3HB-P 5-17  
 Function for the K3HB-R 5-9

## H

HOLD input 1-5, 1-6, 5-17, 5-18, 5-19, 5-20, 5-21, 5-22,  
 5-24, 5-25, 5-26, 5-49, 6-3, A-2  
 Hysteresis 1-3, 5-43, 6-3

## I

Initial setting level 5-2, 5-3, 5-4  
 Initial setup  
   Example for the K3HB-C 4-6  
   Example for the K3HB-P 4-4  
   Example for the K3HB-R 4-2  
 Initializing settings -VIII, 5-84  
 Input adjustment 5-2, 5-3, 5-4  
 Input adjustment level 5-2, 5-3, 5-4  
 Input error 5-54, 5-70  
 Input type 1-2, 5-28  
 Interruption memory 5-64

## K

Key operations, restricting 5-85  
 Key protection 1-2, 5-85

## L

LCD field of vision 2-3  
 LEVEL key 1-5, 1-6  
 Level outputs 5-40, 5-41, A-23, A-25, A-27  
 Level/bank display 1-5, 1-6  
 Linear current type 5-59

Linear output 1-3, 2-6, 5-58  
 Linear output level 5-2, 5-3, 5-4  
 Linear output lower limit 5-58, 5-59  
 Linear output upper limit 5-58, 5-59  
 Linear voltage type 5-59

## M

Max/Min hold 1-4, 5-66  
 MAX/MIN key 1-5, 1-6  
 Max/Min protect 5-86  
 Maximum and minimum values, holding 5-66  
 Measurement status, holding 5-49  
 Measurements, delaying 5-35  
 Measurements, resetting 5-34  
 MODE key 1-5, 1-6  
 Monitoring and changing set values 5-6  
 Mounting method 2-3  
 Moving average 5-37, 5-38

## O

OFF timing delay 5-47  
 Operation 5-2  
 Output chattering 5-43  
 Output logic 1-3, 5-54  
 Output OFF delay 1-3, 5-47  
 Output refresh stop 1-3, 5-50, 6-3  
 Output test 1-3, 5-2, 5-4, 5-75  
 Output test level 5-3, A-23, A-25, A-27  
 Outputs with set intervals 5-45  
 Overflow 5-10, 5-11

## P

Panel cutout dimensions 2-2  
 Parameter display conditions A-8  
 Parameter list A-8  
 PASS output change 1-3, 5-52  
 PASS range and outputs 5-56  
 Position meter 1-3, 1-5, 1-6  
 Position meter lower limit 5-72, 5-73  
 Position meter type 5-72, 5-73  
 Position meter upper limit 5-72, 5-73  
 Power supply 2-5  
 Prescale values 5-29  
 Protect 5-2, 5-3, 5-4

Protect level 5-3, 5-4, 5-85  
 Protection 5-2, 5-85, 6-3  
 PV display 1-5, 1-6

## R

RESET input 5-34, 6-3, A-2, A-29  
 Resetting measurements 5-34  
 RUN level 5-3, 5-4  
 RUN/adjustment protection 5-85, A-8

## S

Scaling 1-3, 5-29, 5-30  
 Sensor power supply 2-5  
 Set values 5-6  
 Setting change protection 5-85  
 Setting initialization 5-84  
 Setting level protection 5-85  
 SHIFT key 1-5, 1-6  
 Shot output 1-3, 5-45  
 Simple average 5-37, 5-38  
 Standard outputs 3-8, 3-10, 3-12, 5-40  
 Standby sequence 1-3, 5-56  
 Startup compensation timer 1-3, 5-35, 6-3, A-2, A-12, A-23, A-25  
 Status indicators 1-5, 1-6  
 SV display 1-5, 1-6  
 SV display status indicators 1-5, 1-6

## T

Teaching 1-2, 5-31

## U

UP key 1-5, 1-6

## W

Wiring 2-5

## Z

Zone outputs 5-40, 5-41, A-23, A-25, A-27





**OMRON Corporation** Industrial Automation Company  
Tokyo, JAPAN

Contact: [www.ia.omron.com](http://www.ia.omron.com)

**Regional Headquarters**

**OMRON EUROPE B.V.**

Wegalaan 67-69-2132 JD Hoofddorp  
The Netherlands  
Tel: (31)2356-81-300/Fax: (31)2356-81-388

**OMRON ELECTRONICS LLC**

One Commerce Drive Schaumburg,  
IL 60173-5302 U.S.A.  
Tel: (1) 847-843-7900/Fax: (1) 847-843-7787

**OMRON ASIA PACIFIC PTE. LTD.**

No. 438A Alexandra Road # 05-05/08 (Lobby 2),  
Alexandra Technopark,  
Singapore 119967  
Tel: (65) 6835-3011/Fax: (65) 6835-2711

**OMRON (CHINA) CO., LTD.**

Room 2211, Bank of China Tower,  
200 Yin Cheng Zhong Road,  
PuDong New Area, Shanghai, 200120, China  
Tel: (86) 21-5037-2222/Fax: (86) 21-5037-2200

**Authorized Distributor:**

© OMRON Corporation 2004 All Rights Reserved.  
In the interest of product improvement,  
specifications are subject to change without notice.

**Cat. No. N136-E1-03**

0913