

2SK413, 2SK414

355-951/963

SILICON N-CANNEL MOS FET

HIGH SPEED POWER SWITCHING,
HIGH FREQUENCY POWER AMPLIFIER
Complementary pair with 2SJ118, 119

FEATURES

- Low On-Resistance
- High Speed Switching
- High Cutoff Frequency
- No Secondary Breakdown
- Suitable for Switching Regulator, DC-DC Converter, PWM Amplifiers, and Ultrasonic Power Oscillators

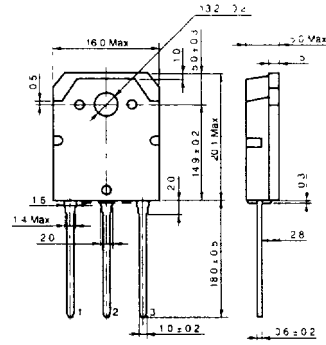
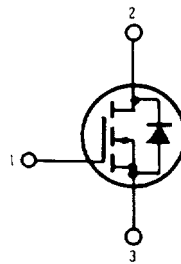

- Gate
 - Drain (Flange)
 - Source
- (Dimensions in mm)

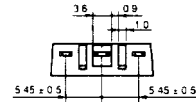

(TO-3P)

ABSOLUTE MAXIMUM RATINGS ($T_c=25^\circ\text{C}$)

Item	Symbol	Rating		Unit
		2SK413	2SK414	
Drain-Source Voltage	V_{DS}	140	160	V
Gate-Source Voltage	V_{GS}	±20		V
Drain Current	I_D	8		A
Drain Peak Current	$I_{D(peak)}$	12		A
Body-Drain Diode Reverse Drain Current	I_{DR}	8		A
Channel Dissipation	P_{ch}^*	100		W
Channel Temperature	T_{ch}	150		$^\circ\text{C}$
Storage Temperature	T_{stg}	-55 ~ +150		$^\circ\text{C}$

* Value at $T_c=25^\circ\text{C}$

POWER VS TEMPERATURE DERATING

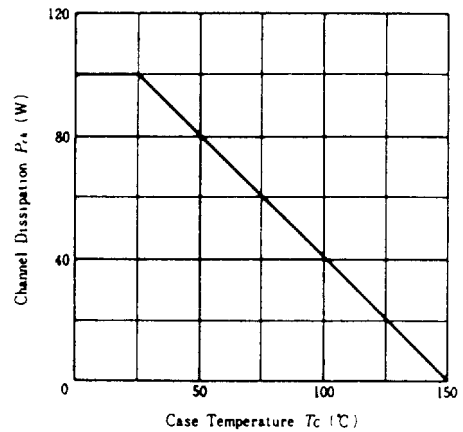

ELECTRICAL CHARACTERISTICS ($T_c=25^\circ\text{C}$)

Item	Symbol	Test Condition	min.	typ	max	Unit
Drain-Source Breakdown Voltage	2SK413	$I_D=10\text{mA}, V_{GS}=0$	140	—	—	V
	2SK414		160	—	—	V
Gate-Source Leak Current	I_{GSS}	$V_{GS}=\pm 20\text{V}, V_{DS}=0$	—	—	±1	μA
Zero Gate Voltage Drain Current	2SK413	$V_{DS}=120\text{V}, V_{GS}=0$	—	—	1	mA
	2SK414		$V_{DS}=140\text{V}, V_{GS}=0$	—	—	1
Gate-Source Cutoff Voltage	$V_{GS(off)}$	$I_D=1\text{mA}, V_{DS}=10\text{V}$	2.0	—	5.0	V
Static Drain-Source On State Resistance	$R_{DS(on)}$	$I_D=4\text{A}, V_{GS}=15\text{V}^*$	—	0.4	0.5	Ω
Drain-Source Saturation Voltage	$V_{DS(on)}$	$I_D=4\text{A}, V_{GS}=15\text{V}^*$	—	1.6	2.0	V
Forward Transfer Admittance	$ y_f $	$I_D=4\text{A}, V_{DS}=10\text{V}^*$	1.0	2.0	—	S
Input Capacitance	C_{iss}	$V_{DS}=10\text{V}, V_{GS}=0$ $f=1\text{MHz}$	—	800	—	pF
Output Capacitance	C_{oss}		—	330	—	pF
Reverse Transfer Capacitance	C_{riss}		—	60	—	pF
Turn-on Delay Time	t_{don}	$I_D=2\text{A}, V_{GS}=15\text{V}$ $R_L=15\Omega$	—	15	—	ns
Rise Time	t_r		—	35	—	ns
Turn-off Delay Time	t_{doff}		—	60	—	ns
Fall Time	t_f		—	50	—	ns
Body-Drain Diode Forward Voltage	V_{DF}	$I_F=4\text{A}, V_{GS}=0$	—	0.9	—	V
Body-Drain Diode Reverse Recovery Time	t_{rr}	$I_F=4\text{A}, V_{GS}=0$ $dI_F/dt=50\text{A}/\mu\text{s}$	—	250	—	ns

* Pulse Test

MAXIMUM SAFE OPERATION AREA

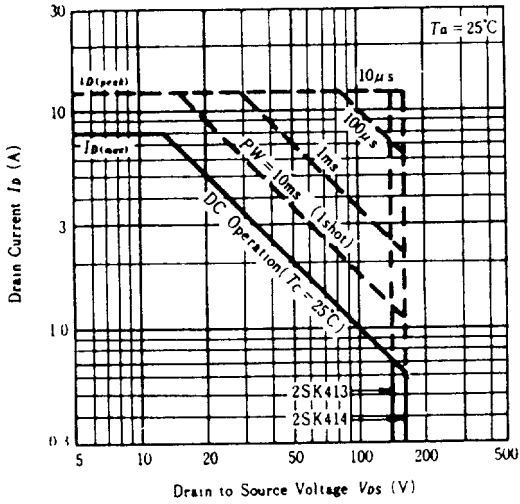

TYPICAL OUTPUT CHARACTERISTICS

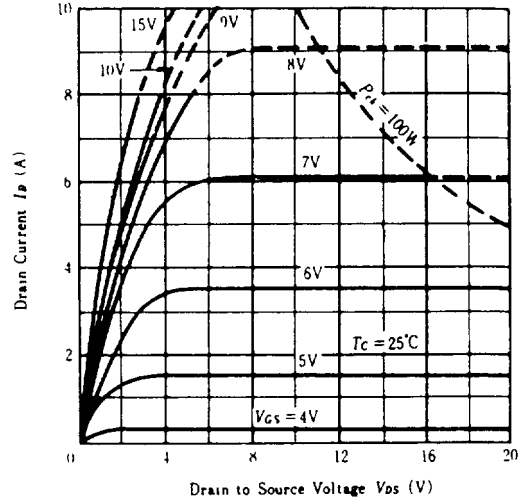

TYPICAL TRANSFER CHARACTERISTICS

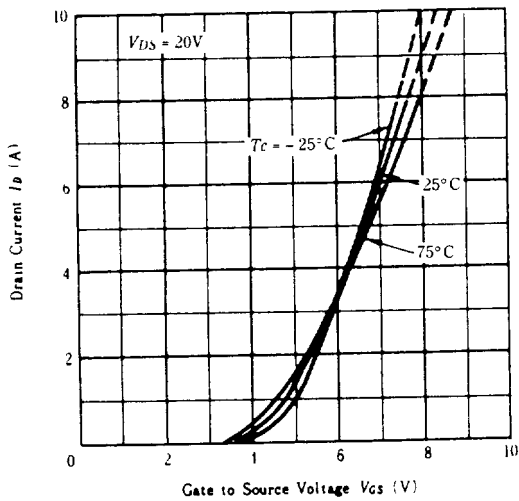

DRAIN-SOURCE SATURATION VOLTAGE VS GATE-SOURCE VOLTAGE

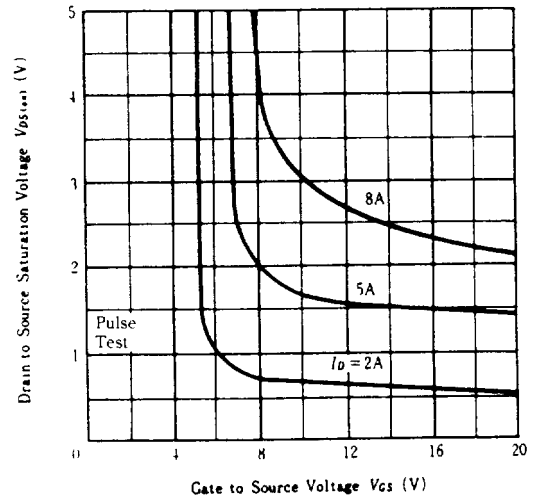

FORWARD TRANSFER ADMITTANCE VS DRAIN CURRENT

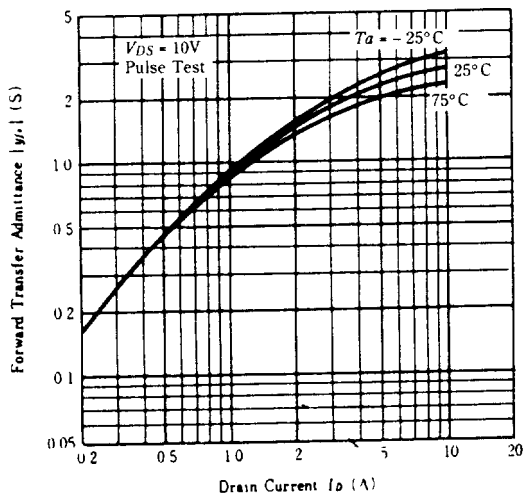

STATIC DRAIN-SOURCE ON STATE RESISTANCE VS TEMPERATURE

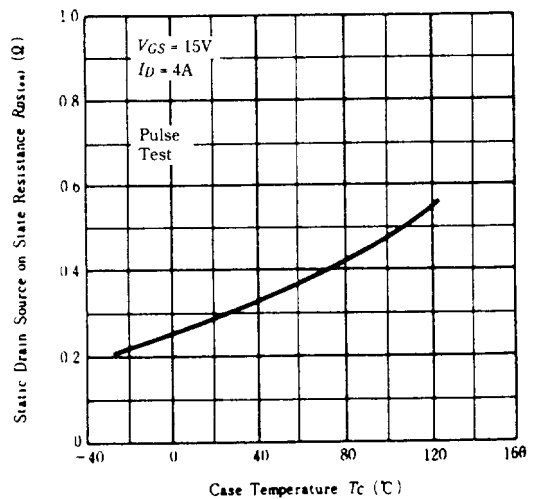

TYPICAL CAPACITANCE VS. DRAIN-SOURCE VOLTAGE

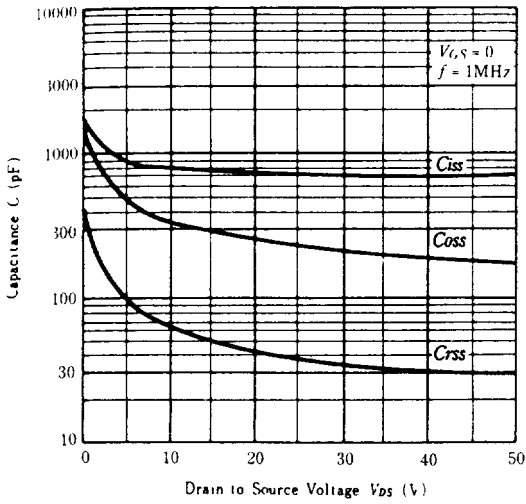

FORWARD TRANSFER ADMITTANCE VS FREQUENCY

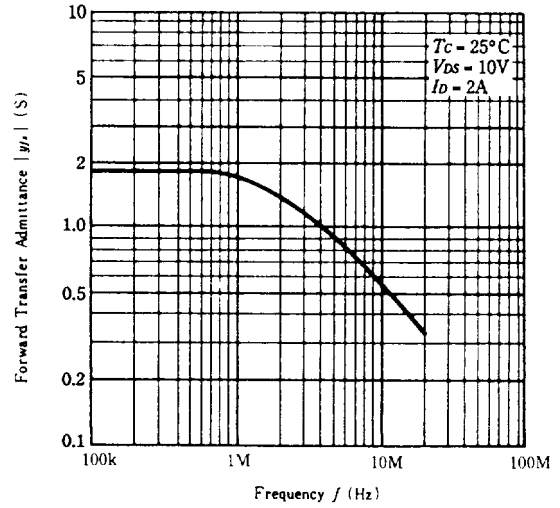

SWITCHING CHARACTERISTICS

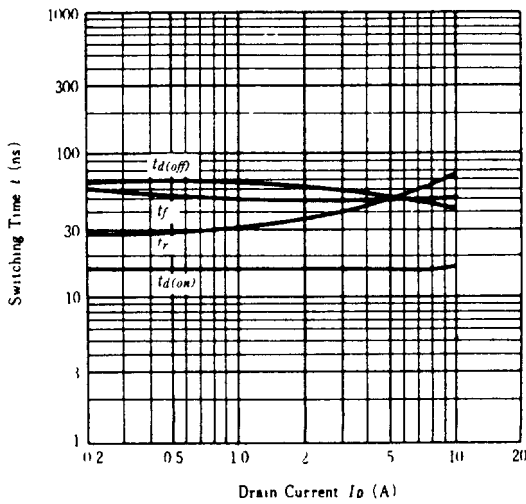

MAXIMUM BODY-DRAIN DIODE FORWARD VOLTAGE

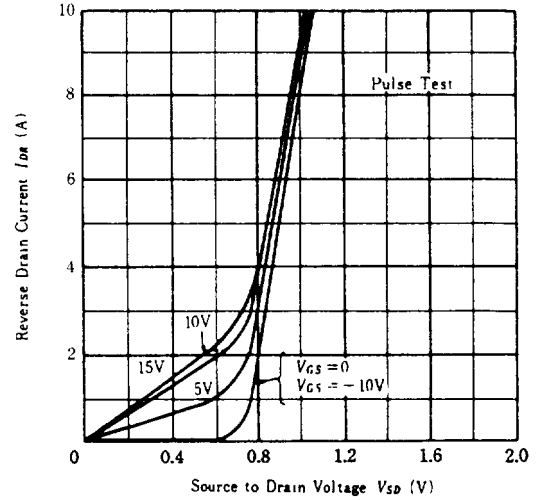

DYNAMIC INPUT CHARACTERISTICS

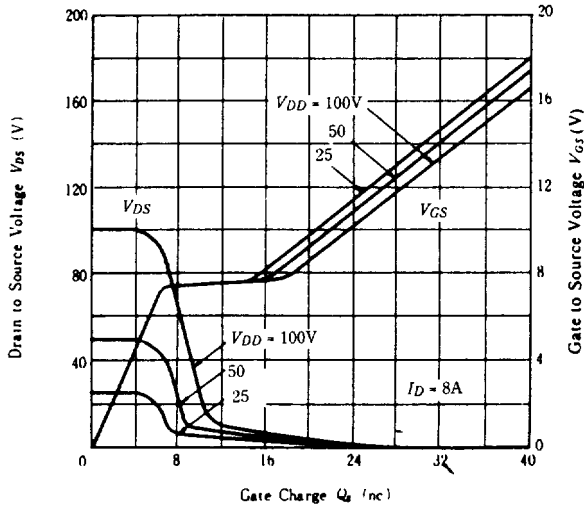

SWITCHING TIME TEST CIRCUIT

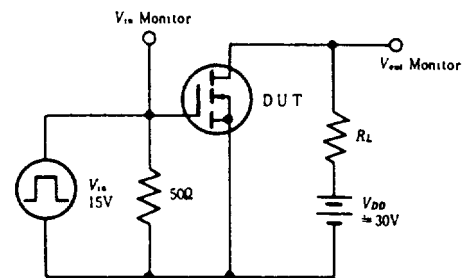

WAVEFORMS

