

**K4N35 • K4N36 • K4N37**

These Photocouplers consist of a Gallium Arsenide Infrared Emitting Diode and a Silicon NPN Phototransistor in 6-pin package.

**FEATURES**

- Switching Time - Typ. 3 $\mu$ s
- Collector-Emitter Voltage : Min.30V
- Current Transfer Ratio : Typ.100% (at  $I_F=10\text{mA}$ ,  $V_{CE}=10\text{V}$ )
- Electrical Isolation Voltage : AC2500V<sub>rms</sub>
- UL Recognized File No. E107486

**APPLICATIONS**

- Interface between two circuits of different potential
- Vending Machine, Voltage Regulator
- Traffic Controller System
- Programmable Controller

**DIMENSION**

(Unit : mm)

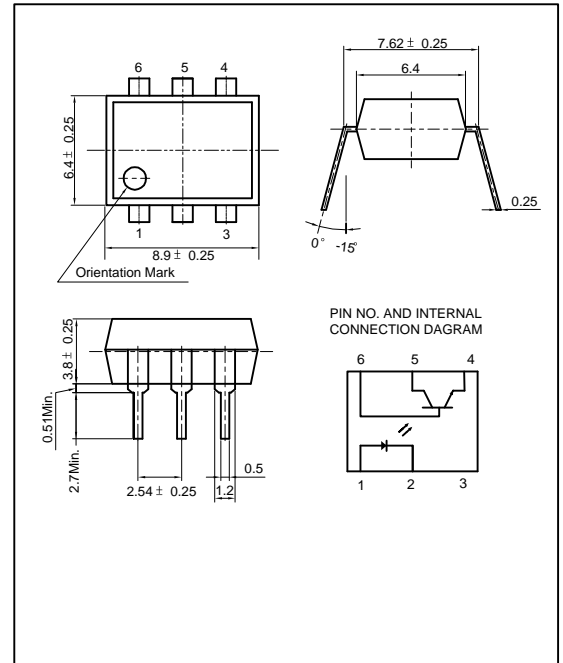

**MAXIMUM RATINGS**

( $T_a=25$  )

Parameter		Symbol	Rating	Unit
Input	Forward Current	$I_F$	60	mA
	Reverse Voltage	$V_R$	5	V
	Peak Forward Current <sup>*1</sup>	$I_{FP}$	3	A
	Power Dissipation	$P_D$	70	mW
Output	Collector-Emitter Breakdown Voltage	$BV_{CEO}$	35 <sup>*4</sup>	V
	Emitter-Collector Breakdown Voltage	$BV_{ECO}$	6	V
	Collector-Base Breakdown Voltage	$BV_{CBO}$	70	V
	Collector Current	$I_C$	50	mA
	Collector Power Dissipation	$P_C$	150	mW
Input to Output Isolation Voltage <sup>*2</sup>		$V_{iso}$	AC2500	$V_{rms}$
Storage Temperature		$T_{stg}$	-55~+125	
Operating Temperature		$T_{opr}$	-30~+100	
Lead Soldering Temperature <sup>*3</sup>		$T_{sol}$	260	
Total Power Dissipation		$P_{tot}$	200	mW

\*1. Input current with 100 $\mu$ s pulse width, 1% duty cycle  
 \*2. Measured at RH=40~60% for 1min  
 \*3. 1/16 inch form case for 10sec  
 \*4. Customer Option

# K4N35 • K4N36 • K4N37

## ELECTRO-OPTICAL CHARACTERISTICS

(Ta=25 , unless otherwise noted)

Parameter		Symbol	Condition	Min.	Typ.	Max.	Unit.
Input	Forward Voltage	V <sub>F</sub>	I <sub>F</sub> =10mA	-	1.15	1.30	V
	Reverse Current	I <sub>R</sub>	V <sub>R</sub> =5V	-	-	10	μA
	Capacitance	C <sub>T</sub>	V=0, f=1MHz	-	30	-	pF
Output	Collector-Emitter Breakdown Voltage	BV <sub>CEO</sub>	I <sub>c</sub> =1mA	35	-	-	V
	Emitter-Collector Breakdown Voltage	BV <sub>ECO</sub>	I <sub>E</sub> =0.1mA	6	-	-	V
	Collector-Base Breakdown Voltage	BV <sub>CBO</sub>	I <sub>c</sub> =0.1mA	70	-	-	V
	Collector Dark Current	I <sub>CEO</sub>	I <sub>F</sub> =0, V <sub>CE</sub> =10V	-	-	50	nA
	Capacitance	C <sub>CE</sub>	V <sub>CE</sub> =0, f=1MHz	-	10	-	pF
Coupled	Current Transfer Ratio <sup>*5</sup>	CTR	I <sub>F</sub> =10mA, V <sub>CE</sub> =10V	100	-	-	%
	Collector-Emitter Saturation Voltage	V <sub>CE(SAT)</sub>	I <sub>F</sub> =10mA, I <sub>c</sub> =0.5mA	-	0.15	0.3	V
	Input-Output Capacitance	C <sub>IO</sub>	V=0, f=1MHz	-	1	-	pF
	Input-Output Isolation Resistance	R <sub>IO</sub>	RH=40~60%, V=500V	-	10 <sup>11</sup>	-	
	Rise Time	t <sub>r</sub>	V <sub>CC</sub> =10V, R <sub>L</sub> =100	-	3	10	
	Fall Time	t <sub>f</sub>		I <sub>c</sub> =2mA	-	3	10

\*5. CTR=(I<sub>c</sub>/I<sub>F</sub>) X 100 (%)

K4N35 • K4N36 • K4N37

**Forward Current vs. Ambient Temperature**

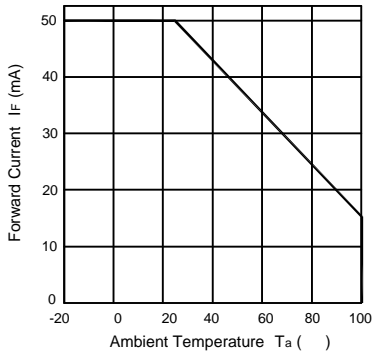

**Collector Power Dissipation vs. Ambient Temperature**

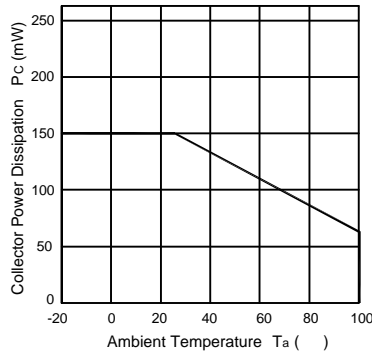

**Forward Current vs. Forward Voltage**

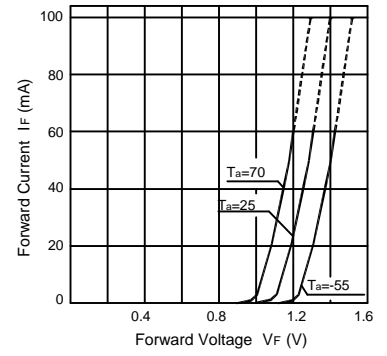

**Collector Current vs. Collector-Emitter Voltage**

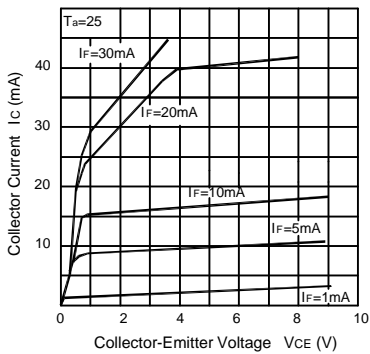

**Dark Current vs. Ambient Temperature**

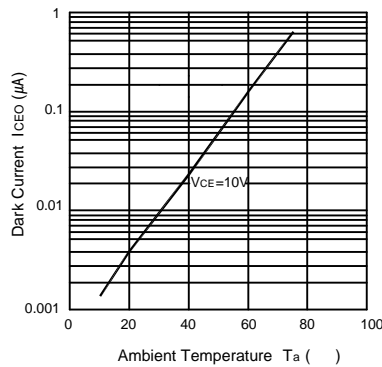

**Collector Current vs. Ambient Temperature**

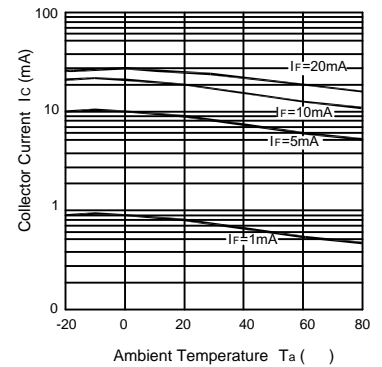

**Response Time vs. Load Resistance**

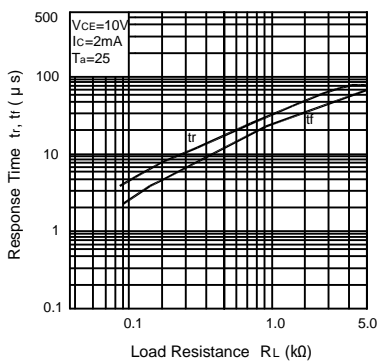

**Collector Current vs. Forward Current**

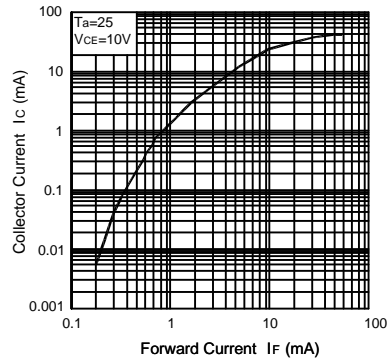

**Switching Time Test Circuit**

