

# 128Mb 0-die SDRAM

54TSOP(II) with Lead-Free & Halogen-Free  
(RoHS compliant)

## datasheet

SAMSUNG ELECTRONICS RESERVES THE RIGHT TO CHANGE PRODUCTS, INFORMATION AND SPECIFICATIONS WITHOUT NOTICE.

Products and specifications discussed herein are for reference purposes only. All information discussed herein is provided on an "AS IS" basis, without warranties of any kind.

This document and all information discussed herein remain the sole and exclusive property of Samsung Electronics. No license of any patent, copyright, mask work, trademark or any other intellectual property right is granted by one party to the other party under this document, by implication, estoppel or otherwise.

Samsung products are not intended for use in life support, critical care, medical, safety equipment, or similar applications where product failure could result in loss of life or personal or physical harm, or any military or defense application, or any governmental procurement to which special terms or provisions may apply.

For updates or additional information about Samsung products, contact your nearest Samsung office.

All brand names, trademarks and registered trademarks belong to their respective owners.

© 2010 Samsung Electronics Co., Ltd. All rights reserved.

## Revision History

| <u>Revision No.</u> | <u>History</u>        | <u>Draft Date</u> | <u>Remark</u> | <u>Editor</u> |
|---------------------|-----------------------|-------------------|---------------|---------------|
| 1.0                 | - First Spec. Release | May. 2010         | -             | S.H.Kim       |

[Table Of Contents](#)

128Mb 0-die SDRAM

|   |    |
|---|----|
| 1. KEY FEATURES.....                            | 4  |
| 2. GENERAL DESCRIPTION .....                    | 4  |
| 3. ORDERING INFORMATION .....                   | 4  |
| 4. PACKAGE PHYSICAL DIMENSION .....             | 5  |
| 5. FUNCTIONAL BLOCK DIAGRAM .....               | 6  |
| 6. PIN CONFIGURATION (TOP VIEW).....            | 7  |
| 7. INPUT/OUTPUT FUNCTION DESCRIPTION .....      | 7  |
| 8. ABSOLUTE MAXIMUM RATINGS .....               | 8  |
| 9. DC OPERATING CONDITIONS .....                | 8  |
| 10. CAPACITANCE .....                           | 8  |
| 11. DC CHARACTERISTICS (x8).....                | 9  |
| 12. DC CHARACTERISTICS (x16).....               | 10 |
| 13. AC OPERATING TEST CONDITIONS .....          | 11 |
| 14. OPERATING AC PARAMETER .....                | 12 |
| 15. AC CHARACTERISTICS .....                    | 13 |
| 16. DQ BUFFER OUTPUT DRIVE CHARACTERISTICS..... | 13 |
| 17. IBIS SPECIFICATION.....                     | 14 |
| 18. SIMPLIFIED TRUTH TABLE .....                | 18 |

## 1. KEY FEATURES

- JEDEC standard 3.3V power supply
- LVTTTL compatible with multiplexed address
- Four banks operation
- MRS cycle with address key programs
  - . CAS latency (2 & 3)
  - . Burst length (1, 2, 4, 8 & Full page)
  - . Burst type (Sequential & Interleave)
- All inputs are sampled at the positive going edge of the system clock.
- Burst read single-bit write operation
- DQM (x8) & L(U)DQM (x16) for masking
- Auto & self refresh
- 64ms refresh period (4K Cycle)
- 54pin TSOP II **Lead-Free and Halogen-Free** package
- **RoHS compliant**

## 2. GENERAL DESCRIPTION

The K4S280832O / K4S281632O is 134,217,728 bits synchronous high data rate Dynamic RAM organized as 4 x 4,194,304 words by 8 bits / 4 x 2,097,152 words by 16 bits, fabricated with SAMSUNG's high performance CMOS technology. Synchronous design allows precise cycle control with the use of system clock I/O transactions are possible on every clock cycle. Range of operating frequencies, programmable burst length and programmable latencies allow the same device to be useful for a variety of high bandwidth, high performance memory system applications.

## 3. ORDERING INFORMATION

| Part No.          | Organization | Max Freq.     | Interface | Package   |
|-------------------|--------------|---------------|-----------|---|
| K4S280832O-LC/L75 | 16Mb x 8     | 133MHz (CL=3) | LVTTTL    | 54pin TSOP(II)<br><b>Lead-Free &amp; Halogen-Free</b> |
| K4S280832O-LC/L60 | 16Mb x 8     | 166MHz (CL=3) |           |   |
| K4S281632O-LC/L75 | 8Mb x 16     | 133MHz (CL=3) |           |   |
| K4S281632O-LC/L60 | 8Mb x 16     | 166MHz (CL=3) |           |   |

[ Table 1 ] Row & Column address configuration

| Organization | Row Address | Column Address |
|--------------|-------------|----------------|
| 16Mx8        | A0~A11      | A0-A9          |
| 8Mx16        | A0~A11      | A0-A8          |

4. PACKAGE PHYSICAL DIMENSION

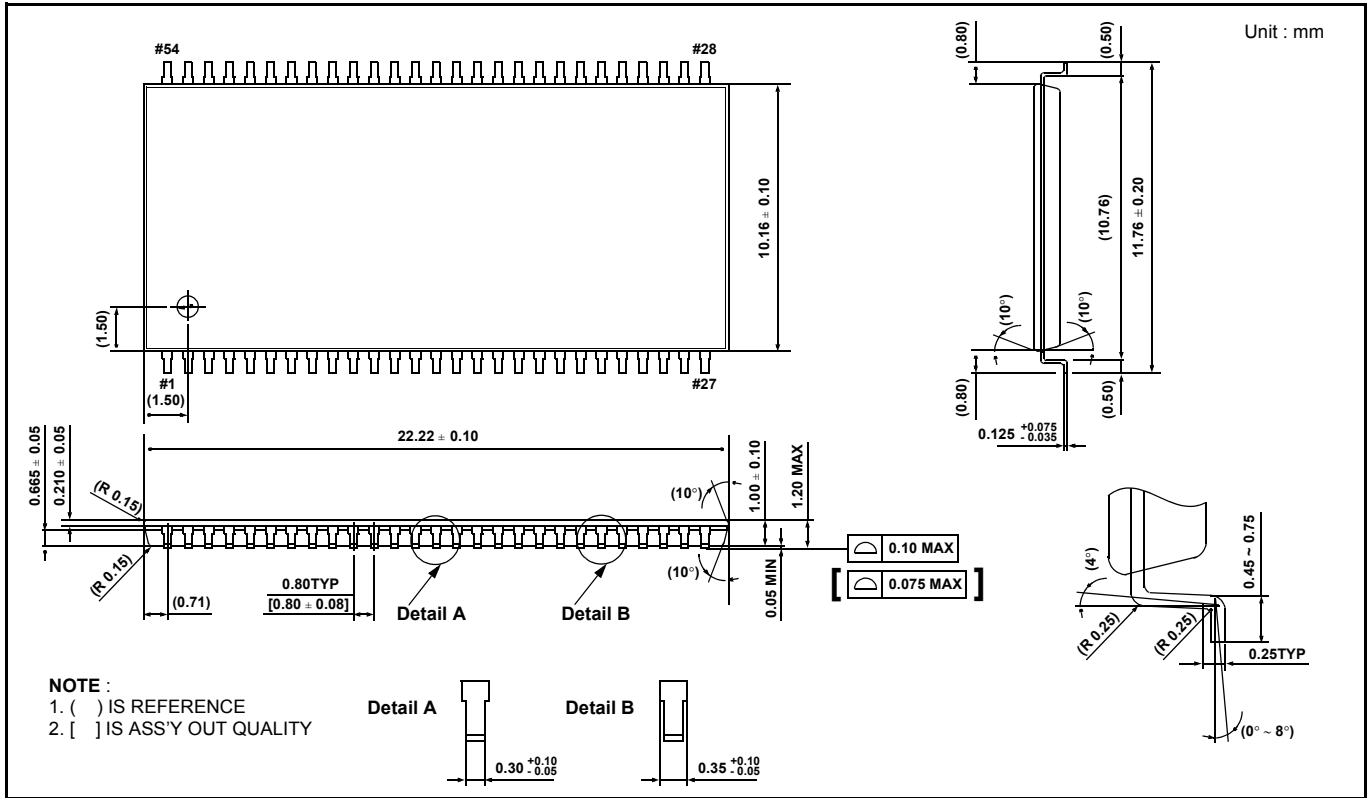
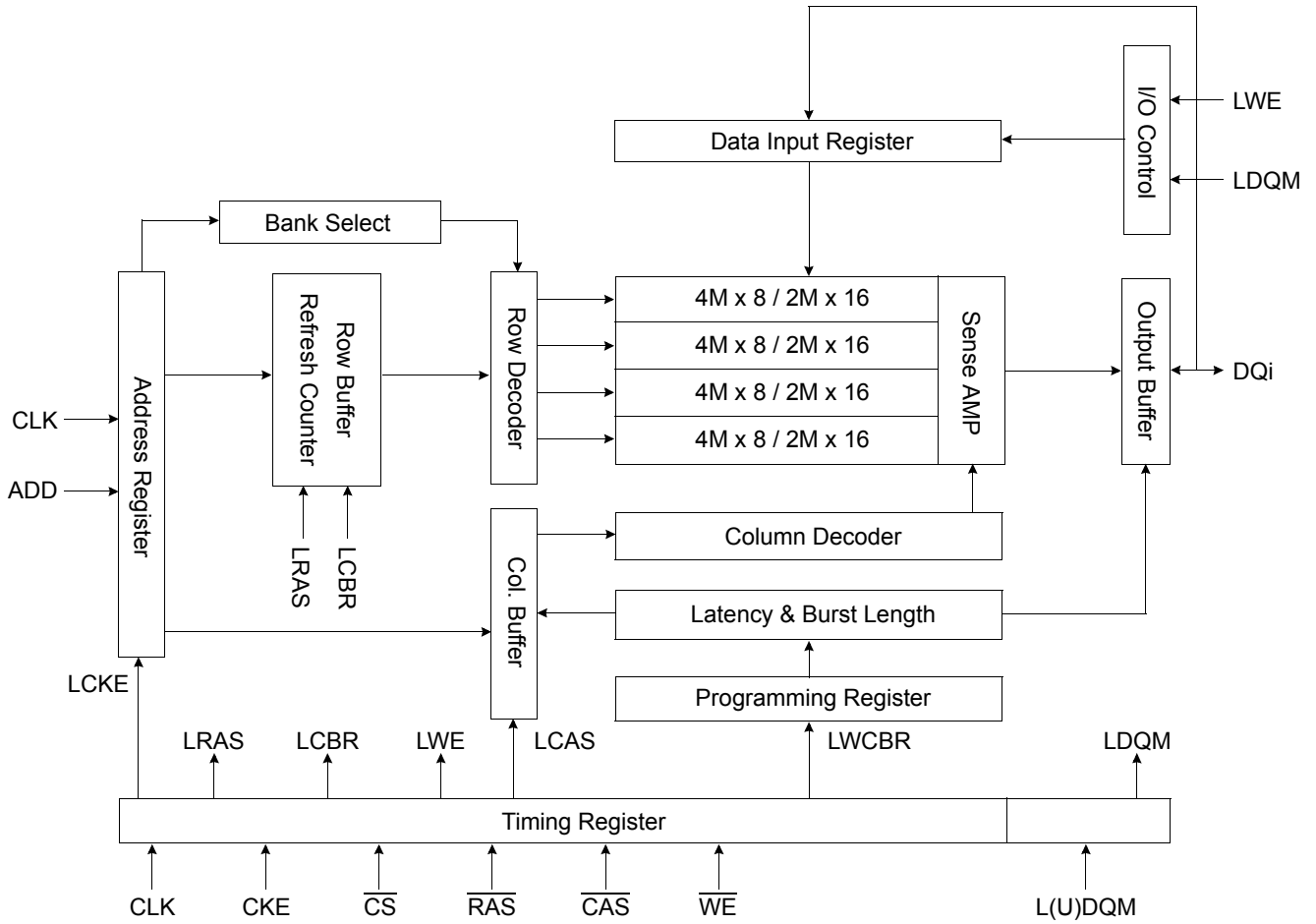

Figure 1. 54Pin TSOP(II) Package Dimension

5. FUNCTIONAL BLOCK DIAGRAM



\* Samsung Electronics reserves the right to change products or specification without notice.

## 6. PIN CONFIGURATION (TOP VIEW)

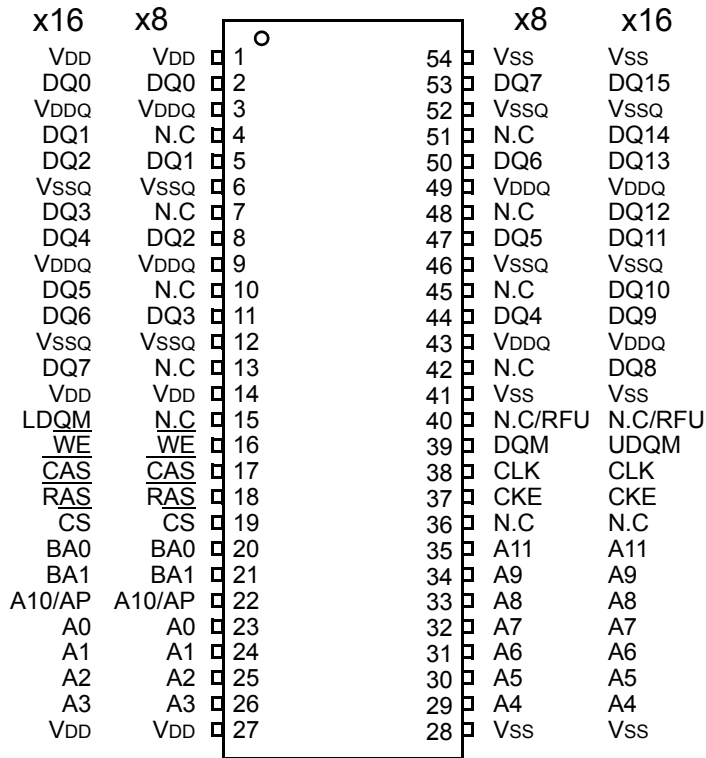

54Pin TSOP  
(400mil x 875mil)  
(0.8 mm Pin pitch)

## 7. INPUT/OUTPUT FUNCTION DESCRIPTION

| Pin                     | Name                                      | Description   |
|-------------------------|---|---|
| CLK                     | System clock                              | Active on the positive going edge to sample all inputs.   |
| $\overline{\text{CS}}$  | Chip select                               | Disables or enables device operation by masking or enabling all inputs except CLK, CKE and DQM  |
| CKE                     | Clock enable                              | Masks system clock to freeze operation from the next clock cycle. CKE should be enabled at least one cycle prior to new command. Disable input buffers for power down in standby. |
| A0 ~ A11                | Address                                   | Row/column addresses are multiplexed on the same pins.<br>Row address : RA0 ~ RA11,<br>Column address : (x8 : CA0 ~ CA9), (x16 : CA0 ~ CA8)                                       |
| BA0 ~ BA1               | Bank select address                       | Selects bank to be activated during row address latch time.<br>Selects bank for read/write during column address latch time.  |
| $\overline{\text{RAS}}$ | Row address strobe                        | Latches row addresses on the positive going edge of the CLK with $\overline{\text{RAS}}$ low. Enables row access & precharge.   |
| $\overline{\text{CAS}}$ | Column address strobe                     | Latches column addresses on the positive going edge of the CLK with $\overline{\text{CAS}}$ low. Enables column access.   |
| $\overline{\text{WE}}$  | Write enable                              | Enables write operation and row precharge. Latches data in starting from CAS, $\overline{\text{WE}}$ active.  |
| DQM                     | Data input/output mask                    | Makes data output Hi-Z, tSHZ after the clock and masks the output. Blocks data input when DQM active.   |
| DQ0 ~ N                 | Data input/output                         | Data inputs/outputs are multiplexed on the same pins.<br>(x8 : DQ0 ~ 7), (x16 : DQ0 ~ 15)   |
| VDD/Vss                 | Power supply/ground                       | Power and ground for the input buffers and the core logic.  |
| VDDQ/Vssq               | Data output power/ground                  | Isolated power supply and ground for the output buffers to provide improved noise immunity.   |
| N.C/RFU                 | No connection<br>/reserved for future use | This pin is recommended to be left No Connection on the device.   |

## 8. ABSOLUTE MAXIMUM RATINGS

| Parameter                                       | Symbol            | Value      | Unit |
|---|-------------------|------------|------|
| Voltage on any pin relative to $V_{SS}$         | $V_{IN}, V_{OUT}$ | -1.0 ~ 4.6 | V    |
| Voltage on $V_{DD}$ supply relative to $V_{SS}$ | $V_{DD}, V_{DDQ}$ | -1.0 ~ 4.6 | V    |
| Storage temperature                             | $T_{STG}$         | -55 ~ +150 | °C   |
| Power dissipation                               | $P_D$             | 1          | W    |
| Short circuit current                           | $I_{OS}$          | 50         | mA   |

**NOTE** : Permanent device damage may occur if "ABSOLUTE MAXIMUM RATINGS" are exceeded.  
Functional operation should be restricted to recommended operating condition.  
Exposure to higher than recommended voltage for extended periods of time could affect device reliability.

## 9. DC OPERATING CONDITIONS

Recommended operating conditions (Voltage referenced to  $V_{SS} = 0V$ ,  $T_A = 0$  to  $70^\circ C$ )

| Parameter                 | Symbol            | Min  | Typ | Max          | Unit | NOTE            |
|---------------------------|-------------------|------|-----|--------------|------|-----------------|
| Supply voltage            | $V_{DD}, V_{DDQ}$ | 3.0  | 3.3 | 3.6          | V    |                 |
| Input logic high voltage  | $V_{IH}$          | 2.0  | 3.0 | $V_{DD}+0.3$ | V    | 1               |
| Input logic low voltage   | $V_{IL}$          | -0.3 | 0   | 0.8          | V    | 2               |
| Output logic high voltage | $V_{OH}$          | 2.4  | -   | -            | V    | $I_{OH} = -2mA$ |
| Output logic low voltage  | $V_{OL}$          | -    | -   | 0.4          | V    | $I_{OL} = 2mA$  |
| Input leakage current     | $I_{LI}$          | -10  | -   | 10           | uA   | 3               |

**NOTE** :  
1.  $V_{IH}$  (max) = 5.6V AC. The overshoot voltage duration is  $\leq 3ns$ .  
2.  $V_{IL}$  (min) = -2.0V AC. The undershoot voltage duration is  $\leq 3ns$ .  
3. Any input  $0V \leq V_{IN} \leq V_{DDQ}$ .  
Input leakage currents include Hi-Z output leakage for all bi-directional buffers with Tri-State outputs.

## 10. CAPACITANCE

( $V_{DD} = 3.3V$ ,  $T_A = 23^\circ C$ ,  $f = 1MHz$ ,  $V_{REF} = 1.4V \pm 200 mV$ )

| Pin  | Symbol | Min | Max | Unit |
|--|--------|-----|-----|------|
| Clock  | CCLK   | 2.5 | 3.5 | pF   |
| $\overline{RAS}$ , $\overline{CAS}$ , $\overline{WE}$ , $\overline{CS}$ , CKE, DQM | CIN    | 2.5 | 3.8 | pF   |
| Address  | CADD   | 2.5 | 3.8 | pF   |
| (x8 : DQ0 ~ DQ7), (x16 : DQ0 ~ DQ15)   | COUT   | 4.0 | 6.0 | pF   |



## 11. DC CHARACTERISTICS (x8)

(Recommended operating condition unless otherwise noted, TA = 0 to 70°C)

| Parameter   | Symbol | Test Condition   | Version |     | Unit | NOTE |
|---|--------|--|---------|-----|------|------|
|   |        |  | 60      | 75  |      |      |
| Operating current<br>(One bank active)                                | ICC1   | Burst length = 1<br>$t_{RC} \geq t_{RC}(\min)$<br>$I_O = 0 \text{ mA}$   | 40      | 40  | mA   | 1    |
| Precharge standby current in<br>power-down mode                       | ICC2P  | $CKE \leq V_{IL}(\max)$ , $t_{CC} = 10\text{ns}$   | 2       | 2   | mA   |      |
|   | ICC2PS | $CKE \ \& \ CLK \leq V_{IL}(\max)$ , $t_{CC} = \infty$   | 2       | 2   |      |      |
| Precharge standby current in non<br>power-down mode                   | ICC2N  | $CKE \geq V_{IH}(\min)$ , $\overline{CS} \geq V_{IH}(\min)$ , $t_{CC} = 10\text{ns}$<br>Input signals are changed one time during 20ns | 15      | 15  | mA   |      |
|   | ICC2NS | $CKE \geq V_{IH}(\min)$ , $CLK \leq V_{IL}(\max)$ , $t_{CC} = \infty$<br>Input signals are stable                                      | 10      | 10  |      |      |
| Active standby current in power-<br>down mode                         | ICC3P  | $CKE \leq V_{IL}(\max)$ , $t_{CC} = 10\text{ns}$   | 5       | 5   | mA   |      |
|   | ICC3PS | $CKE \ \& \ CLK \leq V_{IL}(\max)$ , $t_{CC} = \infty$   | 5       | 5   |      |      |
| Active standby current in<br>non power-down mode<br>(One bank active) | ICC3N  | $CKE \geq V_{IH}(\min)$ , $\overline{CS} \geq V_{IH}(\min)$ , $t_{CC} = 10\text{ns}$<br>Input signals are changed one time during 20ns | 25      | 25  | mA   |      |
|   | ICC3NS | $CKE \geq V_{IH}(\min)$ , $CLK \leq V_{IL}(\max)$ , $t_{CC} = \infty$<br>Input signals are stable                                      | 20      | 20  | mA   |      |
| Operating current<br>(Burst mode)                                     | ICC4   | $I_O = 0 \text{ mA}$<br>Page burst<br>4Banks Activated<br>$t_{CCD} = 2CLKs$  | 60      | 60  | mA   | 1    |
| Refresh current   | ICC5   | $t_{RC} \geq t_{RC}(\min)$   | 100     | 100 | mA   | 2    |
| Self refresh current  | ICC6   | $CKE \leq 0.2V$  | C       | 2   | mA   | 3    |
|   |        |  | L       | 0.8 | 0.8  | mA   |

**NOTE :**

1. Measured with outputs open.
2. Refresh period is 64ms.
3. K4S280832O-LC
4. K4S280832O-LL
5. Unless otherwise noticed, input swing level is CMOS( $V_{IH}/V_{IL} = V_{DDQ}/V_{SSQ}$ ).

## 12. DC CHARACTERISTICS (x16)

(Recommended operating condition unless otherwise noted, TA = 0 to 70°C)

| Parameter   | Symbol | Test Condition   | Version |     | Unit | NOTE |
|---|--------|--|---------|-----|------|------|
|   |        |  | 60      | 75  |      |      |
| Operating current<br>(One bank active)                                | ICC1   | Burst length = 1<br>$t_{RC} \geq t_{RC}(\min)$<br>IO = 0 mA  | 40      | 40  | mA   | 1    |
| Precharge standby current in<br>power-down mode                       | ICC2P  | $CKE \leq V_{IL}(\max)$ , $t_{CC} = 10\text{ns}$   | 2       | 2   | mA   |      |
|   | ICC2PS | $CKE \ \& \ CLK \leq V_{IL}(\max)$ , $t_{CC} = \infty$   | 2       | 2   |      |      |
| Precharge standby current in non<br>power-down mode                   | ICC2N  | $CKE \geq V_{IH}(\min)$ , $\overline{CS} \geq V_{IH}(\min)$ , $t_{CC} = 10\text{ns}$<br>Input signals are changed one time during 20ns | 15      | 15  | mA   |      |
|   | ICC2NS | $CKE \geq V_{IH}(\min)$ , $CLK \leq V_{IL}(\max)$ , $t_{CC} = \infty$<br>Input signals are stable                                      | 10      | 10  |      |      |
| Active standby current in power-<br>down mode                         | ICC3P  | $CKE \leq V_{IL}(\max)$ , $t_{CC} = 10\text{ns}$   | 5       | 5   | mA   |      |
|   | ICC3PS | $CKE \ \& \ CLK \leq V_{IL}(\max)$ , $t_{CC} = \infty$   | 5       | 5   |      |      |
| Active standby current in<br>non power-down mode<br>(One bank active) | ICC3N  | $CKE \geq V_{IH}(\min)$ , $\overline{CS} \geq V_{IH}(\min)$ , $t_{CC} = 10\text{ns}$<br>Input signals are changed one time during 20ns | 25      | 25  | mA   |      |
|   | ICC3NS | $CKE \geq V_{IH}(\min)$ , $CLK \leq V_{IL}(\max)$ , $t_{CC} = \infty$<br>Input signals are stable                                      | 20      | 20  | mA   |      |
| Operating current<br>(Burst mode)                                     | ICC4   | IO = 0 mA<br>Page burst<br>4Banks Activated<br>$t_{CCD} = 2CLKs$   | 60      | 60  | mA   | 1    |
| Refresh current   | ICC5   | $t_{RC} \geq t_{RC}(\min)$   | 100     | 100 | mA   | 2    |
| Self refresh current  | ICC6   | $CKE \leq 0.2V$  | C       | 2   | mA   | 3    |
|   |        |  | L       | 0.8 | 0.8  | mA   |

**NOTE :**

1. Measured with outputs open.
2. Refresh period is 64ms.
3. K4S281632O-LC
4. K4S281632O-LL
5. Unless otherwise noticed, input swing level is CMOS( $V_{IH}/V_{IL} = V_{DDQ}/V_{SSQ}$ ).

### 13. AC OPERATING TEST CONDITIONS

( $V_{DD} = 3.3V \pm 0.3V$ ,  $T_A = 0$  to  $70^\circ C$ )

| Parameter                                 | Value           | Unit |
|---|-----------------|------|
| Input levels ( $V_{ih}/V_{il}$ )          | 2.4/0.4         | V    |
| Input timing measurement reference level  | 1.4             | V    |
| Input rise and fall time                  | $t_r/t_f = 1/1$ | ns   |
| Output timing measurement reference level | 1.4             | V    |
| Output load condition                     | See Figure 3    |      |

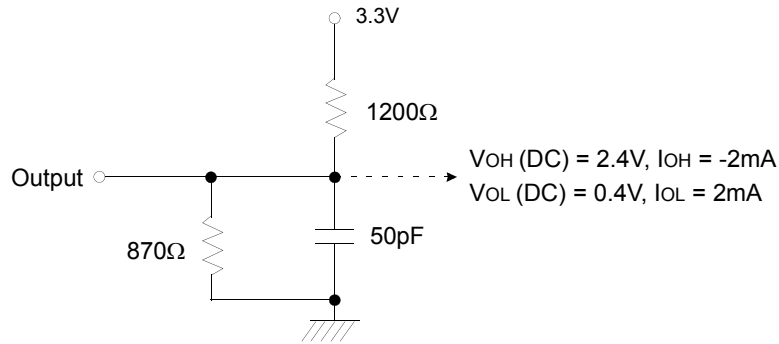

Figure 2. DC output load circuit

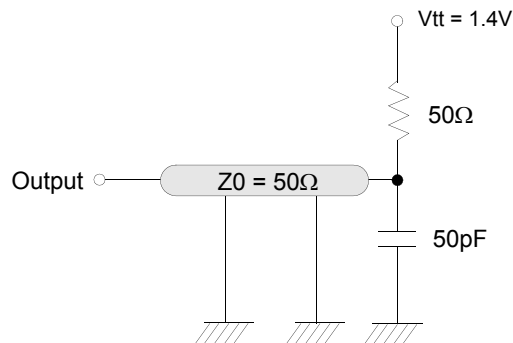

Figure 3. AC output load circuit

## 14. OPERATING AC PARAMETER

(AC operating conditions unless otherwise noted)

| Parameter                              | Symbol        | Version     |    | Unit |
|--|---------------|-------------|----|------|
|  |               | 60          | 75 |      |
| Row active to row active delay         | tRRD(min)     | 12          | 15 | ns   |
| RAS to CAS delay                       | tRCD(min)     | 18          | 20 | ns   |
| Row precharge time                     | tRP(min)      | 18          | 20 | ns   |
| Row active time                        | tRAS(min)     | 42          | 45 | ns   |
|  | tRAS(max)     | 100         |    | us   |
| Row cycle time                         | tRC(min)      | 60          | 65 | ns   |
| Last data in to row precharge          | tRDL(min)     | 2           |    | CLK  |
| Last data in to Active delay           | tDAL(min)     | 2 CLK + tRP |    | -    |
| Last data in to new col. address delay | tCDL(min)     | 1           |    | CLK  |
| Last data in to burst stop             | tBDL(min)     | 1           |    | CLK  |
| Col. address to col. address delay     | tCCD(min)     | 1           |    | CLK  |
| Number of valid output data            | CAS latency=3 | 2           |    | ea   |
|  | CAS latency=2 | -           | 1  |      |

**NOTE** : 1. The minimum number of clock cycles is determined by dividing the minimum time required with clock cycle time and then rounding off to the next higher integer.

2. Minimum delay is required to complete write.

3. All parts allow every cycle column address change.

4. In case of row precharge interrupt, auto precharge and read burst stop.

5. In 100MHz and below 100MHz operating conditions, tRDL=1CLK and tDAL=1CLK + 20ns is also supported. SAMSUNG recommends tRDL=2CLK and tDAL=2CLK + tRP.

6.  $t_{RC} = t_{RFC}$ ;  $t_{RDL} = t_{WR}$

## 15. AC CHARACTERISTICS

(AC operating conditions unless otherwise noted)

| Parameter                 |               | Symbol | 60  |      | 75  |      |
|---------------------------|---------------|--------|-----|------|-----|------|
|                           |               |        | Min | Max  | Min | Max  |
| CLK cycle time            | CAS latency=3 | tCC    | 6   | 1000 | 7.5 | 1000 |
|                           | CAS latency=2 |        | -   |      | 10  |      |
| CLK to valid output delay | CAS latency=3 | tSAC   |     | 5    |     | 5.4  |
|                           | CAS latency=2 |        |     | -    |     | 6    |
| Output data hold time     | CAS latency=3 | tOH    | 2.5 |      | 3   |      |
|                           | CAS latency=2 |        | -   |      | 3   |      |
| CLK high pulse width      |               | tCH    | 2.5 |      | 2.5 |      |
| CLK low pulse width       |               | tCL    | 2.5 |      | 2.5 |      |
| Input setup time          |               | tSS    | 1.5 |      | 1.5 |      |
| Input hold time           |               | tSH    | 1   |      | 0.8 |      |
| CLK to output in Low-Z    |               | tSLZ   | 1   |      | 1   |      |
| CLK to output in Hi-Z     | CAS latency=3 | tSHZ   |     | 5    |     | 5.4  |
|                           | CAS latency=2 |        |     | -    |     | 6    |

- NOTE** : 1. Parameters depend on programmed CAS latency.  
 2. If clock rising time is longer than 1ns,  $(tr/2-0.5)ns$  should be added to the parameter.  
 3. Assumed input rise and fall time ( $tr$  &  $tf$ ) = 1ns.  
 If  $tr$  &  $tf$  is longer than 1ns, transient time compensation should be considered, i.e.,  $[(tr + tf)/2-1]ns$  should be added to the parameter.  
 4. tSS applies for address setup time, clock enable setup time, command setup time and data setup time.  
 tSH applies for address setup time, clock enable setup time, command setup time and data setup time.

## 16. DQ BUFFER OUTPUT DRIVE CHARACTERISTICS

| Parameter        | Symbol | Condition                              | Min  | Typ | Max  | Unit     | NOTE |
|------------------|--------|--|------|-----|------|----------|------|
| Output rise time | trh    | Measure in linear region : 1.2V ~ 1.8V | 1.37 |     | 4.37 | Volts/ns | 3    |
| Output fall time | tfh    | Measure in linear region : 1.2V ~ 1.8V | 1.30 |     | 3.8  | Volts/ns | 3    |
| Output rise time | trh    | Measure in linear region : 1.2V ~ 1.8V | 2.8  | 3.9 | 5.6  | Volts/ns | 1,2  |
| Output fall time | tfh    | Measure in linear region : 1.2V ~ 1.8V | 2.0  | 2.9 | 5.0  | Volts/ns | 1,2  |

- NOTE** : 1. Rise time specification based on 0pF + 50 Ω to VSS, use these values to design to.  
 2. Fall time specification based on 0pF + 50 Ω to VDD, use these values to design to.  
 3. Measured into 50pF only, use these values to characterize to.  
 4. All measurements done with respect to VSS.

## 17. IBIS SPECIFICATION

[ Table 2 ] IOH Characteristics (Pull-up)

| Voltage<br>(V) | 200MHz<br>166MHz<br>133MHz<br>Min | 200MHz<br>166MHz<br>133MHz<br>Max |
|----------------|-----------------------------------|-----------------------------------|
|                | I (mA)                            | I (mA)                            |
| 3.45           |                                   | -2.4                              |
| 3.3            |                                   | -27.3                             |
| 3.0            | 0.0                               | -74.1                             |
| 2.6            | -21.1                             | -129.2                            |
| 2.4            | -34.1                             | -153.3                            |
| 2.0            | -58.7                             | -197.0                            |
| 1.8            | -67.3                             | -226.2                            |
| 1.65           | -73.0                             | -248.0                            |
| 1.5            | -77.9                             | -269.7                            |
| 1.4            | -80.8                             | -284.3                            |
| 1.0            | -88.6                             | -344.5                            |
| 0.0            | -93.0                             | -502.4                            |

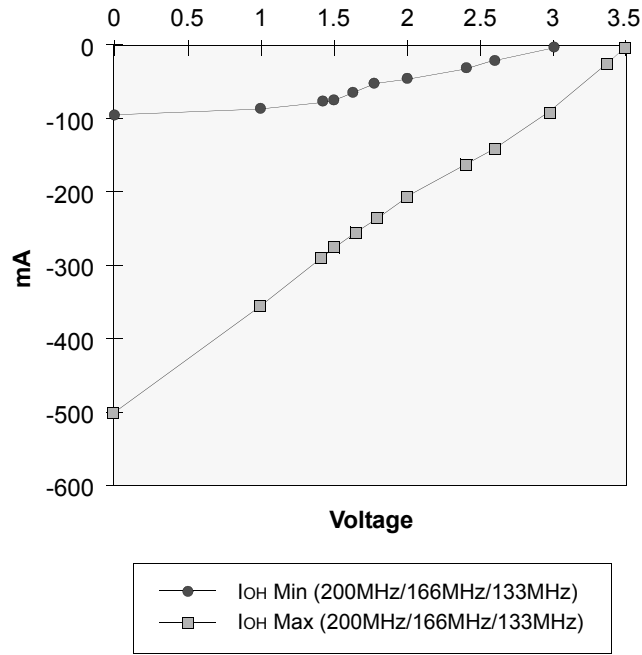

Figure 4. 200MHz/166MHz/133MHz Pull-up

[ Table 3 ] IOL Characteristics (Pull-down)

| Voltage<br>(V) | 200MHz<br>166MHz<br>133MHz<br>Min | 200MHz<br>166MHz<br>133MHz<br>Max |
|----------------|-----------------------------------|-----------------------------------|
|                | I (mA)                            | I (mA)                            |
| 0.0            | 0.0                               | 0.0                               |
| 0.4            | 27.5                              | 70.2                              |
| 0.65           | 41.8                              | 107.5                             |
| 0.85           | 51.6                              | 133.8                             |
| 1.0            | 58.0                              | 151.2                             |
| 1.4            | 70.7                              | 187.7                             |
| 1.5            | 72.9                              | 194.4                             |
| 1.65           | 75.4                              | 202.5                             |
| 1.8            | 77.0                              | 208.6                             |
| 1.95           | 77.6                              | 212.0                             |
| 3.0            | 80.3                              | 219.6                             |
| 3.45           | 81.4                              | 222.6                             |

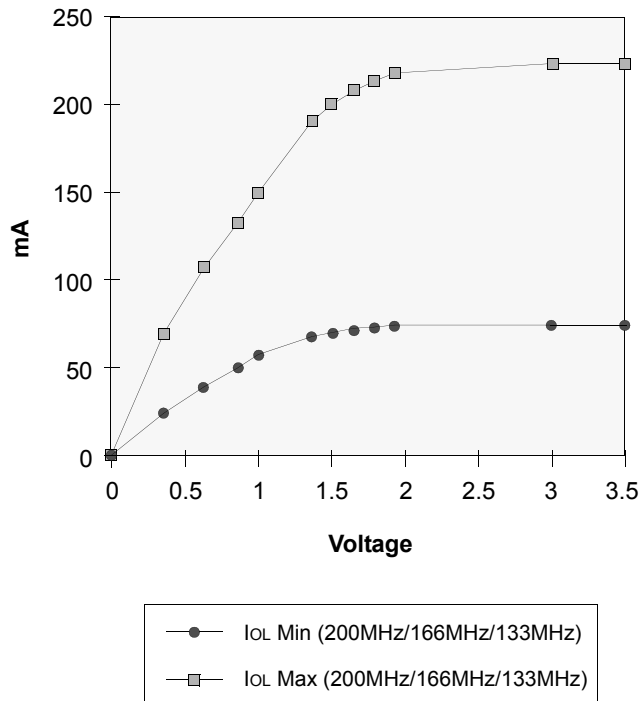

Figure 5. 200MHz/166MHz/133MHz Pull-down

[ Table 4 ]  $V_{DD}$  Clamp @ CLK, CKE,  $\overline{CS}$ , DQM & DQ

| $V_{DD}$ (V) | I (mA) |
|--------------|--------|
| 0.0          | 0.0    |
| 0.2          | 0.0    |
| 0.4          | 0.0    |
| 0.6          | 0.0    |
| 0.7          | 0.0    |
| 0.8          | 0.0    |
| 0.9          | 0.0    |
| 1.0          | 0.23   |
| 1.2          | 1.34   |
| 1.4          | 3.02   |
| 1.6          | 5.06   |
| 1.8          | 7.35   |
| 2.0          | 9.83   |
| 2.2          | 12.48  |
| 2.4          | 15.30  |
| 2.6          | 18.31  |

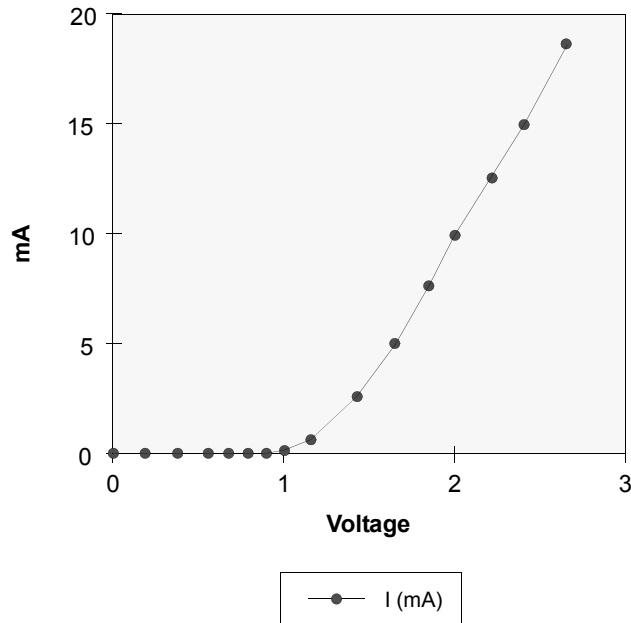

Figure 6. Minimum  $V_{DD}$  clamp current (Referenced to  $V_{DD}$ )



[ Table 5 ]  $V_{SS}$  Clamp @ CLK, CKE,  $\overline{CS}$ , DQM & DQ

| $V_{SS}$ (V) | I (mA) |
|--------------|--------|
| -2.6         | -57.23 |
| -2.4         | -45.77 |
| -2.2         | -38.26 |
| -2.0         | -31.22 |
| -1.8         | -24.58 |
| -1.6         | -18.37 |
| -1.4         | -12.56 |
| -1.2         | -7.57  |
| -1.0         | -3.37  |
| -0.9         | -1.75  |
| -0.8         | -0.58  |
| -0.7         | -0.05  |
| -0.6         | 0.0    |
| -0.4         | 0.0    |
| -0.2         | 0.0    |
| 0.0          | 0.0    |

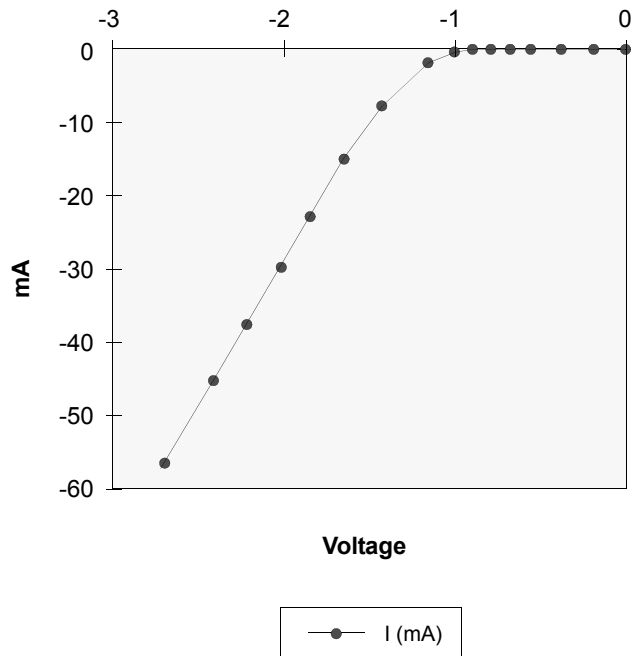

Figure 7. Minimum  $V_{SS}$  clamp current

## 18. SIMPLIFIED TRUTH TABLE

(V=Valid, X=Don't care, H=Logic high, L=Logic low)

| Command                            |                        | CKEn-1 | CKEn | $\overline{CS}$ | $\overline{RAS}$ | $\overline{CAS}$ | $\overline{WE}$ | DQM | BA0,1   | A10/AP      | A0 ~ A9, A11, | NOTE           |     |
|------------------------------------|------------------------|--------|------|-----------------|------------------|------------------|-----------------|-----|---------|-------------|---------------|----------------|-----|
| Register                           | Mode register set      | H      | X    | L               | L                | L                | L               | X   | OP code |             |               | 1,2            |     |
| Refresh                            | Auto refresh           |        | H    | H               | L                | L                | L               | H   | X       | X           |               | 3              |     |
|                                    | Self refresh           | Entry  |      | L               |                  |                  |                 |     |         |             |               | 3              |     |
|                                    |                        | Exit   | L    | H               | L                | H                | H               | H   | X       | X           | 3             |                |     |
|                                    | H                      |        | X    | X               | X                | 3                |                 |     |         |             |               |                |     |
| Bank active & row addr.            |                        | H      | X    | L               | L                | H                | H               | X   | V       | Row address |               |                |     |
| Read & column address              | Auto precharge disable |        | H    | X               | L                | H                | L               | H   | X       | V           | L             | Column address | 4   |
|                                    | Auto precharge enable  |        |      |                 |                  |                  |                 |     |         |             | H             |                | 4,5 |
| Write & column address             | Auto precharge disable |        | H    | X               | L                | H                | L               | L   | X       | V           | L             | Column address | 4   |
|                                    | Auto precharge enable  |        |      |                 |                  |                  |                 |     |         |             | H             |                | 4,5 |
| Burst stop                         |                        | H      | X    | L               | H                | H                | L               | X   | X       |             |               | 6              |     |
| Precharge                          | Bank selection         |        | H    | X               | L                | L                | H               | L   | X       | V           | L             | X              |     |
|                                    | All banks              |        |      |                 |                  |                  |                 |     |         | X           | H             |                |     |
| Clock suspend or active power down | Entry                  |        | H    | L               | H                | X                | X               | X   | X       |             | X             |                |     |
|                                    | Exit                   |        |      |                 | L                | H                | X               | X   |         |             |               | X              | X   |
| Precharge power down mode          | Entry                  |        | H    | L               | H                | X                | X               | X   | X       |             | X             |                |     |
|                                    |                        |        |      |                 | L                | H                | H               | H   |         |             |               |                |     |
|                                    | Exit                   |        | L    | H               | H                | X                | X               | X   | X       |             | X             |                |     |
|                                    |                        |        |      |                 | L                | V                | V               | V   |         |             |               |                |     |
| DQM                                |                        | H      | X    |                 |                  |                  | V               | X   |         |             | 7             |                |     |
| No operation command               |                        | H      | X    | H               | X                | X                | X               | X   |         | X           |               |                |     |
|                                    |                        |        |      | L               | H                | H                | H               |     |         |             |               |                |     |

**NOTE :**

- OP Code : Operand code  
A0 ~ A11 & BA0 ~ BA1 : Program keys. (@ MRS)
- MRS can be issued only at all banks precharge state.  
A new command can be issued after 2 CLK cycles of MRS.
- Auto refresh functions are as same as CBR refresh of DRAM.  
The automatical precharge without row precharge command is meant by "Auto".  
Auto/self refresh can be issued only at all banks precharge state.
- BA0 ~ BA1 : Bank select addresses.  
If both BA0 and BA1 are "Low" at read, write, row active and precharge, bank A is selected.  
If BA0 is "High" and BA1 is "Low" at read, write, row active and precharge, bank B is selected.  
If BA0 is "Low" and BA1 is "High" at read, write, row active and precharge, bank C is selected.  
If both BA0 and BA1 are "High" at read, write, row active and precharge, bank D is selected.  
If A10/AP is "High" at row precharge, BA0 and BA1 is ignored and all banks are selected.
- During burst read or write with auto precharge, new read/write command can not be issued.  
Another bank read/write command can be issued after the end of burst.  
New row active of the associated bank can be issued at tRP after the end of burst.
- Burst stop command is valid at every burst length.
- DQM sampled at positive going edge of a CLK and masks the data-in at the very CLK (Write DQM latency is 0), but makes Hi-Z state the data-out of 2 CLK cycles after. (Read DQM latency is 2)