

K4X51323PC - 7(8)E/G

Preliminary
Mobile-DDR SDRAM

www.DataSheet4U.com

16M x32
Mobile-DDR SDRAM



Document Title**16M x32 Mobile-DDR SDRAM****Revision History**

<u>Revision No.</u>	<u>History</u>	<u>Draft Date</u>	<u>Remark</u>
0.0	- First version for target specification	October 27. 2004	Target
0.1	- Insertion of PKG dimension of 90FBGA JEDEC Standard type.	December 13. 2004	Target
0.2	- Preliminary Datasheet - Insertion DC Current value.	December 20. 2004	Preliminary
0.3	- Changing Frequency from DDR333/DDR266 to DDR266/DDR222. - Updating DC current value. - Changing expression of PKG dimension.	February 15. 2005	Preliminary
0.4	- Changing format with JEDEC standard type.	February 18. 2005	Preliminary
0.5	- Insertion of Normal power bin. - Changing IDD3P/3PS - Changing IDD6 limit.	September 07. 2005	Preliminary
0.6	- Define maximum burst refresh cycle. - Add a note related with Vdd & Vddq. - Add a note related with IDD8.	October 18. 2005	Preliminary

www.DataSheet4U.com

K4X51323PC - 7(8)E/G

Mobile-DDR SDRAM

16M x32 Mobile-DDR SDRAM

FEATURES

- 1.8V power supply, 1.8V I/O power
- Double-data-rate architecture; two data transfers per clock cycle
- Bidirectional data strobe(DQS)
- Four banks operation
- 1 /CS
- 1 CKE
- Differential clock inputs(CK and \overline{CK})
- MRS cycle with address key programs
 - CAS Latency (2, 3)
 - Burst Length (2, 4, 8, 16)
 - Burst Type (Sequential & Interleave)
 - Partial Self Refresh Type (Full, 1/2, 1/4 Array)
 - Output Driver Strength Control (Full, 1/2, 1/4, 1/8)
- Internal Temperature Compensated Self Refresh
- Deep Power Down Mode
- All inputs except data & DM are sampled at the positive going edge of the system clock(CK).
- Data I/O transactions on both edges of data strobe, DM for masking.
- Edge aligned data output, center aligned data input.
- No DLL; CK to DQS is not synchronized.
- DM0 - DM3 for write masking only.
- Auto refresh duty cycle
 - 7.8us for -25 to 85 °C

www.DataSheet4U.com

Operating Frequency

	DDR266	DDR222
Speed @CL2 ¹	83Mhz	66Mhz
Speed @CL3 ¹	133Mhz	111Mhz

Note :

1. CAS Latency

Address configuration

Organization	Bank	Row	Column
16M x32	BA0,BA1	A0 - A12	A0 - A8

- DM is internally loaded to match DQ and DQS identically.

Ordering Information

Part No.	Max Freq.	Interface	Package
K4X51323PC-7(8)E/GC3	133MHz(CL=3),83MHz(CL=2)	LVCMOS	90FBGA Pb (Pb Free)
K4X51323PC-7(8)E/GCA	111MHz(CL=3),66MHz(CL=2)		

- 7(8)E : 90FBGA Pb(Pb Free), Normal Power, Extended Temperature(-25 °C ~ 85 °C)

- 7(8)G : 90FBGA Pb(Pb Free), Low Power, Extended Temperature(-25 °C ~ 85 °C)

- C3/CA : 133MHz(CL=3) / 111MHz(CL=3)

INFORMATION IN THIS DOCUMENT IS PROVIDED IN RELATION TO SAMSUNG PRODUCTS, AND IS SUBJECT TO CHANGE WITHOUT NOTICE. NOTHING IN THIS DOCUMENT SHALL BE CONSTRUED AS GRANTING ANY LICENSE, EXPRESS OR IMPLIED, BY ESTOPPEL OR OTHERWISE, TO ANY INTELLECTUAL PROPERTY RIGHTS IN SAMSUNG PRODUCTS OR TECHNOLOGY. ALL INFORMATION IN THIS DOCUMENT IS PROVIDED ON AS "AS IS" BASIS WITHOUT GUARANTEE OR WARRANTY OF ANY KIND.

1. For updates or additional information about Samsung products, contact your nearest Samsung office.

2. Samsung products are not intended for use in life support, critical care, medical, safety equipment, or similar applications where Product failure could result in loss of life or personal or physical harm, or any military or defense application, or any governmental procurement to which special terms or provisions may apply.



K4X51323PC - 7(8)E/G

Preliminary
Mobile-DDR SDRAM

FUNCTIONAL BLOCK DIAGRAM

www.DataSheet4U.com

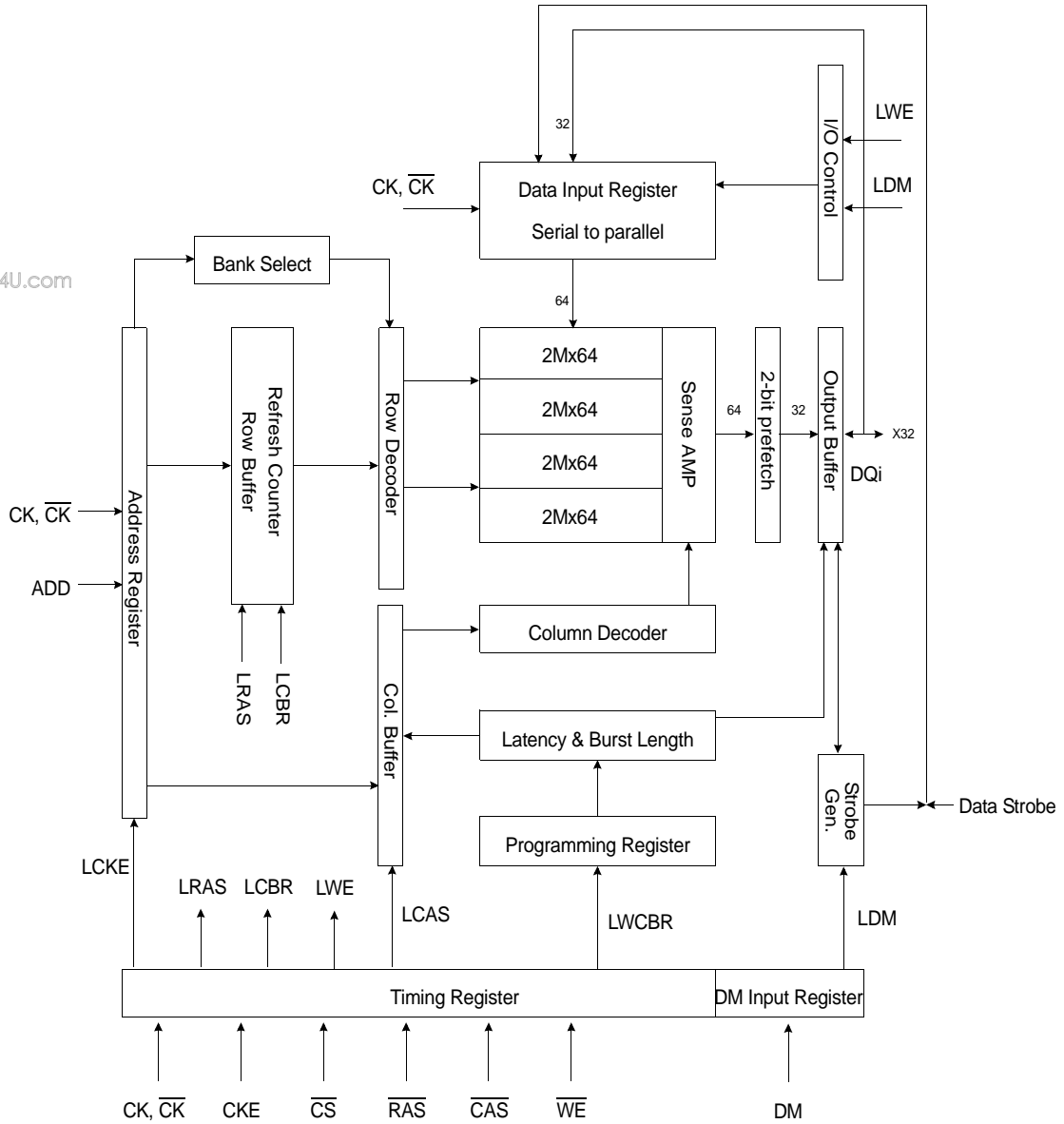

K4X51323PC - 7(8)E/G

Preliminary Mobile-DDR SDRAM

Package Dimension and Pin Configuration

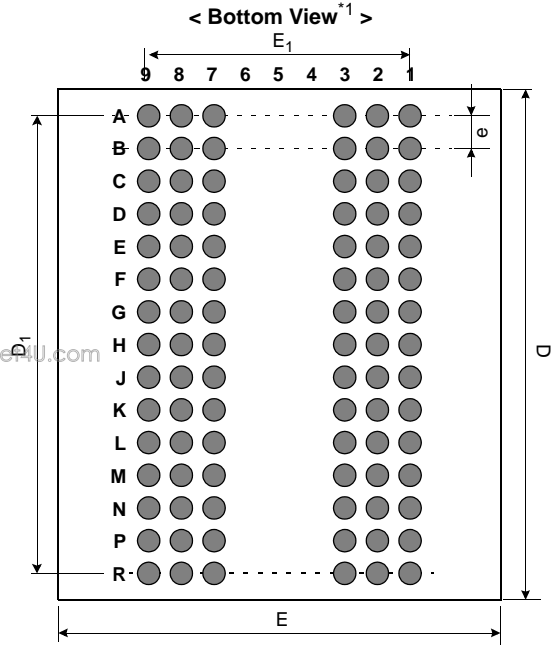

www.DataSheet4U.com

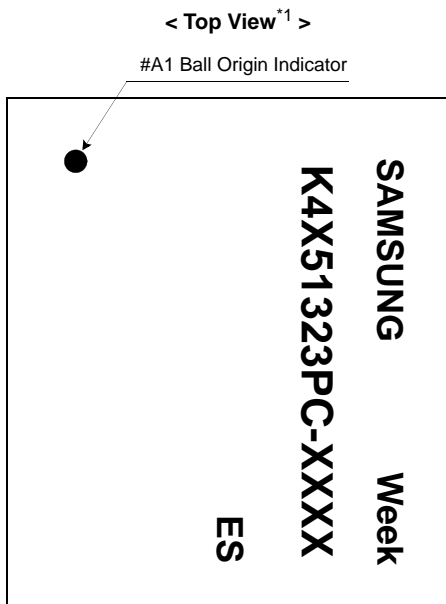
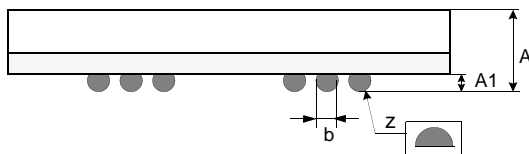

< Top View *2 >

90Ball(6x15) FBGA						
	1	2	3	7	8	9
A	Vss	DQ31	Vssq	VDDQ	DQ16	VDD
B	VDDQ	DQ29	DQ30	DQ17	DQ18	Vssq
C	Vssq	DQ27	DQ28	DQ19	DQ20	VDDQ
D	VDDQ	DQ25	DQ26	DQ21	DQ22	Vssq
E	Vssq	DQS3	DQ24	DQ23	DQS2	VDDQ
F	VDD	DM3	NC	NC	DM2	Vss
G	CKE	CK	\overline{CK}	\overline{WE}	\overline{CAS}	\overline{RAS}
H	A9	A11	A12	\overline{CS}	BA0	BA1
J	A6	A7	A8	A10	A0	A1
K	A4	DM1	A5	A2	DM0	A3
L	Vssq	DQS1	DQ8	DQ7	DQS0	VDDQ
M	VDDQ	DQ9	DQ10	DQ5	DQ6	Vssq
N	Vssq	DQ11	DQ12	DQ3	DQ4	VDDQ
P	VDDQ	DQ13	DQ14	DQ1	DQ2	Vssq
R	Vss	DQ15	Vssq	VDDQ	DQ0	VDD

Ball Name	Ball Function
CK, \overline{CK}	System Differential Clock
\overline{CS}	Chip Select
CKE	Clock Enable
A0 ~ A12	Address
BA0 ~ BA1	Bank Select Address
\overline{RAS}	Row Address Strobe
\overline{CAS}	Column Address Strobe
\overline{WE}	Write Enable
DM0~3	Data Input Mask
DQS0~3	Data Strobe
DQ0 ~ 31	Data Input/Output
VDD/Vss	Power Supply/Ground
VDDQ/Vssq	Data Output Power/Ground

[Unit: mm]

Symbol	Min	Typ	Max
A	-	-	1.00
A ₁	0.25	-	-
E	10.9	11.0	11.1
E ₁	-	6.40	-
D	13.2	13.0	13.1
D ₁	-	11.2	-
e	-	0.80	-
b	0.45	0.50	0.55
z	-	-	0.10

Input/Output Function Description

SYMBOL	TYPE	DESCRIPTION
CK, \overline{CK}	Input	Clock : CK and \overline{CK} are differential clock inputs. All address and control input signals are sampled on the crossing of the positive edge of CK and negative edge of \overline{CK} . Internal clock signals are derived from CK/ \overline{CK} .
CKE	Input	Clock Enable : CKE HIGH activates, and CKE LOW deactivates internal clock signals, and device input buffers and output drivers. Taking CKE LOW provides PRECHARGE POWER-DOWN and SELF REFRESH operation (all banks idle), or ACTIVE POWER-DOWN (row ACTIVE in any banks). CKE is synchronous for all functions except for disabling outputs, which is achieved asynchronously. Input buffers, excluding CK, \overline{CK} and CKE, are disabled during power-down and self refresh mode which are contrived for low standby power consumption.
\overline{CS}	Input	Chip Select : \overline{CS} enables (registered LOW) and disables (registered HIGH) the command decoder. All commands are masked when \overline{CS} is registered HIGH. \overline{CS} provides for external bank selection on systems with multiple banks. \overline{CS} is considered part of the command code.
\overline{RAS} , \overline{CAS} , \overline{WE}	Input	Command Inputs : \overline{RAS} , \overline{CAS} and \overline{WE} (along with \overline{CS}) define the command being entered.
DM0,DM1, DM2,DM3	Input	Input Data Mask : DM is an input mask signal for write data. Input data is masked when DM is sampled HIGH along with that input data during a WRITE access. DM is sampled on both edges of DQS. DM pins include dummy loading internally, to match the DQ and DQS loading. For the x32, DM0 corresponds to the data on DQ0-DQ7 ; DM1 corresponds to the data on DQ8-DQ15, DM2 corresponds to the data on DQ16-DQ23, DM3 corresponds to the data on DQ24-DQ31
BA0, BA1	Input	Bank Address Inputs : BA0 and BA1 define to which bank an ACTIVE, READ, WRITE or PRECHARGE command is being applied.
A [n : 0]	Input	Address Inputs : Provide the row address for ACTIVE commands, and the column address and AUTO PRECHARGE bit for READ/WRITE commands, to select one location out of the memory array in the respective bank. A10 sampled during a PRECHARGE command determines whether the PRECHARGE applies to one bank (A10 LOW) or all banks (A10 HIGH). If only one bank is to be precharged, the bank is selected by BA0, BA1. The address inputs also provide the op-code during a MODE REGISTER SET command. BA0 and BA1 determines which mode register (mode register or extended mode register) is loaded during the MODE REGISTER SET command.
DQ	I/O	Data Input/Output : Data bus
DQS0,DQS1, DQS2,DQS3	I/O	Data Strobe : Output with read data, input with write data. Edge-aligned with read data, centered in write data. it is used to fetch write data. For the x32, DQS0 corresponds to the data on DQ0-DQ7 ; DQS1 corresponds to the data on DQ8-DQ15,DQS2 corresponds to the data on DQ16-DQ23, DQS3 corresponds to the data on DQ24-DQ31
NC	-	No Connect : No internal electrical connection is present.
VDDQ	Supply	DQ Power Supply : 1.7V to 1.95V
VSSQ	Supply	DQ Ground.
VDD	Supply	Power Supply : 1.7V to 1.95V
VSS	Supply	Ground.

www.DataSheet4U.com

Functional Description

www.DataSheet4U.com

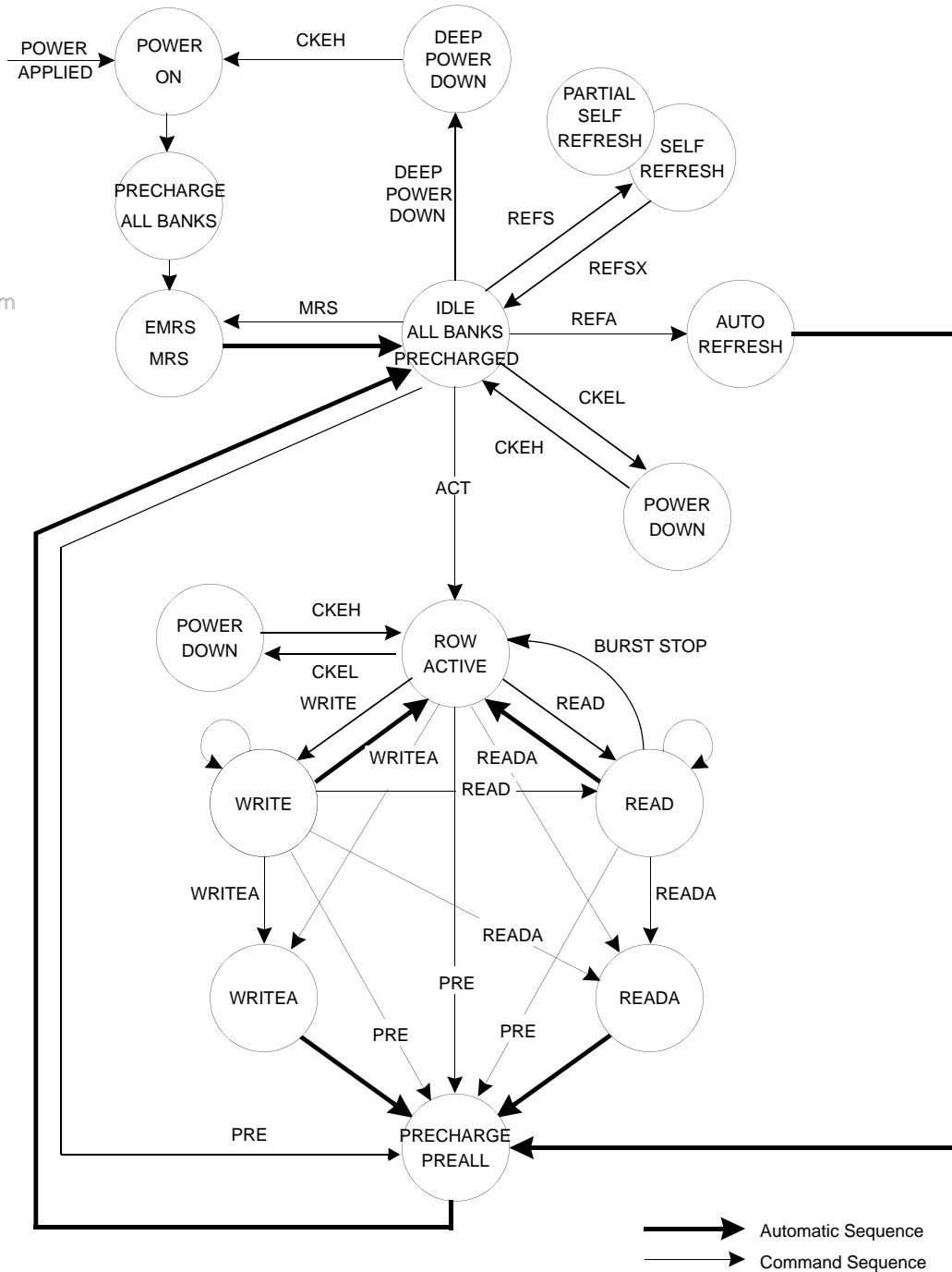

Figure.1 State diagram

Mode Register Definition

Mode Register Set(MRS)

The mode register is designed to support the various operating modes of DDR SDRAM. It includes Cas latency, addressing mode, burst length, test mode and vendor specific options to make DDR SDRAM useful for variety of applications. The default value of the mode register is not defined, therefore the mode register must be written in the power up sequence of DDR SDRAM. The mode register is written by asserting low on CS, RAS, CAS and WE(The DDR SDRAM should be in active mode with CKE already high prior to writing into the mode register). The states of address pins A0 ~ A12 and BA0, BA1 in the same cycle as CS, RAS, CAS and WE going low are written in the mode register. Two clock cycles are required to complete the write operation in the mode register. Even if the power-up sequence is finished and some read or write operation is executed afterward, the mode register contents can be changed with the same command and two clock cycles. This command must be issued only when all banks are in the idle state. If mode register is changed, extended mode register automatically is reset and come into default state. So extended mode register must be set again. The mode register is divided into various fields depending on functionality. The burst length uses A0 ~ A2, addressing mode uses A3, Cas latency(read latency from column address) uses A4 ~ A6, A7 ~ A12 is used for test mode. BA0 and BA1 must be set to low for proper MRS operation.

www.DataSheet4U.com

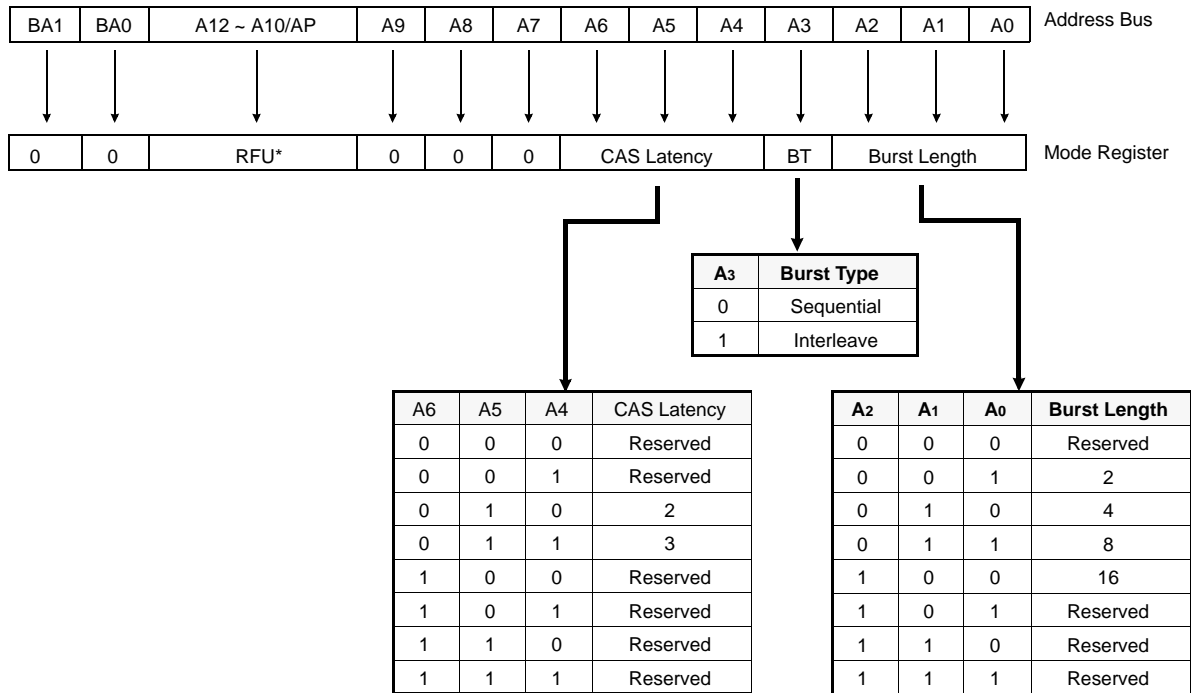

Figure.2 Mode Register Set

Note :
RFU(Reserved for future use) should stay "0" during MRS cycle

Burst address ordering for burst length

Burst Length	Starting Address (A3, A2, A1, A0)	Sequential Mode	Interleave Mode
2	xxx0	0, 1	0, 1
	xxx1	1, 0	1, 0
4	xx00	0, 1, 2, 3	0, 1, 2, 3
	xx01	1, 2, 3, 0	1, 0, 3, 2
	xx10	2, 3, 0, 1	2, 3, 0, 1
	xx11	3, 0, 1, 2	3, 2, 1, 0
8	x000	0, 1, 2, 3, 4, 5, 6, 7	0, 1, 2, 3, 4, 5, 6, 7
	x001	1, 2, 3, 4, 5, 6, 7, 0	1, 0, 3, 2, 5, 4, 7, 6
	x010	2, 3, 4, 5, 6, 7, 0, 1	2, 3, 0, 1, 6, 7, 4, 5
	x011	3, 4, 5, 6, 7, 0, 1, 2	3, 2, 1, 0, 7, 6, 5, 4
	x100	4, 5, 6, 7, 0, 1, 2, 3	4, 5, 6, 7, 0, 1, 2, 3
	x101	5, 6, 7, 0, 1, 2, 3, 4	5, 4, 7, 6, 1, 0, 3, 2
	x110	6, 7, 0, 1, 2, 3, 4, 5	6, 7, 4, 5, 2, 3, 0, 1
	x111	7, 0, 1, 2, 3, 4, 5, 6	7, 6, 5, 4, 3, 2, 1, 0
16	0000	0, 1, 2, 3, 4, 5, 6, 7, 8, 9, 10, 11, 12, 13, 14, 15	0, 1, 2, 3, 4, 5, 6, 7, 8, 9, 10, 11, 12, 13, 14, 15
	0001	1, 2, 3, 4, 5, 6, 7, 8, 9, 10, 11, 12, 13, 14, 15, 0	1, 0, 3, 2, 5, 4, 7, 6, 9, 8, 11, 10, 13, 12, 15, 14
	0010	2, 3, 4, 5, 6, 7, 8, 9, 10, 11, 12, 13, 14, 15, 0, 1	2, 3, 0, 1, 6, 7, 4, 5, 10, 11, 8, 9, 14, 15, 12, 13
	0011	3, 4, 5, 6, 7, 8, 9, 10, 11, 12, 13, 14, 15, 0, 1, 2	3, 2, 1, 0, 7, 6, 5, 4, 11, 10, 9, 8, 15, 14, 13, 12
	0100	4, 5, 6, 7, 8, 9, 10, 11, 12, 13, 14, 15, 0, 1, 2, 3	4, 5, 6, 7, 0, 1, 2, 3, 12, 13, 14, 15, 8, 9, 10, 11
	0101	5, 6, 7, 8, 9, 10, 11, 12, 13, 14, 15, 0, 1, 2, 3, 4	5, 4, 7, 6, 1, 0, 3, 2, 13, 12, 15, 14, 9, 8, 11, 10
	0110	6, 7, 8, 9, 10, 11, 12, 13, 14, 15, 0, 1, 2, 3, 4, 5	6, 7, 4, 5, 2, 3, 0, 1, 14, 15, 12, 13, 10, 11, 8, 9
	0111	7, 8, 9, 10, 11, 12, 13, 14, 15, 0, 1, 2, 3, 4, 5, 6	7, 6, 5, 4, 3, 2, 1, 0, 15, 14, 13, 12, 11, 10, 9, 8
	1000	8, 9, 10, 11, 12, 13, 14, 15, 0, 1, 2, 3, 4, 5, 6, 7	8, 9, 10, 11, 12, 13, 14, 15, 0, 1, 2, 3, 4, 5, 6, 7
	1001	9, 10, 11, 12, 13, 14, 15, 0, 1, 2, 3, 4, 5, 6, 7, 8	9, 8, 11, 10, 13, 12, 15, 14, 1, 0, 3, 2, 5, 4, 7, 6
	1010	10, 11, 12, 13, 14, 15, 0, 1, 2, 3, 4, 5, 6, 7, 8, 9	10, 11, 8, 9, 14, 15, 12, 13, 2, 3, 0, 1, 6, 7, 4, 5
	1011	11, 12, 13, 14, 15, 0, 1, 2, 3, 4, 5, 6, 7, 8, 9, 10	11, 10, 9, 8, 15, 14, 13, 12, 3, 2, 1, 0, 7, 6, 5, 4
	1100	12, 13, 14, 15, 0, 1, 2, 3, 4, 5, 6, 7, 8, 9, 10, 11	12, 13, 14, 15, 8, 9, 10, 11, 4, 5, 6, 7, 0, 1, 2, 3
	1101	13, 14, 15, 0, 1, 2, 3, 4, 5, 6, 7, 8, 9, 10, 11, 12	13, 12, 15, 14, 9, 8, 11, 10, 5, 4, 7, 6, 1, 0, 3, 2
	1110	14, 15, 0, 1, 2, 3, 4, 5, 6, 7, 8, 9, 10, 11, 12, 13	14, 15, 12, 13, 10, 11, 8, 9, 6, 7, 4, 5, 2, 3, 0, 1
	1111	15, 0, 1, 2, 3, 4, 5, 6, 7, 8, 9, 10, 11, 12, 13, 14	15, 14, 13, 12, 11, 10, 9, 8, 7, 6, 5, 4, 3, 2, 1, 0

www.DataSheet4U.com

Extended Mode Register Set(EMRS)

The extended mode register is designed to support partial array self refresh or driver strength control. EMRS cycle is not mandatory and the EMRS command needs to be issued only when either PASR or DS is used. The default state without EMRS command issued is half driver strength, and Full array refreshed. The extended mode register is written by asserting low on CS, RAS, CAS, WE and high on BA1, low on BA0(The DDR SDRAM should be in all bank precharge with CKE already high prior to writing into the extended mode register). The state of address pins A0 ~ A12 in the same cycle as CS, RAS, CAS and WE going low is written in the extended mode register. Two clock cycles are required to complete the write operation in the extended mode register. Even if the power-up sequence is finished and some read or write operations is executed afterward, the mode register contents can be changed with the same command and two clock cycles. But this command must be issued only when all banks are in the idle state. A0 - A2 are used for partial array self refresh and A5 - A6 are used for driver strength control. "High" on BA1 and "Low" on BA0 are used for EMRS. All the other address pins except A0,A1,A2,A5,A6, BA1, BA0 must be set to low for proper EMRS operation. Refer to the table for specific codes.

www.DataSheet4U.com

Extended MRS for PASR(Partial Array Self Refresh) & DS(Driver Strength Control)

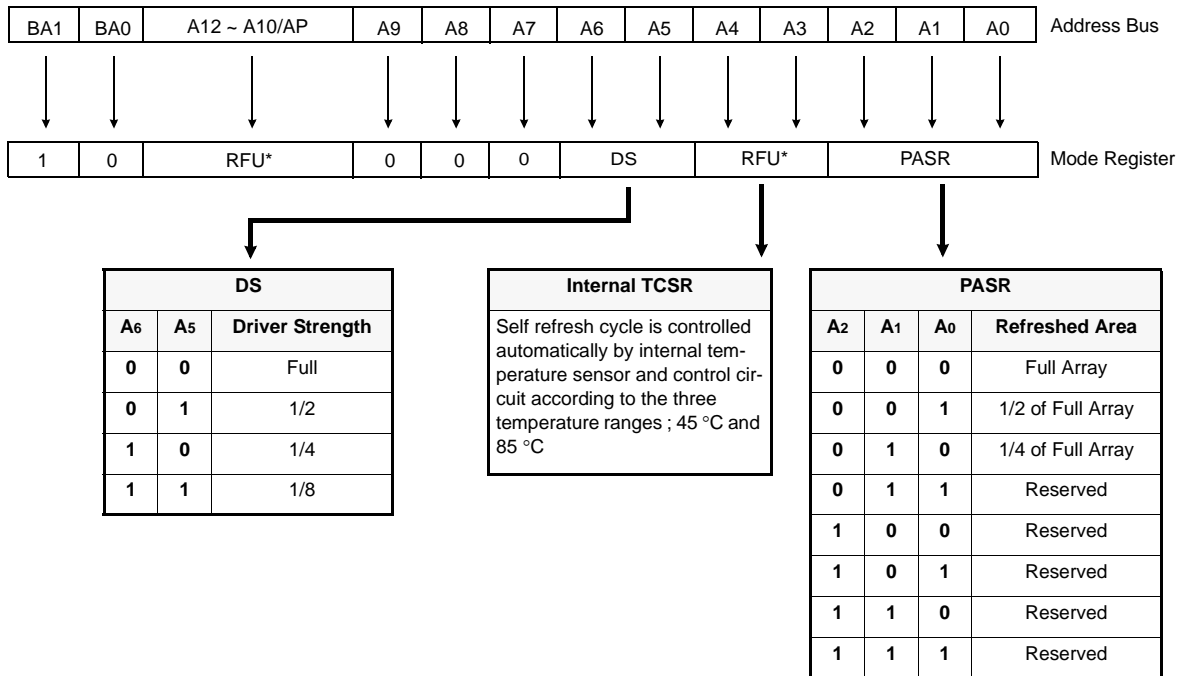

Figure.3 Extended Mode Register Set

Note :
RFU(Reserved for future use) should stay "0" during EMRS cycle

Internal Temperature Compensated Self Refresh (TCSR)

Note :

1. In order to save power consumption, Mobile DDR SDRAM includes the internal temperature sensor and control units to control the self refresh cycle automatically according to the three temperature ranges ; 45 °C and 85 °C.
2. If the EMRS for external TCSR is issued by the controller, this EMRS code for TCSR is ignored.
3. It has +/- 5 °C tolerance.

Temperature Range	Self Refresh Current (IDD6)						Unit
	- E			- G			
	Full Array	1/2 Array	1/4 Array	Full Array	1/2 Array	1/4 Array	
45 °C ³	300	270	255	250	220	205	uA
85 °C	600	500	450	500	400	350	

www.DataSheet4U.com

Partial Array Self Refresh (PASR)

Note :

1. In order to save power consumption, Mobile-DDR SDRAM includes PASR option.
2. Mobile-DDR SDRAM supports three kinds of PASR in self refresh mode; Full array, 1/2 Array, 1/4 Array.

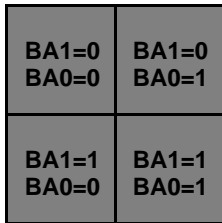

- Full Array

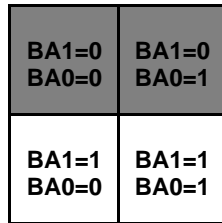

- 1/2 Array

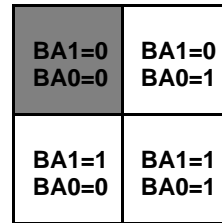

- 1/4 Array



Partial Self Refresh Area

Figure.4 EMRS code and TCSR , PASR

Absolute maximum ratings

Parameter	Symbol	Value	Unit
Voltage on any pin relative to V _{SS}	V _{IN} , V _{OUT}	-0.5 ~ 2.7	V
Voltage on V _{DD} supply relative to V _{SS}	V _{DD}	-0.5 ~ 2.7	V
Voltage on V _{DDQ} supply relative to V _{SS}	V _{DDQ}	-0.5 ~ 2.7	V
Storage temperature	T _{STG}	-55 ~ +150	°C
Power dissipation	P _D	1.0	W
Short circuit current	I _{OS}	50	mA

www.DataSheet4U.com

Note:
Permanent device damage may occur if ABSOLUTE MAXIMUM RATINGS are exceeded.
Functional operation should be restricted to recommend operation condition.
Exposure to higher than recommended voltage for extended periods of time could affect device reliability.

DC Operating Conditions

Recommended operating conditions(Voltage referenced to VSS=0V, Tc = -25°C to 85°C)

Parameter	Symbol	Min	Max	Unit	Note
Supply voltage(for device with a nominal VDD of 1.8V)	VDD	1.7	1.95	V	1
I/O Supply voltage	VDDQ	1.7	1.95	V	1
Input logic high voltage	VIH(DC)	0.7 x VDDQ	VDDQ+0.3	V	2
Input logic low voltage	VIL(DC)	-0.3	0.3 x VDDQ	V	2
Output logic high voltage	VOH(DC)	0.9 x VDDQ	-	V	IOH = -0.1mA
Output logic low voltage	VOL(DC)	-	0.1 x VDDQ	V	IOL = 0.1mA
Input leakage current	II	-2	2	uA	
Output leakage current	IOZ	-5	5	uA	

Note :
1. Under all conditions, VDDQ must be less than or equal to VDD.
2. These parameters should be tested at the pin on actual components and may be checked at either the pin or the pad in simulation.

DC CHARACTERISTICS

Recommended operating conditions (Voltage referenced to V_{SS} = 0V, T_c = -25 to 85°C)

Parameter	Symbol	Test Condition	DDR266	DDR222	Unit		
Operating Current (One Bank Active)	IDD0	t _{RC} = t _{RCmin} ; t _{CK} = t _{CKmin} ; CKE is HIGH; CS is HIGH between valid commands; address inputs are SWITCHING; data bus inputs are STABLE	80	70	mA		
Precharge Standby Current in power-down mode	IDD2P	all banks idle, CKE is LOW; CS is HIGH, t _{CK} = t _{CKmin} ; address and control inputs are SWITCHING; data bus inputs are STABLE	0.3		mA		
	IDD2PS	all banks idle, CKE is LOW; \overline{CS} is HIGH, CK = LOW, \overline{CK} = HIGH; address and control inputs are SWITCHING; data bus inputs are STABLE	0.3				
Precharge Standby Current in non power-down mode	IDD2N	all banks idle, CKE is HIGH; \overline{CS} is HIGH, t _{CK} = t _{CKmin} ;address and control inputs are SWITCHING; data bus inputs are STABLE	12	10	mA		
	IDD2NS	all banks idle, CKE is HIGH; \overline{CS} is HIGH, CK = LOW, \overline{CK} = HIGH; address and control inputs are SWITCHING; data bus inputs are STABLE	8	7			
Active Standby Current in power-down mode	IDD3P	one bank active, CKE is LOW; \overline{CS} is HIGH, t _{CK} = t _{CKmin} ;address and control inputs are SWITCHING; data bus inputs are STABLE	6		mA		
	IDD3PS	one bank active, CKE is LOW; \overline{CS} is HIGH, CK = LOW, \overline{CK} = HIGH;address and control inputs are SWITCHING; data bus inputs are STABLE	3				
Active Standby Current in non power-down mode (One Bank Active)	IDD3N	one bank active, CKE is HIGH; \overline{CS} is HIGH, t _{CK} = t _{CKmin} ;address and control inputs are SWITCHING; data bus inputs are STABLE	25	20	mA		
	IDD3NS	one bank active, CKE is HIGH; \overline{CS} is HIGH, CK = LOW, \overline{CK} = HIGH; address and control inputs are SWITCHING; data bus inputs are STABLE	20	15			
Operating Current (Burst Mode)	IDD4R	one bank active; BL = 4; CL = 3; t _{CK} = t _{CKmin} ; continuous read bursts; I _{OUT} = 0 mA address inputs are SWITCHING; 50% data change each burst transfer	125	105	mA		
	IDD4W	one bank active; BL = 4; t _{CK} = t _{CKmin} ; continuous write bursts;address inputs are SWITCHING; 50% data change each burst transfer	100	90			
Refresh Current	IDD5	t _{RC} = t _{RFCmin} ; t _{CK} = t _{CKmin} ; burst refresh; CKE is HIGH;address and control inputs are SWITCHING; data bus inputs are STABLE	150	135	mA		
Self Refresh Current	IDD6	CKE is LOW; t _{CK} = t _{CKmin} ; Extended Mode Register set to all 0's; address and control inputs are STABLE; data bus inputs are STABLE	TCSR		°C		
			-E	Full		300	600
				1/2		270	500
				1/4		255	450
			-G	Full		250	500
				1/2		220	400
1/4	205	350					
Deep Power Down Current	IDD8 ^{*2}	Address and control inputs are STABLE; data bus inputs are STABLE	10		uA		

Note :

- It has +/- 5°C tolerance.
- DPD(Deep Power Down) function is an optional feature, and it will be enabled upon request.
Please contact Samsung for more information.
- IDD specifications are tested after the device is properly initialized.
- Input slew rate is 1V/ns.
- Definitions for IDD: LOW is defined as V_{IN} ≤ 0.1 * VDDQ ;
HIGH is defined as V_{IN} ≥ 0.9 * VDDQ ;
STABLE is defined as inputs stable at a HIGH or LOW level ;
SWITCHING is defined as: - address and command: inputs changing between HIGH and LOW once per two clock cycles ;
- data bus inputs: DQ changing between HIGH and LOW once per clock cycle; DM and DQS are STABLE.



AC Operating Conditions & Timing Specification

Parameter/Condition	Symbol	Min	Max	Unit	Note
Input High (Logic 1) Voltage, all inputs	V _{IH} (AC)	0.8 x V _{DDQ}	V _{DDQ} +0.3	V	1
Input Low (Logic 0) Voltage, all inputs	V _{IL} (AC)	-0.3	0.2 x V _{DDQ}	V	1
Input Crossing Point Voltage, CK and $\overline{\text{CK}}$ inputs	V _{IX} (AC)	0.4 x V _{DDQ}	0.6 x V _{DDQ}	V	2

Note :

1. These parameters should be tested at the pin on actual components and may be checked at either the pin or the pad in simulation.
2. The value of V_{IX} is expected to equal 0.5*V_{DDQ} of the transmitting device and must track variations in the DC level of the same.

AC Timing Parameters & Specifications

Parameter	Symbol	DDR266		DDR222		Unit	Note
		Min	Max	Min	Max		
Clock cycle time	CL=2	tCK	12.0		15.0		ns
	CL=3		7.5		9.0		
Row cycle time	tRC	67.5		81		ns	
Row active time	tRAS	45	70,000	54	70,000	ns	
RAS to CAS delay	tRCD	22.5		27		ns	
Row precharge time	tRP	22.5		27		ns	
Row active to Row active delay	tRRD	15		15		ns	
Write recovery time	tWR	15		15		ns	
Last data in to Active delay	tDAL	2tCK+tRP		2tCK+tRP		-	2
Last data in to Read command	tCDLR	1		1		tCK	
Col. address to Col. address delay	tCCD	1		1		tCK	
Clock high level width	tCH	0.45	0.55	0.45	0.55	tCK	
Clock low level width	tCL	0.45	0.55	0.45	0.55	tCK	
DQ Output data access time from CK/CK	CL=2	tAC	2	8	2.5	8	ns
	CL=3		2	6	2.5	6	
DQS Output data access time from CK/CK	CL=2	tDQSK	2	8	2.5	8	ns
	CL=3		2	6	2.5	6	
Data strobe edge to output data edge	tDQSQ		0.6		0.7	ns	
Read Preamble	CL=2	tRPRE	0.5	1.1	0.5	1.1	tCK
	CL=3		0.9	1.1	0.9	1.1	
Read Postamble	tRPST	0.4	0.6	0.4	0.6	tCK	
CK to valid DQS-in	tDQSS	0.75	1.25	0.75	1.25	tCK	
DQS-in setup time	tWPRES	0		0		ns	4
DQS-in hold time	tWPREH	0.25		0.25		tCK	
DQS-in high level width	tDQSH	0.4	0.6	0.4	0.6	tCK	
DQS-in low level width	tDQSL	0.4	0.6	0.4	0.6	tCK	
DQS falling edge to CK setup time	tDSS	0.2		0.2		tCK	
DQS falling edge hold time from CK	tDSH	0.2		0.2		tCK	
DQS-in cycle time	tDSC	0.9	1.1	0.9	1.1	tCK	
Address and Control Input setup time	tIS	1.3		1.5		ns	1
Address and Control Input hold time	tIH	1.3		1.5		ns	1
Address & Control input pulse width	tIPW	2.6		3.0			1
DQ & DM setup time to DQS	tDS	0.9		1.2		ns	5,6
DQ & DM hold time to DQS	tDH	0.9		1.2		ns	5,6
DQ & DM input pulse width	tDIPW	1.8		2.4		ns	
DQ & DQS low-impedance time from CK/CK	tLZ	1.0		1.0		ns	
DQ & DQS high-impedance time from CK/CK	tHZ		6.0		7.0	ns	
DQS write postamble time	tWPST	0.4	0.6	0.4	0.6	tCK	
DQS write preamble time	tWPRE	0.25		0.25		tCK	

K4X51323PC - 7(8)E/G

Preliminary
Mobile-DDR SDRAM

Parameter	Symbol	DDR266		DDR222		Unit	Note
		Min	Max	Min	Max		
Refresh interval time	tREF		64		64	ms	
Mode register set cycle time	tMRD	2		2		tCK	
Power down exit time	tPDEX	1*tCK +tIS		1*tCK +tIS		ns	
CKE min. pulse width(high and low pulse width)	tCKE	2		2		tCK	
Auto refresh cycle time	tRFC	80		90		ns	7
Exit self refresh to active command	tXSR	120		120		ns	
Data hold from DQS to earliest DQ edge	tQH	tHPmin - tQHS		tHPmin - tQHS		ns	
Data hold skew factor	tQHS		0.75		1.0	ns	
Clock half period	tHP	tCLmin or tCHmin		tCLmin or tCHmin		ns	

www.DataSheet4U.com



Note :

1. Input Setup/Hold Slew Rate Derating

Input Setup/Hold Slew Rate (V/ns)	Δt_{IS} (ps)	Δt_{IH} (ps)
1.0	0	0
0.8	+50	+50
0.6	+100	+100

This derating table is used to increase t_{IS}/t_{IH} in the case where the input slew rate is below 1.0V/ns.

2. Minimum 3CLK of $t_{DAL}(= t_{WR} + t_{RP})$ is required because it need minimum 2CLK for t_{WR} and minimum 1CLK for t_{RP} .3. $t_{AC}(\text{min})$ value is measured at the high $V_{dd}(1.95V)$ and cold temperature(-25°C).

$t_{AC}(\text{max})$ value is measured at the low $V_{dd}(1.7V)$ and hot temperature(85°C).

t_{AC} is measured in the device with half driver strength and under the AC output load condition (Fig.7 in next Page).

4. The specific requirement is that DQS be valid(High or Low) on or before this CK edge. The case shown(DQS going from High_Z to logic Low) applies when no writes were previously in progress on the bus. If a previous write was in progress, DQS could be High at this time, depending on t_{DQSS} .

5. I/O Setup/Hold Slew Rate Derating

I/O Setup/Hold Slew Rate (V/ns)	Δt_{DS} (ps)	Δt_{DH} (ps)
1.0	0	0
0.8	+75	+75
0.6	+150	+150

This derating table is used to increase t_{DS}/t_{DH} in the case where the I/O slew rate is below 1.0V/ns.

6. I/O Delta Rise/Fall Rate(1/slew-rate) Derating

Delta Rise/Fall Rate (ns/V)	Δt_{DS} (ps)	Δt_{DH} (ps)
0	0	0
± 0.25	+50	+50
± 0.5	+100	+100

This derating table is used to increase t_{DS}/t_{DH} in the case where the DQ and DQS slew rates differ. The Delta Rise/Fall Rate is calculated as $1/\text{SlewRate1}-1/\text{SlewRate2}$. For example, if slew rate 1 = 1.0V/ns and slew rate 2 =0.8V/ns, then the Delta Rise/Fall Rate =-0.25ns/V.

7. Maximum burst refresh cycle : 8

K4X51323PC - 7(8)E/G

Mobile-DDR SDRAM

AC Operating Test Conditions ($V_{DD} = 1.7V$ to $1.95V$, $T_c = -25$ to $85^\circ C$)

Parameter	Value	Unit
AC input levels (V_{ih}/V_{il})	$0.8 \times V_{DDQ} / 0.2 \times V_{DDQ}$	V
Input timing measurement reference level	$0.5 \times V_{DDQ}$	V
Input signal minimum slew rate	1.0	V/ns
Output timing measurement reference level	$0.5 \times V_{DDQ}$	V
Output load condition	See Figure.7	

www.DataSheet4U.com

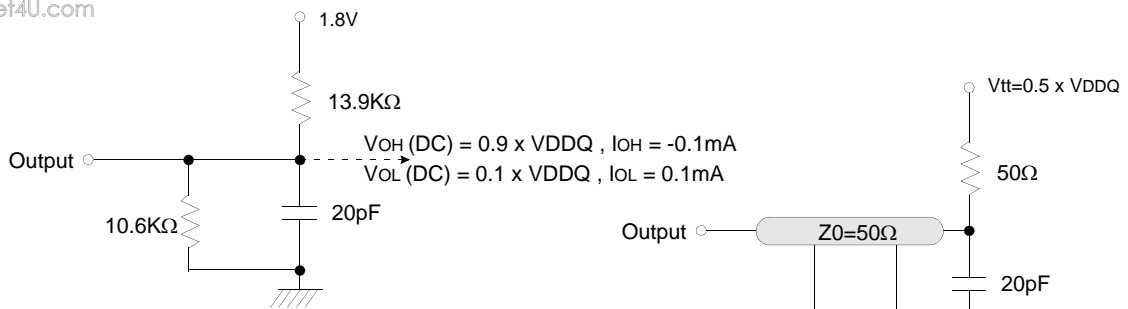

Figure.6 DC Output Load Circuit

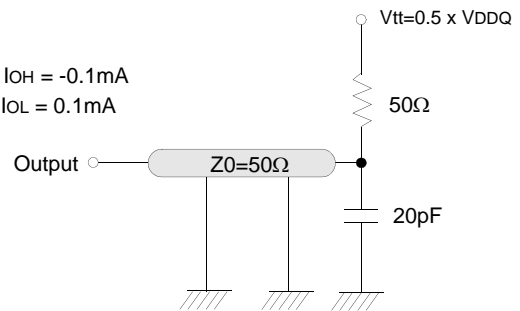

Figure.7 AC Output Load Circuit

Input/Output Capacitance ($V_{DD}=1.8$, $V_{DDQ}=1.8V$, $T_c = 25^\circ C$, $f=1MHz$)

Parameter	Symbol	Min	Max	Unit
Input capacitance (A0 ~ A12, BA0 ~ BA1, CKE, \overline{CS} , \overline{RAS} , \overline{CAS} , \overline{WE})	CIN1	1.5	3.0	pF
Input capacitance(CK, \overline{CK})	CIN2	1.5	3.5	pF
Data & DQS input/output capacitance	COUT	2.0	4.5	pF
Input capacitance(DM)	CIN3	2.0	4.5	pF

AC Overshoot/Undershoot Specification for Address & Control Pins

Parameter	Specification
Maximum peak Amplitude allowed for overshoot area	0.9V
Maximum peak Amplitude allowed for undershoot area	0.9V
Maximum overshoot area above VDD	3V-ns
Maximum undershoot area below VSS	3V-ns

www.DataSheet4U.com

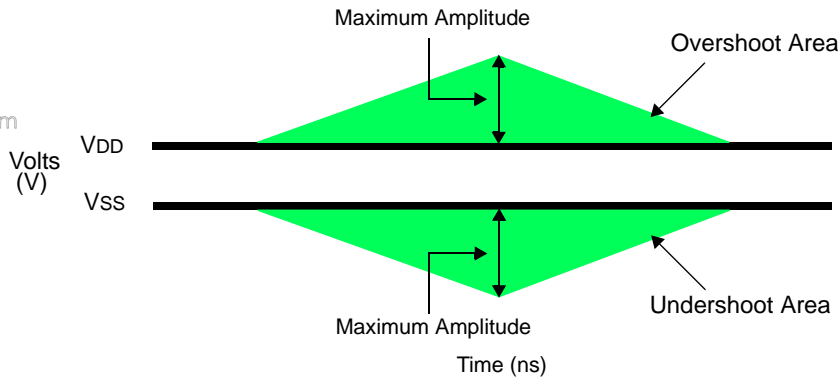

Figure.8 AC Overshoot and Undershoot Definition for Address and Control Pins

AC Overshoot/Undershoot Specification for CLK, DQ, DQS and DM Pins

Parameter	Specification
Maximum peak Amplitude allowed for overshoot area	0.9V
Maximum peak Amplitude allowed for undershoot area	0.9V
Maximum overshoot area above VDDQ	3V-ns
Maximum undershoot area below VSSQ	3V-ns

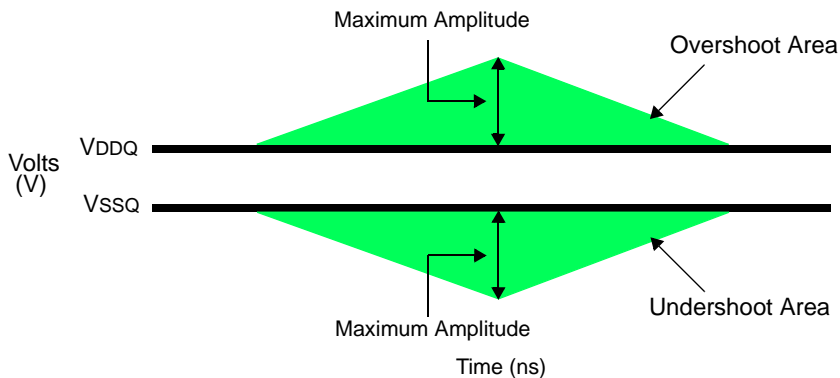

Figure.9 AC Overshoot and Undershoot Definition for CLK, DQ, DQS and DM Pins

Command Truth Table (V=Valid, X=Don't Care, H=Logic High, L=Logic Low)

COMMAND		CKEn-1	CKEn	\overline{CS}	\overline{RAS}	\overline{CAS}	\overline{WE}	BA0,1	A10/AP	A12,A11, A9 ~ A0	Note
Register	Mode Register Set	H	X	L	L	L	L	OP CODE			1, 2
Refresh	Auto Refresh	H	H	L	L	L	H	X			3
	Entry		L								3
	Self Refresh	L	H	L	H	H	H	X			3
				Exit	H	X	X				X
Bank Active & Row Addr.		H	X	L	L	H	H	V	Row Address		
Read & Column Address	Auto Precharge Disable	H	X	L	H	L	H	V	L	Column Address (A0~A8)	4
	Auto Precharge Enable								H		4
Write & Column Address	Auto Precharge Disable	H	X	L	H	L	L	V	L	Column Address (A0~A8)	4
	Auto Precharge Enable								H		4, 6
Deep Power Down	Entry	H	L	L	H	H	L	X			
	Exit	L	H	H	X	X	X				
Burst Stop		H	X	L	H	H	L	X			7
Precharge	Bank Selection	H	X	L	L	H	L	V	L	X	
	All Banks							X	H		5
Active Power Down	Entry	H	L	H	X	X	X	X			
	Exit			L	H	X	X				X
Precharge Power Down	Entry	H	L	H	X	X	X	X			
				L	H	H	H				
	Exit	L	H	H	X	X	X				
				L	V	V	V				
DM		H	X					X			8
No operation (NOP) : Not defined		H	X	H	X	X	X	X			9
				L	H	H	H				9

Note :

- OP Code : Operand Code. A0 ~ A12 & BA0 ~ BA1 : Program keys. (@EMRS/MRS)
- EMRS/ MRS can be issued only at all banks precharge state.
A new command can be issued 2 clock cycles after EMRS or MRS.
- Auto refresh functions are same as the CBR refresh of DRAM.
The automatical precharge without row precharge command is meant by "Auto".
Auto/self refresh can be issued only at all banks precharge state.
- BA0 ~ BA1 : Bank select addresses.
- If A10/AP is "High" at row precharge, BA0 and BA1 are ignored and all banks are selected.
- During burst write with auto precharge, new read/write command can not be issued.
Another bank read/write command can be issued after the end of burst.
New row active of the associated bank can be issued at tRP after the end of burst.
- Burst stop command is valid at every burst length.
- DM sampled at the rising and falling edges of the DQS and Data-in are masked at the both edges (Write DM latency is 0).
- This combination is not defined for any function, which means "No Operation(NOP)" in DDR SDRAM.

Functional Truth Table

Current State	\overline{CS}	\overline{RAS}	\overline{CAS}	\overline{WE}	Address	Command	Action
PRECHARGE STANDBY	L	H	H	L	X	Burst Stop	ILLEGAL ^{*2}
	L	H	L	X	BA, CA, A10	READ/WRITE	ILLEGAL ^{*2}
	L	L	H	H	BA, RA	Active	Bank Active, Latch RA
	L	L	H	L	BA, A10	PRE/PREA	ILLEGAL ^{*4}
	L	L	L	H	X	Refresh	AUTO-Refresh ^{*5}
	L	L	L	L	Op-Code, Mode-Add	MRS	Mode Register Set ^{*5}
ACTIVE STANDBY	L	H	H	L	X	Burst Stop	NOP
	L	H	L	H	BA, CA, A10	READ/READA	Begin Read, Latch CA, Determine Auto-Precharge
	L	H	L	L	BA, CA, A10	WRITE/WRITEA	Begin Write, Latch CA, Determine Auto-Precharge
	L	L	H	H	BA, RA	Active	Bank Active/ILLEGAL ^{*2}
	L	L	H	L	BA, A10	PRE/PREA	Precharge/Precharge All
	L	L	L	H	X	Refresh	ILLEGAL
	L	L	L	L	Op-Code, Mode-Add	MRS	ILLEGAL
READ	L	H	H	L	X	Burst Stop	Terminate Burst
	L	H	L	H	BA, CA, A10	READ/READA	Terminate Burst, Latch CA, Begin New Read, Determine Auto-Precharge ^{*3}
	L	H	L	L	BA, CA, A10	WRITE/WRITEA	ILLEGAL
	L	L	H	H	BA, RA	Active	Bank Active/ILLEGAL ^{*2}
	L	L	H	L	BA, A10	PRE/PREA	Terminate Burst, Precharge
	L	L	L	H	X	Refresh	ILLEGAL
	L	L	L	L	Op-Code, Mode-Add	MRS	ILLEGAL

www.DataSheet4U.com

Functional truth table

Current State	\overline{CS}	\overline{RAS}	\overline{CAS}	\overline{WE}	Address	Command	Action
WRITE	L	H	H	L	X	Burst Stop	ILLEGAL
	L	H	L	H	BA, CA, A10	READ/READA	Terminate Burst With DM=High, Latch CA, Begin Read, Determine Auto-Precharge* ³
	L	H	L	L	BA, CA, A10	WRITE/WRITEA	Terminate Burst, Latch CA, Begin new Write, Determine Auto-Precharge* ³
	L	L	H	H	BA, RA	Active	Bank Active/ILLEGAL* ²
	L	L	H	L	BA, A10	PRE/PREA	Terminate Burst With DM=High, Precharge
	L	L	L	H	X	Refresh	ILLEGAL
	L	L	L	L	Op-Code, Mode-Add	MRS	ILLEGAL
READ with AUTO PRECHARGE* ⁶ (READA)	L	H	H	L	X	Burst Stop	ILLEGAL
	L	H	L	H	BA, CA, A10	READ/READA	*6
	L	H	L	L	BA, CA, A10	WRITE/WRITEA	ILLEGAL
	L	L	H	H	BA, RA	Active	*6
	L	L	H	L	BA, A10	PRE/PREA	*6
	L	L	L	H	X	Refresh	ILLEGAL
	L	L	L	L	Op-Code, Mode-Add	MRS	ILLEGAL
WRITE with AUTO RECHARGE* ⁷ (WRITEA)	L	H	H	L	X	Burst Stop	ILLEGAL
	L	H	L	H	BA, CA, A10	READ/READA	*7
	L	H	L	L	BA, CA, A10	WRITE/WRITEA	*7
	L	L	H	H	BA, RA	Active	*7
	L	L	H	L	BA, A10	PRE/PREA	*7
	L	L	L	H	X	Refresh	ILLEGAL
	L	L	L	L	Op-Code, Mode-Add	MRS	ILLEGAL

www.DataSheet4U

Functional truth table

Current State	\overline{CS}	\overline{RAS}	\overline{CAS}	\overline{WE}	Address	Command	Action
PRECHARGING (DURING tRP)	L	H	H	L	X	Burst Stop	ILLEGAL ^{*2}
	L	H	L	X	BA, CA, A10	READ/WRITE	ILLEGAL ^{*2}
	L	L	H	H	BA, RA	Active	ILLEGAL ^{*2}
	L	L	H	L	BA, A10	PRE/PREA	NOP ^{*4} (Idle after tRP)
	L	L	L	H	X	Refresh	ILLEGAL
	L	L	L	L	Op-Code, Mode-Add	MRS	ILLEGAL
ROW ACTIVATING (FROM ROW ACTIVE TO tRCD)	L	H	H	L	X	Burst Stop	ILLEGAL ^{*2}
	L	H	L	X	BA, CA, A10	READ/WRITE	ILLEGAL ^{*2}
	L	L	H	H	BA, RA	Active	ILLEGAL ^{*2}
	L	L	H	L	BA, A10	PRE/PREA	ILLEGAL ^{*2}
	L	L	L	H	X	Refresh	ILLEGAL
	L	L	L	L	Op-Code, Mode-Add	MRS	ILLEGAL
WRITE RECOVERING (DURING tWR OR tCDLR)	L	H	H	L	X	Burst Stop	ILLEGAL ^{*2}
	L	H	L	H	BA, CA, A10	READ	ILLEGAL ^{*2}
	L	H	L	L	BA, CA, A10	WRITE	WRITE
	L	L	H	H	BA, RA	Active	ILLEGAL ^{*2}
	L	L	H	L	BA, A10	PRE/PREA	ILLEGAL ^{*2}
	L	L	L	H	X	Refresh	ILLEGAL
	L	L	L	L	Op-Code, Mode-Add	MRS	ILLEGAL

www.DataSheet4U.com

Functional truth table

Current State	\overline{CS}	\overline{RAS}	\overline{CAS}	\overline{WE}	Address	Command	Action
RE-FRESHING	L	H	H	L	X	Burst Stop	ILLEGAL
	L	H	L	X	BA, CA, A10	READ/WRITE	ILLEGAL
	L	L	H	H	BA, RA	Active	ILLEGAL
	L	L	H	L	BA, A10	PRE/PREA	ILLEGAL
	L	L	L	H	X	Refresh	ILLEGAL
	L	L	L	L	Op-Code, Mode-Add	MRS	ILLEGAL
MODE REGISTER SETTING	L	H	H	L	X	Burst Stop	ILLEGAL
	L	H	L	X	BA, CA, A10	READ/WRITE	ILLEGAL
	L	L	H	H	BA, RA	Active	ILLEGAL
	L	L	H	L	BA, A10	PRE/PREA	ILLEGAL
	L	L	L	H	X	Refresh	ILLEGAL
	L	L	L	L	Op-Code, Mode-Add	MRS	ILLEGAL

www.DataSheet4U.com

Functional truth table

Current State	CKE _{n-1}	CKE _n	\overline{CS}	\overline{RAS}	\overline{CAS}	\overline{WE}	Add	Action
SELF-REFRESHING ⁸	L	H	H	X	X	X	X	Exit Self-Refresh
	L	H	L	H	H	H	X	Exit Self-Refresh
	L	H	L	H	H	L	X	ILLEGAL
	L	H	L	H	L	X	X	ILLEGAL
	L	H	L	L	X	X	X	ILLEGAL
	L	L	X	X	X	X	X	NOPeration(Maintain Self-Refresh)
POWER DOWN	L	H	X	X	X	X	X	Exit Power Down(Idle after tPDEX)
	L	L	X	X	X	X	X	NOPeration(Maintain Power Down)
DEEP POWER DOWN	L	H	H	X	X	X	X	Exit Deep Power Down ¹⁰
	L	L	X	X	X	X	X	NOPeration(Maintain Deep Power Down)
ALL BANKS IDLE ⁹	H	H	X	X	X	X	X	Refer to Function True Table
	H	L	L	L	L	H	X	Enter Self-Refresh
	H	L	H	X	X	X	X	Enter Power Down
	H	L	L	H	H	H	X	Enter Power Down
	H	L	L	H	H	L	X	Enter Deep Power Down
	H	L	L	H	H	L	X	ILLEGAL
	H	L	L	H	L	X	X	ILLEGAL
	H	L	L	L	X	X	X	ILLEGAL
ANY STATE other than listed above	L	X	X	X	X	X	X	Refer to Current State=Power Down
	H	H	X	X	X	X	X	Refer to Function Truth Table

ABBREVIATIONS :
H=High Level, L=Low level, X=Don't Care

- Note :**
- All entries assume that CKE was High during the preceding clock cycle and the current clock cycle.
 - ILLEGAL to bank in specified state ; function may be legal in the bank indicated by BA, depending on the state of that bank. (ILLEGAL = Device operation and/or data integrity are not guaranteed.)
 - Must satisfy bus contention, bus turn around and write recovery requirements.
 - NOP to bank precharging or in idle state. May precharge bank indicated by BA.
 - ILLEGAL if any bank is not idle.
 - Refer to "Read with Auto Precharge Timing Diagram" for detailed information.
 - Refer to "Write with Auto Precharge Timing Diagram" for detailed information.
 - CKE Low to High transition will re-enable CK, CK and other inputs asynchronously. A minimum setup time must be satisfied before issuing any command other than EXIT.
 - Power-Down, Self-Refresh and Deep Power Down Mode can be entered only from All Bank Idle state.
 - The Deep Power Down Mode is exited by asserting CKE high and full initialization is required after exiting Deep Power Down Mode.

