

2SK622

SILICON N-CHANNEL MOS FET

HIGH SPEED POWER SWITCHING

■ FEATURES

- Low On-Resistance
- High Speed Switching
- Low Drive Current
- No Secondary Breakdown
- Suitable for Switching Regulator, DC-DC Converter and Motor Driver

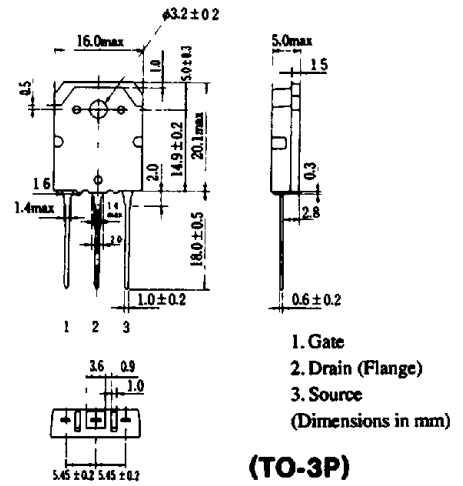
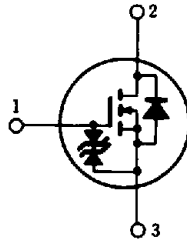

■ ABSOLUTE MAXIMUM RATINGS ($T_a=25^\circ\text{C}$)

Item	Symbol	Rating	Unit
Drain-Source Voltage	V_{DSS}	150	V
Gate-Source Voltage	V_{GSS}	± 20	V
Drain Current	I_D	20	A
Drain Peak Current	$I_{D(pulse)}$ *	80	A
Body-Drain Diode Reverse Drain Current	I_{DR}	20	A
Channel Dissipation	P_{ch} **	120	W
Channel Temperature	T_{ch}	150	$^\circ\text{C}$
Storage Temperature	T_{stg}	$-55 \sim +150$	$^\circ\text{C}$

*PW $\leq 10\mu\text{s}$, duty cycle $\leq 1\%$ **Value at $T_c=25^\circ\text{C}$

POWER VS. TEMPERATURE DERATING

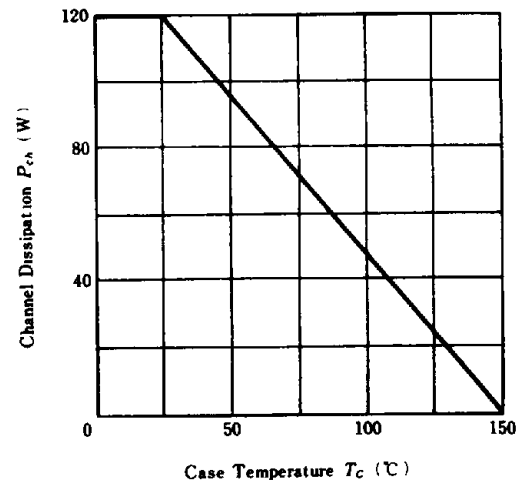

■ ELECTRICAL CHARACTERISTICS ($T_a=25^\circ\text{C}$)

Item	Symbol	Test Condition	min.	typ.	max.	Unit
Drain-Source Breakdown Voltage	$V_{(BR)DSS}$	$I_D=10\text{mA}$, $V_{GS}=0$	150	—	—	V
Gate-Source Breakdown Voltage	$V_{(BR)GSS}$	$I_G=\pm 100\mu\text{A}$, $V_{DS}=0$	± 20	—	—	V
Gate-Source Leak Current	I_{GSS}	$V_{GS}=\pm 16\text{V}$, $V_{DS}=0$	—	—	± 10	μA
Zero Gate Voltage Drain Current	I_{DSS}	$V_{DS}=120\text{V}$, $V_{GS}=0$	—	—	250	μA
Gate-Source Cutoff Voltage	$V_{GS(off)}$	$I_D=1\text{mA}$, $V_{DS}=10\text{V}$	2.0	—	4.0	V
Static Drain-Source on State Resistance	$R_{DS(on)}$	$I_D=10\text{A}$, $V_{GS}=10\text{V}$ *	—	0.06	0.075	Ω
Forward Transfer Admittance	$ y_{fs} $	$I_D=10\text{A}$, $V_{DS}=10\text{V}$ *	9	15	—	S
Input Capacitance	C_{iss}	$V_{DS}=10\text{V}$, $V_{GS}=0$, $f=1\text{MHz}$	—	2200	—	pF
Output Capacitance	C_{oss}		—	1000	—	pF
Reverse Transfer Capacitance	C_{rss}		—	220	—	pF
Turn-on Delay Time	$t_{d(on)}$		$I_D=10\text{A}$, $V_{GS}=10\text{V}$, $R_L=3\Omega$	—	35	—
Rise Time	t_r	—		190	—	ns
Turn-off Delay Time	$t_{d(off)}$	—		200	—	ns
Fall Time	t_f	—		160	—	ns
Body-Drain Diode Forward Voltage	V_{DF}	$I_F=20\text{A}$, $V_{GS}=0$	—	1.2	—	V
Body-Drain Diode Reverse Recovery Time	t_{rr}	$I_F=20\text{A}$, $V_{GS}=0$, $di_F/dt=50\text{A}/\mu\text{s}$	—	250	—	ns

*Pulse Test

MAXIMUM SAFE OPERATION AREA

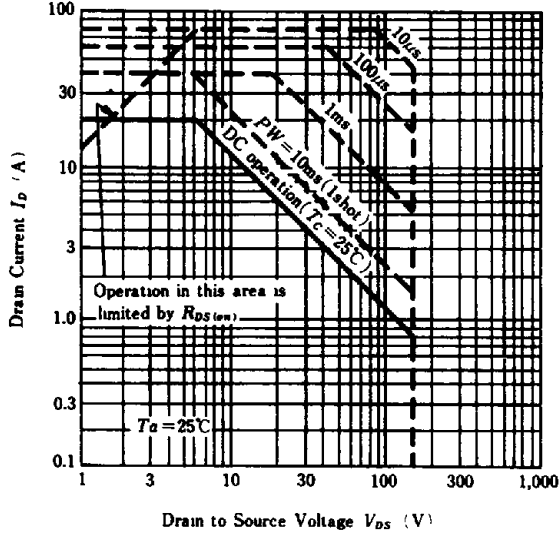

TYPICAL OUTPUT CHARACTERISTICS

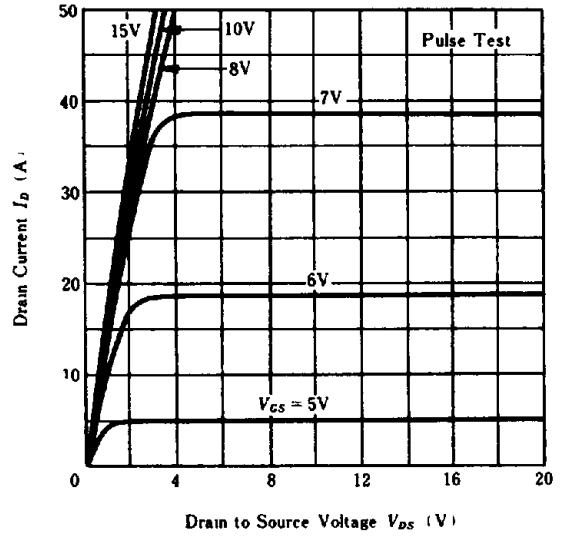

TYPICAL TRANSFER CHARACTERISTICS

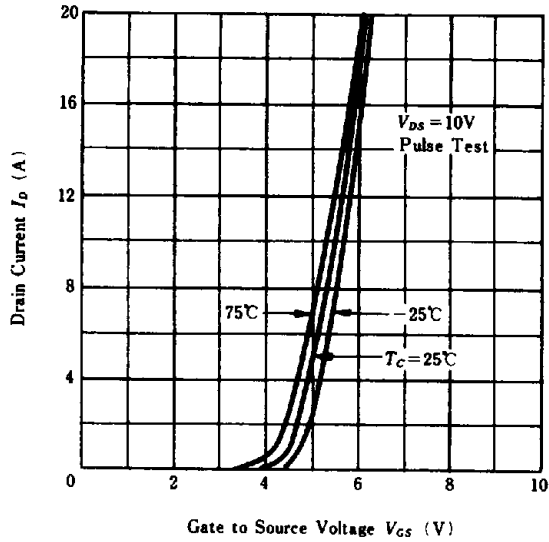

DRAIN-SOURCE SATURATION VOLTAGE VS. GATE-SOURCE VOLTAGE

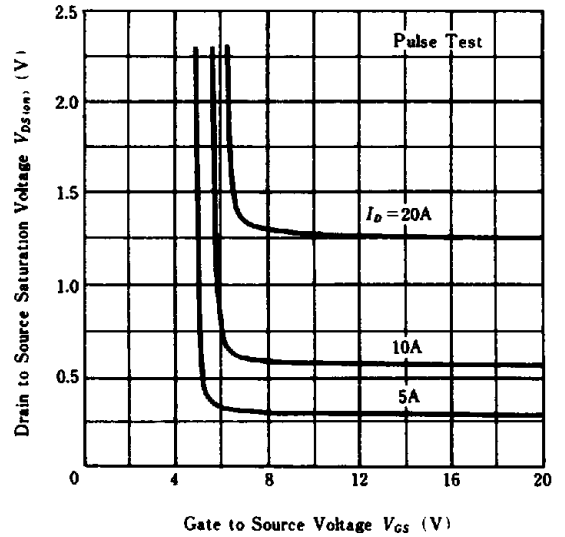

STATIC DRAIN-SOURCE ON STATE RESISTANCE VS. DRAIN CURRENT

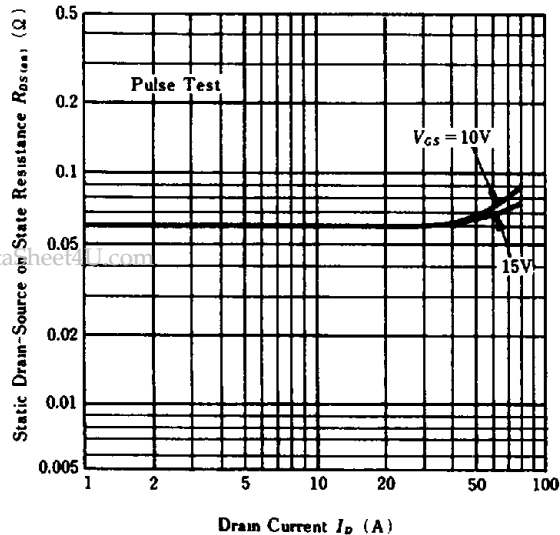

STATIC DRAIN-SOURCE ON STATE RESISTANCE VS. TEMPERATURE

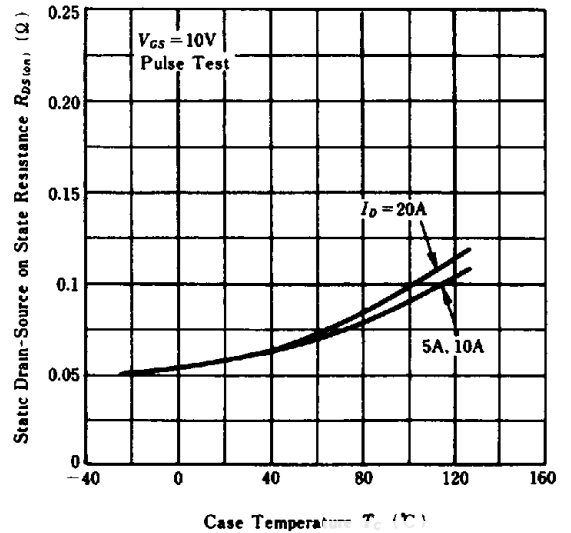

www.DataSheet4U.com

FORWARD TRANSFER ADMITTANCE VS. DRAIN CURRENT

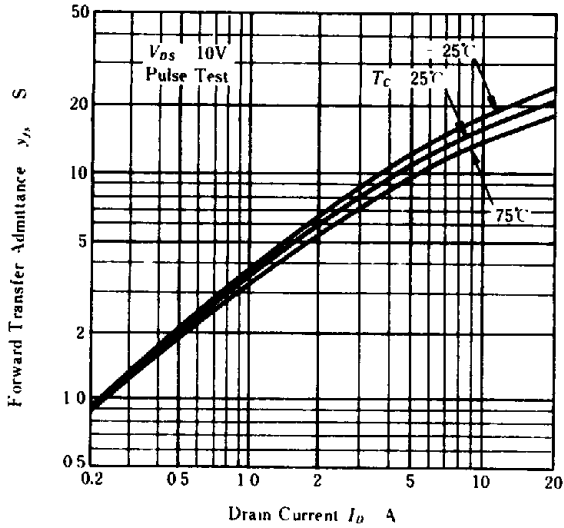

BODY-DRAIN DIODE REVERSE RECOVERY TIME

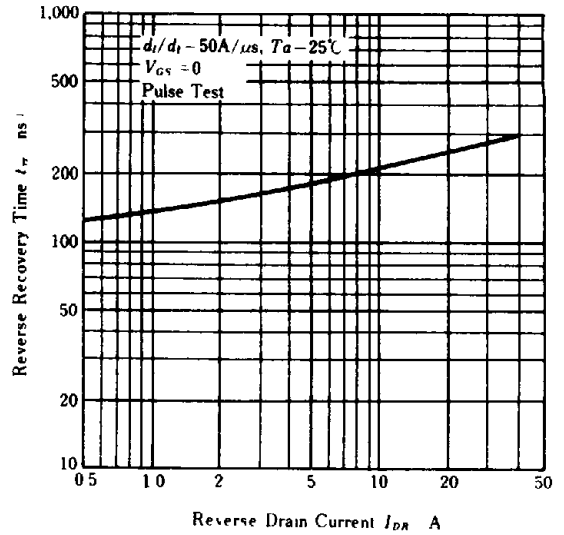

TYPICAL CAPACITANCE VS. DRAIN-SOURCE VOLTAGE

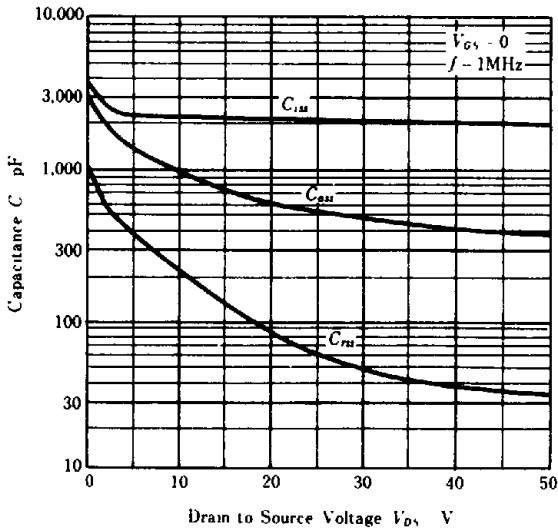

DYNAMIC INPUT CHARACTERISTICS

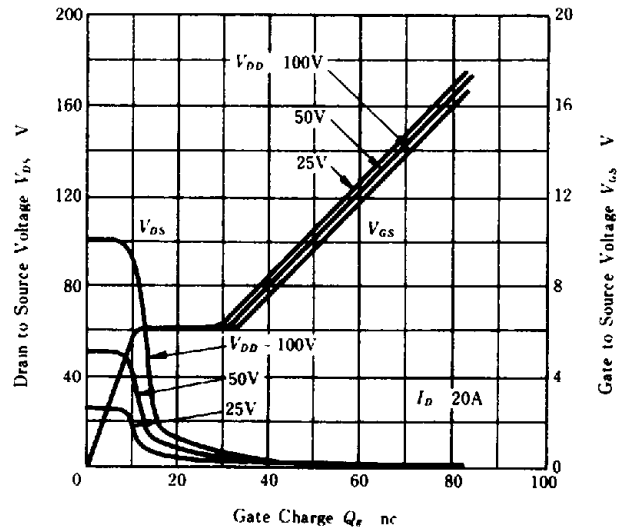

SWITCHING CHARACTERISTICS

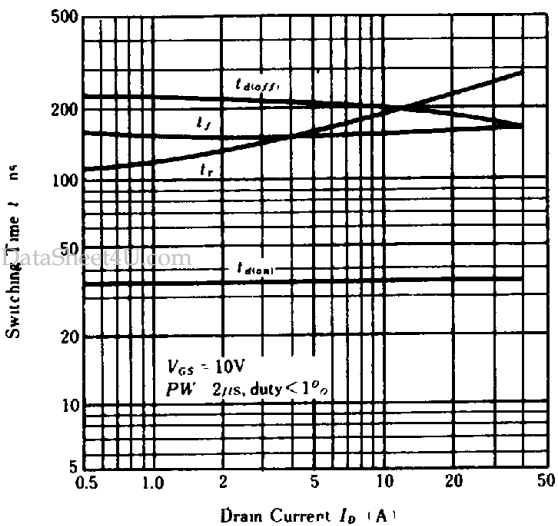

REVERSE DRAIN CURRENT VS. SOURCE TO DRAIN VOLTAGE

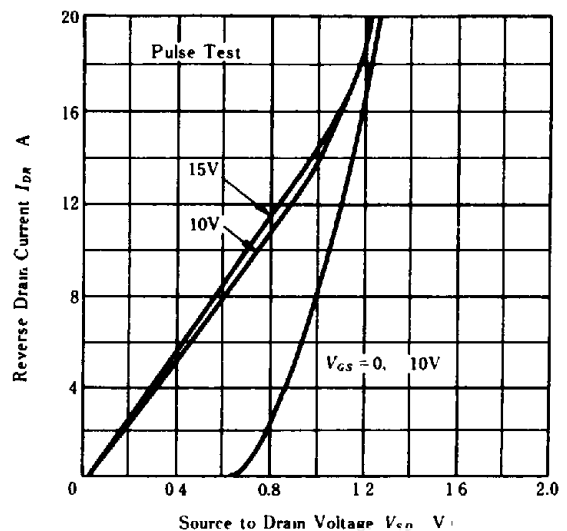

www.datasheet4u.com

NORMALIZED TRANSIENT THERMAL IMPEDANCE VS. PULSE WIDTH

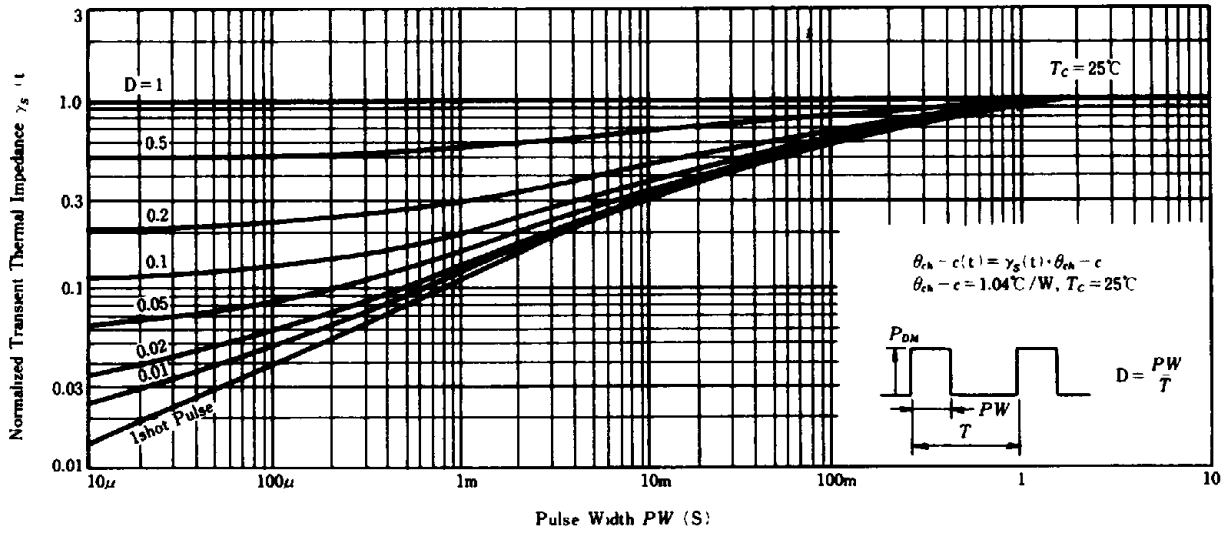

SWITCHING TIME TEST CIRCUIT

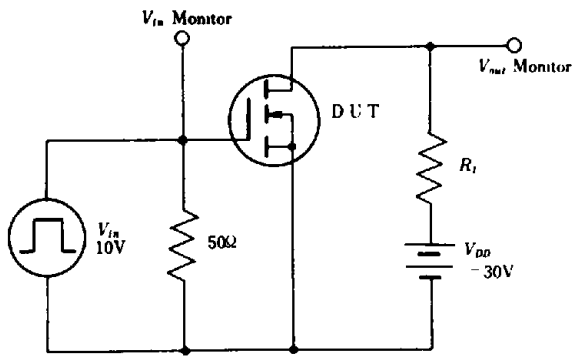

WAVEFORMS

