

# 2SK682, 2SK683

## SILICON N-CHANNEL MOS FET

### HIGH SPEED POWER SWITCHING

#### ■ FEATURES

- Low On-Resistance
- High Speed Switching
- Low Drive Current
- No Secondary Breakdown
- Suitable for Switching Regulator, DC-DC Converter and Motor Driver

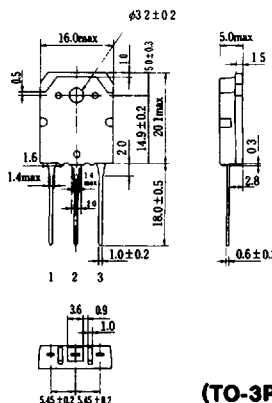
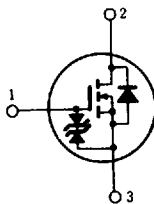

1. Gate
  2. Drain (Flange)
  3. Source
- (Dimensions in mm)

#### (TO-3P)

#### POWER VS.

#### TEMPERATURE DERATING

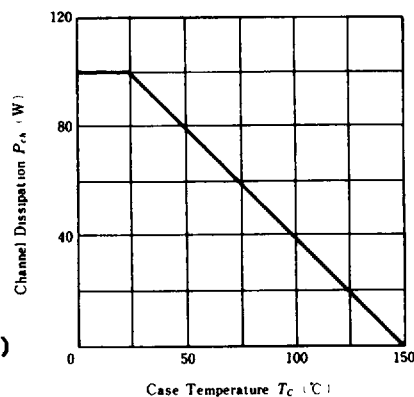

#### ■ ABSOLUTE MAXIMUM RATINGS ( $T_a=25^\circ\text{C}$ )

Item	Symbol	2SK682	2SK683	Unit
Drain-Source Voltage	$V_{DS}$	450	500	V
Gate-Source Voltage	$V_{GS}$	±20		V
Drain Current	$I_D$	12		A
Drain Peak Current	$I_{D(pulse)}$ *	48		A
Body-Drain Diode Reverse Drain Current	$I_{DR}$	12		A
Channel Dissipation	$P_{ch}$ **	100		W
Channel Temperature	$T_{ch}$	150		°C
Storage Temperature	$T_{stg}$	-55 ~ +150		°C

\*PW ≤ 10μs, duty cycle ≤ 1%

\*\*Value at  $T_c=25^\circ\text{C}$

HITACHI/(OPTOELECTRONICS)

#### ■ ELECTRICAL CHARACTERISTICS ( $T_a=25^\circ\text{C}$ )

Item	Symbol	Test Condition	min.	typ.	max.	Unit
Drain-Source Breakdown Voltage	2SK682	$I_D=10\text{mA}, V_{GS}=0$	450	—	—	V
	2SK683		500	—	—	
Gate-Source Breakdown Voltage	$V_{(BR)GS}$	$I_C=\pm 100\mu\text{A}, V_{DS}=0$	±20	—	—	V
Gate-Source Leak Current	$I_{GSS}$	$V_{GS}=\pm 16\text{V}, V_{DS}=0$	—	—	±10	μA
Zero Gate Voltage Drain Current	2SK682	$V_{DS}=360\text{V}, V_{GS}=0$	—	—	250	μA
	2SK683		$V_{DS}=400\text{V}, V_{GS}=0$	—	—	
Gate-Source Cutoff Voltage	$V_{GS(off)}$	$I_D=1\text{mA}, V_{DS}=10\text{V}$	2.0	—	4.0	V
Static Drain-Source On State Resistance	2SK682	$I_D=6\text{A}, V_{GS}=10\text{V}^*$	—	0.4	0.55	Ω
	2SK683		—	0.45	0.60	
Forward Transfer Admittance	$ y_{fs} $	$I_D=6\text{A}, V_{DS}=10\text{V}^*$	6	10	—	S
Input Capacitance	$C_{iss}$	$V_{DS}=10\text{V}, V_{GS}=0, f=1\text{MHz}$	—	2050	—	pF
Output Capacitance	$C_{oss}$		—	720	—	pF
Reverse Transfer Capacitance	$C_{rss}$		—	80	—	pF
Turn-on Delay Time	$t_{d(on)}$		—	25	—	ns
Rise Time	$t_r$	$I_D=6\text{A}, V_{GS}=10\text{V}, R_L=5\Omega$	—	85	—	ns
Turn-off Delay Time	$t_{d(off)}$		—	145	—	ns
Fall Time	$t_f$		—	85	—	ns
Body-Drain Diode Forward Voltage	$V_{DF}$		$I_F=12\text{A}, V_{GS}=0$	—	1.0	—
Body-Drain Diode Reverse Recovery Time	$t_{rr}$	$I_F=12\text{A}, V_{GS}=0, di_F/dt=100\text{A}/\mu\text{s}$	—	120	—	ns

\*Pulse Test

**MAXIMUM SAFE OPERATION AREA**

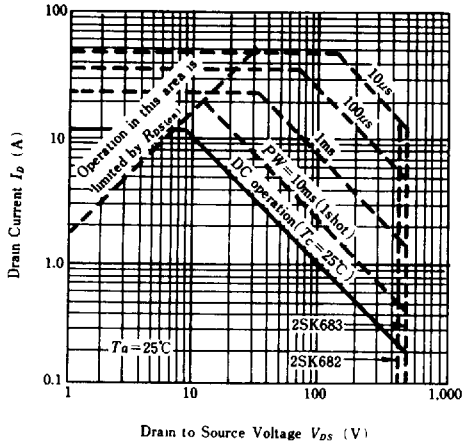

**TYPICAL OUTPUT CHARACTERISTICS**

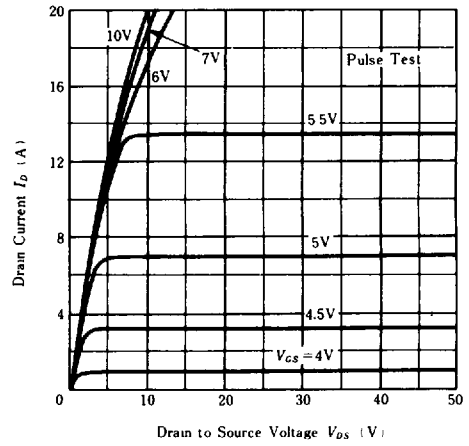

**TYPICAL TRANSFER CHARACTERISTICS**

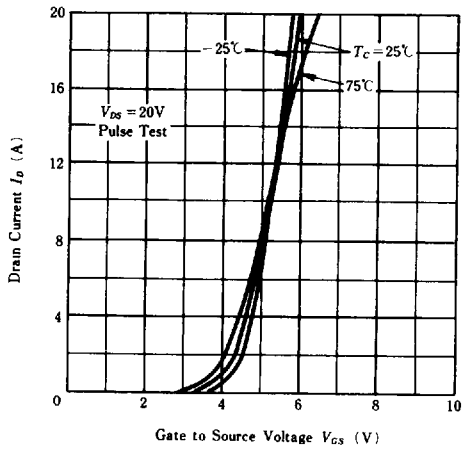

**DRAIN-SOURCE SATURATION VOLTAGE VS. GATE-SOURCE VOLTAGE**

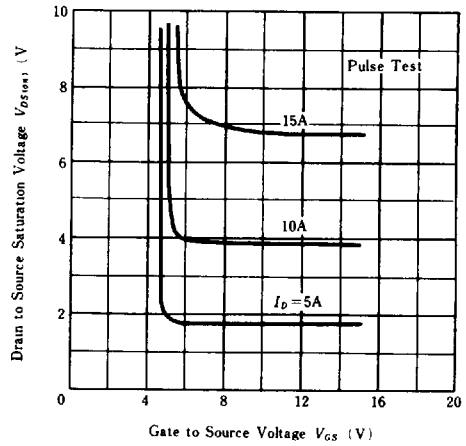

**STATIC DRAIN-SOURCE ON STATE RESISTANCE VS. DRAIN CURRENT**

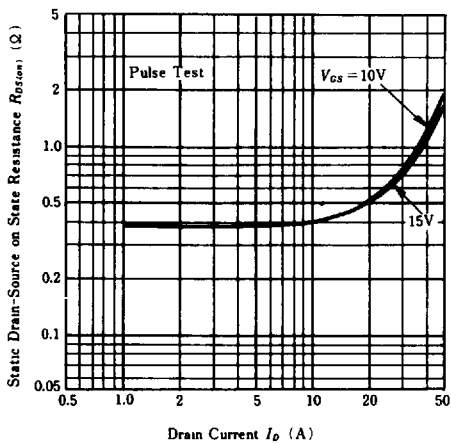

**STATIC DRAIN-SOURCE ON STATE RESISTANCE VS. TEMPERATURE**

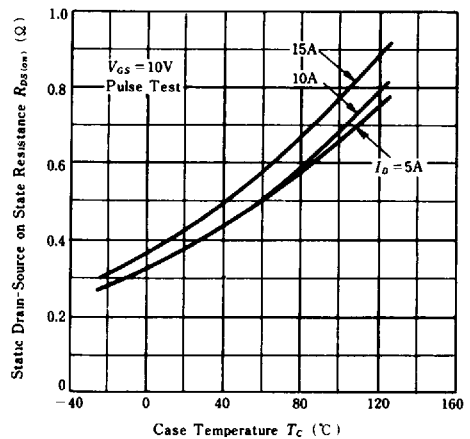

HITACHI/(OPTOELECTRONICS)

www.DataSheet4U.com

**FORWARD TRANSFER ADMITTANCE VS. DRAIN CURRENT**

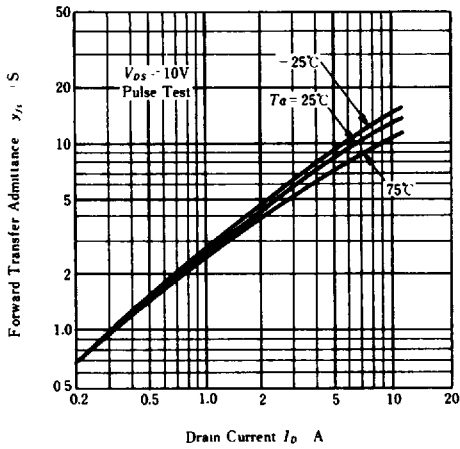

**BODY DRAIN DIODE REVERSE RECOVERY TIME**

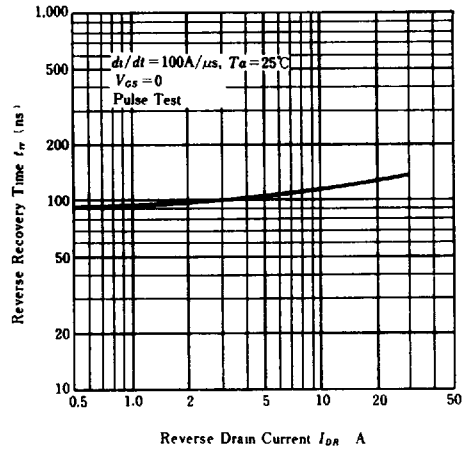

**TYPICAL CAPACITANCE VS. DRAIN-SOURCE VOLTAGE**

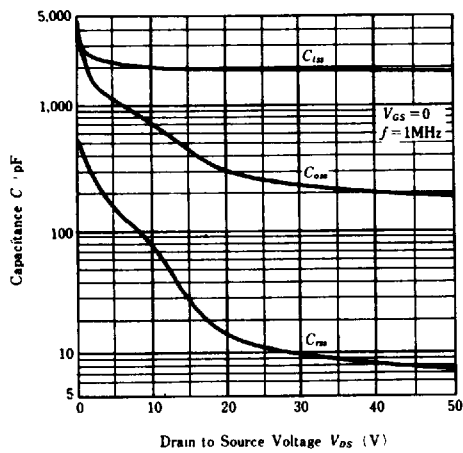

**DYNAMIC INPUT CHARACTERISTICS**

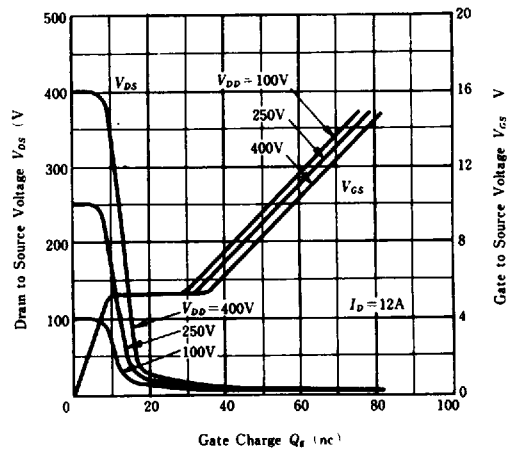

**SWITCHING CHARACTERISTICS**

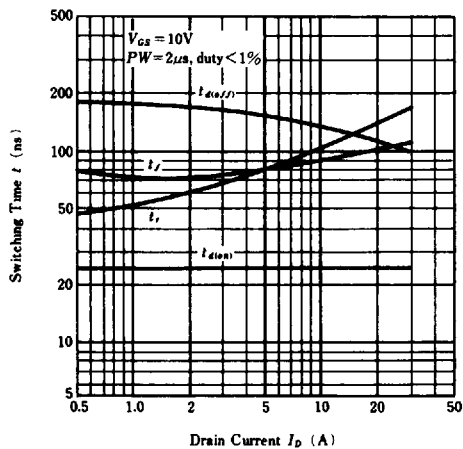

**REVERSE DRAIN CURRENT VS. SOURCE TO DRAIN VOLTAGE**

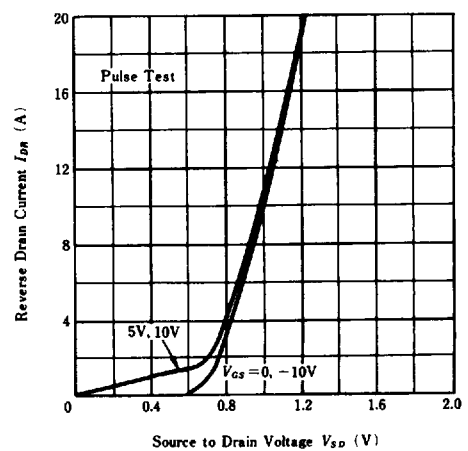

**NORMALIZED TRANSIENT THERMAL IMPEDANCE VS. PULSE WIDTH**

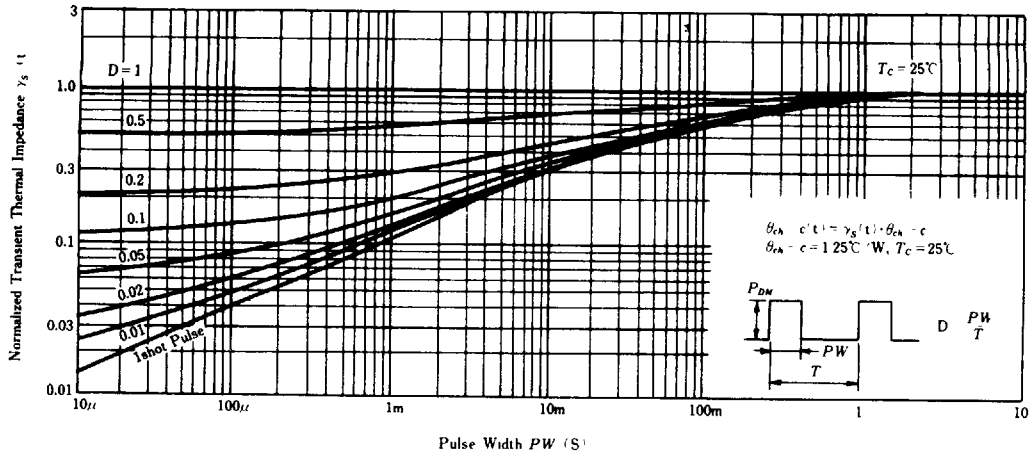

**SWITCHING TIME TEST CIRCUIT**

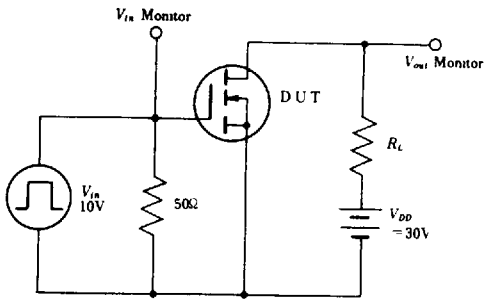

**WAVEFORMS**

