

MOS FIELD EFFECT POWER TRANSISTOR

2SK719

FAST SWITCHING
N-CHANNEL SILICON POWER MOS FET

PACKAGE DIMENSIONS

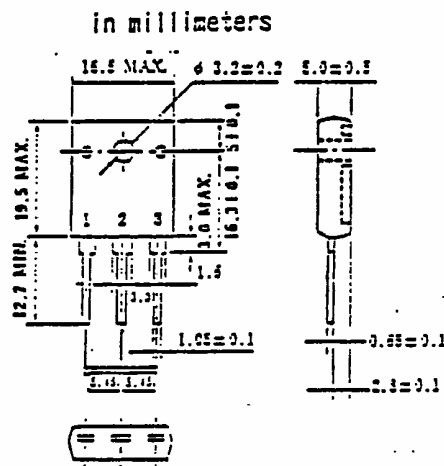

- 1 Gate
- 2 Drain
- 3 Source

FEATURES

- Suitable for switching power supplies, actuator controls, and pulse circuits
- Low $R_{DS(on)}$
- No second breakdown

ABSOLUTE MAXIMUM RATINGS ($T_a=25^\circ\text{C}$)

Drain to Source Voltage	V_{DSS}	900V
Gate to Source Voltage	V_{GS}	$\pm 20\text{V}$
Continuous Drain Current	$I_D(OC)$	$\pm 5\text{A}$
Total Power Dissipation	P_T	120W
Channel Temperature	T_{ch}	150°C
Storage Temperature	T_{stg}	-55~150 °C

* $T_c=25^\circ\text{C}$

ELECTRICAL CHARACTERISTICS ($T_a=25^\circ\text{C}$)

CHARACTERISTIC	SYMBOL	MIN.	TYP.	MAX.	UNIT	TEST CONDITIONS
Drain Leakage Current	I_{DSS}			100	μA	$V_{DS}=100\text{V}, V_{GS}=0$
Gate to Source Leakage Current	I_{GSS}			± 100	nA	$V_{GS}=\pm 20\text{V}, V_{DS}=0$
Gate to Source Cutoff Voltage	$V_{GS(off)}$	1.5		3.5	V	$V_{DS}=10\text{V}, I_D=-1\text{mA}$
Forward Transfer Admittance	$ y_{fs} $	1.0	2.5		S	$V_{DS}=20\text{V}, I_D=3.0\text{A}$
Drain to source On-State Resistance	$R_{DS(on)}$		3.2	4.0	Ω	$V_{GS}=10\text{V}, I_D=3.0\text{A}$
Input Capacitance	C_{iss}		950		pF	$V_{DS}=10\text{V}$
Output Capacitance	C_{oss}		170		pF	$V_{GS}=0$
Reverse Transfer Capacitance	C_{rss}		65		pF	$f=1\text{MHz}$
Turn-On Delay Time	$t_{d(on)}$		15		ns	$I_D=3.0\text{A}, V_{GS}=10\text{V}$
Rise Time	t_r		40		ns	$V_{GS(on)}=10\text{V}$
Turn-off Delay Time	$t_{d(off)}$		80		ns	$R_L=100\Omega$
Full Time	t_f		20		ns	

TURN-ON AND TURN-OFF TIME TEST CIRCUIT

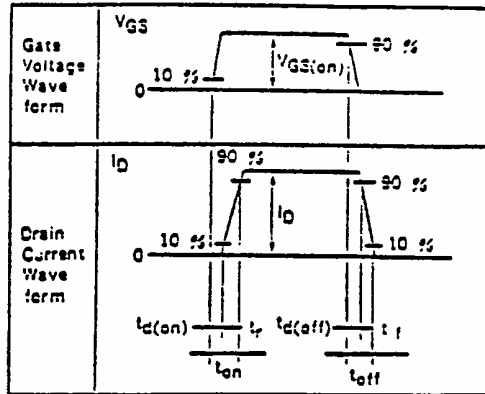
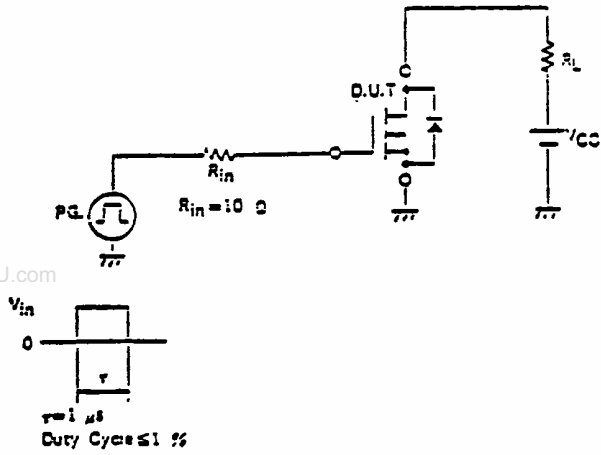

DERATING FACTOR OF FORWARD BIAS SAFE OPERATING AREA

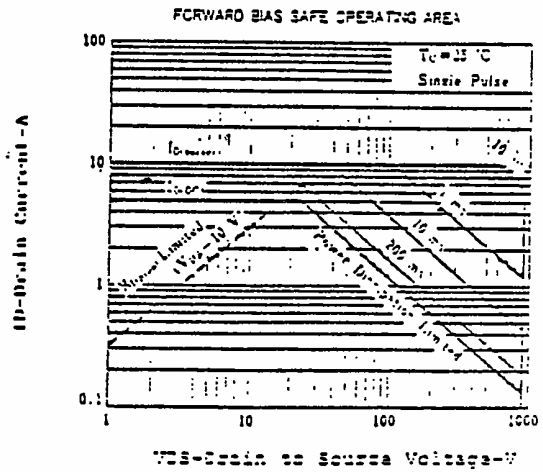
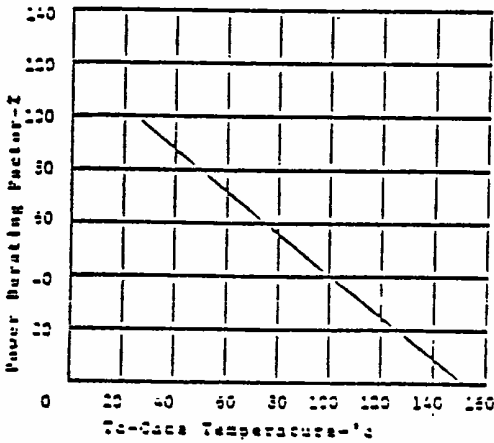

TOTAL POWER DISSIPATION vs. CASE TEMPERATURE

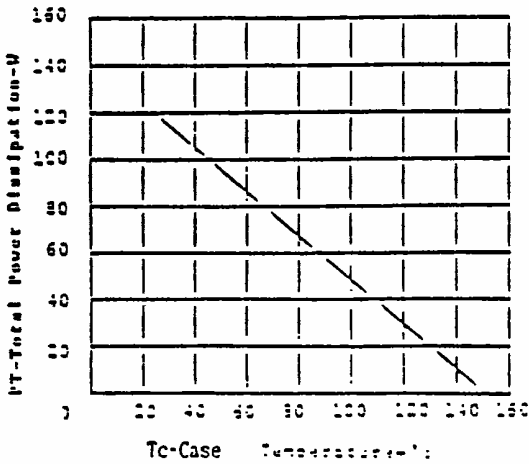

DRAIN CURRENT vs. DRAIN TO SOURCE VOLTAGE

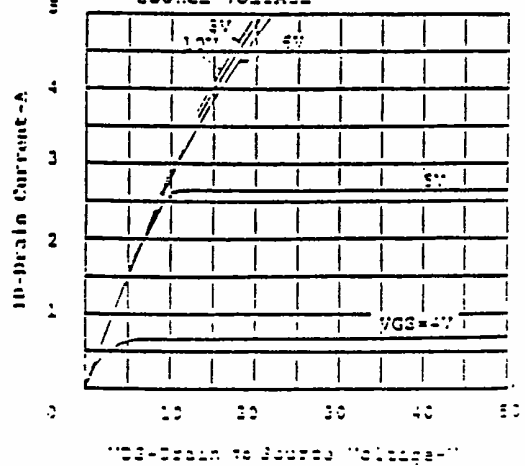

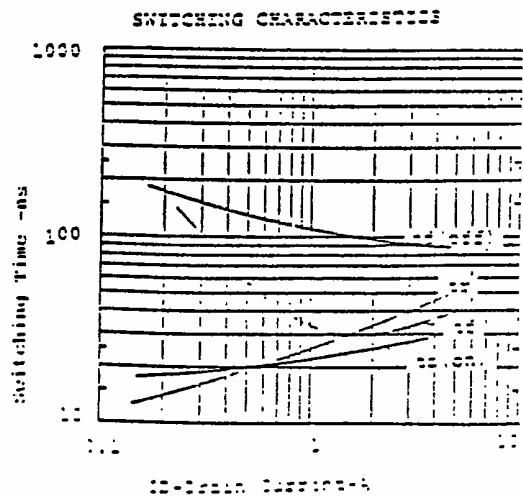
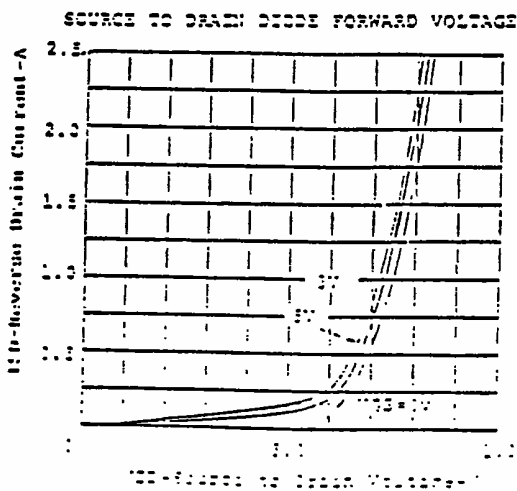
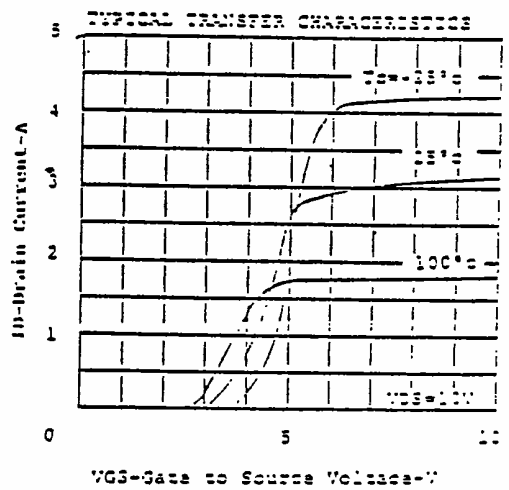
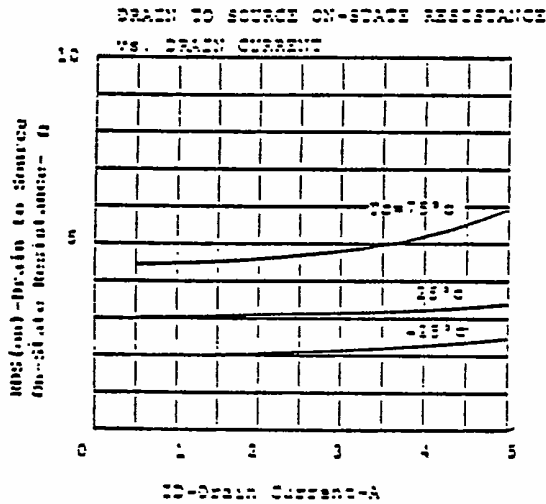
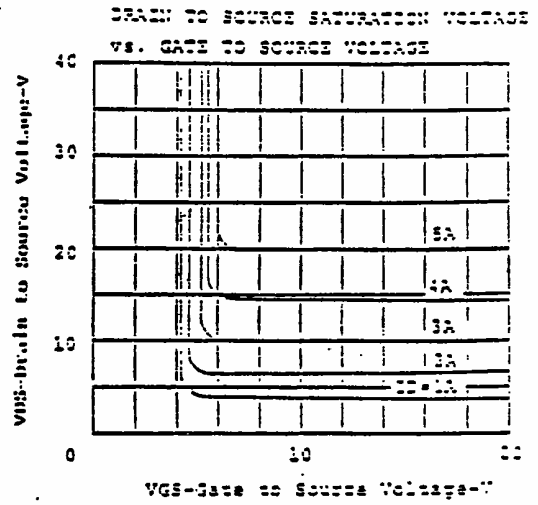
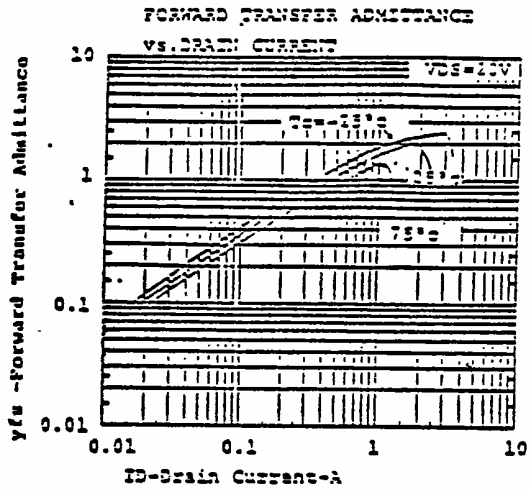

CAPACITANCE vs. DRAIN TO SOURCE VOLTAGE

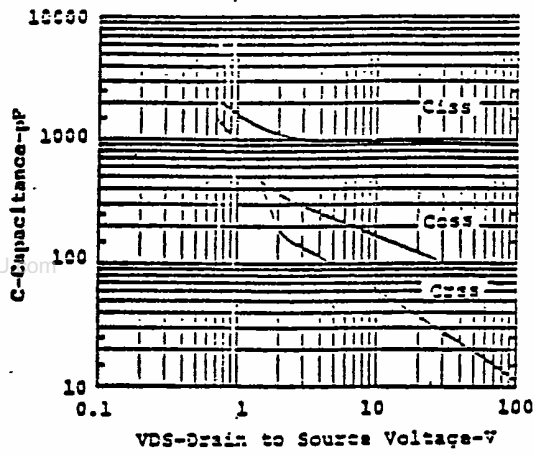

NEC Corporation

INTERNATIONAL ELECTRON DEVICES DIV.
 NEC Building, 33-1, Shiba Guchome
 Minato-ku, Tokyo 108, Japan
 Tel: Tokyo 454-1111
 Telex Address: NEC TOK J02666
 Cable Address: MICROPHONE TOKYO

3-7-73 1-1-73