

HORIZONTAL SIGNAL PROCESSING

The KA2135 is a monolithic integrated circuit designed for the horizontal signal processing circuit for CRT displays of television receivers, and monitors.

FUNCTIONS

- Polarity Switches
- X-Ray Protectors
- AFC
- Hori. OSC
- Pre Amp
- Pulse Width Adjustment

FEATURES

- Processing for both negative & positive SYNC signal
- Wide horizontal oscillation frequency range (14KHz ~ 60KHz)
- Wide output pulse width selection ($2\mu\text{s}$ ~ $40\mu\text{s}$)

BLOCK DIAGRAM

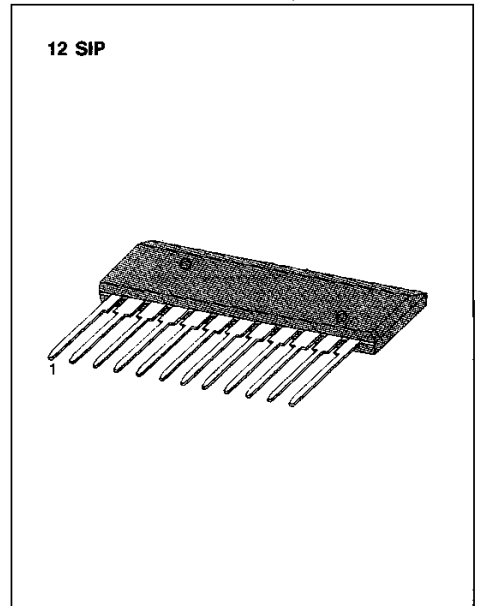
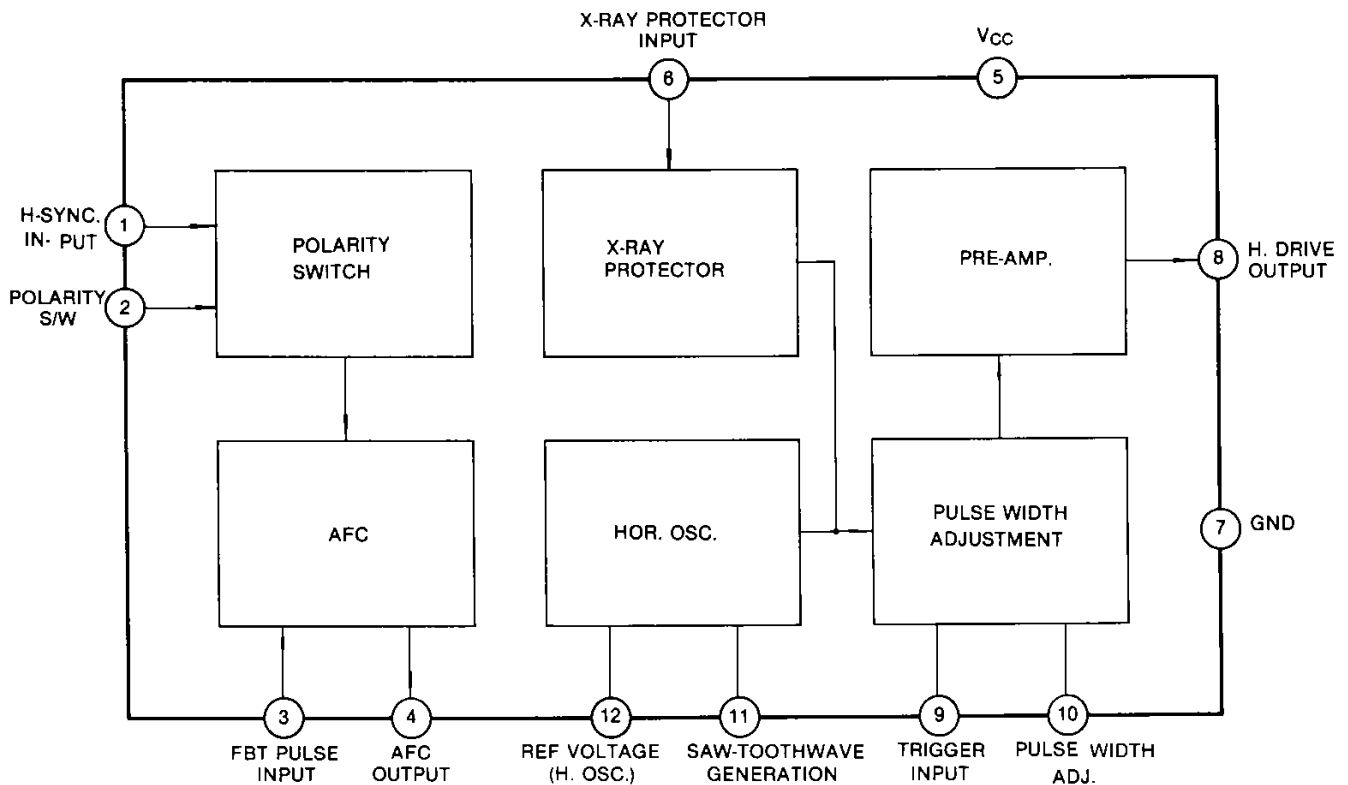

ORDERING INFORMATION

Device	Package	Operating Temperature
KA2135	12 SIP	- 20 ~ + 70°C

ABSOLUTE MAXIMUM RATINGS (Ta = 25°C)

Characteristic	Symbol	Value	Unit
Supply Voltage	V_{CC}	13.2	V
Supply current	I_{CC}	50	mA
Power Dissipation	P_D	1140	mW
Operating Temperature	T_{OPR}	-20 ~ +70	°C
Storage Temperature	T_{STG}	-40 ~ +150	°C

ELECTRICAL CHARACTERISTICS (Ta = 25°C)

Characteristic	Symbol	Test Circuit	Condition	Min	Typ	Max	Unit
Total Supply Current	I_{CC}		$V_{CC} = 11V$	30	45	60	mA
Polarity Switching Voltage 1	V_1	1	Positive Signal I_N	0		0.4	V
Polarity Switching Voltage 2	V_2	1	Negative Signal I_N			2.5	V
Hori. OSC Starting Voltage	$V_{OSC-S(H)}$	2	$f_{HO} = 12KHz \sim 19KHz$			7.5	V
Hori. OSC Frequency	$f_{HO(1)}$	2	$V_{CC} = 11V, C = 4400pF$	15.0	15.75	16.5	KHz
Hori. OSC Frequency Range	$f_{HO(2)}$	3	$V_{CC} = 11V, C = 820pF, 5600pF$	14		60	KHz
f_{HO} to Supply Voltage Ratio	$\Delta f_{HO}/V_{CC}$	2	$f_{HO} = 15.75KHz, f_{HO}/9.9V - f_{HO}/12.1V$		40	130	Hz
f_{HO} to Ambient Temperature Ratio	$\Delta f_{HO}/T_A$	2	$f_{HO} = 15.75KHz, f_{HO}/-20^\circ C - f_{HO}/60^\circ C$			260	Hz
OSC Frequency Control Sensitivity	S_{OSC}	4	$\Delta I_O = \pm 25\mu A$	16.0	17.6	19.3	Hz/ μA
D.C. Loop Gain	G_{DC}		$\mu \times S_{OSC}$		700		Hz/ μs
Output Pulse Width	$t_{HO(1)}$	5	$V_{CC} = 11V, R = 20K\Omega, C = 6800pF$	17.8	19.4	21.2	μs
Output Pulse Width Selection	$t_{HO(2)}$	5	$V_{CC} = 11V, R = 20K\Omega, C = 330pF, 18000pF$	2		40	μs
Output Pulse Width to Supply Voltage Ratio	$\Delta t_{HO}/V_{CC}$	5	$V_{CC} = 9.9V \sim 12.1V$			5	%
Output Pulse Width to Supply Temperature Ratio	$\Delta t_{HO}/T_A$	5	$V_{CC} = 11V, T_a = -20^\circ C \sim +60^\circ C$			5	%
OSC Output Saturation Voltage	V_8		$V_{CC} = 11V, V_{10.7} = 1V$			2.0	V
OSC Output Drive Current	V_8		$V_{CC} = 11V, V_{10.7} = 1V$	300			mA
X-Ray Protection Start Voltage	V_8	2	$V_{CC} = 11V$	0.5	0.64	0.75	V

TYPICAL APPLICATION CIRCUIT

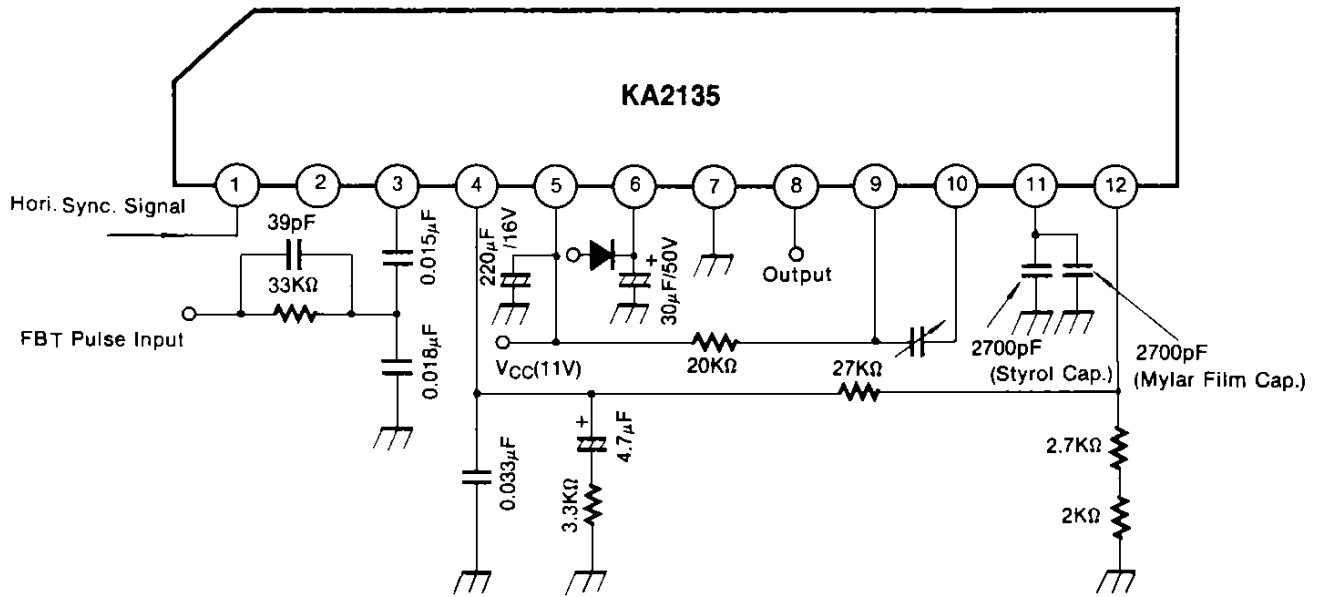

TEST CIRCUIT

Test Circuit 1 (V_{2,7})

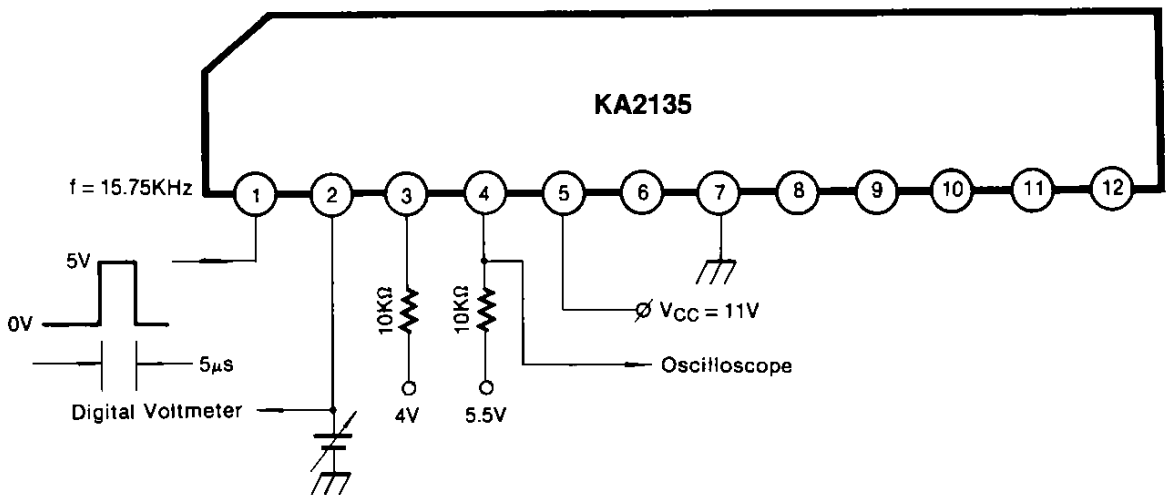

Test Circuit 2 (V_{OSC-S(H)}, f_{HO(1)}, f_{HO(2)}, Δf_{HO}/V_{CC}, Δf_{HO}/T_a, V_{6,7})

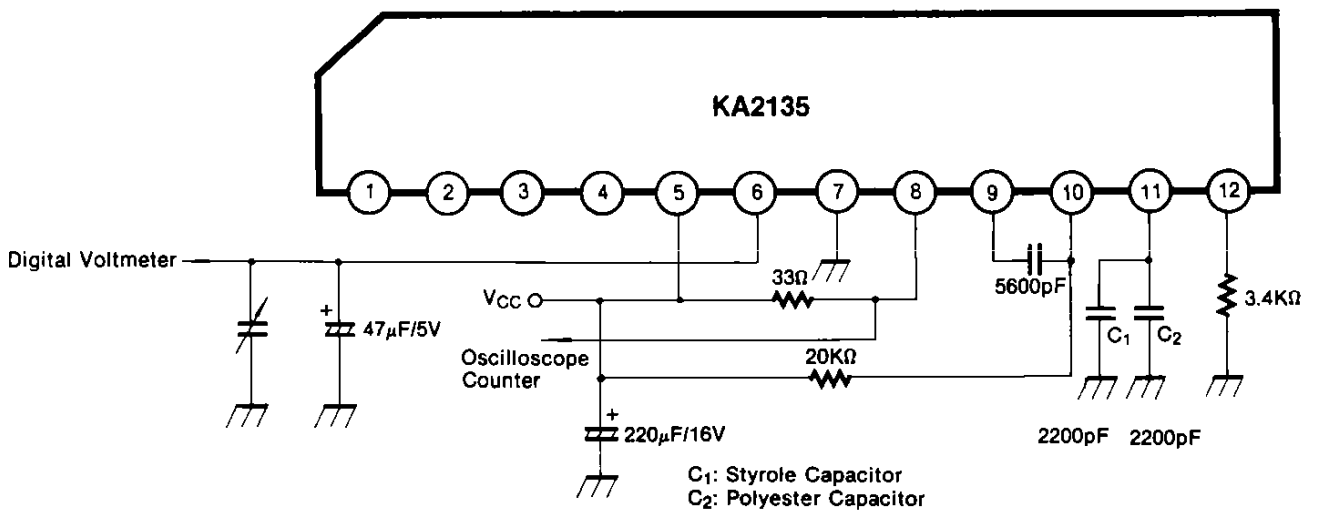

Test Circuit 3 ($f_{HO(2)}$)

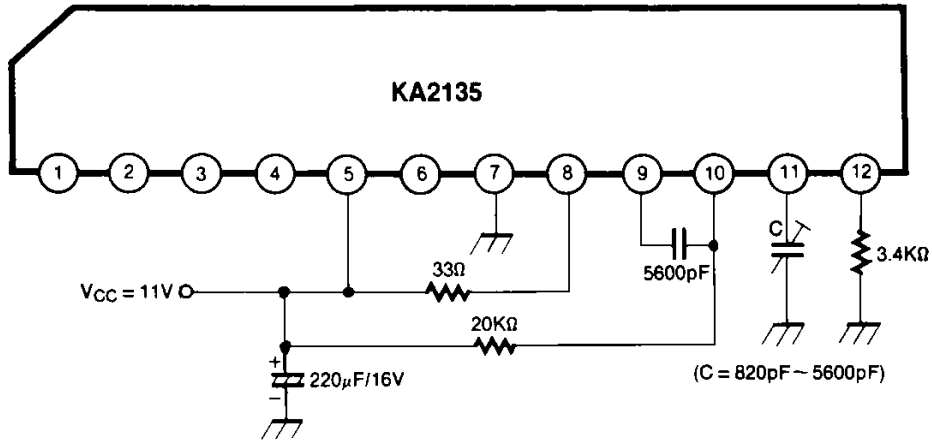

Test Circuit 4 (B)

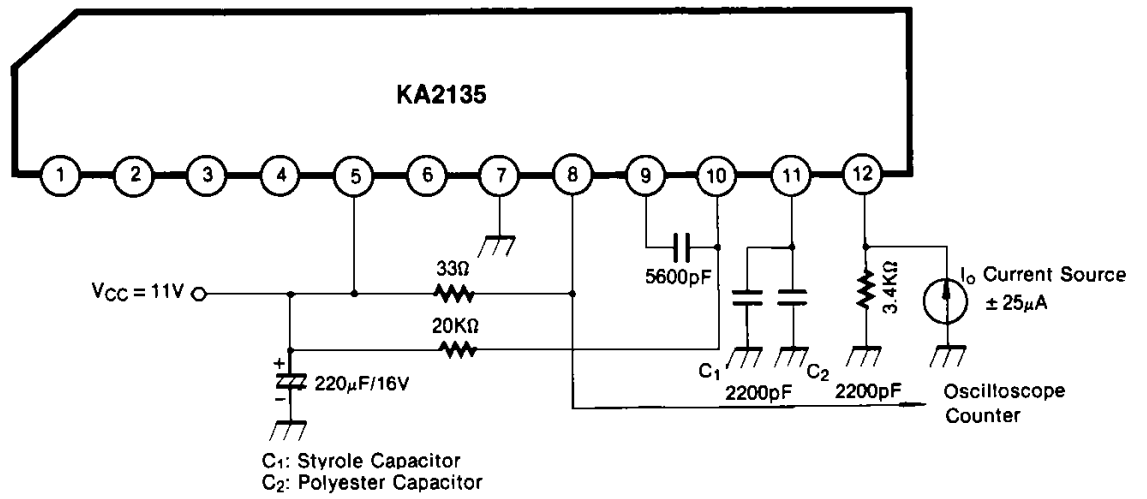

Test Circuit 5 ($\Delta V_{CC}/\Delta T_a$)

