

KA311

SINGLE COMPARATOR

VOLTAGE COMPARATOR

The KA311 series is a monolithic, low input current voltage comparator. This device is also designed to operate from dual or single supply voltage.

FEATURE

- Low input bias current : 250nA (Max)
- Low input offset current : 50nA (Max)
- Differential Input Voltage : $\pm 30V$.
- Power supply voltage : single 5.0V supply to $\pm 15V$.
- Offset voltage null capability.
- Strobe capability.

BLOCK DIAGRAM

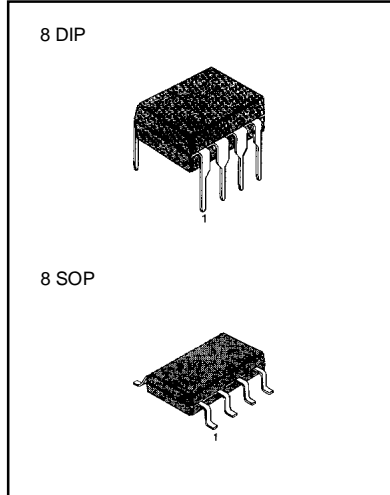
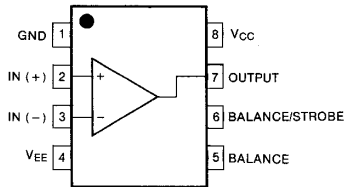

ORDERING INFORMATION

Device	Package	Operating Temperature
KA311	8 DIP	0 ~ +70 °C
KA311D	8 SOP	

SCHEMATIC DIAGRAM

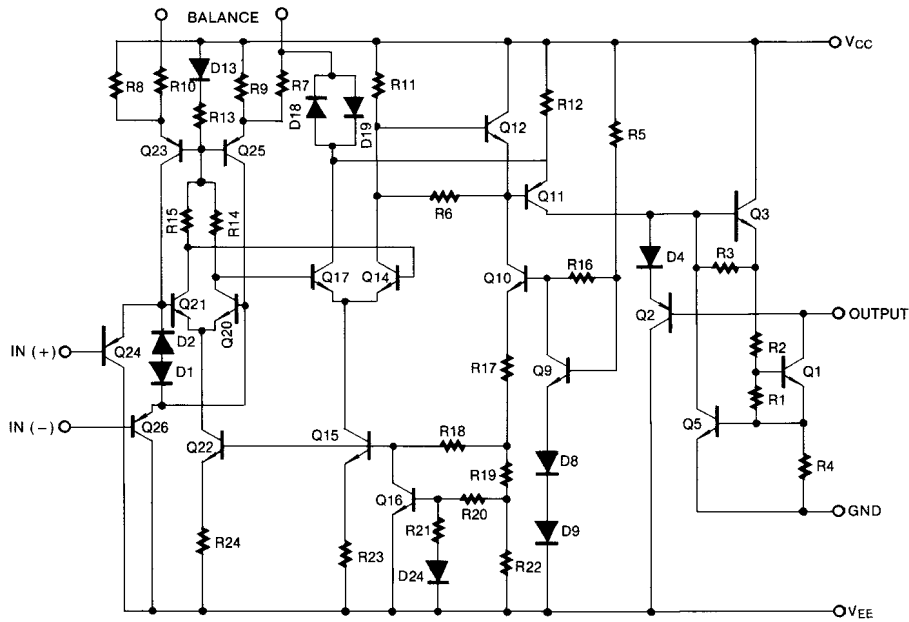

ABSOLUTE MAXIMUM RATINGS

Characteristic	Symbol	Value	Unit
Total Supply Voltage	V_{CC}	36	V
Output to Negative Supply Voltage KA311	$V_O - V_{EE}$	40	V
Ground to Negative voltage	V_{EE}	30	V
Differential Input Voltage	$V_{I(DIFF)}$	± 30	V
Input Voltage	V_I	± 15	V
Output Short Circuit Duration		10	sec
Power Dissipation	P_D	500	mW
Operating Temperature Range	T_{OPR}	0 ~ +70	°C
Storage Temperature Range	T_{STG}	- 65 ~ +150	°C

ELECTRICAL CHARACTERISTICS ($V_{CC} = 15V$, $T_A = 25^\circ C$, unless otherwise specified)

Characteristic	Symbol	Test Conditions	Min	Typ	Max	Unit
Input Offset Voltage	V_{IO}	$R_S \leq 50K\Omega$ NOTE 1		1.0	7.5	mV
					10	
Input Offset Current	I_{IO}	NOTE 1		6	50	nA
					70	
Input Bias Current	I_{BIAS}	NOTE 1		100	250	nA
					300	
Voltage Gain	G_V		40	200		V/mV
Response Time	t_{RES}	NOTE 2		200		nS
Saturation Voltage	V_{SAT}	$I_O = 50mA$, $V_I \leq -10mV$ $V_{CC} \geq 4.5V$, $V_{EE} = 0V$ $I_{SINK} = 8mA$, $V_I \geq -10mV$, NOTE 1		0.75	1.5	V
				0.23	0.4	
Strobe "NO" Current	$I_{STR(ON)}$			3		mA
Output Leakage Current	I_{SINK}	$I_{STR} = 3mA$, $V_I \geq 10mV$ $V_{O(P)} = 35V$, $V_{EE} = V_{GND} = -5V$		0.2	50	nA
Input Voltage Range	$V_{I(R)}$	NOTE 1	-14.5 to 13.0	-14.7 to 13.8		V
Positive Supply Current	I_{CC}			3.0	7.5	mA
Negative Supply Current	I_{EE}			-2.2	-5.0	mA
Strobe Current	I_{STR}			3		mA

NOTE 1. $0 \geq T_A \geq +70^\circ C$

2. The response time specified is for a 100mV input step with 5mV over drive.

TYPICAL PERFORMANCE CHARACTERISTICS

Fig. 1 INPUT BIAS CURRENT

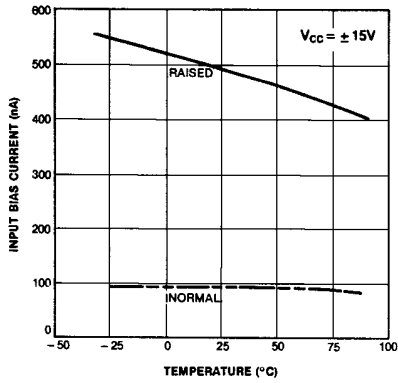

Fig. 2 INPUT OFFSET CURRENT

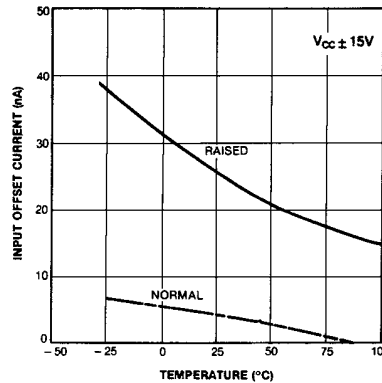

Fig. 3 OFFSET VOLTAGE VS INPUT RESISTANCE

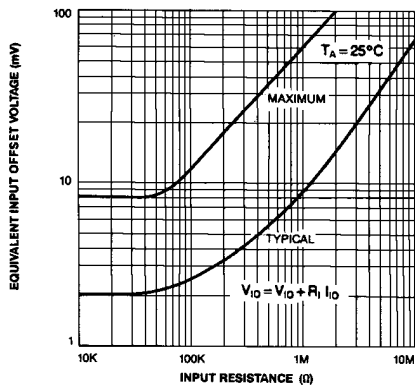

Fig. 4 INPUT BIAS CURRENT VS DIFFERENTIAL

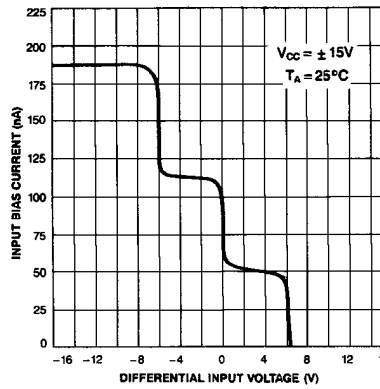

Fig. 5 COMMON MODE LIMITS VS TEMPERATURE

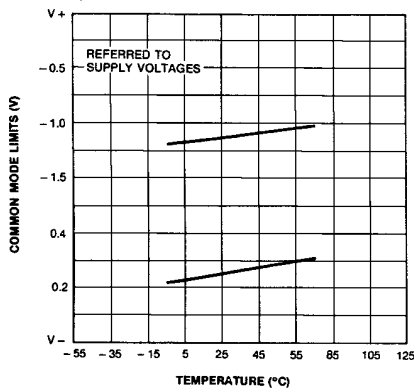

Fig. 6 OUTPUT VOLTAGE VS DIFFERENTIAL

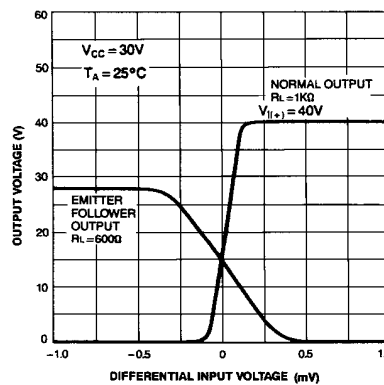

Fig. 7 SATURATION VOLTAGE VS CURRENT

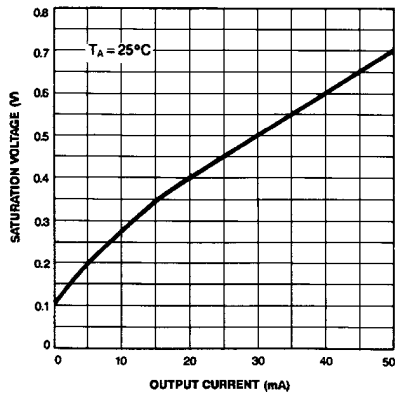

Fig. 8 SUPPLY CURRENT VS TEMPERATURE

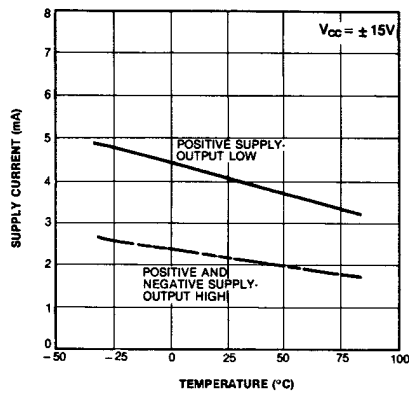

Fig. 9 LEAKAGE CURRENTS VS TEMPERATURE

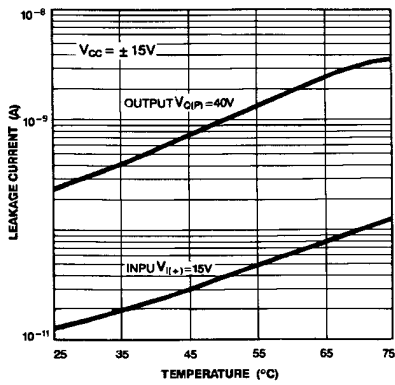

Fig. 10 SUPPLY CURRENT VS SUPPLY VOLTAGE

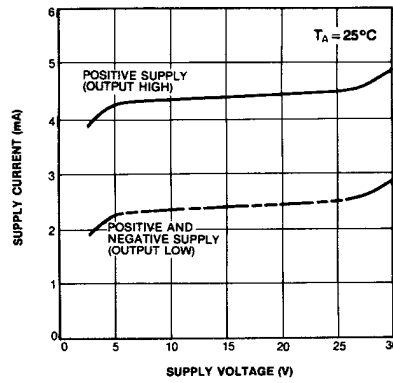

Fig. 11 OUTPUT SATURATION VOLTAGE

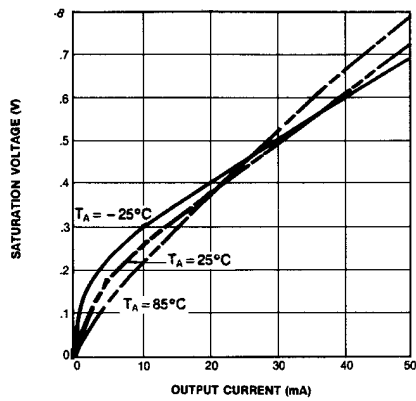

Fig. 12 OUTPUT LIMITING CHARACTERISTICS

