

KA3S0680RF

SAMSUNG POWER SWITCH

FEATURES

- Wide operating frequency range up to 150KHz
- Pulse by pulse over current limiting
- Over load protection
- Over voltage protection (min:23V)
- Internal thermal shutdown function
- Under voltage lockout
- Internal high voltage sense FET
- External sync terminal
- Auto Restart

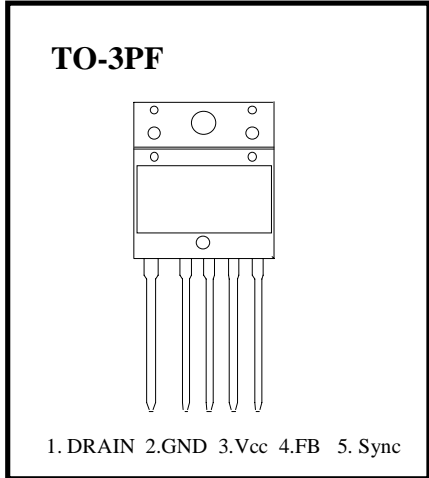

PRODUCT SUMMARY

Part Number	BVdss	Rds(on)	ID
KA3S0680RF	800V	2Ω	6A

BLOCK DIAGRAM

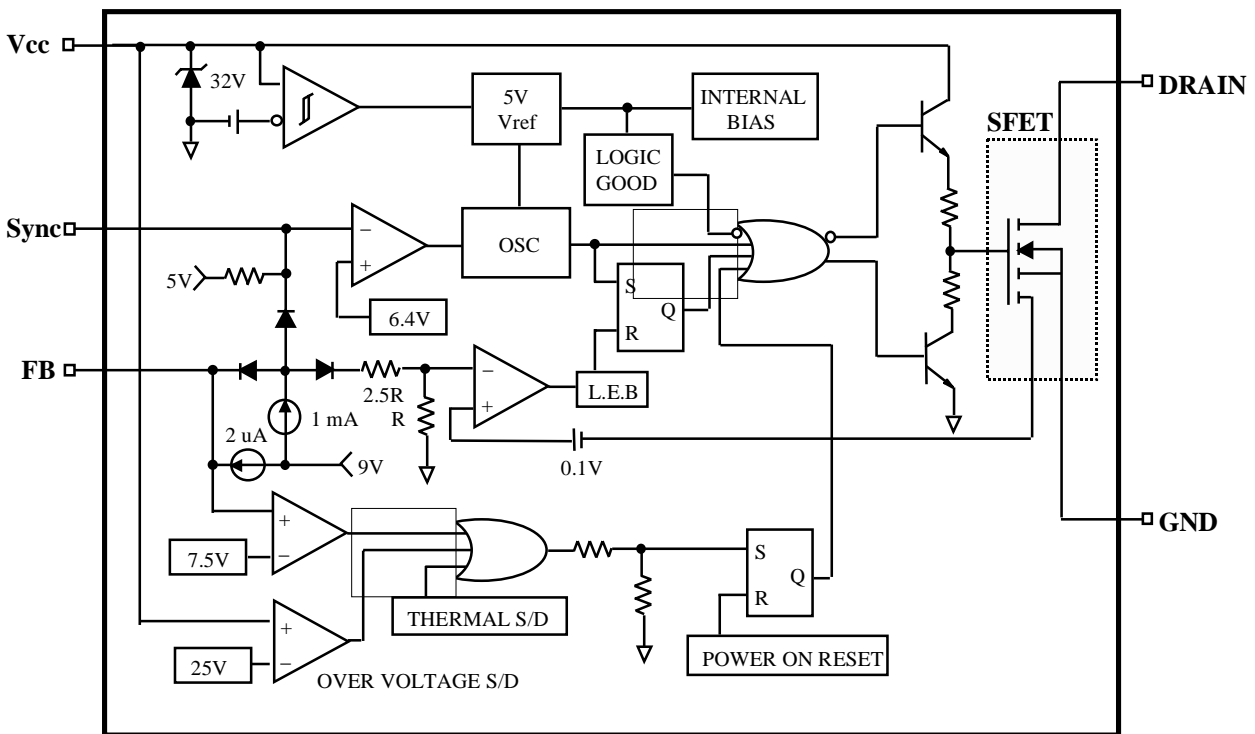

ABSOLUTE MAXIMUM RATINGS

Characteristic	Symbol	Value	Unit
Drain - Source(GND) Voltage (1)	V _{DSS}	800	V
Drain - Gate Voltage (R _{GS} = 1MΩ)	V _{DGR}	800	V
Gate - Source(GND) Voltage	V _{GS}	±30	V
Drain Current Pulsed (2)	I _{DM}	24.0	A _{DC}
Single Pulsed Avalanche Energy (3)	E _{AS}	455	mJ
Avalanche Current	I _{AS}	-	A
Continuous Drain Current (T _c = 25 °C)	I _D	6.0	A _{DC}
Continuous Drain Current (T _c = 100 °C)	I _D	4.0	A _{DC}
Supply Voltage	V _{CC}	30	V
Analog Input Voltage Range	V _{FB}	-0.3 ~ V _{SD}	V
Total Power Dissipation	P _D (wt H/S)	150	W
	Derating	1.21	W/°C
Operating Temperature	T _{OPR}	- 25 ~ + 85	°C
Storage Temperature	T _{STG}	- 55 ~ + 150	°C

Notes: (1) T_J = 25 °C to 150 °C

(2) Repetitive rating : Pulse width limited by maximum junction temperature

(3) L = 24mH, V_{DD} = 50V, R_G = 25Ω, starting T_j = 25 °C

ELECTRICAL CHARACTERISTICS (SFET part)

(Ta = 25 °C unless otherwise specified)

Symbol	Characteristic	Min	Typ	Max	Units	Test Conditions
BV _{DSS}	Drain-Source Breakdown Voltage	800	-	-	V	V _{GS} =0V, I _D =50uA
I _{DSS}	Zero Gate Voltage Drain Current	-	-	50	uA	V _{DS} =Max, Rating, V _{GS} =0V
		-	-	200	uA	V _{DS} =0.8Max, Rating, V _{GS} =0V TC=125 °C
R _{DS(on)}	Static Drain-Source On Resistance(4)	-	1.6	2.0	Ω	V _{GS} = 10V, I _D = 4.0A

ELECTRICAL CHARACTERISTICS (SFET part continued)

(Ta = 25 °C unless otherwise specified)

Symbol	Characteristic	Min	Typ	Max	Units	Test Conditions
g_{fs}	Forward Transconductance(4)	1.5	2.5	-	mho	$V_{DS}=15V, I_D=4.0A$
C_{iss}	Input Capacitance	-	1600	-	pF	$V_{GS} = 0V, V_{DS} = 25V,$ $f = 1MHz$
C_{oss}	Output Capacitance	-	140	-		
C_{rss}	Reverse Transfer Capacitance	-	42	-		
$t_{d(on)}$	Turn On Delay Time	-	60	-	nS	$V_{DD} = 0.5BV_{DSS}, I_D = 6.0A$ (MOSFET switching time are essentially independent of operating temperature)
t_r	Rise Time	-	150	-		
$t_{d(off)}$	Turn Off Delay Time	-	300	-		
t_f	Fall Time	-	130	-		
Q_g	Total Gate Charge (Gate-Source + Gate-Drain)	-	70	-	nC	$V_{GS} = 10V, I_D = 6.0A$ $V_{DS} = 0.5BV_{DSS}$ (MOSFET switching time are essentially independent of operating temperature)
Q_{gs}	Gate-Source Charge	-	16	-		
Q_{gd}	Gate-Drain(Miller) Charge	-	27	-		

Notes: (1) $T_J = 25^\circ C$ to $150^\circ C$

(2) Repetitive rating : Pulse width limited by maximum junction temperature

(3) $L = 24mH, V_{DD} = 50V, R_G = 25\Omega,$ starting $T_j = 25^\circ C$ (4) Pulse Test : Pulse width $\leq 300\mu s,$ Duty Cycle $\leq 2\%$

ELECTRICAL CHARACTERISTICS (Control part)

(Ta = 25°C unless otherwise specified)

Symbol	Characteristics	Min	Typ	Max	Unit	Test Conditions
REFERENCE SECTION						
Vref	Output Voltage (Note 1)	4.80	5.00	5.20	V	Ta = 25°C
Vref/ ΔT	Temperature Stability (Note 1&2)	-	0.3	0.6	mV/°C	-25°C ≤ Ta ≤ +85°C
OSCILLATOR SECTION						
FOSC	Initial Accuracy	18	20	22	KHz	Ta = 25°C
ΔF / ΔT	Frequency Change with Temperature (Note 2)		±5	±10	%	-25°C ≤ Ta ≤ +85°C
VSYTH	Sync Threshold Voltage	6.0	6.4	6.8	V	Vfb = 5 V
FEEDBACK SECTION						
DMAX	Maximum Duty Cycle	92	95	98	%	
OVER CURRENT PROTECTION SECTION						
IL(MAX)	Over Current Protection	3.52	4.00	4.48	A	Max. Inductor Current
UVLO SECTION						
Vth(H)	Start Threshold Voltage	14	15	16	V	
Vth(L)	Minimum Operating Voltage	9	10	11	V	After turn on

ELECTRICAL CHARACTERISTICS (Continued)

(Ta = 25 °C unless otherwise specified)

Symbol	Characteristics	Min	Typ	Max	Unit	Test Conditions
TOTAL STANDBY CURRENT SECTION						
I _{ST}	Start up Current	0.1	0.3	0.55	mA	V _{CC} = 14V
I _{OPR}	Operating Supply Current (control part only)	6	12	18	mA	Ta = 25 °C ,
V _Z	V _{CC} Zener Voltage	30	32.5	35	V	I _{CC} = 20mA
SHUTDOWN SECTION						
V _{SD}	Shutdown Feedback Voltage	6.9	7.5	8.1	V	
T _{SD}	ThermalShutdownTemperature(T _j)	140	160	-	°C	(Note 1)
V _{ovp}	Over Voltage Protection	23	25	28		
SOFT START SECTION						
I _{SS}	Soft Start Current	0.8	1.0	1.2	mA	Sync&S/S = GND
V _{SS}	Soft Start Voltage	4.7	5.0	5.3	V	V _{FB} = 2V

- Notes:** (1) These parameters, although guaranteed, are not 100% tested in production
(2) These parameters, although guaranteed, are tested in EDS(wafer test) process.

TYPICAL PERFORMANCE CHARACTERISTICS

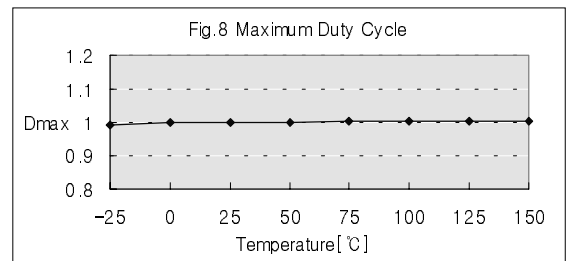
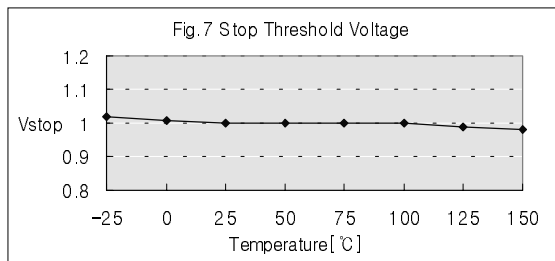
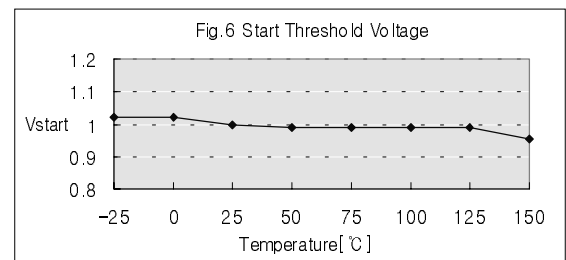
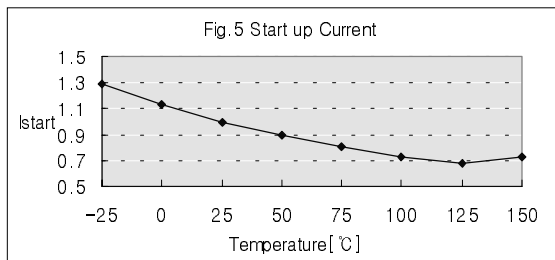
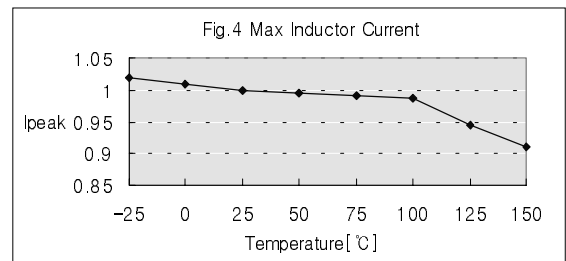
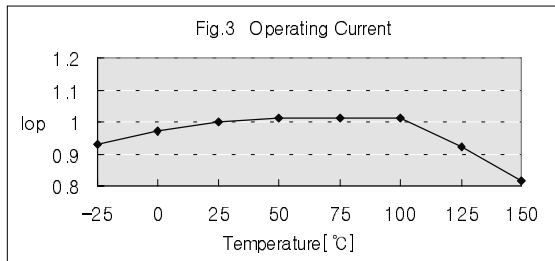
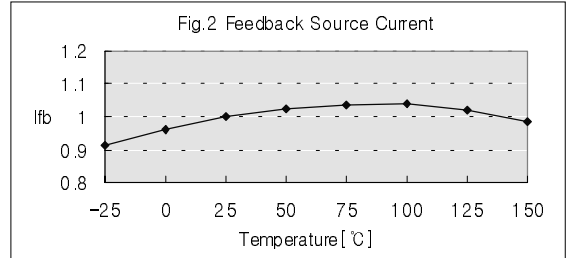
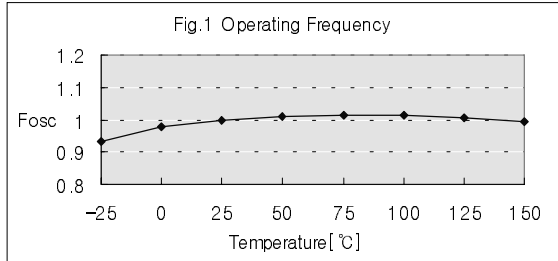

TYPICAL PERFORMANCE CHARACTERISTICS (Continued)

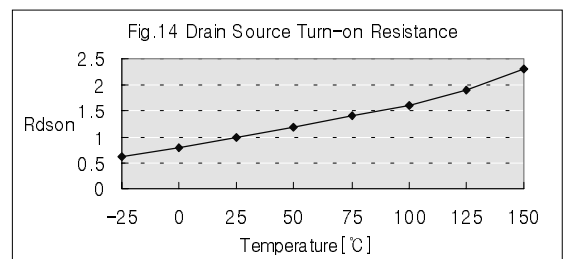
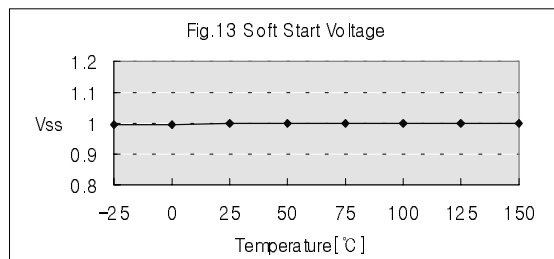
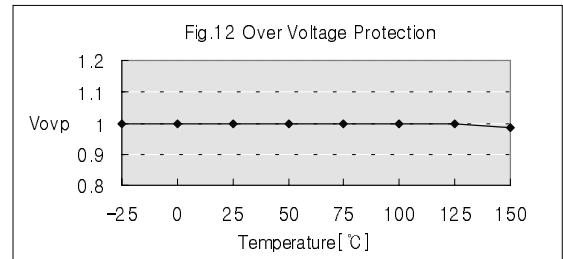
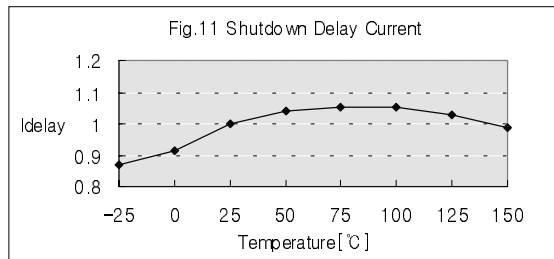
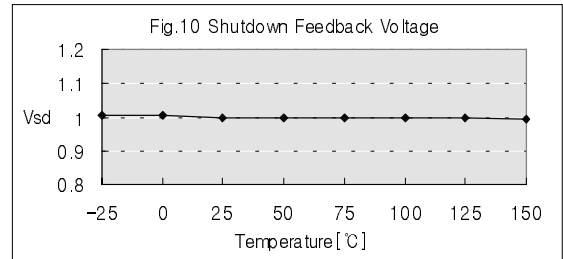
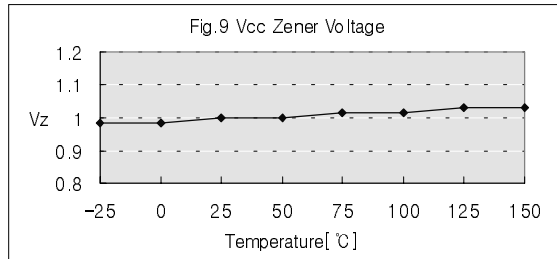

TO-3PF

Dimensions in Millimeters

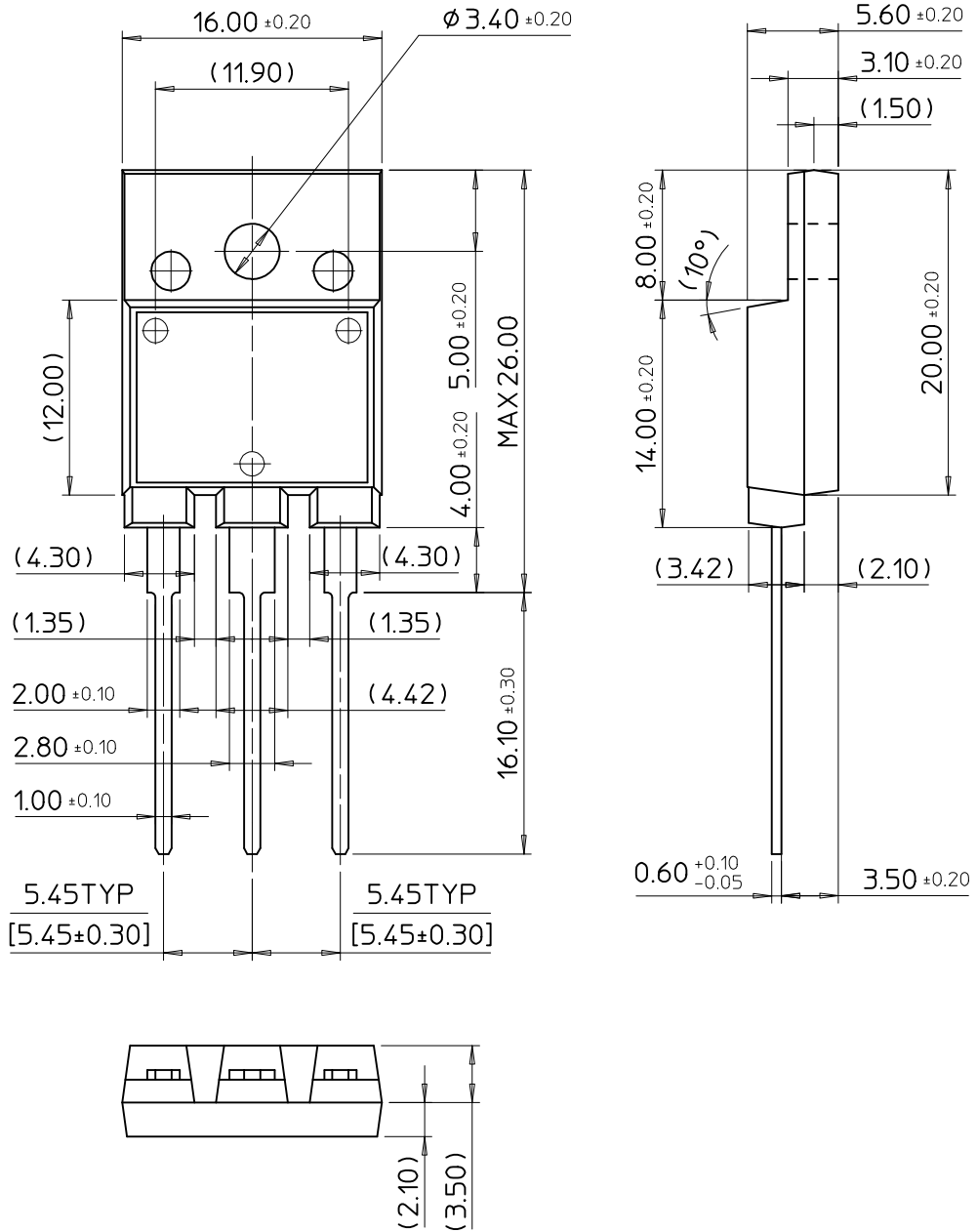

SAMSUNG ELECTRONICS CO.,LTD.