

SAMSUNG POWER SWITCH

The SPS product family is specially designed for an off line SMPS with minimal external component. The SPS consist of high voltage Power SenseFET and current mode control IC. Included control IC features a tr-
 - trimmed oscillator, under voltage lock out, leading edge blanking, optimized gate driver, and temperature compensated current sources.
 Also included are various protective functions, thermal shutdown, Over-voltage protection, Overcurrent protection, and overload protection. Compared with RCC or control IC and MOSFET solution, SPS can reduce total number of components, design size, weight. For this reason SPS can increase efficiency, productivity and system reliability. It has a basic platform well suited for cost effective C-TV power supply.

FEATURES

- Wide operating frequency range up to 150KHz
- Pulse by pulse over current limiting
- Over load protection
- Over voltage protection (min:23V)
- Internal thermal shutdown function
- Under voltage lockout
- Internal high voltage sense FET
- External sync terminal
- Auto Restart Mode

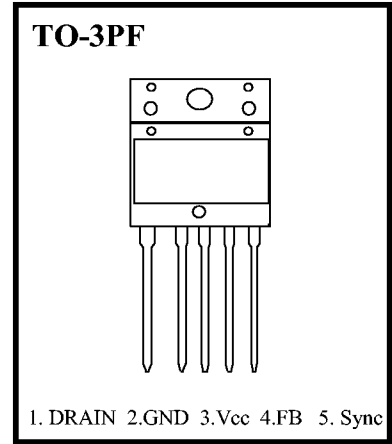

ORDERING INFORMATION

Device	Package	Rating	Topr (°C)
KA3S0765RF	TO3PF-5L	650V, 7A	-20 ~ +80

BLOCK DIAGRAM

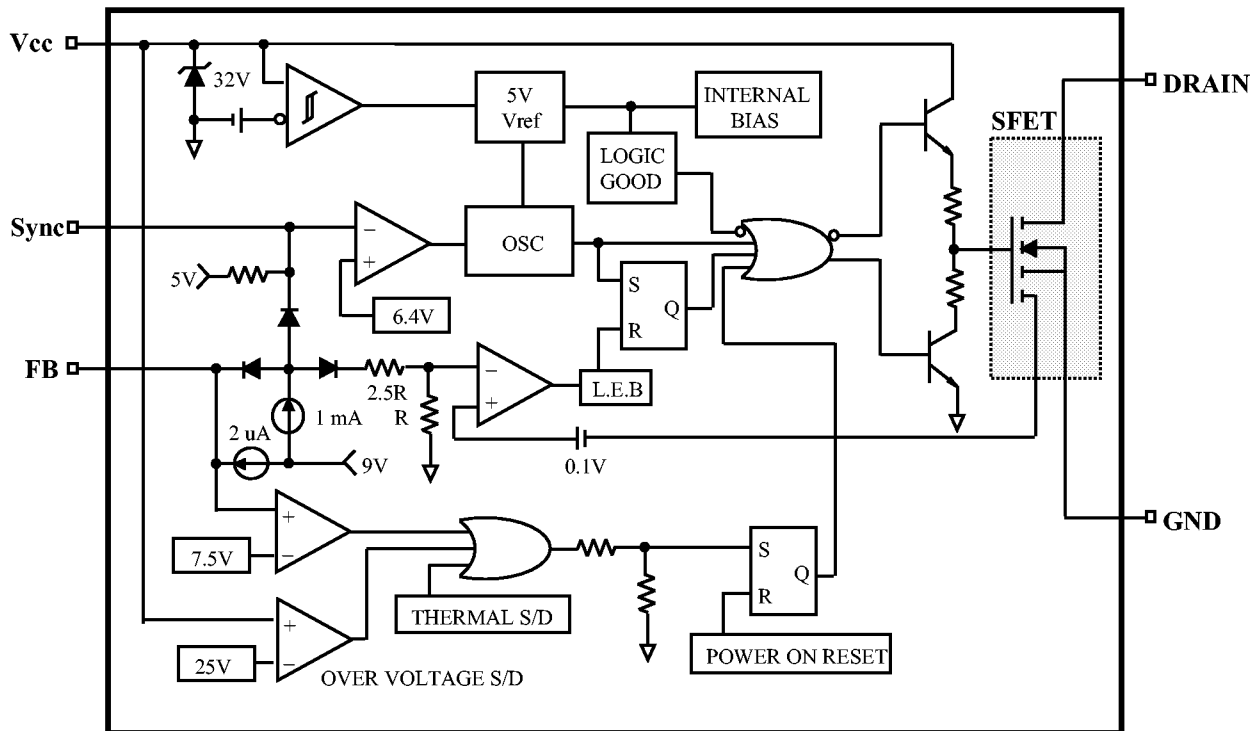

ABSOLUTE MAXIMUM RATINGS

Characteristic	Symbol	Value	Unit
Drain - Source(GND) Voltage (1)	V _{DSS}	650	V
Drain - Gate Voltage (R _{GS} = 1M Ω)	V _{DGR}	650	V
Gate - Source(GND) Voltage	V _{GS}	± 30	V
Drain Current Pulsed (2)	I _{DM}	28.0	ADC
Single Pulsed Avalanche Energy (3)	E _{AS}	570	mJ
Avalanche Current	I _{AS}	-	A
Continuous Drain Current (T _c = 25 $^{\circ}$ C)	I _D	7.0	ADC
Continuous Drain Current (T _c = 100 $^{\circ}$ C)	I _D	5.6	ADC
Supply Voltage	V _{CC}	30	V
Analog Input Voltage Range	V _{FB}	-0.3 ~ V _{SD}	V
Total Power Dissipation	P _D (wt H/S)	140	W
	Derating	1.11	W/ $^{\circ}$ C
Operating Temperature	T _{OPR}	- 25 ~ + 85	$^{\circ}$ C
Storage Temperature	T _{STG}	- 55 ~ + 150	$^{\circ}$ C

Notes: (1) T_J = 25 $^{\circ}$ C to 150 $^{\circ}$ C

(2) Repetitive rating : Pulse width limited by maximum junction temperature

(3) L = 24mH, V_{DD} = 50V, R_G = 25 Ω , starting T_j = 25 $^{\circ}$ C

ELECTRICAL CHARACTERISTICS (SFET part)

(T_a = 25 $^{\circ}$ C unless otherwise specified)

Symbol	Characteristic	Min	Typ	Max	Units	Test Conditions
BV _{DSS}	Drain-Source Breakdown Voltage	650	-	-	V	V _{GS} =0V, I _D =50uA
I _{DSS}	Zero Gate Voltage Drain Current	-	-	50	uA	V _{DS} =Max, Rating, V _{GS} =0V
		-	-	200	uA	V _{DS} =0.8Max, Rating, V _{GS} =0V TC=125 $^{\circ}$ C
R _{DS(on)}	Static Drain-Source On Resistance(4)	-	1.25	1.6	Ω	V _{GS} = 10V, I _D = 4.0A

ELECTRICAL CHARACTERISTICS (SFET part continued)

(Ta = 25 °C unless otherwise specified)

Symbol	Characteristic	Min	Typ	Max	Units	Test Conditions
gfs	Forward Transconductance(4)	3.0	-	-	mho	V _{DS} =15V, I _D =4.0A
C _{iss}	Input Capacitance	-	1600	-	pF	V _{GS} = 0V, V _{DS} = 25V, f = 1MHz
C _{oss}	Output Capacitance	-	310	-		
C _{rss}	Reverse Transfer Capacitance	-	120	-		
td(on)	Turn On Delay Time	-	25	-	nS	V _{DD} = 0.5BV _{DSS} , I _D = 7.0A (MOSFET switching time are essentially independent of operating temperature)
tr	Rise Time	-	55	-		
td(off)	Turn Off Delay Time	-	80	-		
tf	Fall Time	-	50	-		
Qg	Total Gate Charge (Gate-Source + Gate-Drain)	-	-	72	nC	V _{GS} = 10V, I _D = 7.0A V _{DS} = 0.5BV _{DSS} (MOSFET switching time are essentially independent of operating temperature)
Qgs	Gate-Source Charge	-	9.3	-		
Qgd	Gate-Drain(Miller) Charge	-	29.3	-		

Notes: (1) T_J = 25 °C to 150 °C

(2) Repetitive rating : Pulse width limited by maximum junction temperature

(3) L = 24mH, V_{DD} = 50V, R_G = 25 Ω, starting T_j = 25 °C

(4) Pulse Test : Pulse width ≤ 300uS, Duty Cycle ≤ 2 %

ELECTRICAL CHARACTERISTICS (Control part)

(Ta = 25°C unless otherwise specified)

Symbol	Characteristics	Min	Typ	Max	Unit	Test Conditions
REFERENCE SECTION						
Vref	Output Voltage (Note 1)	4.80	5.00	5.20	V	Ta = 25°C
Vref/ ΔT	Temperature Stability (Note 1&2)	-	0.3	0.6	mV/°C	-25°C ≤ Ta ≤ +85°C
OSCILLATOR SECTION						
FOSC	Initial Accuracy	18	20	22	KHz	Ta = 25°C
ΔF / ΔT	Frequency Change with Temperature (Note 2)		±5	±10	%	-25°C ≤ Ta ≤ +85°C
VSYTH	Sync Threshold Voltage	6.0	6.4	6.8	V	Vfb = 5 V
FEEDBACK SECTION						
DMAX	Maximum Duty Cycle	92	95	98	%	
FEEDBACK SECTION						
IFB	Feedback Source Current	0.7	0.9	1.1	mA	Ta = 25°C, Vfb = GND
Idelay	Shutdown Delay Current	1.4	1.8	2.2	uA	Ta = 25°C, 5 V ≤ Vfb ≤ VSD
OVER CURRENT PROTECTION SECTION						
IL(MAX)	Over Current Protection	4.4	5.00	5.6	A	Max. Inductor Current
UVLO SECTION						
Vth(H)	Start Threshold Voltage	14	15	16	V	
Vth(L)	Minimum Operating Voltage	9	10	11	V	After turn on

ELECTRICAL CHARACTERISTICS (Continued)

(Ta = 25 °C unless otherwise specified)

Symbol	Characteristics	Min	Typ	Max	Unit	Test Conditions
TOTAL STANDBY CURRENT SECTION						
I _{ST}	Start up Current	0.1	0.3	0.55	mA	V _{CC} = 14V
I _{OPR}	Operating Supply Current (control part only)	6	12	18	mA	Ta = 25 °C,
V _Z	V _{CC} Zener Voltage	30	32.5	35	V	I _{CC} = 20mA
SHUTDOWN SECTION						
V _{SD}	Shutdown Feedback Voltage	6.9	7.5	8.1	V	
T _{SD}	Thermal Shutdown Temperature(T _j)	140	160	-	°C	(Note 1)
V _{ovp}	Over Voltage Protection	23	25	28		
SOFT START SECTION						
I _{SS}	Soft Start Current	0.8	1.0	1.2	mA	Sync&S/S = GND
V _{SS}	Soft Start Voltage	4.7	5.0	5.3	V	V _{FB} = 2V

- Notes:** (1) These parameters, although guaranteed, are not 100% tested in production
(2) These parameters, although guaranteed, are tested in EDS(wafer test) process.
(3) The amplitude of the sync. pulse is recommended to be between 2V and 3V for stable sync. function.

TYPICAL PERFORMANCE CHARACTERISTICS

(These characteristic graphs are normalized at $T_a = 25^\circ\text{C}$)

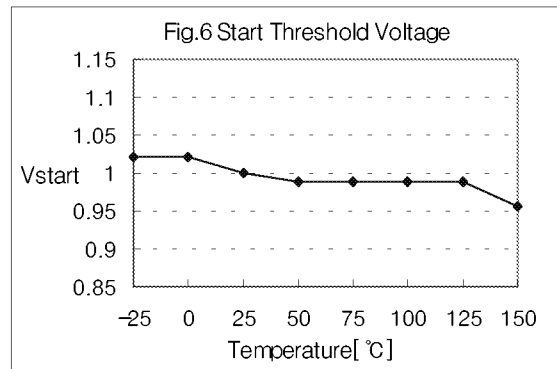
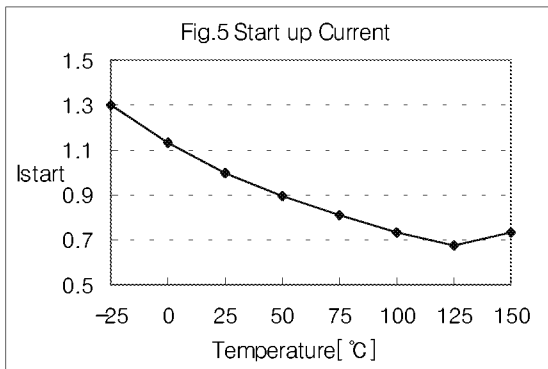
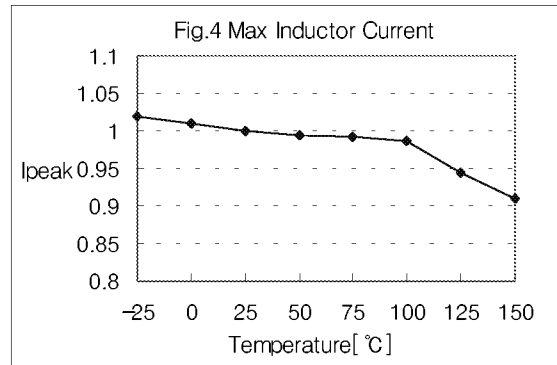
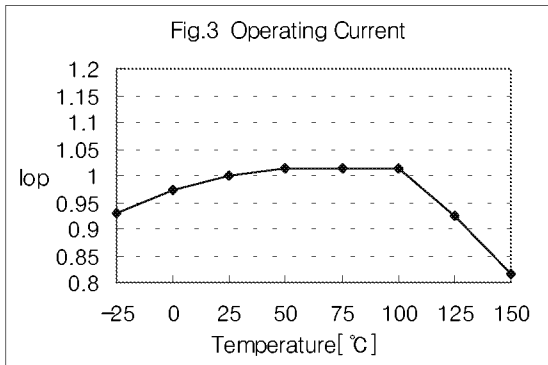
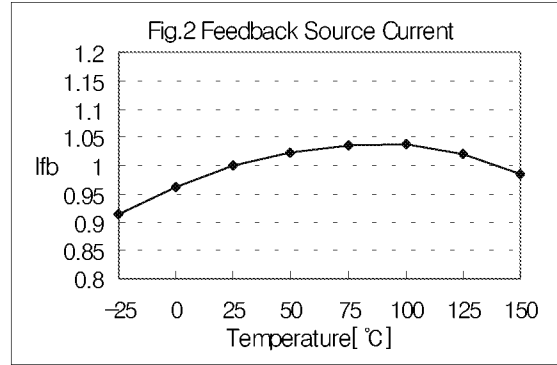
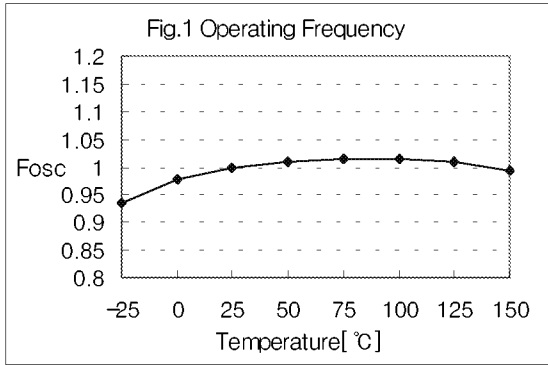

TYPICAL PERFORMANCE CHARACTERISTICS (Continued)

(These characteristic graphs are normalized at $T_a = 25^\circ\text{C}$)

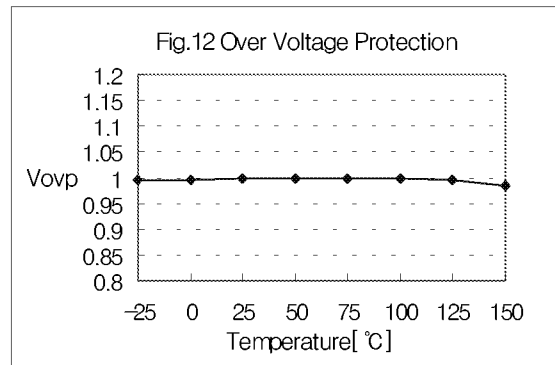
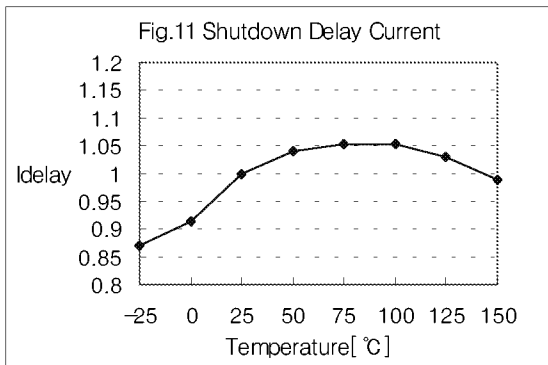
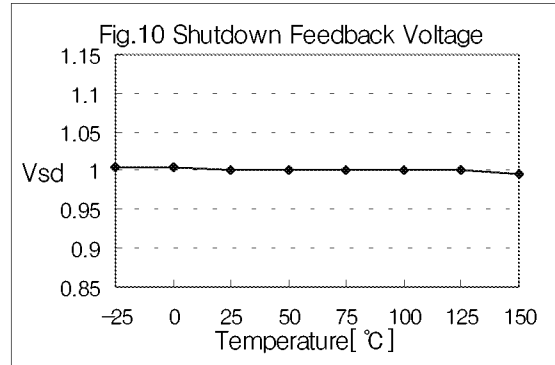
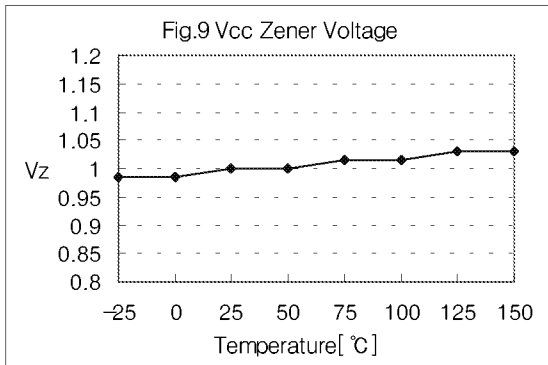
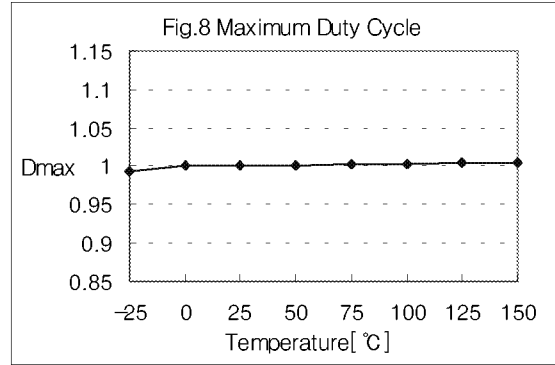
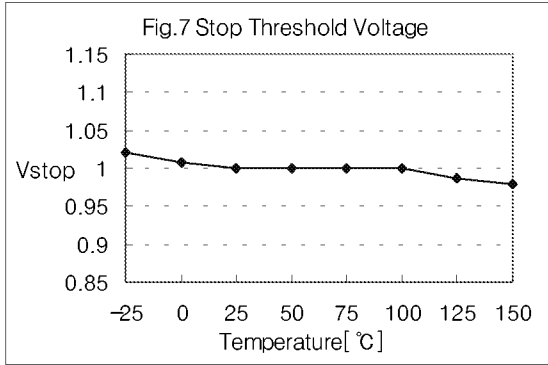

TYPICAL PERFORMANCE CHARACTERISTICS (Continued)

(These characteristic graphs are normalized at $T_a = 25^\circ\text{C}$)

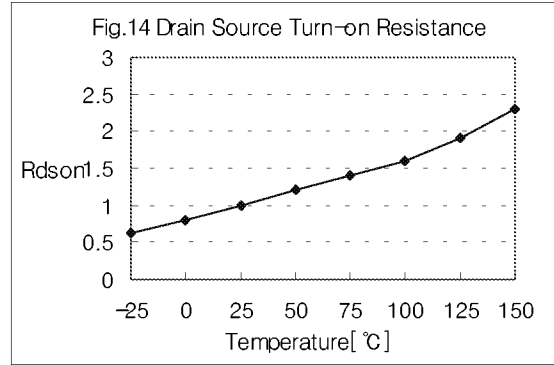
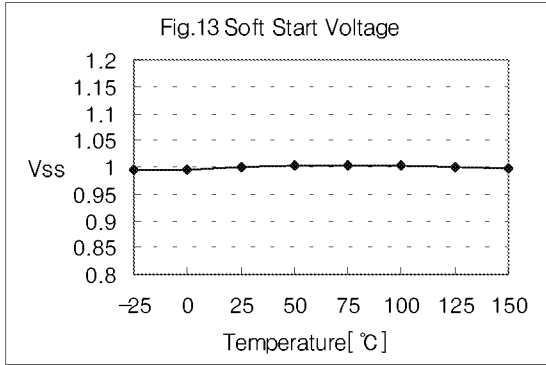

TO-3P (2)

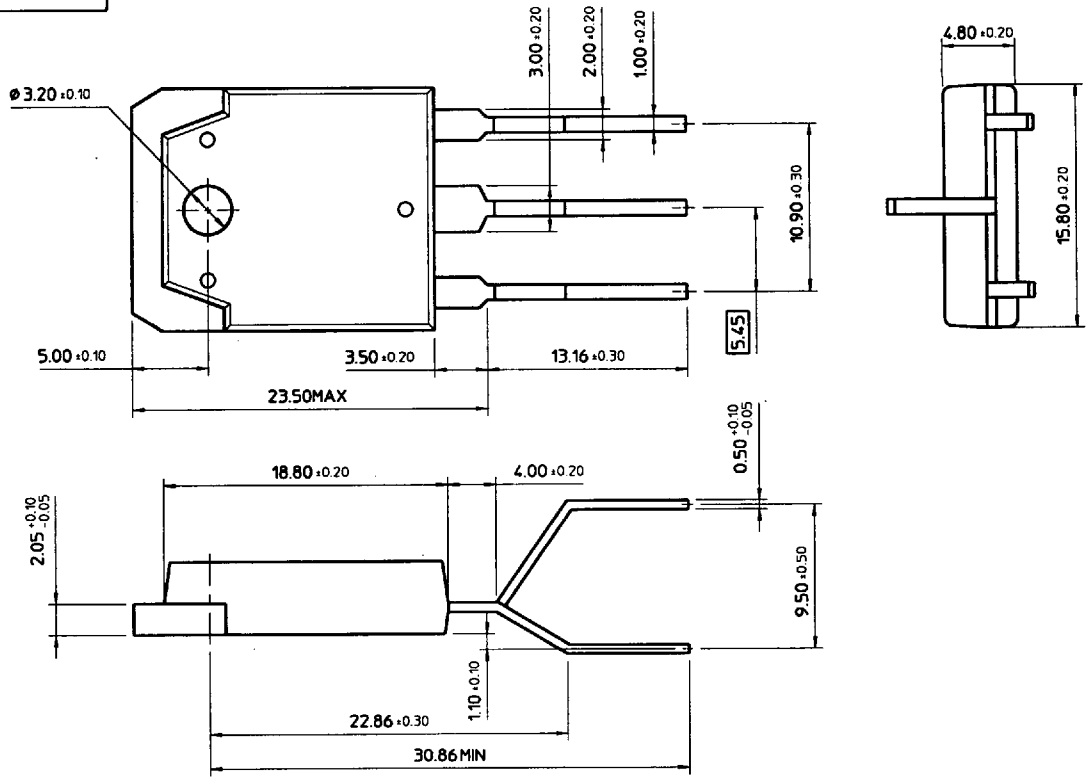

TO-3PF (1)

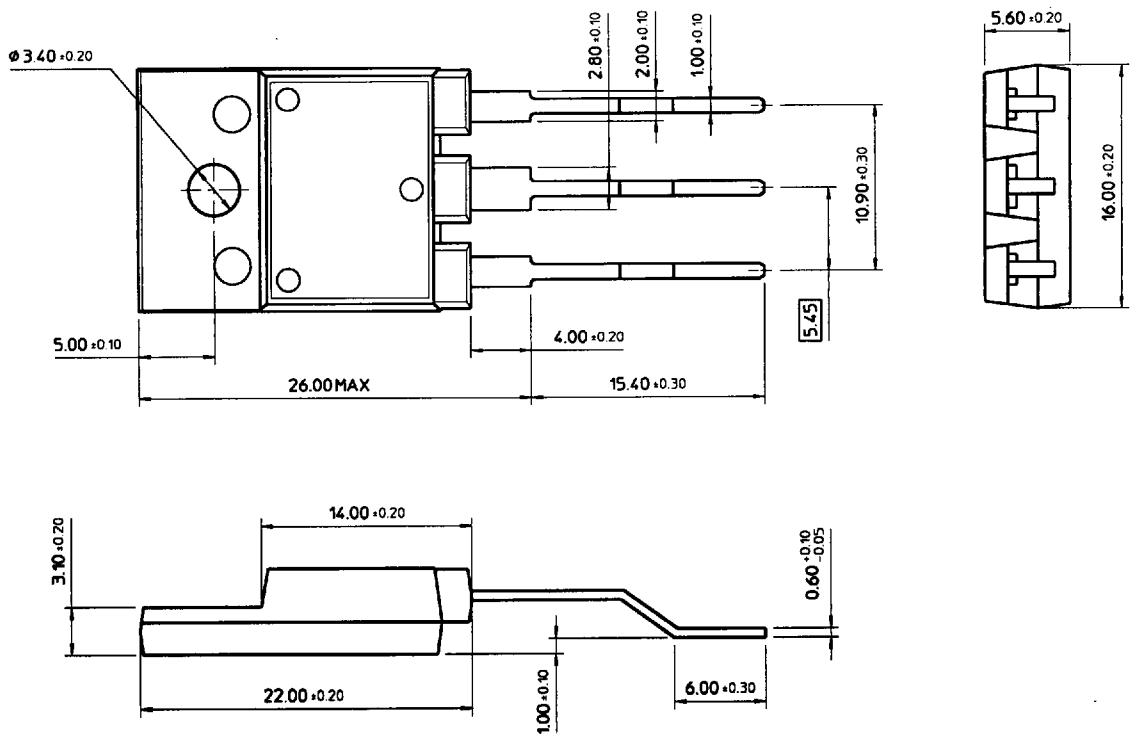

T0-3PF (2)

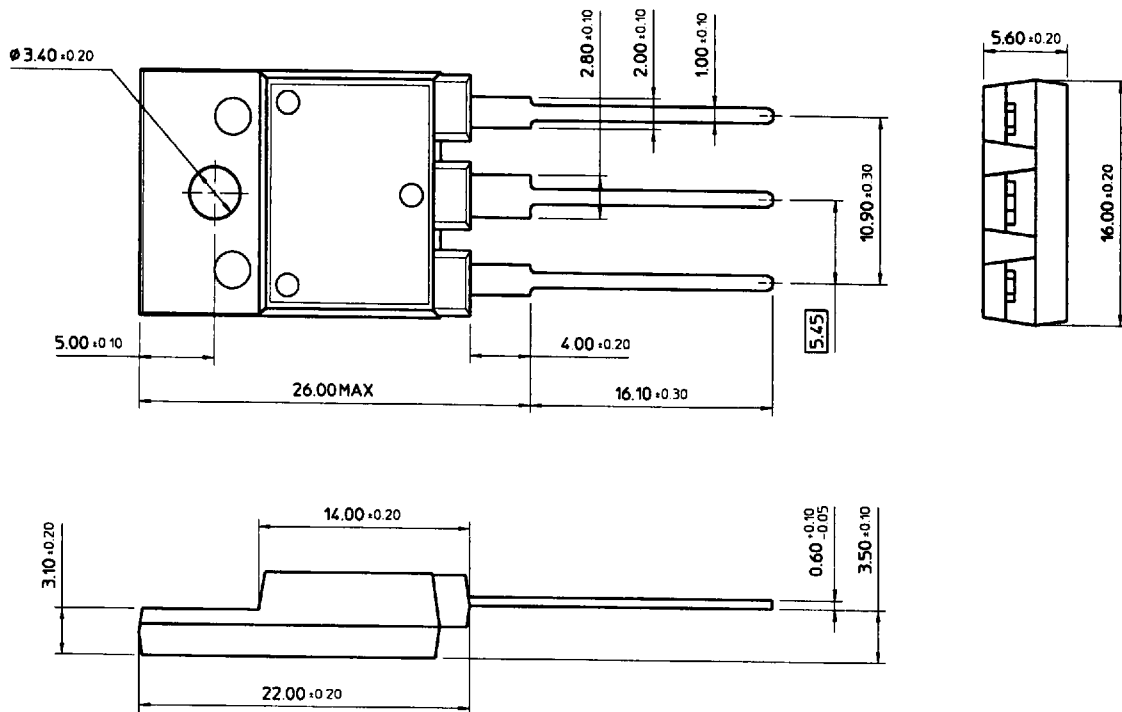

T0-3PF (3)

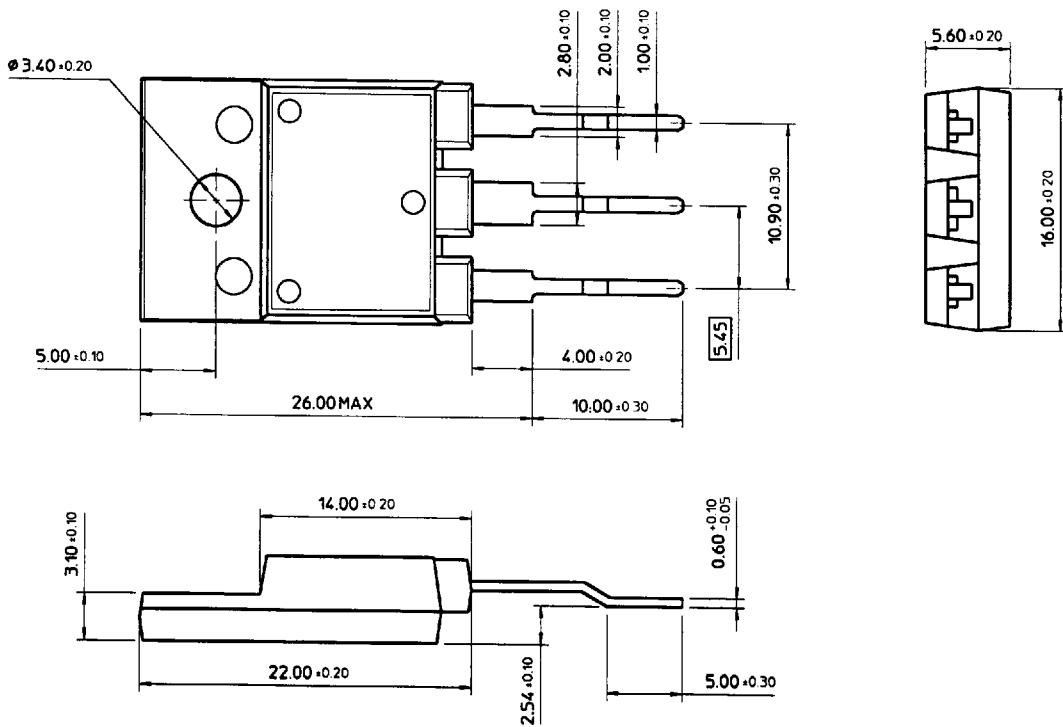

TO-3PF (4)

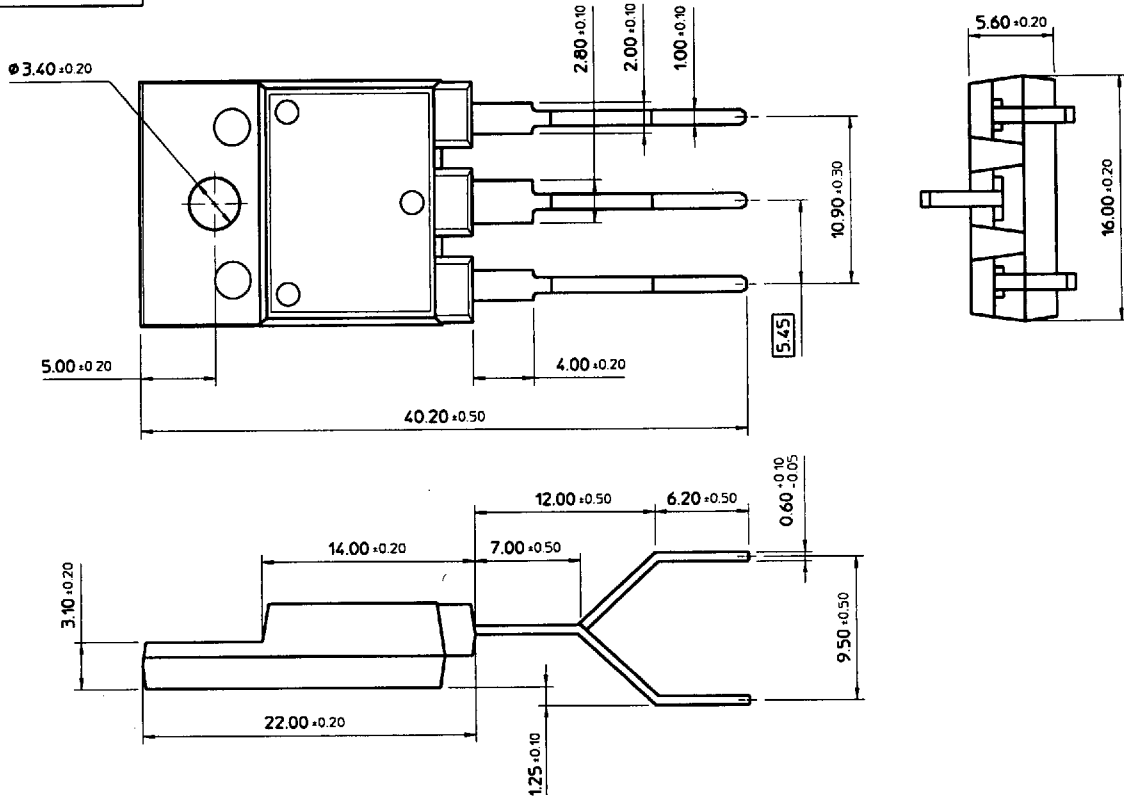

TO-3P-5L

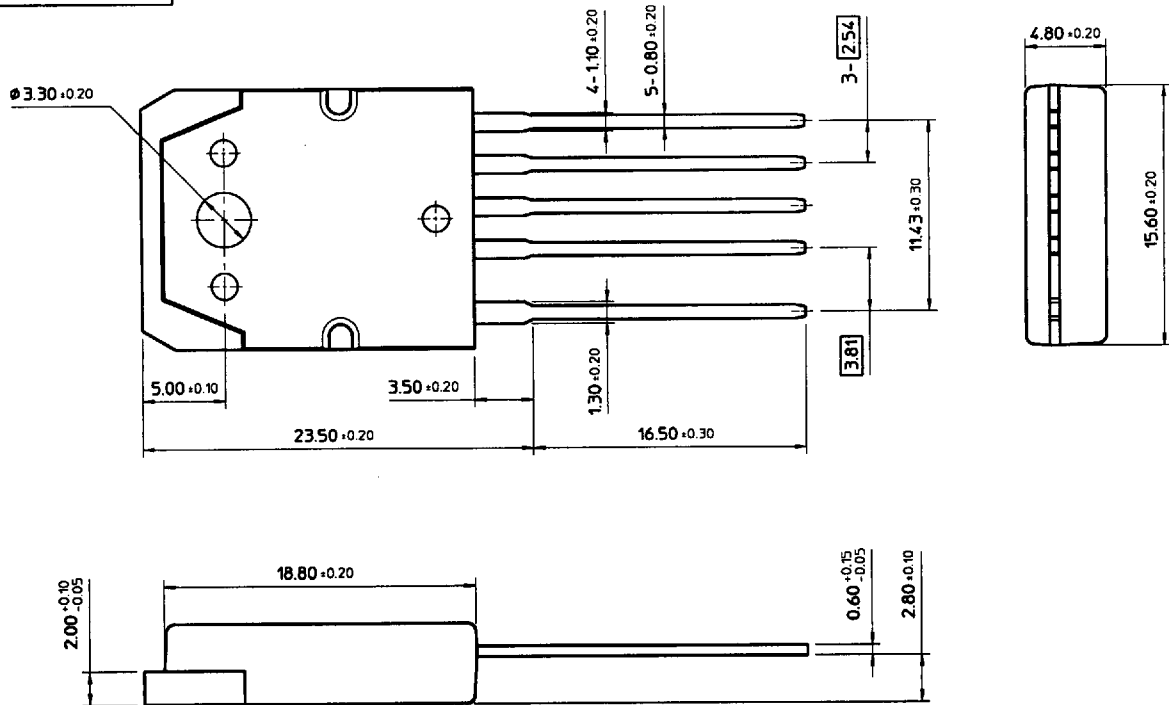

Under Development