

# KA5M0965Q

## Fairchild Power Switch(SPS)

### Features

- Precision fixed operating frequency (70kHz)
- Low start-up current(typ. 100uA)
- Pulse by pulse current limiting
- Over Load protection
- Over current protection
- Over voltage protection (Min. 25V)
- Internal thermal shutdown function
- Under voltage lockout
- Internal high voltage sense FET
- Latch mode

### Description

The SPS product family is specially designed for an off-line SMPS with minimal external components. The SPS consist of high voltage power SenseFET and current mode PWM IC. Included PWM controller features integrated fixed frequency oscillator, under voltage lock-out, leading edge blanking, optimized gate turn-on/turn-off driver, thermal shutdown protection, over voltage protection, and temperature compensated precision current sources for loopcompensation and fault protection circuitry. Compared to discrete MOSFET and PWM controller or RCC solution, a SPS can reduce total component count, design size, weight and at the same time increase efficiency, productivity, and system reliability. It has a basic platform well suited for cost-effective design in either a flyback converter or a forward converter.

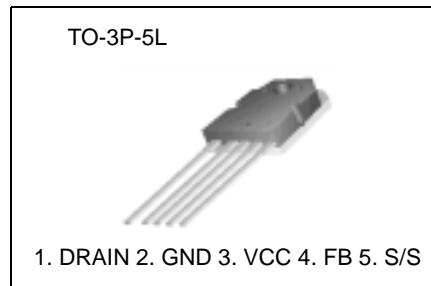

### Internal Block Diagram

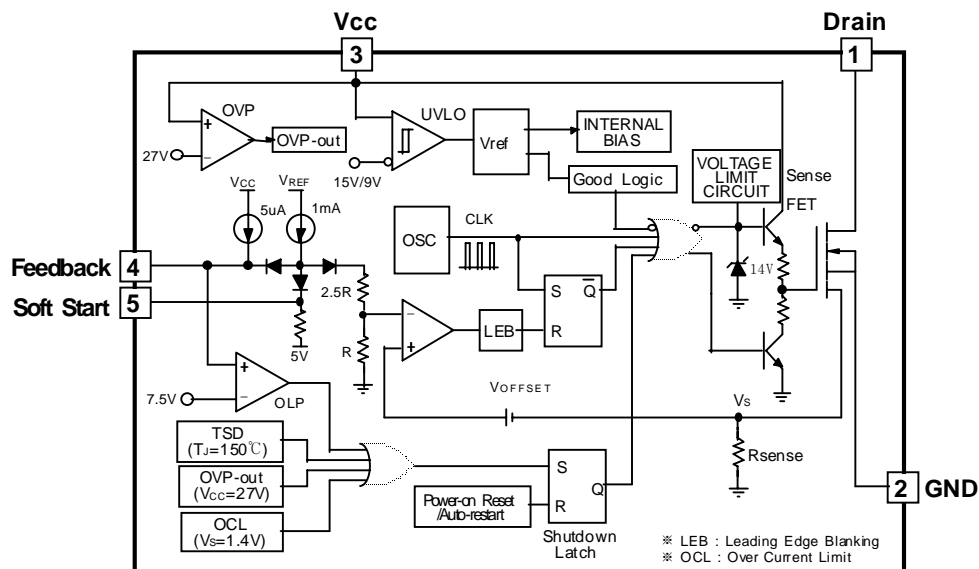

## Absolute Maximum Ratings

Characteristic	Symbol	Value	Unit
Maximum Drain voltage <sup>(1)</sup>	V <sub>D,MAX</sub>	650	V
Drain-Gate voltage (R <sub>GS</sub> =1MΩ)	V <sub>DGR</sub>	650	V
Gate-source (GND) voltage	V <sub>GS</sub>	±30	V
Drain current pulsed <sup>(2)</sup>	I <sub>DM</sub>	36.0	ADC
Single pulsed avalanche energy <sup>(3)</sup>	E <sub>AS</sub>	950	mJ
Continuous drain current (T <sub>C</sub> =25°C)	I <sub>D</sub>	9.0	ADC
Continuous drain current (T <sub>C</sub> =100°C)	I <sub>D</sub>	5.8	ADC
Maximum Supply voltage	V <sub>CC,MAX</sub>	30	V
Input voltage range	V <sub>FB</sub>	-0.3 to V <sub>SD</sub>	V
Total power dissipation	P <sub>D</sub> (watt H/S)	170	W
	Derating	1.33	W/°C
Operating ambient temperature	T <sub>A</sub>	-25 to +85	°C
Storage temperature	T <sub>STG</sub>	-55 to +150	°C

### Notes:

1. T<sub>j</sub>=25°C to 150°C
2. Repetitive rating: Pulse width limited by maximum junction temperature
3. L=20mH, V<sub>DD</sub>=50V, R<sub>G</sub>=27Ω, starting T<sub>j</sub>=25°C

## Electrical Characteristics (SFET part)

(Ta = 25°C unless otherwise specified)

Characteristic	Symbol	Test condition	Min.	Typ.	Max.	Unit
Drain-source breakdown voltage	BVDSS	VGS=0V, ID=50μA	650	-	-	V
Zero gate voltage drain current	IDSS	VDS=Max., Rating, VGS=0V	-	-	50	μA
		VDS=0.8Max., Rating, VGS=0V, TC=125°C	-	-	200	mA
Static drain-source on resistance <sup>(note)</sup>	RDS(ON)	VGS=10V, ID=4.5A	-	0.96	1.2	W
Forward transconductance <sup>(note)</sup>	gfs	VDS=50V, ID=4.5A	5.0	-	-	S
Input capacitance	Ciss	VGS=0V, VDS=25V, f=1MHz	-	1200	-	pF
Output capacitance	Coss		-	135	-	
Reverse transfer capacitance	Crss		-	25	-	
Turn on delay time	td(on)	VDD=0.5BVDSS, ID=9.0A (MOSFET switching time are essentially independent of operating temperature)	-	25	60	nS
Rise time	tr		-	75	160	
Turn off delay time	td(off)		-	130	270	
Fall time	tf		-	70	150	
Total gate charge (gate-source+gate-drain)	Qg	VGS=10V, ID=9.0A, VDS=0.8BVDSS	-	45	60	nC
Gate-source charge	Qgs		-	8	-	
Gate-drain (Miller) charge	Qgd		-	22	-	

**Note:**

Pulse test: Pulse width ≤ 300μS, duty ≤ 2%

$$S = \frac{1}{R}$$

**Electrical Characteristics (SFET part) (Continued)**

(Ta = 25°C unless otherwise specified)

Characteristic	Symbol	Test condition	Min.	Typ.	Max.	Unit
<b>UVLO SECTION</b>						
Start threshold voltage	VSTART	-	8.4	9	9.6	V
Stop threshold voltage	VSTOP	After turn on	14	15	16	V
<b>OSCILLATOR SECTION</b>						
Initial accuracy	FOSC	Ta=25°C	61	67	73	kHz
Frequency change with temperature <sup>(2)</sup>	-	-25°C≤Ta≤+85°C	-	±5	±10	%
Maximum duty cycle	Dmax	-	74	77	80	%
<b>FEEDBACK SECTION</b>						
Feedback source current	IFB	Ta=25°C, 0V≤Vfb≤3V	0.7	0.9	1.1	mA
Shutdown Feedback voltage	VSD	Vfb≥6.5V	6.9	7.5	8.1	V
Shutdown delay current	Idelay	Ta=25°C, 5V≤Vfb≤VSD	4	5	6	μA
<b>SOFT START SECTION</b>						
Soft Start Voltage	VSS	VFB =2V	4.7	5.0	5.3	V
Soft Start Current	ISS	Sync & S/S=GND	0.8	1.0	1.2	mA
<b>CURRENT LIMIT(SELF-PROTECTION)SECTION</b>						
Peak Current Limit	I <sub>OVER</sub>	Max. inductor current	5.28	6.00	6.72	A
<b>PROTECTION SECTION</b>						
Thermal shutdown temperature (Tj) <sup>(1)</sup>	TSD	-	140	160	-	°C
Over voltage protection voltage	VOVP	VCC≥24V	25	27	29	V
<b>TOTAL DEVICE SECTION</b>						
Start Up current	ISTART	VCC=14V	-	0.1	0.17	mA
Operating supply current (control part only)	IOP	VCC≤28	-	7	12	mA

**NOTE:**

1. These parameters, although guaranteed, are not 100% tested in production
2. These parameters, although guaranteed, are tested in EDS(water test) process
3. These parameters are indicated Inductor current.

# Typical Performance Characteristics

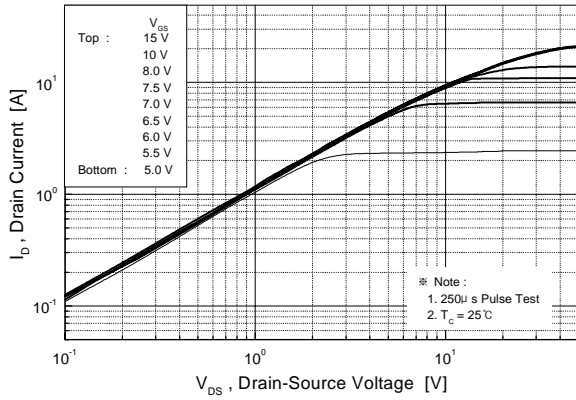

Figure 1. Output Characteristics

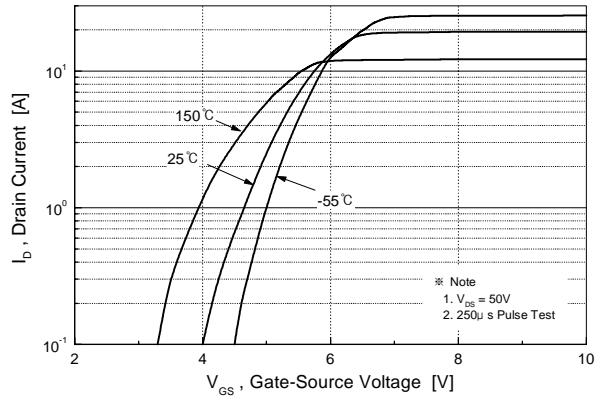

Figure 2. Transfer Characteristics

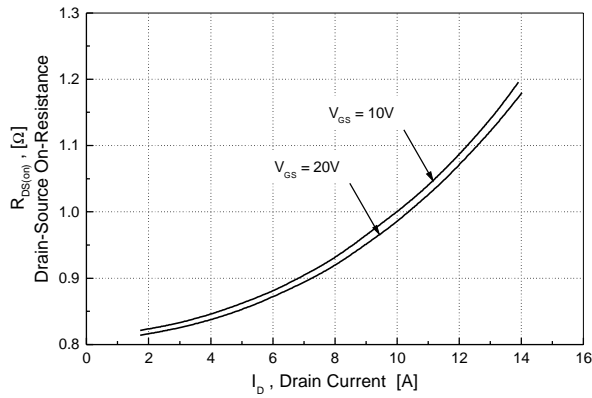

Figure 3. On-Resistance vs. Drain Current

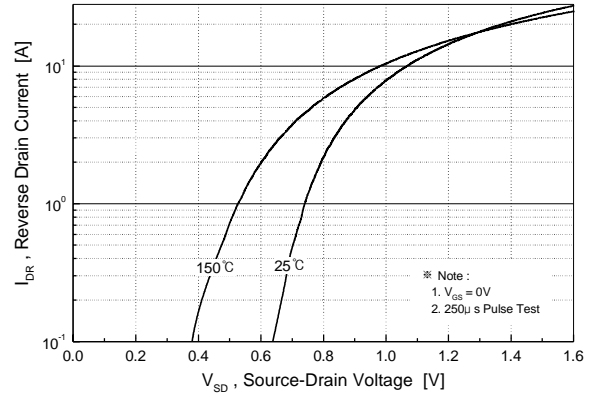

Figure 4. Source-Drain Diode Forward Voltage

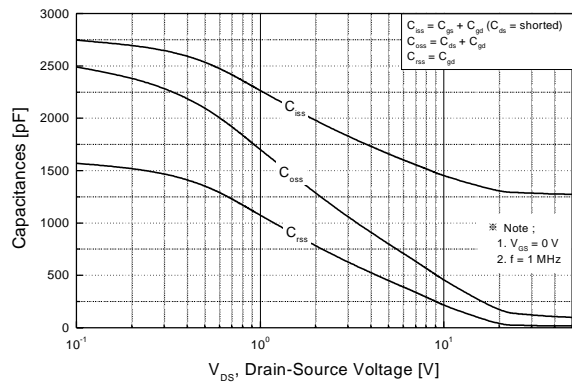

Figure 5. Capacitance vs. Drain-Source Voltage

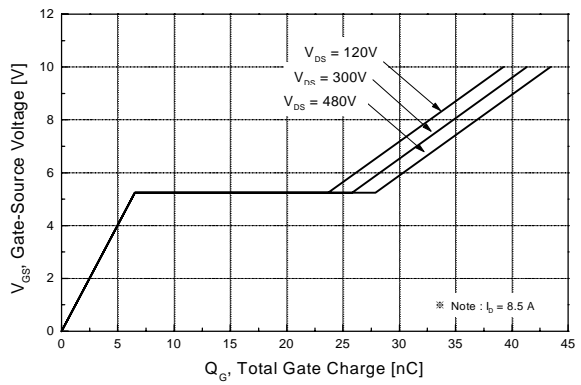

Figure 6. Gate Charge vs. Gate-Source Voltage

## Typical Performance Characteristics (Continued)

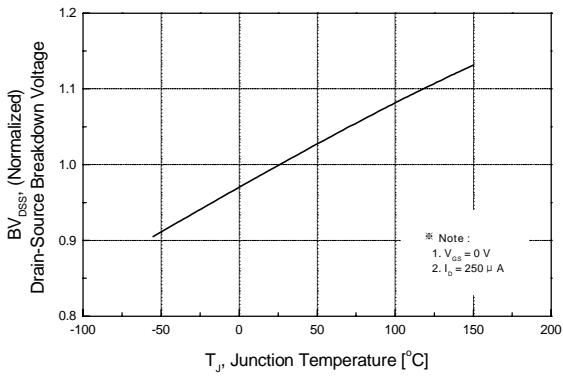

Figure 7. Breakdown Voltage vs. Temperature

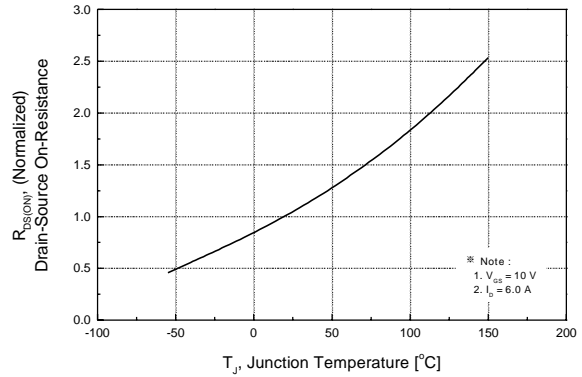

Figure 8. On-Resistance vs. Temperature

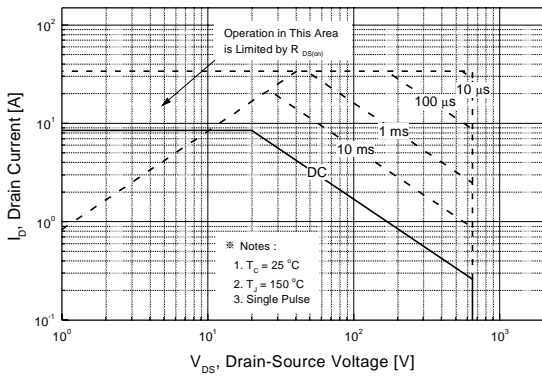

Figure 9. Max. Safe Operating Area

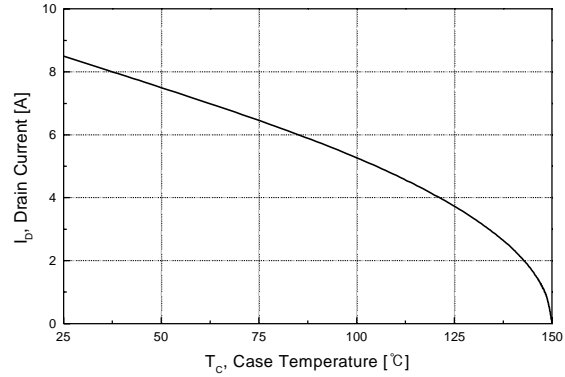

Figure 10. Max. Drain Current vs. Case Temperature

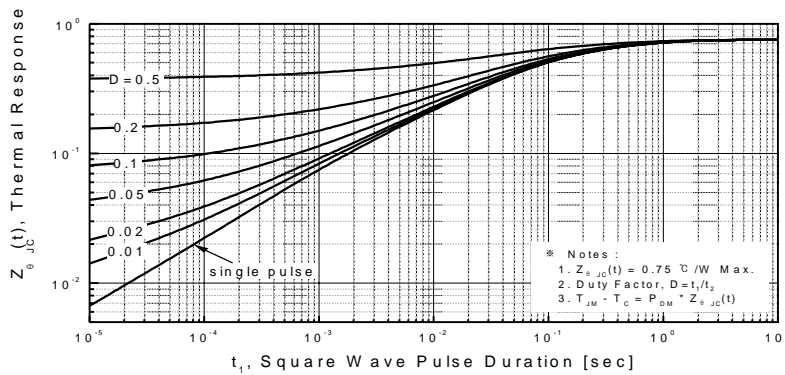

Figure 11. Thermal Response

## typical performance characteristics (control part)

(These characteristic graphs are normalized at  $T_a = 25^\circ\text{C}$ )

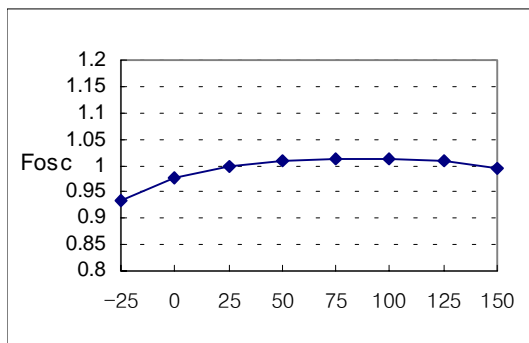

Figure 1. Operating Frequency

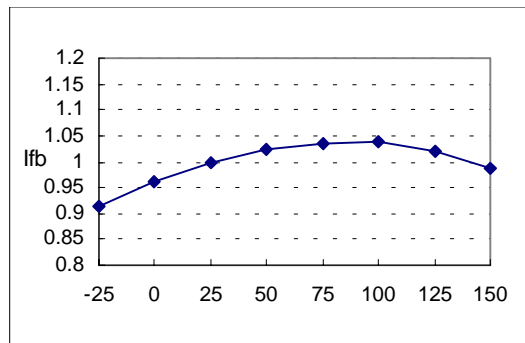

Figure 2. Feedback Source Current

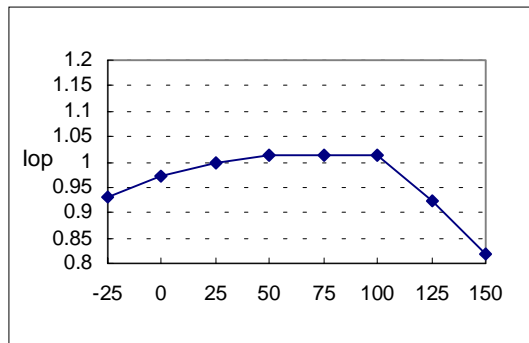

Figure 3. Operating Supply Current

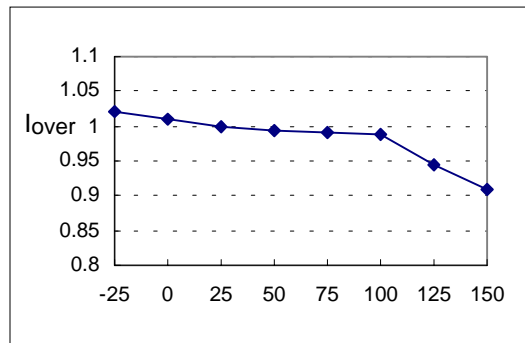

Figure 4. Peak Current Limit

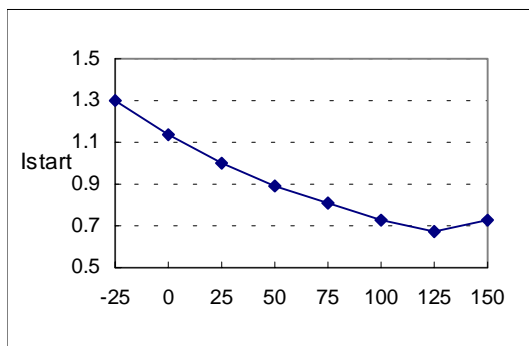

Figure 5. Start up Current

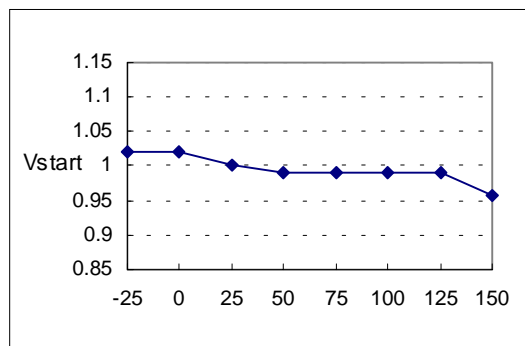

Figure 6. Start Threshold Voltage

## typical performance characteristics (continued)

(These characteristic graphs are normalized at  $T_a = 25^\circ\text{C}$ )

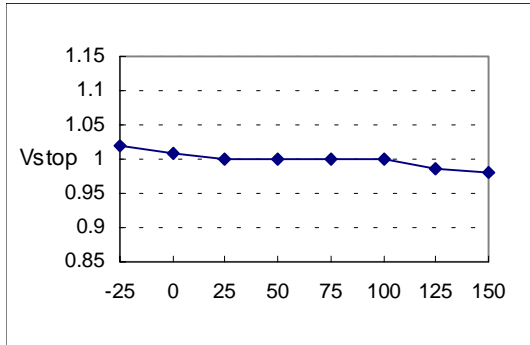

Figure 7. Stop Threshold Voltage

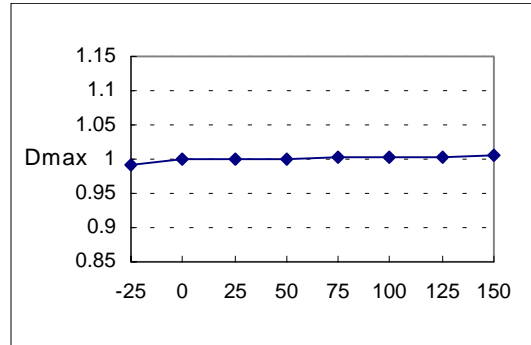

Figure 8. Maximum Duty Cycle

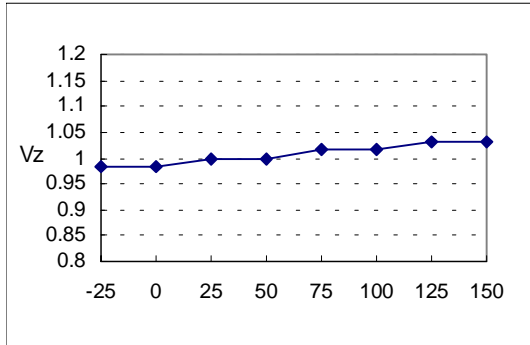

Figure 9. VCC Zener Voltage

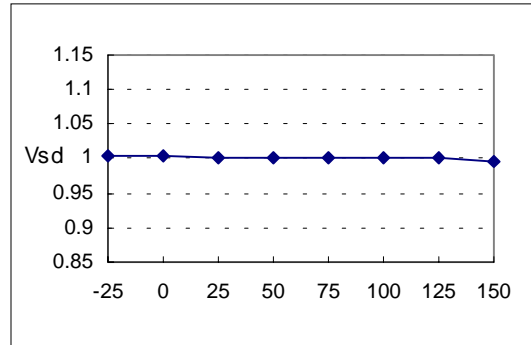

Figure 10. Shutdown Feedback Voltage

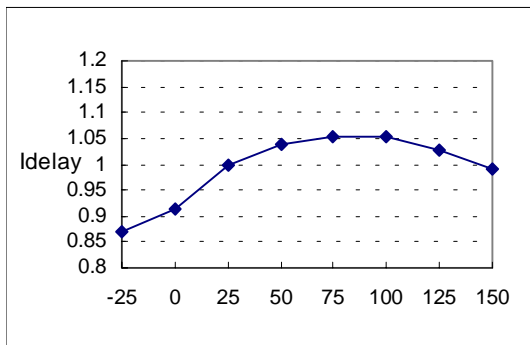

Figure 11. Shutdown Delay Current

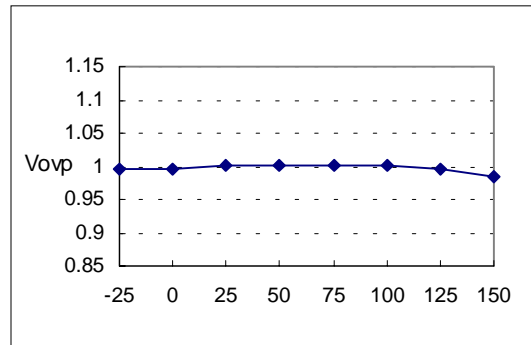

Figure 12. Over Voltage Protection



## typical performance characteristics (continued)

(These characteristic graphs are normalized at  $T_a = 25^\circ\text{C}$ )

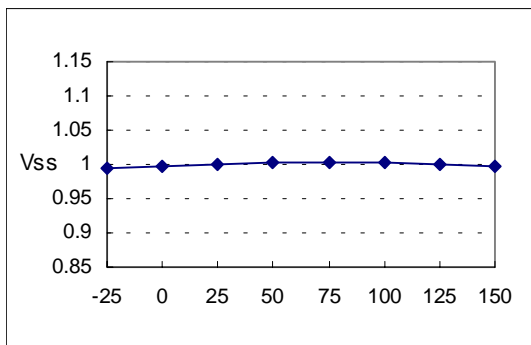

Figure13. Soft Start Voltage

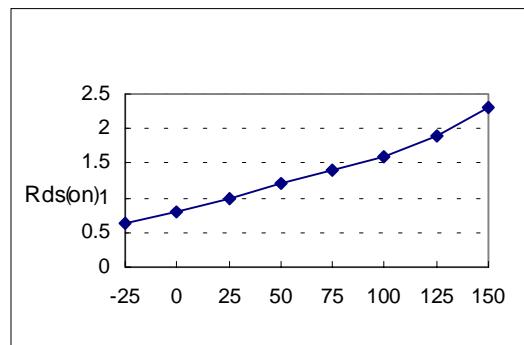
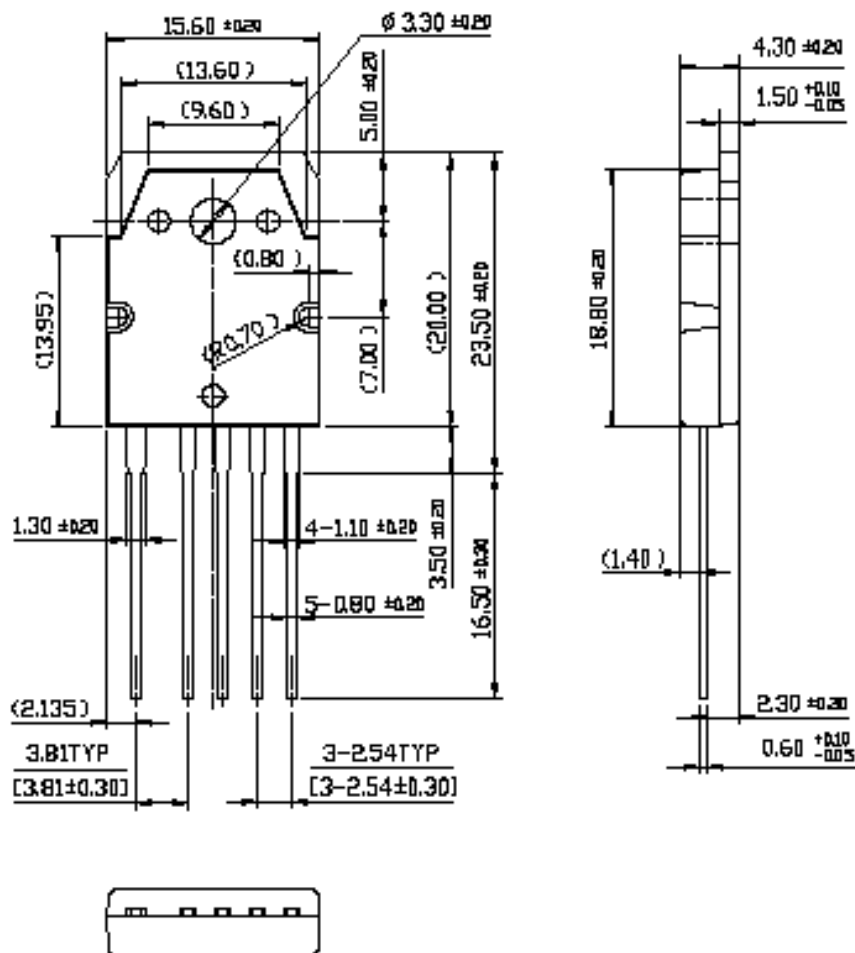

Figure 14. Static Drain-Source on Resistance

Package Dimensions

TO-3P-5L



## Package Dimensions (Continued)

## TO-3P-5L (Forming)

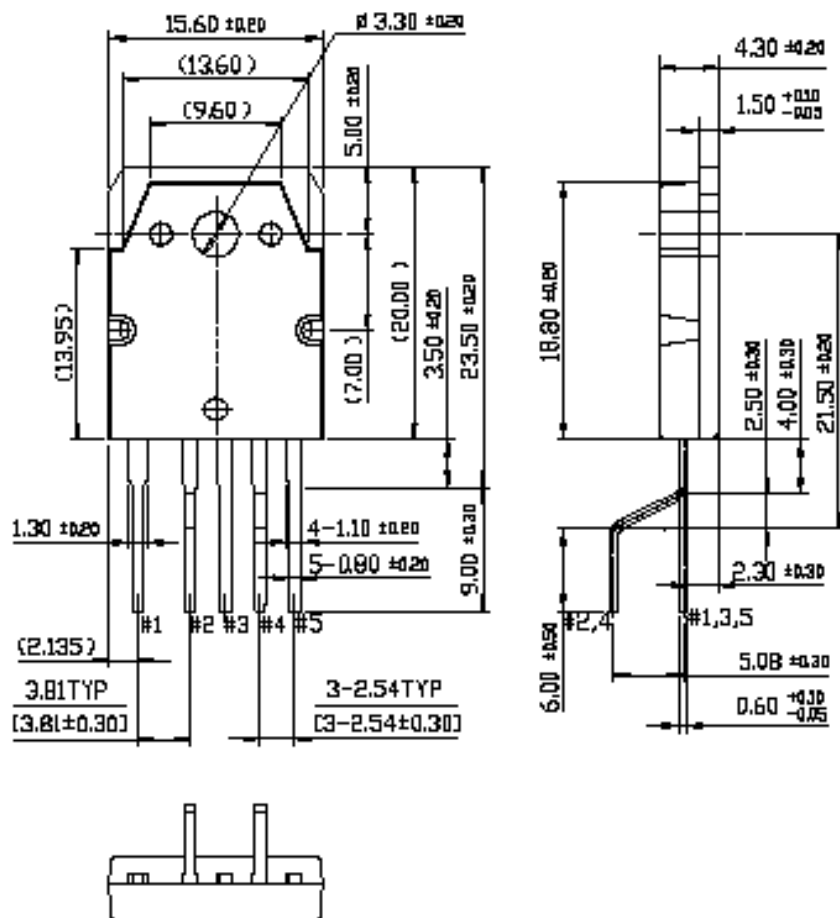

**Ordering Information**

<b>Product Number</b>	<b>Package</b>	<b>Rating</b>	<b>Operating Temperature</b>
KA5M0965Q-TU	TO-3P-5L	650V, 9A	-25°C to +85°C
KA5M0965Q-YDTU	TO-3P-5L(Forming)		

TU : Non Forming Type

YDTU : Forming Type



**DISCLAIMER**

FAIRCHILD SEMICONDUCTOR RESERVES THE RIGHT TO MAKE CHANGES WITHOUT FURTHER NOTICE TO ANY PRODUCTS HEREIN TO IMPROVE RELIABILITY, FUNCTION OR DESIGN. FAIRCHILD DOES NOT ASSUME ANY LIABILITY ARISING OUT OF THE APPLICATION OR USE OF ANY PRODUCT OR CIRCUIT DESCRIBED HEREIN; NEITHER DOES IT CONVEY ANY LICENSE UNDER ITS PATENT RIGHTS, NOR THE RIGHTS OF OTHERS.

**LIFE SUPPORT POLICY**

FAIRCHILD'S PRODUCTS ARE NOT AUTHORIZED FOR USE AS CRITICAL COMPONENTS IN LIFE SUPPORT DEVICES OR SYSTEMS WITHOUT THE EXPRESS WRITTEN APPROVAL OF THE PRESIDENT OF FAIRCHILD SEMICONDUCTOR CORPORATION. As used herein:

1. Life support devices or systems are devices or systems which, (a) are intended for surgical implant into the body, or (b) support or sustain life, and (c) whose failure to perform when properly used in accordance with instructions for use provided in the labeling, can be reasonably expected to result in a significant injury of the user.
2. A critical component in any component of a life support device or system whose failure to perform can be reasonably expected to cause the failure of the life support device or system, or to affect its safety or effectiveness.