

# KA78R15

## Low Dropout Voltage Regulator

### Features

- 1A / 15V Output low dropout voltage regulator
- TO220 Full-Mold package (4Pin)
- Overcurrent protection, Thermal shutdown
- Overvoltage protection, Short-Circuit protection
- With output disable function

### Description

The KA78R15 is a low-dropout voltage regulator suitable for various electronic equipments. It provides constant voltage power source with TO-220 4 lead full mold package. Dropout voltage of KA78R15 is below 0.5V in full rated current(1A). This regulator has various function such as peak current protection, thermal shut down, overvoltage protection and output disable function.



### Internal Block Diagram

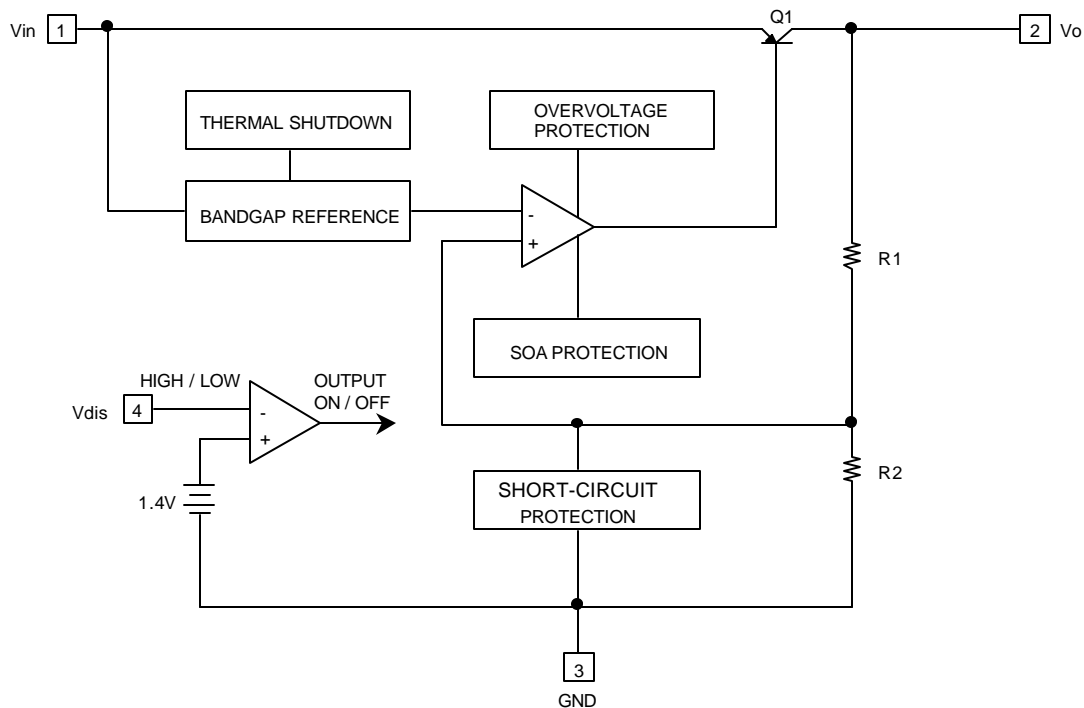

## Absolute Maximum Ratings

Parameter	Symbol	Value	Unit	Remark
Input Voltage	V <sub>in</sub>	35	V	-
Disable Voltage	V <sub>dis</sub>	35	V	-
Output Current	I <sub>o</sub>	1.0	A	-
Power Dissipation 1	P <sub>d1</sub>	1.5	W	No Heatsink
Power Dissipation 2	P <sub>d2</sub>	15	W	With Heatsink
Junction Temperature	T <sub>j</sub>	+150	°C	-
Operating Temperature	T <sub>opr</sub>	-20 ~ +80	°C	-

## Electrical Characteristics

(V<sub>in</sub> = 20V, I<sub>o</sub> = 0.5A, T<sub>a</sub> = 25°C, unless otherwise specified)

Parameter	Symbol	Conditions	Min.	Typ.	Max.	Unit
Output Voltage	V <sub>o</sub>	-	14.6	15	15.4	V
Load Regulation	R <sub>load</sub>	5mA < I <sub>o</sub> < 1A	-	0.1	2.0	%
Line Regulation	R <sub>line</sub>	16V < V <sub>in</sub> < 30V	-	0.5	2.5	%
Ripple Rejection Ratio	RR	note1	45	55	-	dB
Dropout Voltage	V <sub>drop</sub>	I <sub>o</sub> = 1A	-	-	0.5	V
Disable Voltage High	V <sub>disH</sub>	Output Active	2.0	-	-	V
Disable Voltage Low	V <sub>disL</sub>	Output Disabled	-	-	0.8	V
Disable Bias Current High	I <sub>disH</sub>	V <sub>dis</sub> = 2.7V	-	-	20	μA
Disable Bias Current Low	I <sub>disL</sub>	V <sub>dis</sub> = 0.4V	-	-	-0.4	mA
Quiescent Current	I <sub>q</sub>	I <sub>o</sub> = 0A	-	-	10	mA

### Note:

1. These parameters, although guaranteed, are not 100% tested in production.

## Typical Performance Characteristics

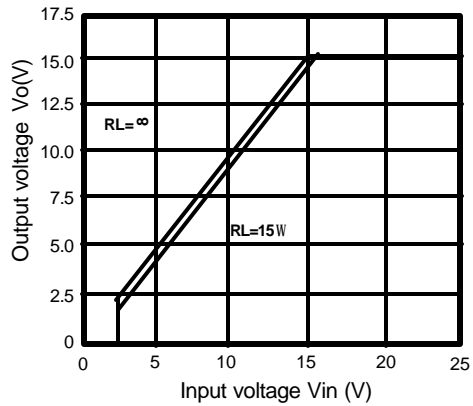

Figure 1. Output Voltage vs. Input Voltage

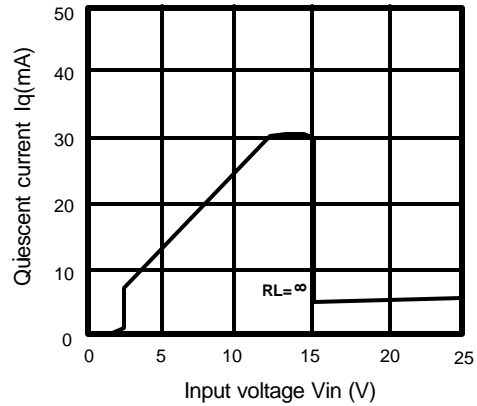

Figure 2. Quiescent Current vs. Input Voltage

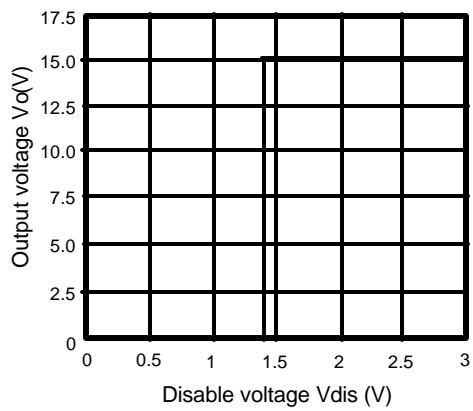

Figure 3. Output Voltage vs. Disable Voltage

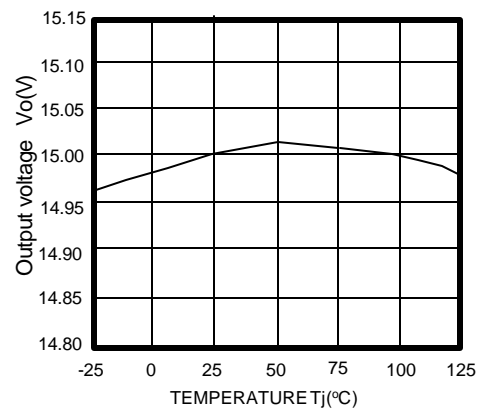

Figure 4. Output Voltage vs. Temperature(Tj)

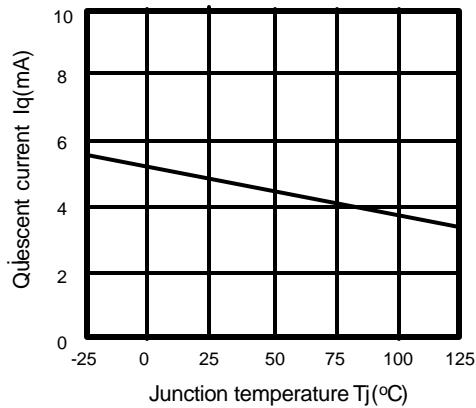

Figure 5. Quiescent Current vs. Temperature(Tj)

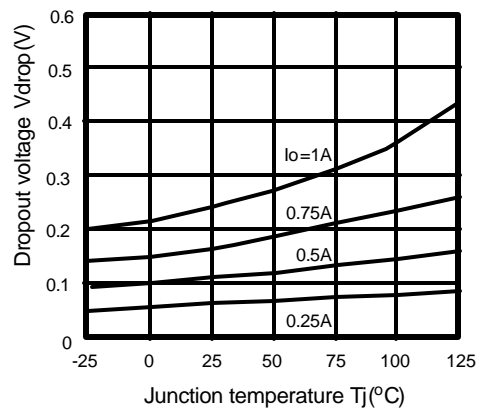

Figure 6. Dropout Voltage vs. Junction Temperature

Typical Performance Characteristics (continued)

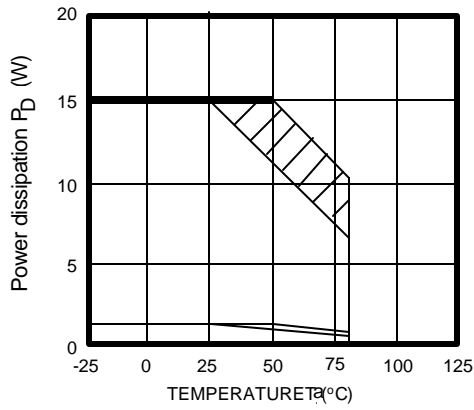

Figure 7. Power Dissipation vs. Temperature (Ta)

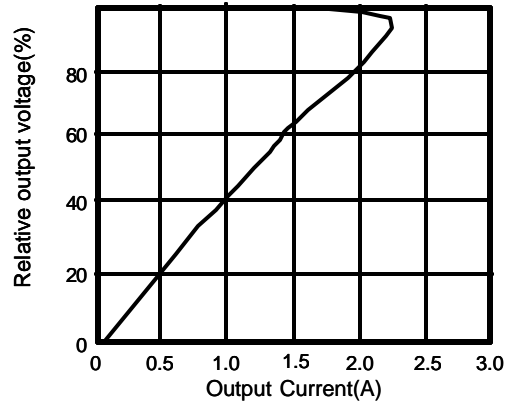
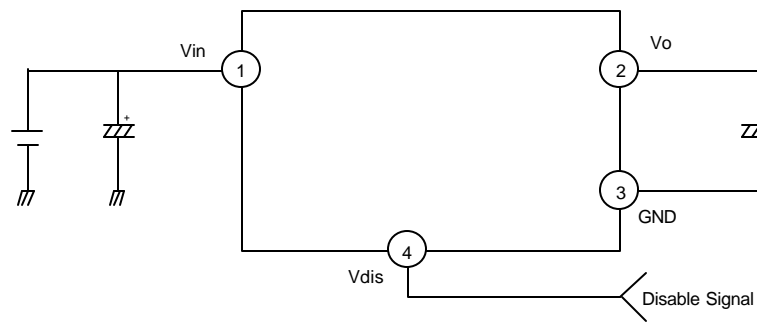

Figure 8. Overcurrent Protection Characteristics (Typical Value)

## Typical Application



**Figure 1.Application Circuit**

- $C_i$  is required if regulator is located an appreciable distance from power supply filter.
- $C_o$  improves stability and transient response. ( $C_o > 47\mu F$ )

# Mechanical Dimensions

Package

Dimensions in millimeters

## TO-220F-4L

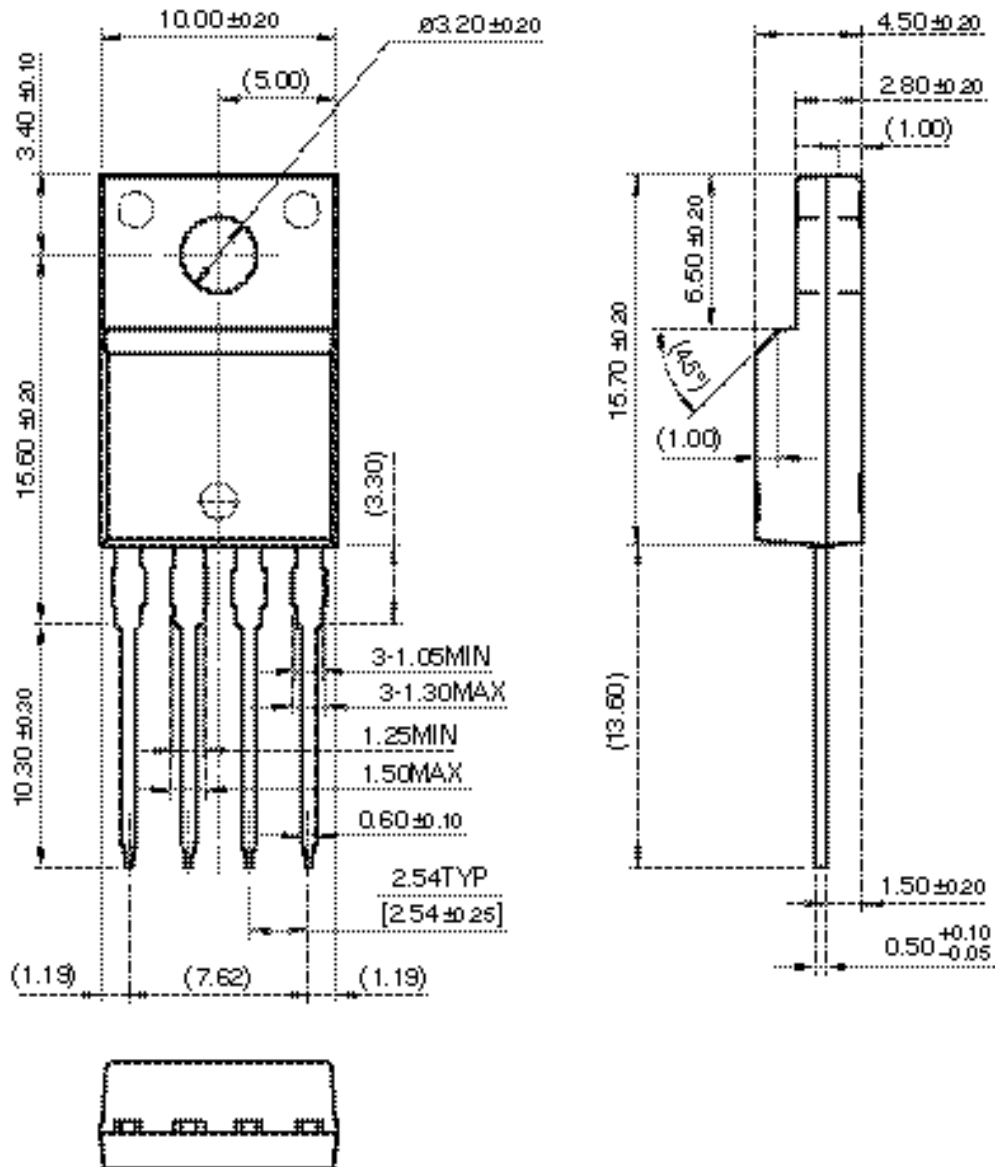

---

## Ordering Information

Product Number	Package	Operating Temperature
KA78R15	TO-220F-4L	-20°C to + 80°C

**DISCLAIMER**

FAIRCHILD SEMICONDUCTOR RESERVES THE RIGHT TO MAKE CHANGES WITHOUT FURTHER NOTICE TO ANY PRODUCTS HEREIN TO IMPROVE RELIABILITY, FUNCTION OR DESIGN. FAIRCHILD DOES NOT ASSUME ANY LIABILITY ARISING OUT OF THE APPLICATION OR USE OF ANY PRODUCT OR CIRCUIT DESCRIBED HEREIN; NEITHER DOES IT CONVEY ANY LICENSE UNDER ITS PATENT RIGHTS, NOR THE RIGHTS OF OTHERS.

**LIFE SUPPORT POLICY**

FAIRCHILD' S PRODUCTS ARE NOT AUTHORIZED FOR USE AS CRITICAL COMPONENTS IN LIFE SUPPORT DEVICES OR SYSTEMS WITHOUT THE EXPRESS WRITTEN APPROVAL OF THE PRESIDENT OF FAIRCHILD SEMICONDUCTOR CORPORATION. As used herein:

1. Life support devices or systems are devices or systems which, (a) are intended for surgical implant into the body, or (b) support or sustain life, and (c) whose failure to perform when properly used in accordance with instructions for use provided in the labeling, can be reasonably expected to result in a significant injury of the user.
2. A critical component in any component of a life support device or system whose failure to perform can be reasonably expected to cause the failure of the life support device or system, or to affect its safety or effectiveness.