

DataSheet4U.com

KENWOOD

www.DataSheet4U.com

KAC-746

4-CHANNEL POWER AMPLIFIER

INSTRUCTION MANUAL

KENWOOD CORPORATION

DataSheet4U.com

DataSheet4U.com

DataSheet4U.com

DataSheet4U.com

www.DataSheet4U.com

Safety precautions

▲WARNING

Take the following precautions to prevent fire and avoid personal injury :

- When extending the battery cable, or ground cable, use 5mm² (AWG10) or larger automotive grade cable to avoid cable deterioration or damage to the covering.
- Check that no metal objects (coins, tools, etc.) are left inside the unit to avoid short circuits.
- If you smell or see smoke, turn the power off immediately and consult your Kenwood dealer.
- Do not touch the unit during use because the surface of the unit becomes hot and may cause burns if touched.

▲CAUTION

Take the following precautions to keep the unit in proper working order.

- Be sure the unit is connected to a 12V DC power supply with a negative ground connection.

- Do not open the top or bottom cover.
- Do not install the unit in places it is exposed to direct sunlight, high heat or humidity, water may splash over it, or dust exists.

NOTE

- If you have difficulty in installing this unit in your vehicle, contact your Kenwood dealer.









Cleaning the unit

- If the surface is dirty, wipe it clean with a silicon cloth or soft dry cloth with the power off.

▲CAUTION

Do not use hard cloths or paint thinner, alcohol, or other volatile solvents. These may damage external surfaces or remove indicator characters.

Accessories

Part name	External View	Number of Items	Part name	External View	Number of Items
Battery cable (Yellow) (6 m)		1	Round terminal (Large)		1
Ground cable (Black) (1 m)		1	Round terminal (Medium)		2
Self-tapping screws (ø4 × 16 mm)		4	Round terminal (Small)		1
Terminal cover (Power terminal)		1	Grommets		1

Installation procedure

1. Remove the ignition key and disconnect the negative \ominus terminal of the battery to prevent short circuits.
2. Set the unit according to the intended usage.
3. Connect the input and output cables of the units.
4. Connect the speaker cables.
5. Connect the power cable, power control cable and grounding cable following this order.
6. Install the unit in the car.
7. Connect the negative \ominus terminal of the battery.

▲CAUTION

- Be sure to turn the power off before changing the setting of any switch.
- If the fuse blows, check cables for shorts, then replace the fuse with one of the same rating.
- Check that no unconnected cables or connectors are touching the car body. Do not remove caps from unconnected cables or connectors to prevent short circuits.
- Connect the speaker cables to appropriate speaker connectors separately. Sharing the negative cable of the speaker or grounding speaker cables to the metal body of the car can cause this unit to fail.
- After installation, check that the brake lamps, wipers, and wipers work properly.

Installation

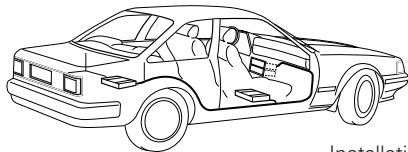

Self-tapping screw
($\phi 4 \times 16$ mm)

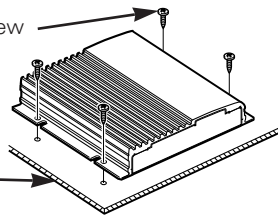

Installation board, etc.
(thickness : 15 mm or more)

- Since the power amplifier has no parts which require operation, it can be installed at a position away from the driver's seat without any hindrances.
As generally accepted positions for its installation, places such as inside the trunk, etc. can be considered.
- Use the extension cables. (Optional.)

Type	Length	0.5m	1m	2m	4m	5m	6m
RCA cable		CA-2SL	CA-12SL	CA-22SL	—	CA-52SL	—
RCA cable ($\phi 7$ mm)		CA-3WL	CA-13WL	CA-23WL	—	CA-53WL	—
RCA cable ($\phi 12$ mm)		CA-5W	CA-15W	CA-25W	CA-45W	—	CA-65W

▲CAUTION

- Do not install the unit under the carpet. Otherwise heat build-up occurs and the unit may be damaged.
- Install this unit in a location which allows heat to easily dissipate.
Once installed, do not place any object on top of the unit.
- After installing the unit, check to make sure that electrical equipment such as the brake lamps, turn signal lamps and windshield wipers operate normally.
- Install the unit securely in a location that does not interfere with driving.

Controls

This is a 4 channel amplifier including 2 stereo amplifiers in a body. One amplifier is referred to as amplifier A and the other is amplifier B. This unit is compatible with a large variety of systems by combining the switches and functions described in the following.

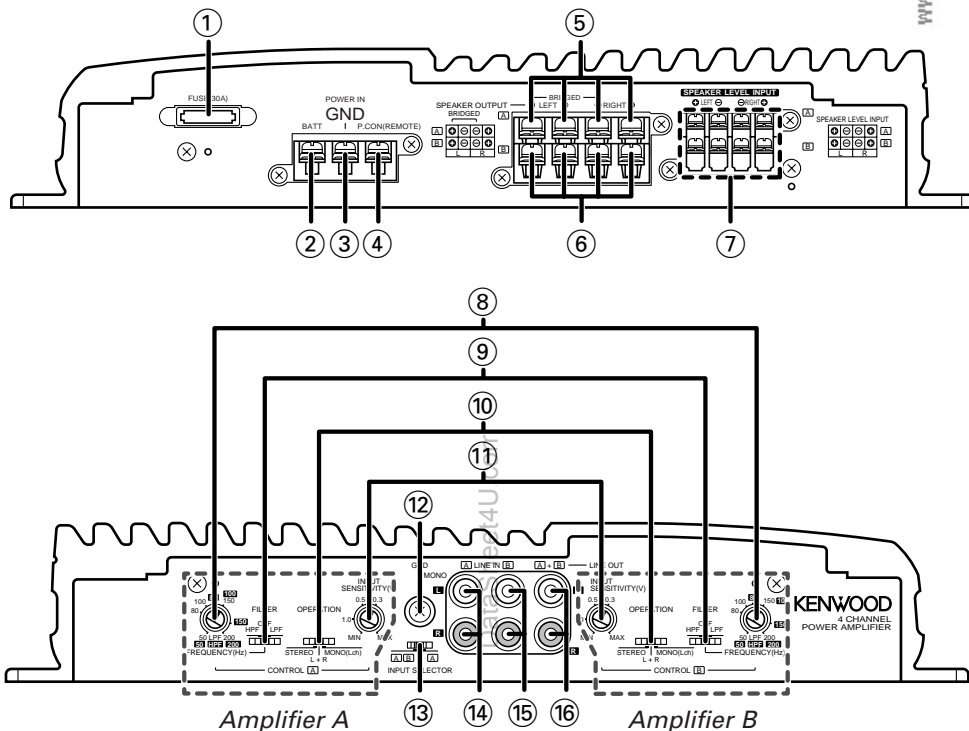

- ① Fuse (30 A)
- ② Battery terminal
- ③ Ground terminal
- ④ Power control (REMOTE) terminal
- ⑤ Amplifier A speaker output terminals
- ⑥ Amplifier B speaker output terminals
- ⑦ Speaker level input terminals
- ⑧ FREQUENCY control

When the FILTER switch is set to the HPF (High-Pass Filter) or LPF (Low-Pass Filter) position, the threshold frequency can be adjusted with this control.

- ⑨ FILTER switch
High-pass or low-pass filtering can be applied to the speaker output according to the setting of this switch.
- ⑩ OPERATION switch
The amplification methods of the signals input to amplifiers A and B can be selected independently according to the setting of this switch.

- **STEREO position:**

The amplifier can be used as a stereo amplifier.

- **L+R position:**

The input left and right signals are combined before being amplified. Use this position when the unit is used for subwoofer speakers or the L+R (monaural) sound is required.

- **MONO (Lch) position:**

Amplifies the signal input from the left side only. Set to this position and make bridged connections to use as a high-power monaural amplifier. (The input right signal is not output.)

⑪ **INPUT SENSITIVITY control**

Set this control according to the pre-output level of the center unit connected with this unit, or to the maximum power output of the genuine-accessory car stereo.

Use the diagram on the right as a guide.

NOTE

For the pre-output level or the maximum power output, refer to the "Specifications" in the instruction manual of the center unit.

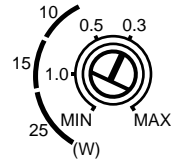

⑫ **RCA cable ground lead terminal**

⑬ **INPUT SELECTOR switch**

This switch selects the input method of the signals to be amplified by amplifiers A and B.

- **[A] [B] position:**

Amplifies both of the signals input to amplifiers A and B.

- **[A] position:**

Amplifies only signal input amplifier A with both amplifiers A and B.

⑭ **Amplifier A LINE IN terminal**

⑮ **Amplifier B LINE IN terminal**

⑯ **LINE OUT terminal**

These jacks output respectively the signals input to amplifiers A and B. They always output the stereo signals regardless of the position of the OPERATION switch.

Protection function

This unit is equipped with a protection function for protecting this unit and your speakers from various accidents or problems that can occur.

When the protection function is triggered, the Power indicator goes off and the amplifier stops operating.

■ **Power indicator:**

When the power is turned on, the Power indicator lights.

If the Power indicator does not light when the power is turned on, the protection function may be activated. Check whether there is any indication of trouble.

■ **The protection function activates in the following situations:**

- When a speaker output contacts ground.
- When the unit malfunctions and a DC signal is sent to the speaker output.
- When the temperature of internal parts exceeds 120°C (248°F).
- When a ground cable of the center unit (cassette receiver, CD receiver, etc.) or this unit is not connected to a metal part serving as an electrical ground passing electricity to the battery's negative ⊖ terminal.

Power indicator

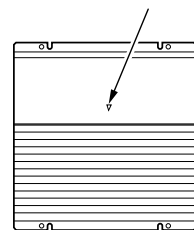

Connection

RCA cable connection

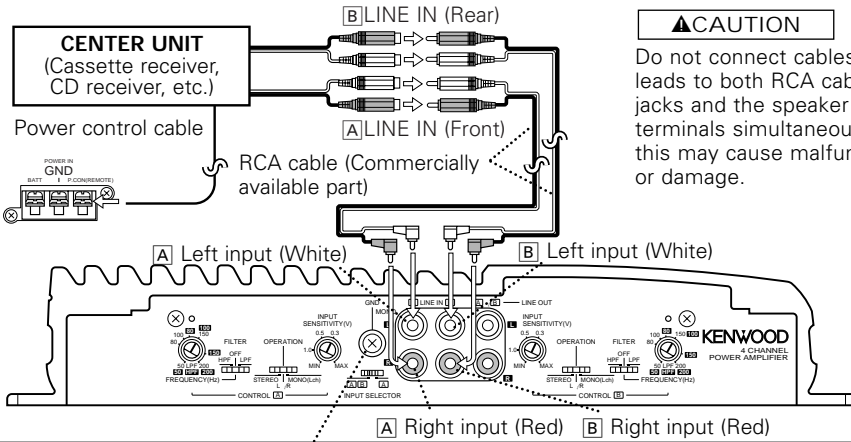

RCA cable ground terminal

When using an RCA cable with a ground lead attached, connect the ground lead to this terminal.

▲ **CAUTION**

Do not use this terminal for power source grounding. This unit will be damaged if the power source grounding wire is connected to this terminal.

Speaker level input connection

Connect the unit by inserting it in the connection between the genuine-accessory car stereo and speakers.

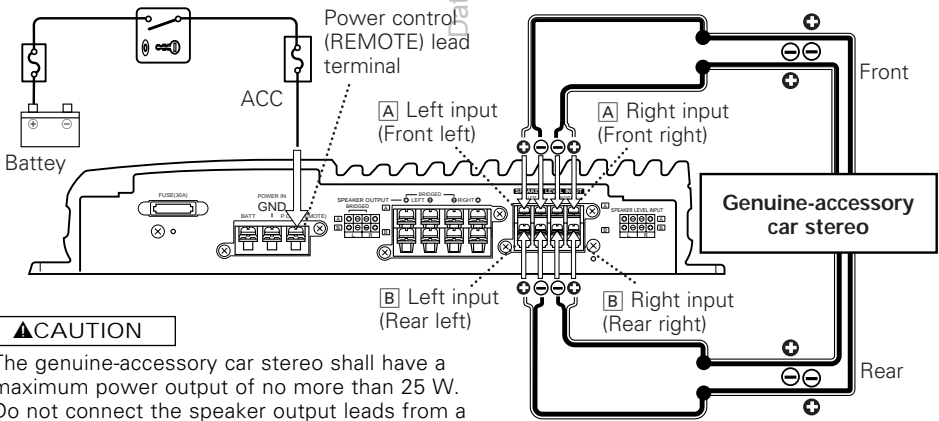

- ▲ **CAUTION**
- The genuine-accessory car stereo shall have a maximum power output of no more than 25 W.
 - Do not connect the speaker output leads from a power amplifier (Optional) to the speaker input terminals of this unit, for this may cause malfunction or damage.
 - Do not connect cables and leads to both RCA cable input jacks and the speaker input terminals simultaneously, for this may cause malfunction or damage.
 - Connect the power control lead to a power supply which can be turned ON/OFF by the ignition key switch (ACC line).
With this connection, shock noise may be generated when the power of the genuine-accessory car stereo is switched ON/OFF.

Power and Speakers cable connection

- If a buzzing noise is heard from the speakers when the engine is running, connect a line noise filter (optional) to each of the battery cable.
- Do not allow the cord to directly contact the edge of the iron plate by using Grommets.

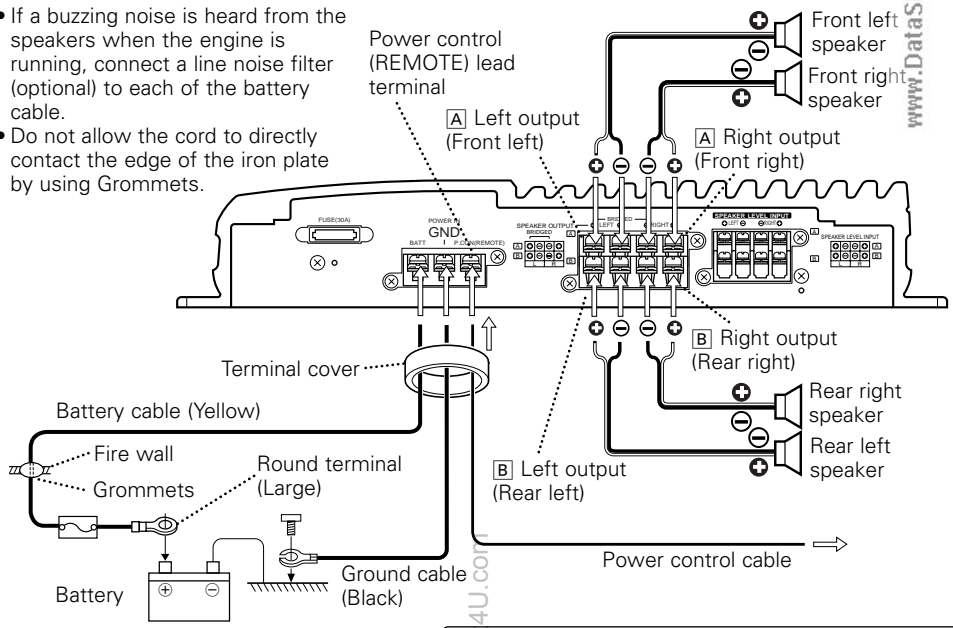

⚠ WARNING

To prevent fire caused by a short in the wiring, connect a fusible link or breaker nearby the battery's positive terminal.

NOTE

Connect the ground cable to a metal part of the car chassis that acts as an electrical ground passing electricity to the battery's negative \ominus terminal. Do not turn the power on if the ground cable is not connected.

Power terminal

Pass battery and ground cables through supplied terminal cover and connect to respective terminals. After completing connections, fasten terminal cover over terminal bracket.

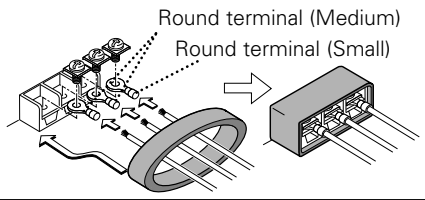

(Bridged)

⚠ CAUTION

If you wish to bridge-connect a speaker, the speaker impedance must be no less than 4 ohms. Connecting a speaker with an impedance lower than 4 ohms may damage the unit.

examples:

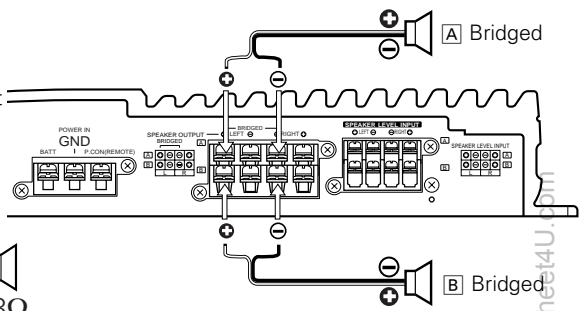
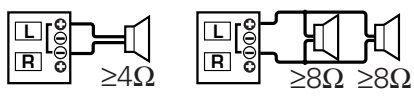

System examples

Full-range 4-channel + Subwoofer system

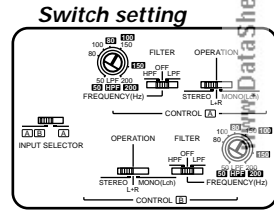
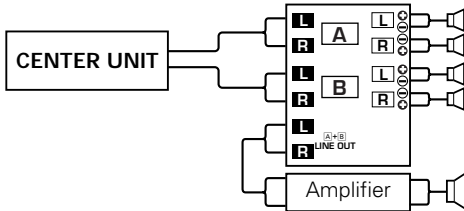

High-power 2-channel system

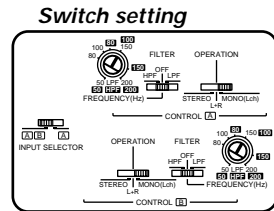
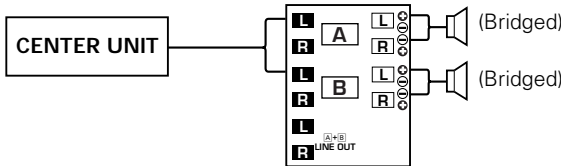

High-pass (80 Hz) + Subwoofer(80 Hz) system

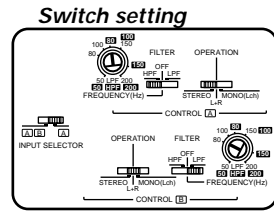
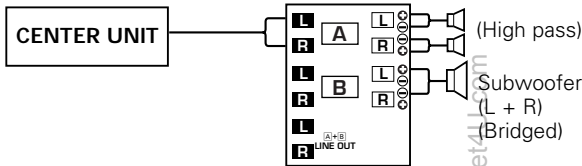

Tri-mode

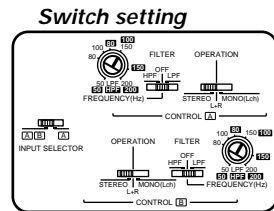
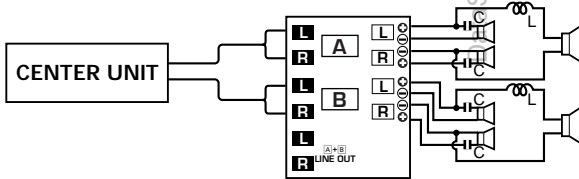

Principle of Tri-mode

Method of frequency band division using a coil and capacitor...in case of 6dB/oct. slope

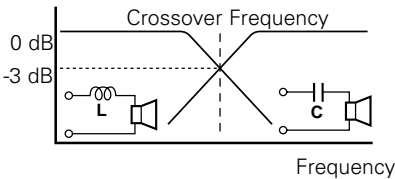

Coil (L): Passes low frequencies and blocks high frequencies. (Low pass)

Capacitor (C): Passes high frequencies and blocks low frequencies. (High pass)

$$C = \frac{159000}{f_c \times R} (\mu F) \quad f_c = \text{Cut of Frequency (Hz)} \quad R = \text{Speaker Impedance } (\Omega)$$

$$L = \frac{159 \times R}{f_c} (\text{mH})$$

Example:

When it is required to set a crossover frequency of 120 Hz using speakers with an impedance of 4 ohms.

Prepare commercially-available coil and capacitor with the closest ratings to the results calculated from the formula above. The capacitor rating should be as close as possible to 331.25 (μF) and the coil rating should be as close as possible to 5.3 (mH).

CAUTION

If you wish to bridge-connect a speaker, the speaker impedance must be no less than 4 ohms. Connecting a speaker with an impedance lower than 4 ohms may damage the unit.

Troubleshooting guide

Often, what appears to be a malfunction is due to user error. Before calling for service, please consult the following table.

Symptom	Cause	Remedy
No sound. (No sound from one side.)	<ul style="list-style-type: none"> • Input (or output) cables are disconnected. • Protection circuit may be activated. • The fuse may be blown because the volume was too high. 	<ul style="list-style-type: none"> • Connect the input (or output) cables. • Check connections by referring to "Protection function". • Replace the fuse with a new fuse and use a lower volume.
The output level is too small (or too large).	The input sensitivity adjusting control is not set to the correct position.	Adjust the control correctly referring to "Controls".
The sound quality is bad. (The sound is distorted.)	<ul style="list-style-type: none"> • The speakers cable are connected with wrong \oplus / \ominus polarity. • A speaker cable is pinched by a screw in the car body. • The switches may be set improperly. 	<ul style="list-style-type: none"> • Connect them properly checking the \oplus / \ominus of the terminals and cables well. • Connect the speaker cable again so that it is not pinched by anything. • Set switches properly by referring to "Controls" and "System examples".

Specifications

Specifications subject to change without notice.

Audio Section

Max Power Output (4 Ω)	
4 Channel Mode	70 W \times 4
3 Channel Mode	70 W \times 2 + 200 W \times 1
2 Channel Mode	200 W \times 2
Rated Power Output (4 Ω)	
4 Channel Mode	35 W \times 4 (DIN45324, +B=14.4 V)
3 Channel Mode)	35 W \times 2 (1 kHz, 0.08 % THD) + 100 W \times 1 (1 kHz, 0.8 % THD)
2 Channel Mode	100 W \times 2 (1 kHz, 0.8 % THD)
Rated Power Output (2 Ω)	
4 Channel Mode	50 W \times 4 (1 kHz, 0.8 % THD)
Frequency Response (+0, -1 dB)	5 Hz ~ 50 kHz
Signal to Noise Ratio	100 dB
Sensitivity (MAX) (rated output)	0.15 V
Sensitivity (MIN) (rated output)	4.0 V
Input Impedance	10 k Ω
Low Pass Filter (12 dB/oct.) (Variable)	50 ~ 200 Hz
High Pass Filter (12 dB/oct.) (Variable)	50 ~ 200 Hz

General

Operating Voltage	14.4 V (11 ~ 16 V allowable)
Current Consumption (1 kHz, 10% THD)	28 A
Dimensions (W \times H \times D)	290 \times 52 \times 230 mm
Weight	3.1 kg