

# KAF-4320

## 2084 (H) x 2085 (V) Full Frame CCD Image Sensor

### Description

The KAF-4320 Image Sensor is a high performance monochrome area CCD (charge-coupled device) image sensor designed for a wide range of image sensing applications.

The sensor incorporates true two-phase CCD technology, simplifying the support circuits required to drive the sensor as well as reducing dark current without compromising charge capacity. The sensor also utilizes the TRUESENSE Transparent Gate Electrode to improve sensitivity compared to the use of a standard front side illuminated polysilicon electrode.

The full imaging array is read out of four outputs, each of which is driven by a low impedance two stage source follower that provides a high conversion gain. This combination enables low noise at a net readout rate of 12 MHz (3 MHz per output).

**Table 1. GENERAL SPECIFICATIONS**

Parameter	Typical Value
Architecture	Full Frame CCD
Total Number of Pixels	2092 (H) x 2093 (V)
Number of Active Pixels	2084 (H) x 2085 (V) = approx. 4.3 Mp
Pixel Size	24 $\mu\text{m}$ (H) x 24 $\mu\text{m}$ (V)
Active Image Size	50.02 mm (H) x 50.02 mm (V) 70.7 mm (Diagonal) 645 Optical Format
Die Size	52.3 mm (H) x 52.7 mm (V)
Output Sensitivity	10 $\mu\text{V}/\text{e}^-$
Saturation Signal	500,000 electrons
Readout Noise	20 electrons (3 MHz)
Outputs	4
Dark Current	< 15 pA/cm <sup>2</sup>
Dark Current Doubling Temperature	6.4°C
Dynamic Range	20,000 : 1
Blooming Suppression	None
Maximum Data Rate	3 MHz
Package	PGA Package
Cover Glass	Clear

NOTE: Parameters above are specified at T = 25°C unless otherwise noted.



**ON Semiconductor®**

[www.onsemi.com](http://www.onsemi.com)

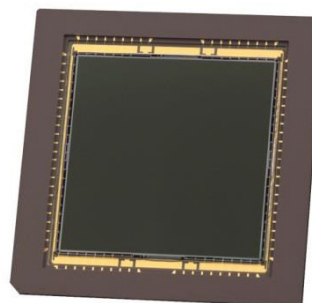

**Figure 1. KAF-4320 Full Frame CCD Image Sensor**

### Features

- True Two Phase Full Frame Architecture
- TRUESENSE Transparent Gate Electrode for High Sensitivity

### Applications

- Medical Imaging
- Scientific Imaging

### ORDERING INFORMATION

See detailed ordering and shipping information on page 2 of this data sheet.

# KAF-4320

## ORDERING INFORMATION

**Table 2. ORDERING INFORMATION – KAF-4320 IMAGE SENSOR**

Part Number	Description	Marking Code
KAF-4320-AAA-JP-B1	Monochrome, No Microlens, PGA Package, Taped Clear Cover Glass (No Coatings), Grade 1	KAF-4320-AAA Lot Number
KAF-4320-AAA-JP-B2	Monochrome, No Microlens, PGA Package, Taped Clear Cover Glass (No Coatings), Grade 2	
KAF-4320-AAA-JP-AE	Monochrome, No Microlens, PGA Package, Taped Clear Cover Glass (No Coatings), Engineering Sample	

**Table 3. ORDERING INFORMATION – EVALUATION SUPPORT**

Part Number	Description
KAF-4320-16-3-A-EVK	Evaluation Board (Complete Kit)

See the ON Semiconductor *Device Nomenclature* document (TND310/D) for a full description of the naming convention used for image sensors. For reference documentation, including information on evaluation kits, please visit our web site at [www.onsemi.com](http://www.onsemi.com).

# KAF-4320

## DEVICE DESCRIPTION

### Architecture

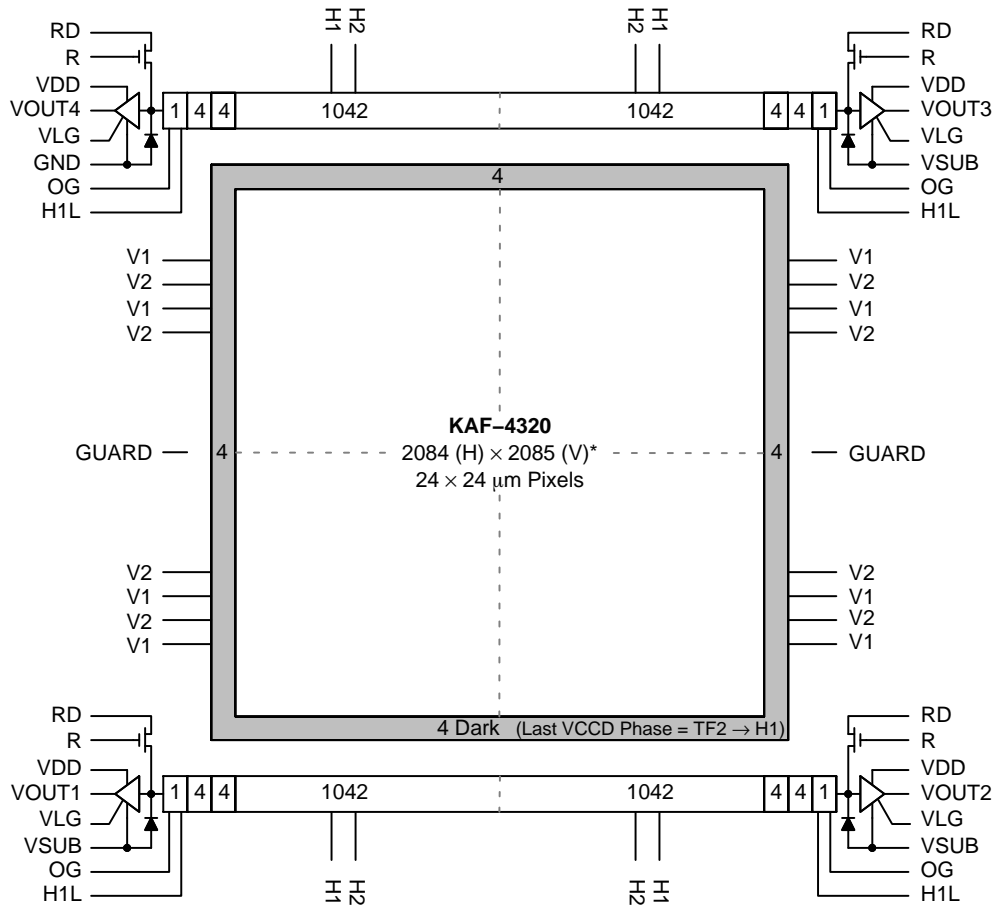

\*The center row is predominately a  $24 \mu\text{m} \times 25 \mu\text{m}$  polysilicon pixel that splits evenly into each half of the array. Thus, each quadrant will consist of  $1046 \text{ (H)} \times 1047 \text{ (V)}$  rows where the last row will contain roughly half the signal.

Figure 2. Block Diagram

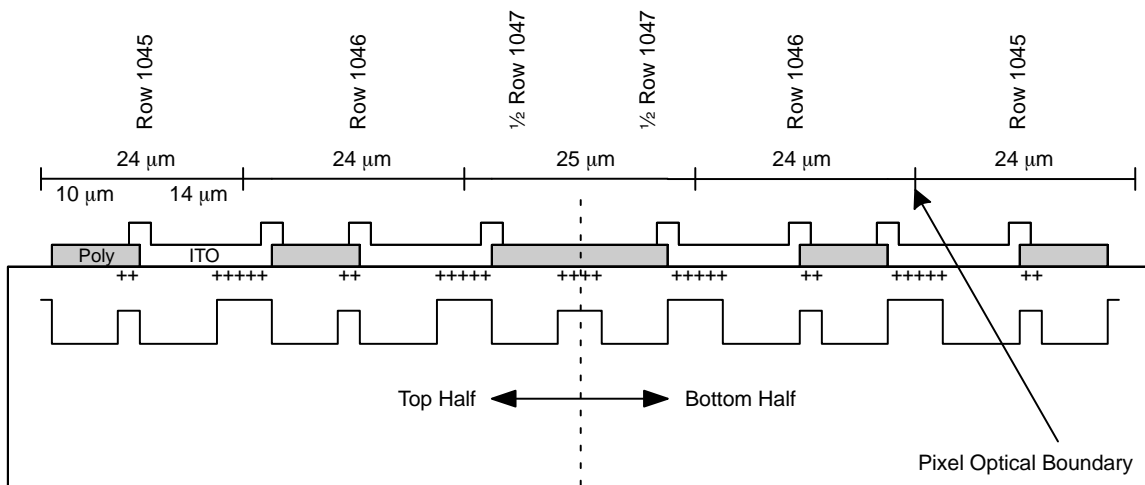

Figure 3. Horizontal Seam Cross-Section

**Image Acquisition**

An electronic representation of an image is formed when incident photons falling on the sensor plane create electron-hole pairs within the sensor. These photon induced electrons are collected locally by the formation of potential wells at each photogate or pixel site. The number of electrons collected is linearly dependent on light level and exposure time and non-linearly dependent on wavelength. When the pixel's capacity is reached, excess electrons will leak into the adjacent pixels within the same column. This is termed blooming. During the integration period, the  $\phi V1$  and  $\phi V2$  register clocks are held at a constant (low) level. See Figure 17.

**Charge Transport**

Referring again to Figure 17, the integrated charge from each photogate is transported to the output using a two-step process. Each line (row) of charge is first transported from the vertical CCD to the horizontal CCD register using the  $\phi V1$  and  $\phi V2$  register clocks. The horizontal CCD is presented a new line on the falling edge of  $\phi V2$  while  $\phi H1$  is held high. The horizontal CCD then transports each line, pixel by pixel, to the output structure by alternately clocking the  $\phi H1$  and  $\phi H2$  pins in a complementary fashion. On each falling edge of  $\phi H1L$  a new charge packet is transferred onto a floating diffusion and sensed by the output amplifier.

*Output Structure*

Charge presented to the floating diffusion is converted into a voltage and current amplified in order to drive off-chip loads. The resulting voltage change seen at the output is linearly related to the amount of charge placed on the

floating diffusion. Once the signal has been sampled by the system electronics, the reset gate ( $\phi R$ ) is clocked to remove the signal and the floating diffusion is reset to the potential applied by  $V_{RD}$ . (See Figure 4). More signal at the floating diffusion reduces the voltage seen at the output pin. In order to activate the output structure, an off-chip load must be added to the  $V_{OUT}$  pin of the device such as shown in Figure 6.

If charge binning is desired, the charge can be combined at the output node or it can be combined in the  $\phi H1L$  gate and then presented to the output node.

*Dark Reference Pixels*

There are 4 light shielded pixels at the beginning of each line. There are 4 dark lines at the start of every frame and 4 dark lines at the end of each frame. Since there are outputs at each of the four corners, the light shield will affect the beginning of each line from each output, and for the first four lines from each of the outputs. Under normal circumstances, these pixels do not respond to light. However, dark reference pixels in close proximity to an active pixel can scavenge signal depending on light intensity and wavelength and therefore will not represent the true dark signal.

*Dummy Pixels*

Within the horizontal shift register are 4-1/2 leading pixels that are not associated with a column of pixels within the vertical register. These pixels contain only horizontal shift register dark current signal and do not respond to light. A few leading dummy pixels may scavenge false signal depending on operating conditions.

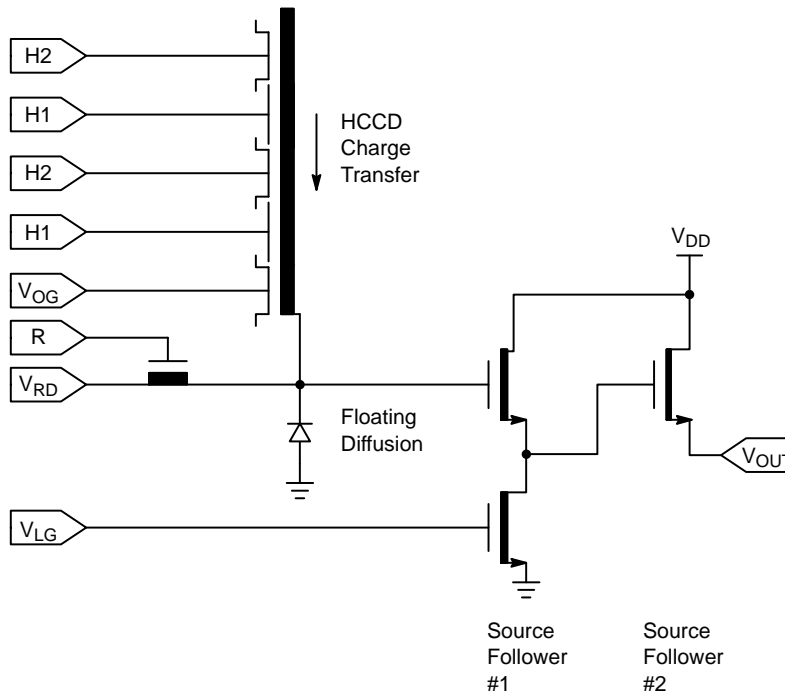

**Figure 4. Output Architecture**

# KAF-4320

## Physical Description

### Pin Description and Device Orientation

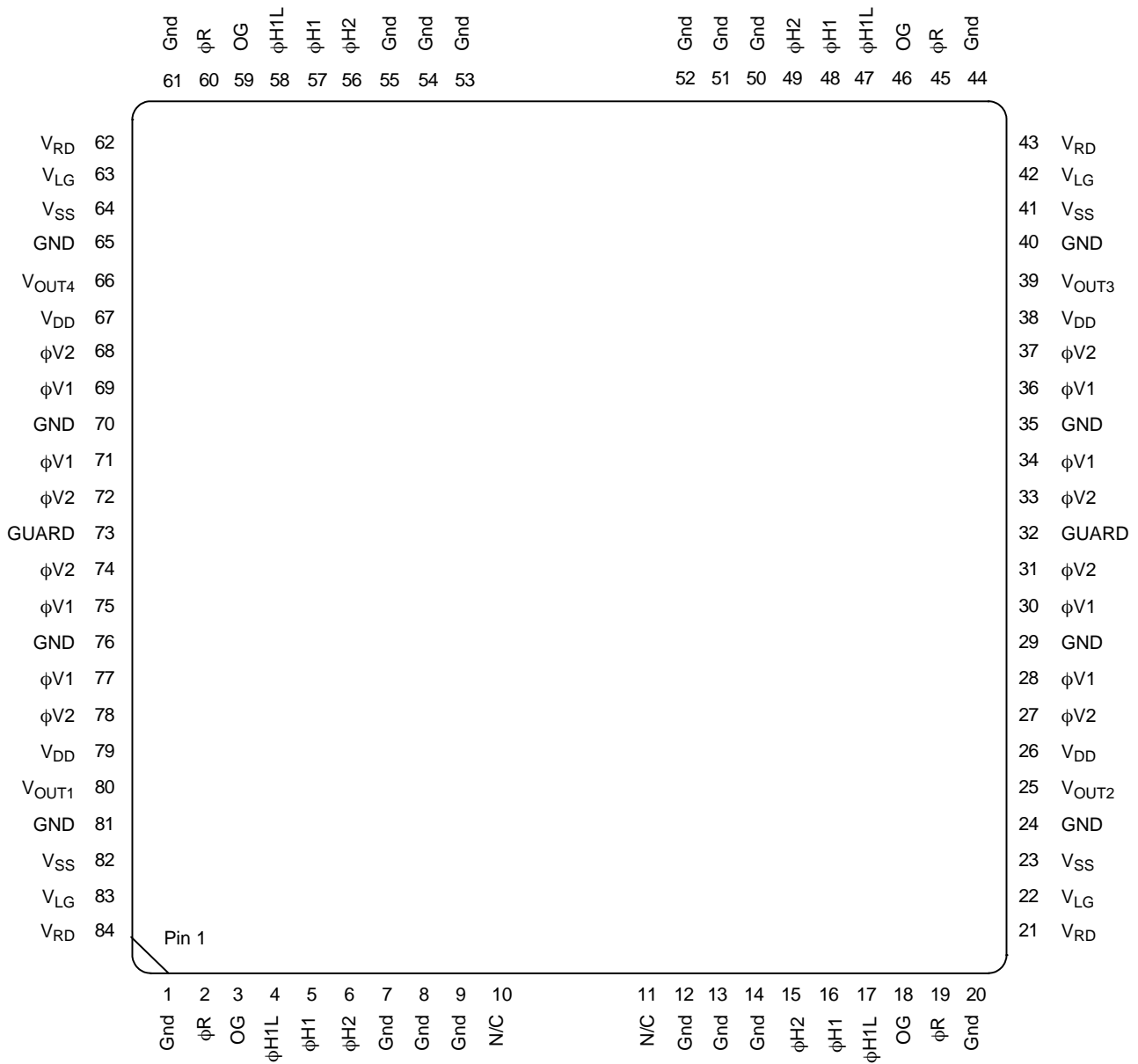

Figure 5. Pinout Diagram

Table 4. PIN DESCRIPTION

Pin	Name	Description
1	GND	Substrate (Ground)
2	$\phi$ R	Reset Clock
3	VOG	Output Gate Bias
4	$\phi$ H1L	Horizontal CCD Clock – Last Phase
5	$\phi$ H1	Horizontal CCD Clock – Phase 1
6	$\phi$ H2	Horizontal CCD Clock – Phase 2
7	GND	Substrate (Ground)
8	GND	Substrate (Ground)
9	GND	Substrate (Ground)
10	N/C	No Connect
11	N/C	No Connect
12	GND	Substrate (Ground)
13	GND	Substrate (Ground)
14	GND	Substrate (Ground)
15	$\phi$ H2	Horizontal CCD Clock – Phase 2
16	$\phi$ H1	Horizontal CCD Clock – Phase 1
17	$\phi$ H1L	Horizontal CCD Clock – Last Phase
18	VOG	Output Gate Bias
19	$\phi$ R	Reset Clock
20	GND	Substrate (Ground)
21	VRD	Reset Drain
22	VLG	Source Follower Load Gate Bias
23	VSS	Amplifier Supply Return
24	GND	Substrate (Ground)
25	VOUT2	Amplifier Output
26	VDD	Amplifier Supply
27	$\phi$ V2	Vertical CCD Clock – Phase 2
28	$\phi$ V1	Vertical CCD Clock – Phase 1
29	GND	Substrate (Ground)
30	$\phi$ V1	Vertical CCD Clock – Phase 1
31	$\phi$ V2	Vertical CCD Clock – Phase 2
32	GUARD	Guard Ring
33	$\phi$ V2	Vertical CCD Clock – Phase 2
34	$\phi$ V1	Vertical CCD Clock – Phase 1
35	GND	Substrate (Ground)
36	$\phi$ V1	Vertical CCD Clock – Phase 1
37	$\phi$ V2	Vertical CCD Clock – Phase 2
38	VDD	Amplifier Supply
39	VOUT3	Amplifier Output
40	GND	Substrate (Ground)
41	VSS	Amplifier Supply Return
42	VLG	Source Follower Load Gate Bias

Pin	Name	Description
43	VRD	Reset Drain
44	GND	Substrate (Ground)
45	$\phi$ R	Reset Clock
46	VOG	Output Gate Bias
47	$\phi$ H1L	Horizontal CCD Clock – Last Phase
48	$\phi$ H1	Horizontal CCD Clock – Phase 1
49	$\phi$ H2	Horizontal CCD Clock – Phase 2
50	GND	Substrate (Ground)
51	GND	Substrate (Ground)
52	GND	Substrate (Ground)
53	GND	Substrate (Ground)
54	GND	Substrate (Ground)
55	GND	Substrate (Ground)
56	$\phi$ H2	Horizontal CCD Clock – Phase 2
57	$\phi$ H1	Horizontal CCD Clock – Phase 1
58	$\phi$ H1L	Horizontal CCD Clock – Last Phase
59	VOG	Output Gate Bias
60	$\phi$ R	Reset Clock
61	GND	Substrate (Ground)
62	VRD	Reset Drain
63	VLG	Source Follower Load Gate Bias
64	VSS	Amplifier Supply Return
65	GND	Substrate (Ground)
66	VOUT4	Amplifier Output
67	VDD	Amplifier Supply
68	$\phi$ V2	Vertical CCD Clock – Phase 2
69	$\phi$ V1	Vertical CCD Clock – Phase 1
70	GND	Substrate (Ground)
71	$\phi$ V1	Vertical CCD Clock – Phase 1
72	$\phi$ V2	Vertical CCD Clock – Phase 2
73	GUARD	Guard Ring
74	$\phi$ V2	Vertical CCD Clock – Phase 2
75	$\phi$ V1	Vertical CCD Clock – Phase 1
76	GND	Substrate (Ground)
77	$\phi$ V1	Vertical CCD Clock – Phase 1
78	$\phi$ V2	Vertical CCD Clock – Phase 2
79	VDD	Amplifier Supply
80	VOUT1	Amplifier Output
81	GND	Substrate (Ground)
82	VSS	Amplifier Supply Return
83	VLG	Source Follower Load Gate Bias
84	VRD	Reset Drain

1. Like named pins (e.g. VSS) should be connected to the same supply.

## IMAGING PERFORMANCE

## Electro-Optical Specifications

All values measured at 25°C, and nominal operating conditions. These parameters exclude defective pixels.

Table 5. SPECIFICATIONS

Description	Symbol	Min.	Nom.	Max.	Units	Notes	Verification Plan
Saturation Signal Vertical CCD Capacity Horizontal CCD Capacity Output Node Capacity	$N_{SAT}$	– – 500,000	650,000 850,000 550,000	– – –	e <sup>-</sup> /pix	1	Design <sup>10</sup>
Quantum Efficiency (see Figure 6)		–	–	–			Design <sup>10</sup>
Photoresponse Non-Linearity	PRNL	–	< 1.0	2.0	%	2	Design <sup>10</sup>
Photoresponse Non-Uniformity	PRNU	–	0.8	2.0	%	3	Design <sup>10</sup>
Channel to Channel Gain Difference	G	–	0.2	5	%	8	Die <sup>9</sup>
Dark Signal	$J_{DARK}$	–	2,507	54,015	e <sup>-</sup> /pix/sec	4	Die <sup>9</sup>
Dark Signal Doubling Temperature		–	6.3	7	°C		Design <sup>10</sup>
Dark Signal Non-Uniformity	DSNU	–	300	540	e <sup>-</sup> /pix/sec	5	Die <sup>9</sup>
Dynamic Range	DR	86	87.5	–	dB	6	Design <sup>10</sup>
Output Amplifier DC Offset	$V_{ODC}$	$V_{RD} - 4$	$V_{RD} - 3$	$V_{RD} - 2$	V		Die <sup>9</sup>
Output Amplifier Sensitivity	$V_{OUT}/N_{e^-}$	9	10	11	μV/e <sup>-</sup>		Design <sup>10</sup>
Output Amplifier Output Impedance	$Z_{OUT}$	–	150	–	Ω		Die <sup>9</sup>
Noise Floor	$n_{e^-}$	–	17	24	electrons	7	Design <sup>10</sup>

1. The maximum output video amplitude limits the charge capacity and dynamic range. The maximum charge capacity is determined from a photon transfer measurement and is defined as the point where the mean-variance fails to demonstrate the theoretical behavior.
2. Worst case deviation from straight line fit, between 0.1% and 95% of  $V_{SAT}$ .
3. One Sigma deviation of a 1042 × 1042 sample (data from one output) when the CCD is illuminated uniformly at half of saturation, excluding defective pixels. [100 · (Std Deviation / Average)]
4. Average of all pixels with no illumination at 25°C.
5. Average dark signal of any of 16 × 16 blocks within the sensor (each block is 130 × 130 pixels).
6. The dynamic range limited by the noise of the output amplifier (i.e. at temperatures less than –10°C), pixel frequency = 3 MHz, and bandwidth = 10 MHz.
7. Noise floor of the CCD amplifier assuming correlated double sampling, pixel frequency = 3 MHz, and bandwidth = 10 MHz.
8.  $\Delta G = \text{abs} (100 \cdot (1 - [\text{response of a channel}] / [\text{average response of all four channels}]))$ . The specified gain difference is the combination of all the gain errors on the CCD sensor and the analog signal processing in the test system.
9. A parameter that is measured on every sensor during production testing.
10. A parameter that is quantified during the design verification activity.

# KAF-4320

## TYPICAL PERFORMANCE CURVES

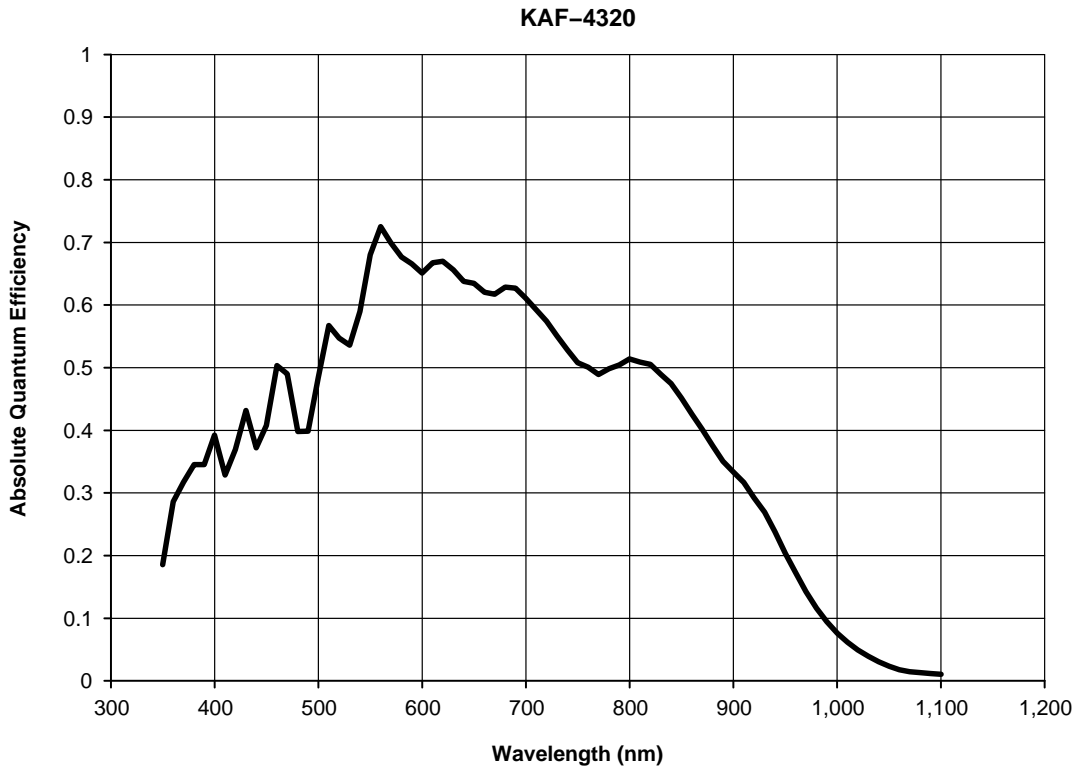

Figure 6. Typical Spectral Response

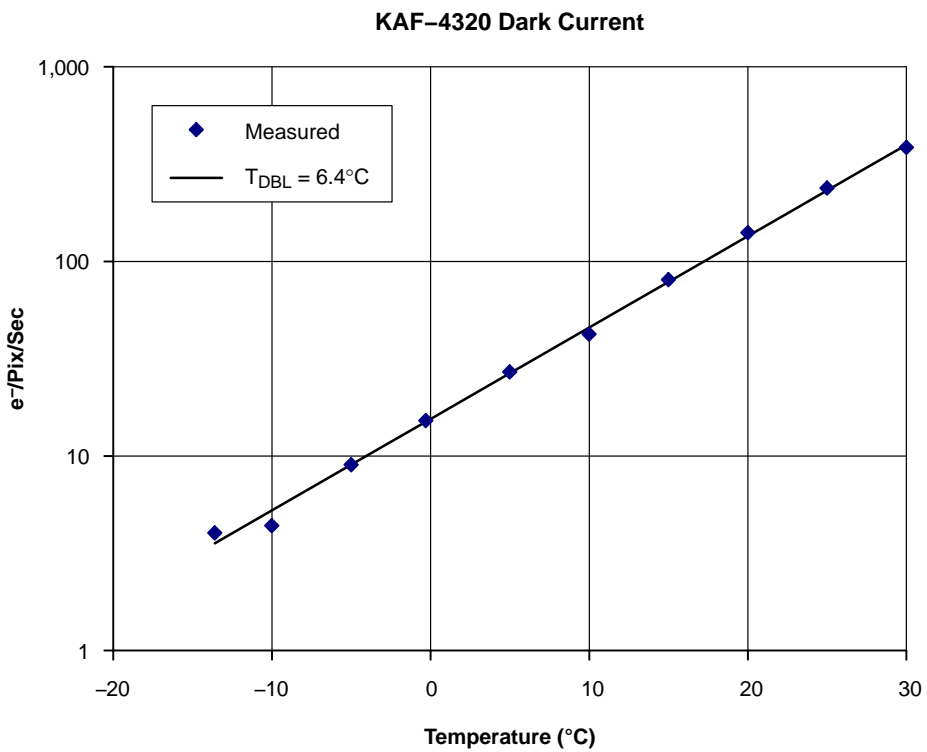

Figure 7. Dark Current Temperature Dependence



**Linearity**

Figure 8 shows a typical result from measuring the signal response as a function of integration time, while the illumination level is constant. The data is fit in log space to give equal weighting between low and high signal levels. A perfectly linear system would have a slope of 1.00 in log

space. The slope in the fit is allowed to deviate from the ideal by a small amount. Typical values of the slope are between 1.00 and 1.02. The deviation from linear is defined as:

$$\% \text{ Dev} = \left| 100 \cdot \frac{[\text{Measured Value} - \text{Fit Value}]}{\text{Fit Value}} \right|$$

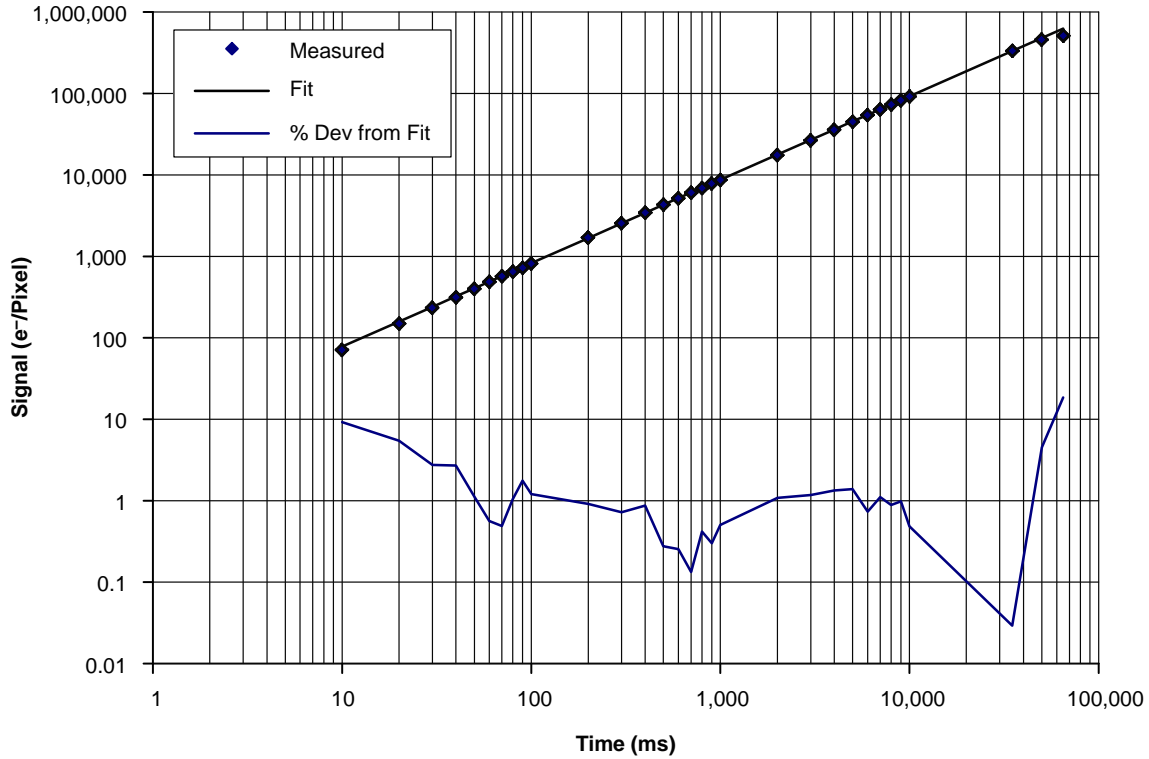
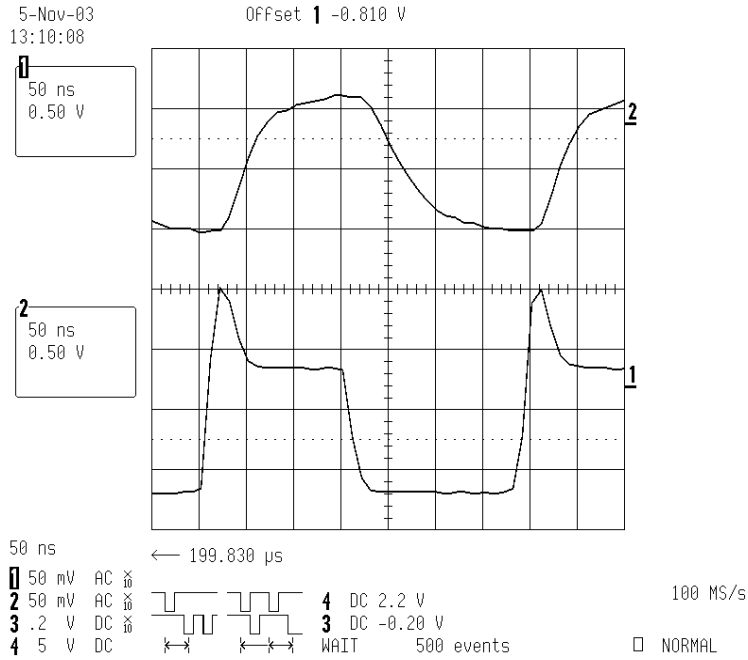

**Figure 8. Linearity**

**CCD Output**

The following figures show typical CCD video at the output of the CCD and at the input of the analog to digital

converter (A/D) in the test system. Bandwidth limiting is applied at the A/D input to minimize the noise floor.



**Figure 9. CCD Output: Small Signal**

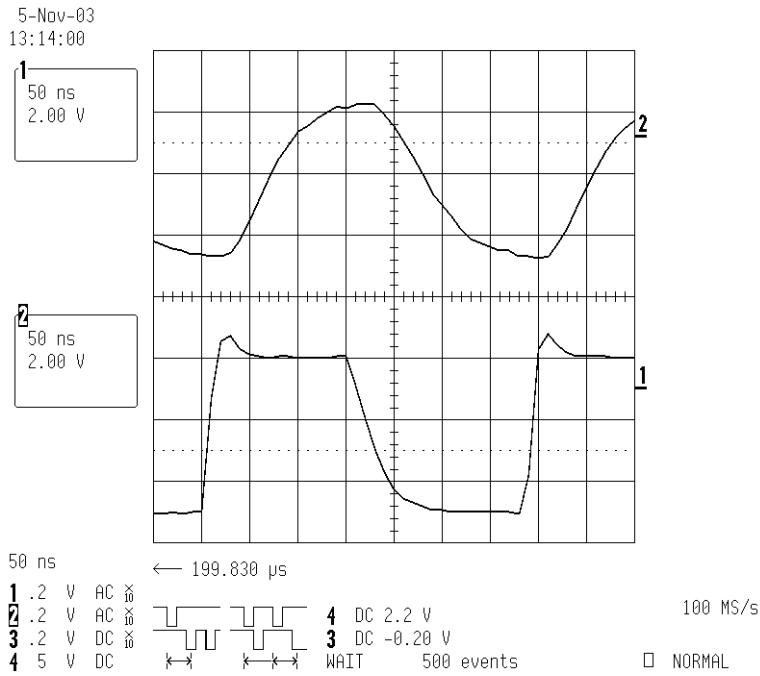

**Figure 10. CCD Output: Large Signal**

**Noise**

The CCD amplifier noise floor, the CCD dark current during readout, and other system components such as the analog-digital converter dictate the total system noise.

*CCD Amplifier*

The noise contributed by the output amplifier is determined from the amplifier’s noise power spectrum, the system bandwidth, and any other analog processing. Correlated double sampling is a standard analog processing technique used with CCDs and it is assumed that it is used for all of the rest of the calculations and results in this document.

*System Noise*

The total noise will be the combination of the CCD noise and the noise contributed by other components in the processing circuitry. The total noise, dominated by the CCD and the A/D converter is also shown in Figure 11. The measured vales were obtained using a system that employed Datel 16 bit analog to digital converters, the ADS931 and ADS933. The system noise obtained matched the Datel specifications exactly and was similar and slightly lower than the CCD noise contribution. The table below shows the results and good agreement

between the expected and measured results for the CCD alone and the CCD in the system at 1 MHz and 3 MHz. The values in the table are in electrons referred to the CCD amplifier input.

**Table 6.**

Frequency	CCD Measured Noise	CCD + System Datel ADS93x Measured
1.00E+06	12	16.2
3.00E+06	17.3	22.6

*Temperature Dependence of the Noise Floor*

The temperature dependence of the noise floor is dictated primarily by the dark current generated during the readout time for the CCD. Figure 12 and Figure 13 show the expected dynamic range as a function of temperature for two pixel rates, 3 MHz and 1 MHz. The dynamic range was calculated using the measured amplifier and system noise values, the expected dark current performance, and the saturation signal. At 25°C, the dark current shot noise can contribute from 12 to 50 electrons and dominate the noise floor. The maximum dynamic range can be achieved at temperatures < -10°C for these read out frequencies.

# KAF-4320

## Noise vs. Frequency

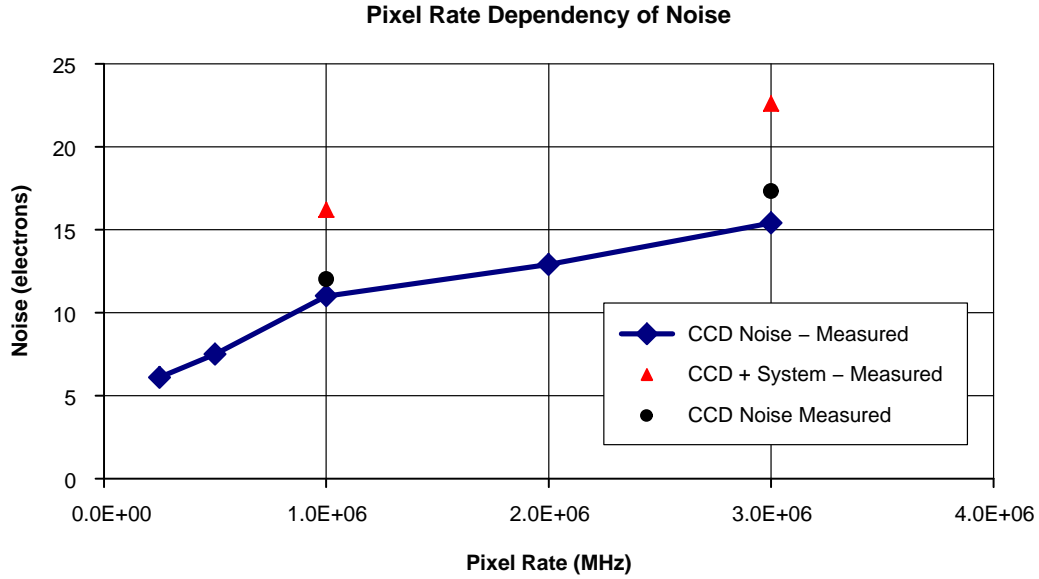
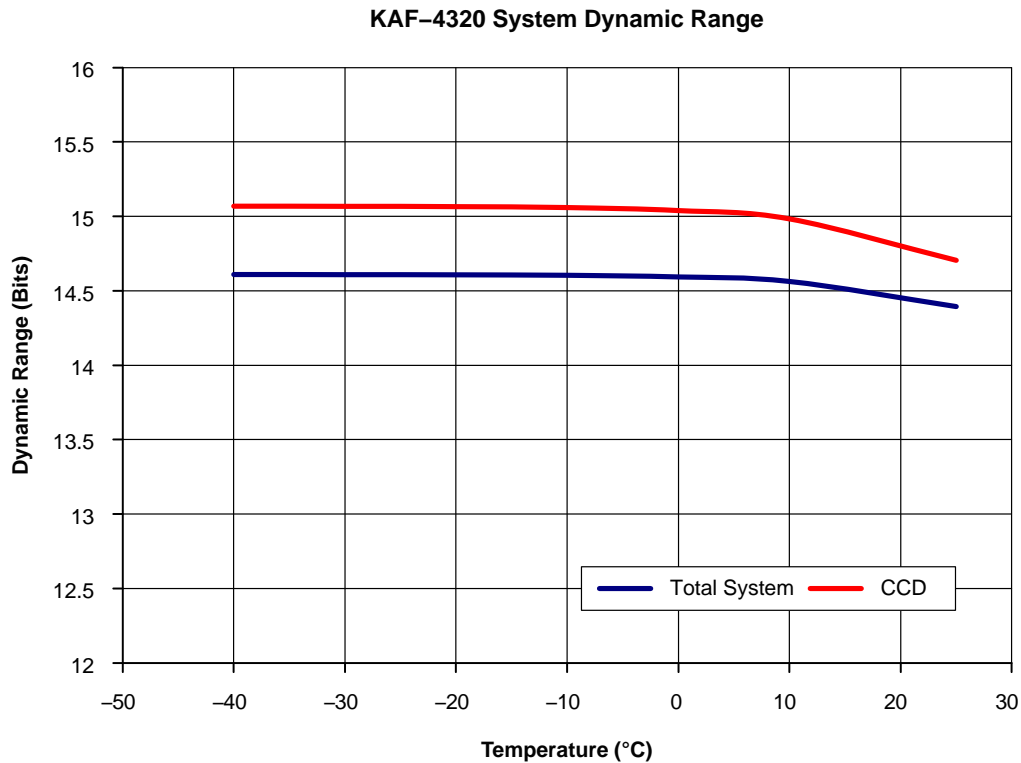

Figure 11. Noise vs. Pixel Rate

## Performance vs. Temperature



Total System Noise: CCD Readout Dark Current + CCD Amplifier + A/D Converter  
(Datel 933 16 Bit Converter)

Figure 12. Noise vs. Temperature – 3 MHz Pixel Rate

# KAF-4320

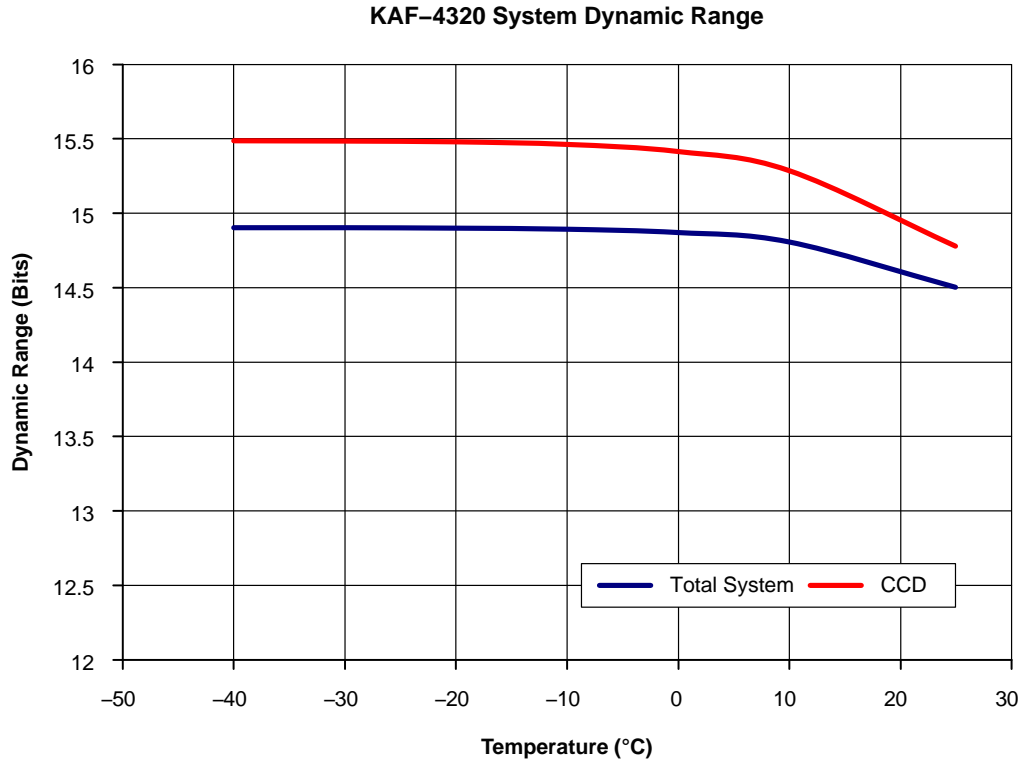

Total System Noise: CCD Readout Dark Current + CCD Amplifier + A/D Converter  
(Datel 933 16 Bit Converter)

**Figure 13. Noise vs. Temperature – 1 MHz Pixel Rate**

**DEFECT DEFINITIONS**

**Table 7. SPECIFICATIONS** (Cosmetic tests performed at T = 25°C)

Grade	Point Defects	Cluster Defects	Columns	Double Columns
C1	< 50	< 20	0	0
C2	< 100	< 20	< 4	0

*Point Defects*

**Dark:** A pixel which deviates by more than 6% from neighboring pixels when illuminated to 70% of saturation.

**Bright:** A pixel with a dark current greater than 5,000 e<sup>-</sup>/pixel/sec at 25°C.

*Cluster Defect*

A grouping of not more than 5 adjacent point defects.

*Column Defect*

A grouping of > 5 contiguous point defects along a single column.

A column containing a pixel with dark current > 100,000 e<sup>-</sup>/pix/sec (Bright column).

A column that does not meet the minimum vertical CCD charge capacity (Low charge capacity column).

A column that loses > 3,500 e<sup>-</sup> under 2 ke<sup>-</sup> illumination (Trap defect).

*Neighboring Pixels*

The surrounding 128 × 128 pixels or ±64 columns/rows.

*Defect Separation*

Column and cluster defects are separated by no less than two (2) pixels in any direction (excluding single pixel defects).

Cluster defects are separated by no less than 2 pixels from other column and cluster defects.

Column defects are separated by no less than 5 pixels from other column defects.

**OPERATION**

**Table 8. ABSOLUTE MAXIMUM RATINGS**

Description	Symbol	Minimum	Maximum	Units	Notes
Diode Pin Voltages	$V_{DIODE}$	0	25	V	1, 2
Gate Pin Voltages – Type 1	$V_{GATE1}$	-17	17	V	1, 3, 6
Gate Pin Voltages – Type 2	$V_{GATE2}$	0	17	V	1, 4, 6
Output Bias Current	$I_{OUT}$	-	-10	mA	5
Output Load Capacitance	$C_{LOAD}$	-	15	pF	5

Stresses exceeding those listed in the Maximum Ratings table may damage the device. If any of these limits are exceeded, device functionality should not be assumed, damage may occur and reliability may be affected.

1. Referenced to pin VSUB or between each pin in this group.
2. Includes pins: VRD, VDD, VSS, VOUT.
3. Includes pins:  $\phi V1$ ,  $\phi V2$ ,  $\phi H1$ ,  $\phi H2$ ,  $\phi H1L$ .
4. Includes pins: VOG, VLG,  $\phi R$ .
5. Avoid shorting output pins to ground or any low impedance source during operation.
6. This sensor contains gate protection circuits to provide protection against ESD events. The circuits will turn on when greater than 18 volts appears between any two gate pins. Permanent damage can result if excessive current is allowed to flow under these conditions.

**Equivalent Input Circuits**

Many of the pins contain a form of gate protection to prevent damage from electrostatic discharge. These take the form of zener diodes that prevent the voltage differences

between gates from becoming large enough to damage the sensor. Isolated gates such as  $\phi R$  and  $V_{LG}$  require only protection between the gate and the sensor substrate.

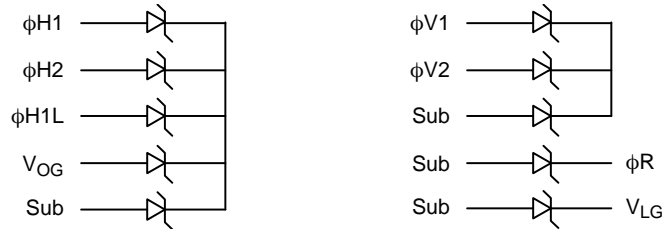

**Figure 14. Equivalent Input Circuits**

Table 9. DC BIAS OPERATING CONDITIONS

Description	Symbol	Minimum	Nominal	Maximum	Units	Maximum DC Current (mA)	Notes
Reset Drain	$V_{RD}$	-	18.5	-	V	0.01	2
Output Amplifier Return	$V_{SS}$	-	2.0	-	V	1	3
Output Amplifier Supply	$V_{DD}$	-	21	-	V	$I_{OUT}$	2
Substrate	GND	-	0	-	V	-	
Output Gate	$V_{OG}$	-	0	-	V	0.01	3
Output Amplifier Load Gate	$V_{LG}$	$V_{SS}$	$V_{SS} + 1.0$	$V_{SS} + 1.2$	V	0.01	
Guard Ring	GUARD	-	10	-	V	-	3
Amplifier Output Current	$I_{OUT}$	-	-5	-10	mA	-	1

1. An output load sink must be applied to  $V_{OUT}$  to provide a constant current source and activate the output amplifier – see Figure 15.
2. Voltage tolerance is 2% (actual voltage should be nominal  $\pm$  tolerance).
3. Voltage tolerance is 5% (actual voltage should be nominal  $\pm$  tolerance).

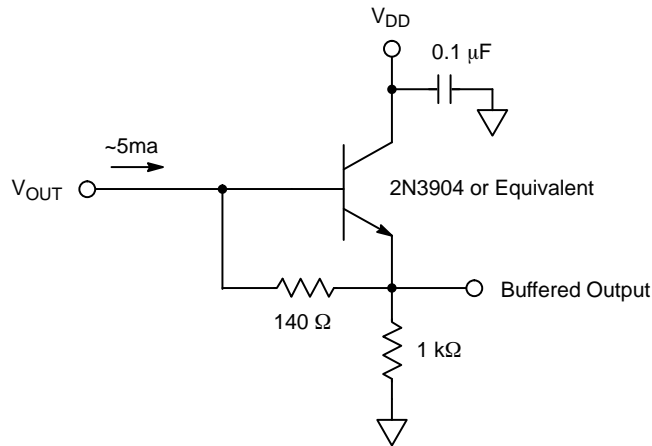

Figure 15. Example Output Structure Load Diagram



## AC Operating Conditions

Table 10. CLOCK LEVELS

Description	Symbol	Level	Nominal	Units	Effective Capacitance	Notes
Vertical CCD Clock – Phase 1	$\phi V1$	Low	-8.0	V	75 nF (Each of $\phi V1$ Pins 30, 34, 71, 75)	4, 5
		Clock Amplitude	8.0			
Vertical CCD Clock – Phase 2	$\phi V2$	Low	-8.0	V	75 nF (Each of $\phi V2$ Pins 31, 33, 72, 74)	4, 5
		Clock Amplitude	8.0			
Horizontal CCD Clock – Phase 1	$\phi H1$	Low	0	V	150 nF (Each of $\phi H1$ Pins 5, 16, 48, 57)	3, 6
		Clock Amplitude	10.0			
Horizontal CCD Clock – Last Gate	$\phi H1L$	Low	-3.0	V	10 pF	3
		Clock Amplitude	10.0			
Horizontal CCD Clock – Phase 2	$\phi H2$	Low	-3.0	V	100 pF	3, 7
		Clock Amplitude	10.0			
Reset Clock	$\phi R$	Low	2.0	V	5 pF	3
		Clock Amplitude	12.0			

1. All pins draw less than 10  $\mu A$  DC current.
2. Capacitance values relative to  $V_{SUB}$ .
3. Voltage tolerance is 2% (actual voltage should be nominal  $\pm$  tolerance).
4. Voltage tolerance is 5% (actual voltage should be nominal  $\pm$  tolerance).
5. Total clock capacitance is  $4 \cdot 75 \text{ nF} = 300 \text{ nF}$ .
6. Total clock capacitance is  $4 \cdot 150 \text{ pF} = 600 \text{ pF}$ .
7. Total clock capacitance is  $4 \cdot 100 \text{ pF} = 400 \text{ pF}$ .

## AC Timing Conditions

Table 11. AC TIMING CONDITIONS

Description	Symbol	Minimum	Nominal	Maximum	Units	Notes
$\phi H1$ , $\phi H2$ Clock Frequency	$f_H$	–	3	3	MHz	1, 2, 3
Pixel Period (1 Count)	$t_e$	333	333	–	ns	
$\phi H1$ , $\phi H2$ Set-up Time	$t_{\phi HS}$	10	10	–	$\mu s$	
$\phi V1$ , $\phi V2$ Clock Pulse Width	$t_{\phi V}$	30	30	–	$\mu s$	2
Reset Clock Pulse Width	$t_{\phi R}$	–	20	–	ns	4
Readout Time	$t_{READOUT}$	470.3	470.3	–	ms	5
Integration Time	$t_{INT}$	–	–	–		6
Line Time	$t_{LINE}$	449.6	449.6	–	$\mu s$	7

1. 50% duty cycle values.
2. CTE may degrade above the nominal frequency.
3. Rise and fall times (10/90% levels) should be limited to 5–10% of clock period. Crossover of register clocks should be between 40–60% of amplitude.
4.  $\phi R$  should be clocked continuously.
5.  $t_{READOUT} = (1046 \cdot t_{LINE})$
6. Integration time ( $t_{INT}$ ) is user specified. Longer integration times will degrade noise performance due to dark signal fixed pattern and shot noise.
7.  $t_{LINE} = (3 \cdot t_{\phi V}) + t_{\phi HS} + (1050 \cdot t_e)$ .
8. When combining the image from the upper half of the device with that from the lower half, line 1047 from each must be added together and gained (approx. 1.2X) to match the other 1046 lines.

Pixel Rate Clock Waveforms

For best performance, the horizontal clocks should be damped, similar to those shown in Figure 16. The clocks in

this figure were generated using a 50 Ω output impedance clock driver. Excessively fast clocks can result in a higher noise floor.

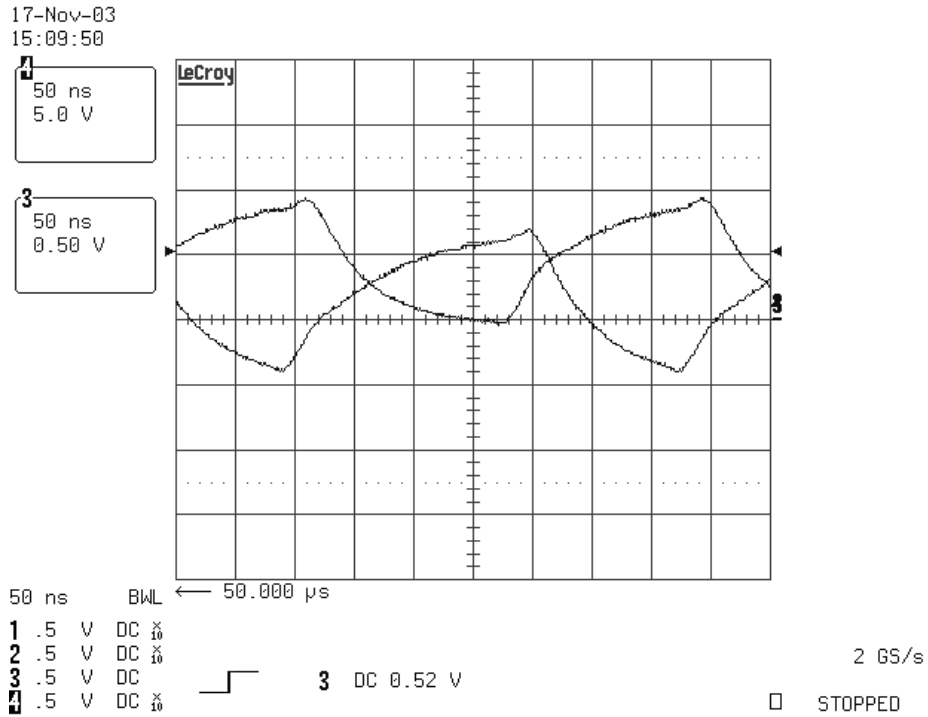
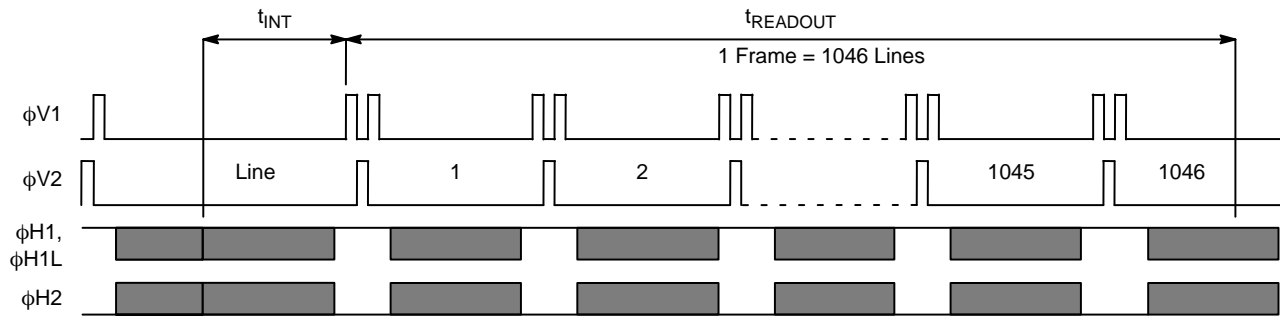

Figure 16. Clock Example

**TIMING**

**Normal Read Out**

**Frame Timing – per Quadrant (Each Output Contains One Half of the Line)**



**Line Timing**

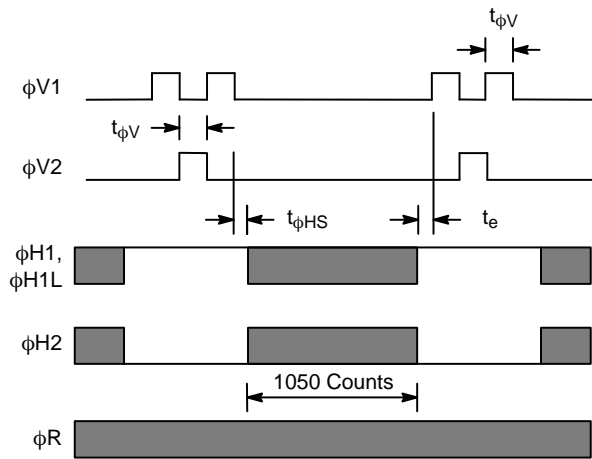

**Pixel Timing**

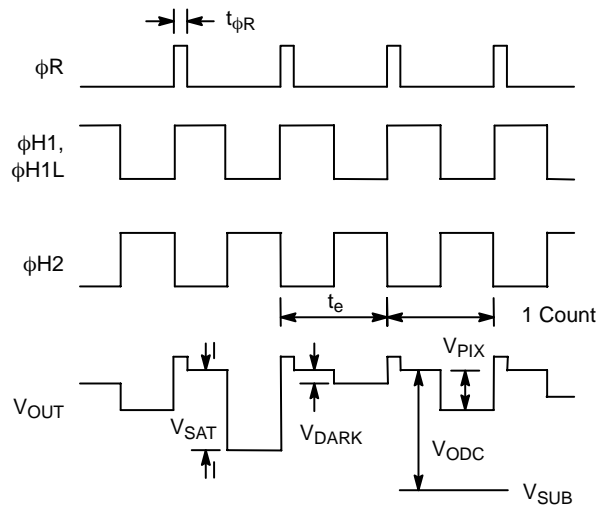

**Line Content – per Quadrant (Each Output Contains One Half of the Line)**

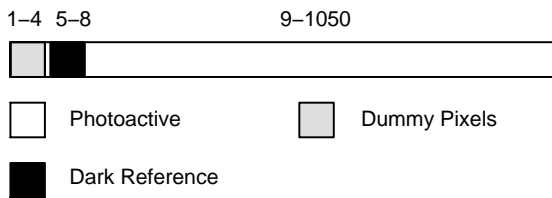

- $V_{SAT}$  Saturated pixel video output
- $V_{DARK}$  Video output signal in no-light situation (not zero due to  $J_{DARK}$  and  $H_{CLOCK}$  feedthrough)
- $V_{PIX}$  Pixel video output signal level, more electrons = more positive\*
- $V_{ODC}$  Video level offset with respect to  $V_{SUB}$
- $V_{SUB}$  Analog ground

\* See Image Acquisition section.

**Figure 17. Timing Diagrams**

**Power Dissipation**

The power dissipated by the CCD clocks is calculated using the formula:

$$\text{Power} = C \cdot V^2 \cdot f$$

Where C is the capacitance in farads, V is the clock amplitude in volts, and f is the frequency in Hz.

*Amplifier Power*

The power dissipated by amplifiers is calculated by  $\text{Power} = I \cdot V$  where I is the current and V is the voltage drop on the CCD. The sensor contains two stage source followers. The first stage draws approximately 250 micro amps and the

voltage drop is  $V_{DD} - V_{SS}$ . The second stage sources much more current, approximately 5 mA while the voltage drop on the sensor is much smaller,  $V_{DD} - V_{OUT}$  where  $V_{OUT} \sim V_{RD}$ .

*Total Power*

The table below shows the power dissipated at three different pixel frequencies. For each of these cases the amplifier operating conditions are held constant so its contribution is not frequency dependent. The time for the vertical clock transfers is also held constant (90 microseconds per line) but the line time changes depending on the pixel rate.

**Table 12. TOTAL POWER**

Contributor	Pixel Rate			Notes
	500 kHz	1 MHz	3 MHz	
Amplifiers	120 mW	120 mW	120 mW	Total of 4 Outputs
HCCD	60 mW	120 mW	360 mW	
VCCD	62 mW	121 mW	297 mW	
Total	241 mW	361 mW	776 mW	

*CCD Surface Flatness*

The flatness of the die is defined as a peak-to-peak distortion in the image sensor surface. The parallelism between the image sensor surface and any of the package

components is not specified or guaranteed. The non-parallelism is removed when measuring the distortion in the image sensor surface.

**Table 13.**

		Minimum	Nominal	Maximum	Unit
Die Flatness	Peak-to-Peak Distortion	-	8.8	12.0	microns

Some examples of profiles of some typical image sensors surfaces are shown below.

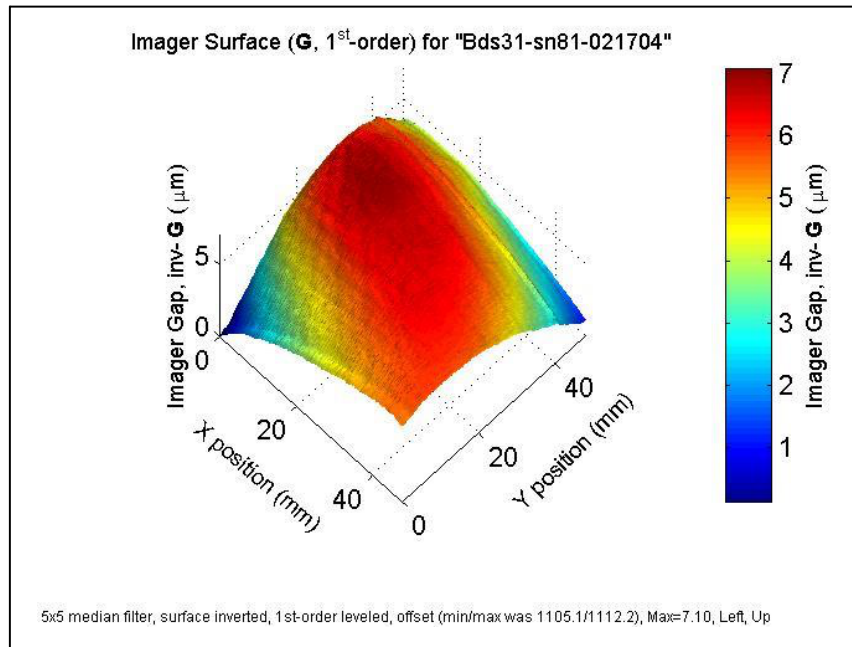

**Figure 18. Die Flatness Data**

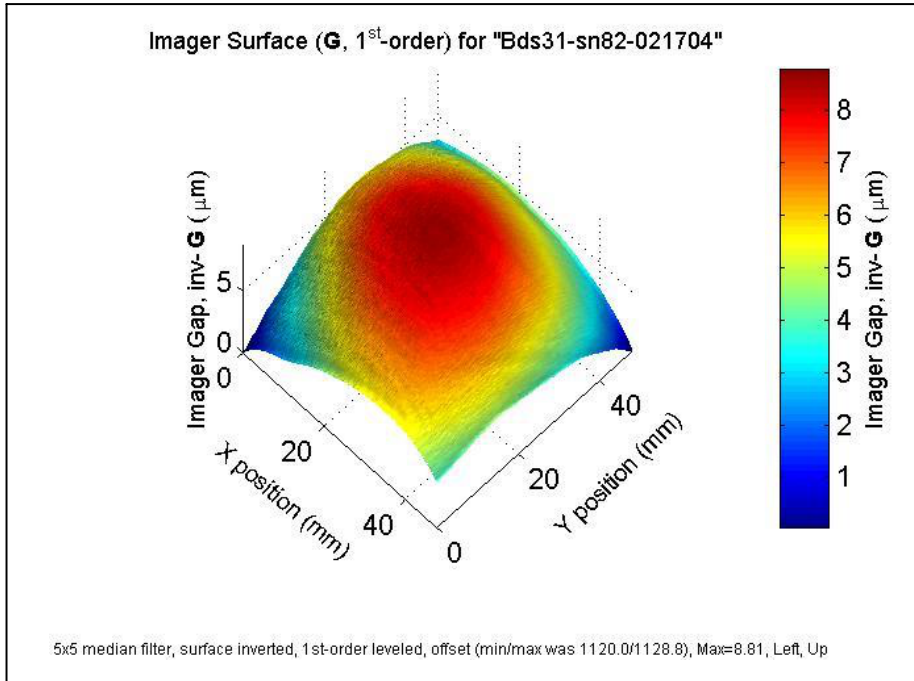

Figure 19. Die Flatness Data

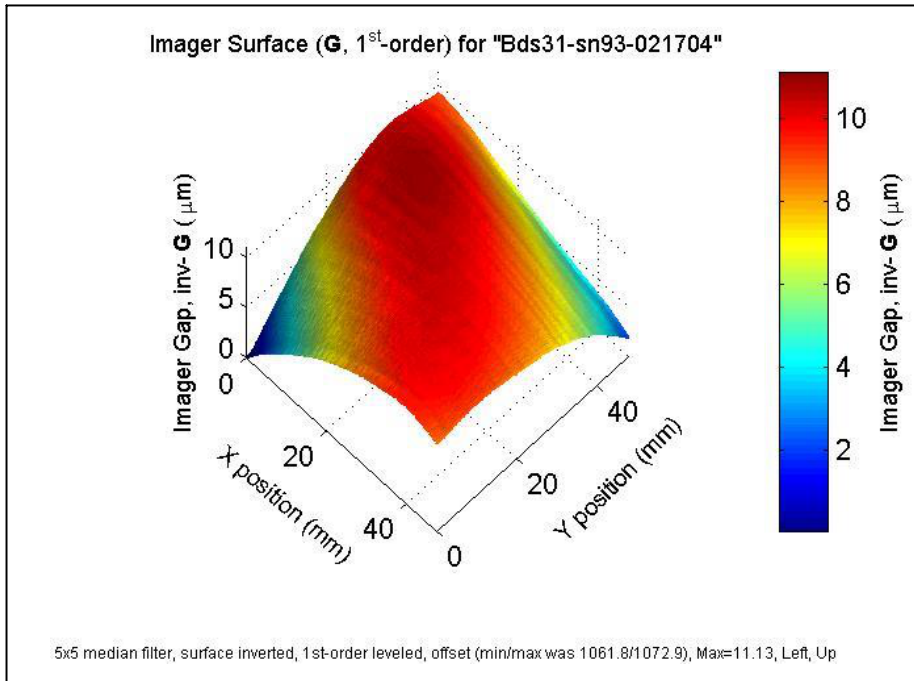

Figure 20. Die Flatness Data

## STORAGE AND HANDLING

Table 14. STORAGE CONDITIONS

Description	Symbol	Minimum	Maximum	Units	Notes
Storage Temperature	T <sub>ST</sub>	-100	80	°C	1
Operating Temperature	T <sub>OP</sub>	-70	50	°C	

1. Image sensors with temporary cover glass should be stored at room temperature (nominally 25°C) in dry nitrogen.

For information on ESD and cover glass care and cleanliness, please download the *Image Sensor Handling and Best Practices* Application Note (AN52561/D) from [www.onsemi.com](http://www.onsemi.com).

For information on soldering recommendations, please download the *Soldering and Mounting Techniques Reference Manual* (SOLDERRM/D) from [www.onsemi.com](http://www.onsemi.com).

For quality and reliability information, please download the *Quality & Reliability Handbook* (HBD851/D) from [www.onsemi.com](http://www.onsemi.com).

For information on device numbering and ordering codes, please download the *Device Nomenclature* technical note (TND310/D) from [www.onsemi.com](http://www.onsemi.com).

For information on Standard terms and Conditions of Sale, please download [Terms and Conditions](http://www.onsemi.com) from [www.onsemi.com](http://www.onsemi.com).

MECHANICAL INFORMATION

Completed Assembly

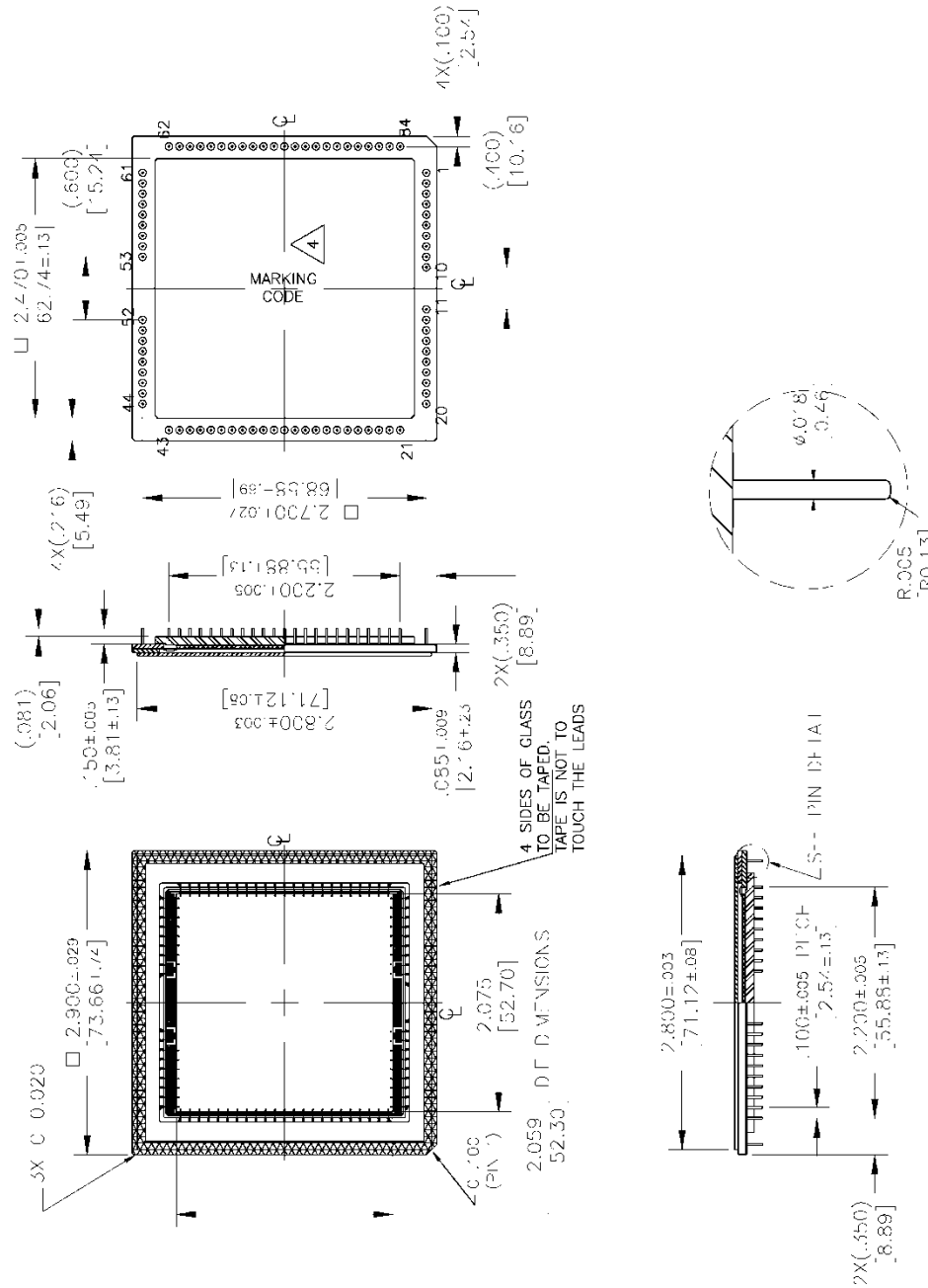

Figure 21. Completed Assembly (1 of 2)

KAF-4320

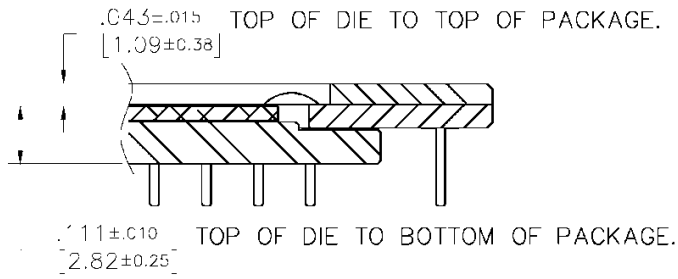
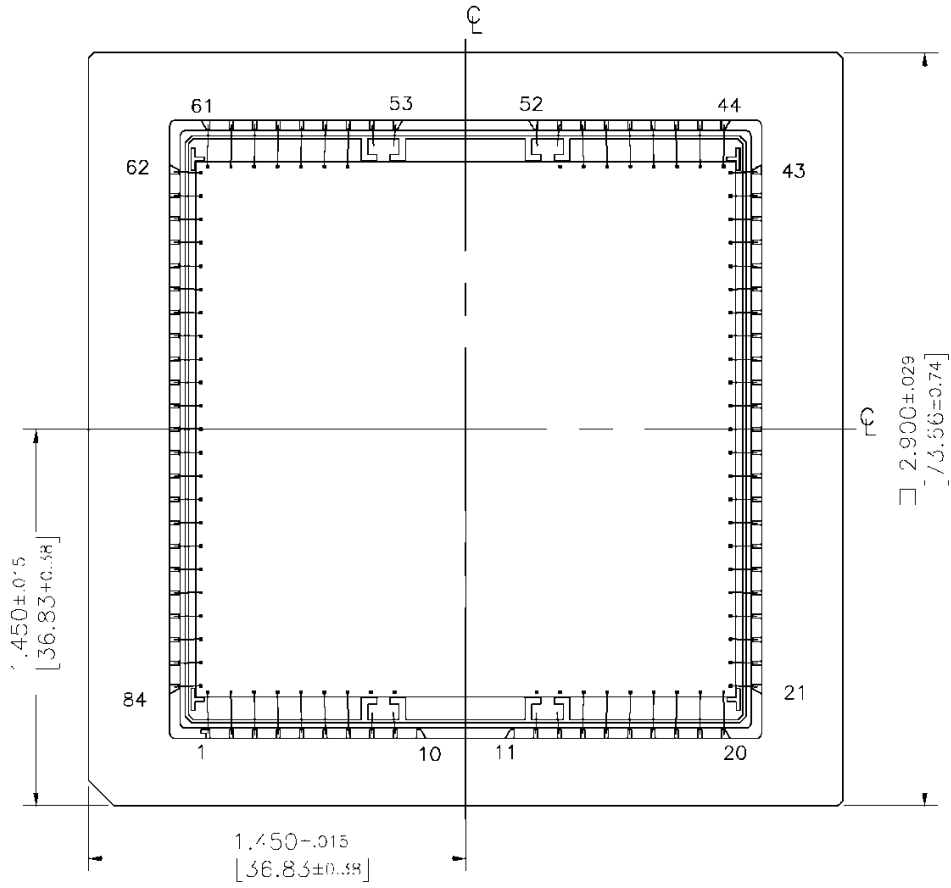



Figure 22. Completed Assembly (2 of 2)



ON Semiconductor and the  are registered trademarks of Semiconductor Components Industries, LLC (SCILLC) or its subsidiaries in the United States and/or other countries. SCILLC owns the rights to a number of patents, trademarks, copyrights, trade secrets, and other intellectual property. A listing of SCILLC's product/patent coverage may be accessed at [www.onsemi.com/site/pdf/Patent-Marking.pdf](http://www.onsemi.com/site/pdf/Patent-Marking.pdf). SCILLC reserves the right to make changes without further notice to any products herein. SCILLC makes no warranty, representation or guarantee regarding the suitability of its products for any particular purpose, nor does SCILLC assume any liability arising out of the application or use of any product or circuit, and specifically disclaims any and all liability, including without limitation special, consequential or incidental damages. "Typical" parameters which may be provided in SCILLC data sheets and/or specifications can and do vary in different applications and actual performance may vary over time. All operating parameters, including "Typicals" must be validated for each customer application by customer's technical experts. SCILLC does not convey any license under its patent rights nor the rights of others. SCILLC products are not designed, intended, or authorized for use as components in systems intended for surgical implant into the body, or other applications intended to support or sustain life, or for any other application in which the failure of the SCILLC product could create a situation where personal injury or death may occur. Should Buyer purchase or use SCILLC products for any such unintended or unauthorized application, Buyer shall indemnify and hold SCILLC and its officers, employees, subsidiaries, affiliates, and distributors harmless against all claims, costs, damages, and expenses, and reasonable attorney fees arising out of, directly or indirectly, any claim of personal injury or death associated with such unintended or unauthorized use, even if such claim alleges that SCILLC was negligent regarding the design or manufacture of the part. SCILLC is an Equal Opportunity/Affirmative Action Employer. This literature is subject to all applicable copyright laws and is not for resale in any manner.

## PUBLICATION ORDERING INFORMATION

### LITERATURE FULFILLMENT:

Literature Distribution Center for ON Semiconductor  
P.O. Box 5163, Denver, Colorado 80217 USA  
**Phone:** 303-675-2175 or 800-344-3860 Toll Free USA/Canada  
**Fax:** 303-675-2176 or 800-344-3867 Toll Free USA/Canada  
**Email:** [orderlit@onsemi.com](mailto:orderlit@onsemi.com)

**N. American Technical Support:** 800-282-9855 Toll Free  
USA/Canada  
**Europe, Middle East and Africa Technical Support:**  
Phone: 421 33 790 2910  
**Japan Customer Focus Center**  
Phone: 81-3-5817-1050

**ON Semiconductor Website:** [www.onsemi.com](http://www.onsemi.com)  
**Order Literature:** <http://www.onsemi.com/orderlit>  
For additional information, please contact your local  
Sales Representative