

PRODUCT SPECIFICATION

DATE : 03/01/2005

cosmo ELECTRONICS CORPORATION	SOLID STATE RELAY - MOSFET OUTPUT KAQW216H	Preliminary	REV.
		SHEET 1 OF 7	0

● OUTSIDE DIMENSION :

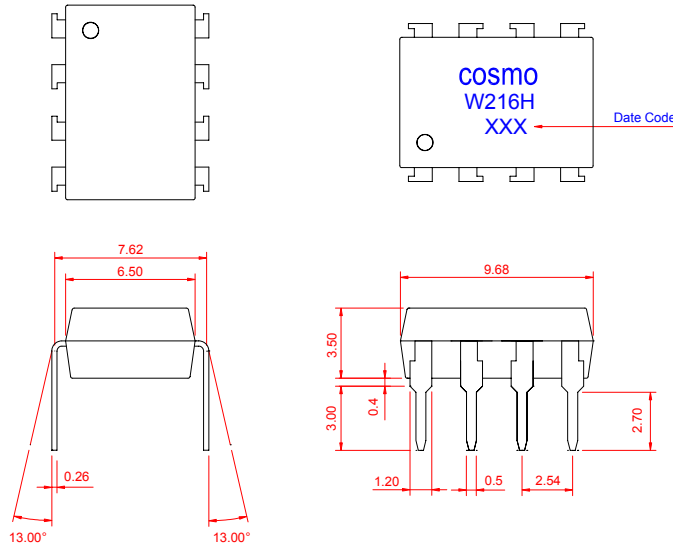

Unit : mm
Tolerance : $\pm 0.2\text{mm}$

● Turn On / Turn Off time

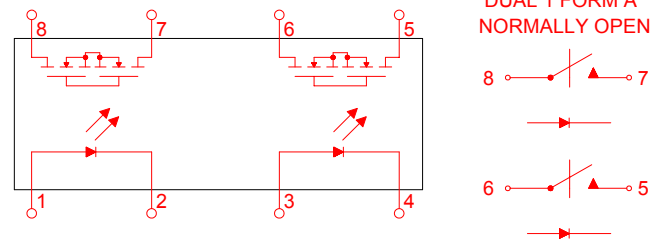
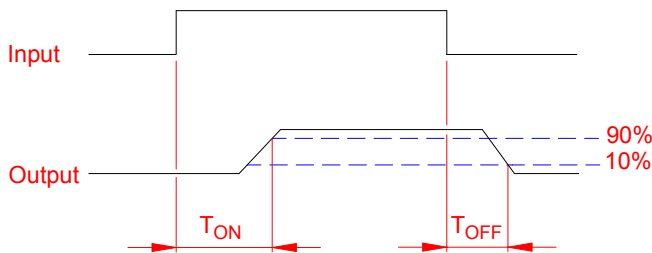

● Absolute Maximum Ratings

($T_a=25^\circ\text{C}$)

Emitter (Input)	Detector (Output)
Reverse Voltage 5.0V	Output Breakdown Voltage $\pm 600\text{V}$
Continuous Forward Current 50mA	Continuous Load Current $\pm 120\text{mA}$
Peak Forward Current 1A	Power Dissipation 500mW
Power Dissipation 100mW	
Derate Linearly from 25°C 1.3mW/ $^\circ\text{C}$	
General Characteristics	
Isolation Test Voltage 5000VACrms	Storage Temperature Range -40°C to $+125^\circ\text{C}$
Isolation Resistance	Operating Temperature Range ... -40°C to $+85^\circ\text{C}$
$V_{io}=500\text{V}$, $T_a=25^\circ\text{C}$ $\geq 10^{10}\Omega$	Junction Temperature 100°C
Total Power Dissipation 550mW	Soldering Temperature ,
Derate Linearly from 25°C 2.5mW/ $^\circ\text{C}$	2mm from case , 10 sec 260°C

PRODUCT SPECIFICATION

DATE : 03/01/2005

cosmo ELECTRONICS CORPORATION	SOLID STATE RELAY - MOSFET OUTPUT KAQW216H	Preliminary	REV. 0
		SHEET 2 OF 7	

● Electro-optical Characteristics

(Ta=25°C)

Parameter	Symbol	Conditions	Min.	Typ.	Max.	Unit.
Emitter (Input)						
Forward Voltage	V_F	$I_F=10\text{mA}$		1.2	1.5	V
Operation Input Current	$I_{F\text{ON}}$	$V_L=\pm 20\text{V}$, $I_L=100\text{mA}$, $t=10\text{ms}$			5.0	mA
Recovery Input Current	$I_{F\text{OFF}}$	$V_L=\pm 20\text{V}$, $I_L \leq 5\mu\text{A}$	0.2			mA
Detector (Output)						
Output Breakdown Voltage	V_B	$I_B=50\mu\text{A}$	600			V
Output Off-State Leakage	$I_{T\text{OFF}}$	$V_T=100\text{V}$, $I_F=0\text{mA}$		0.2	1	μA
I/O Capacitance	C_{ISO}	$I_F=0$, $f=1\text{MHz}$		6		pF
ON Resistance	R_{ON}	$I_L=100\text{mA}$, $I_F=10\text{mA}$		35	50	Ω
Turn-On Time	T_{ON}	$I_F=10\text{mA}$, $V_L=\pm 20\text{V}$ $t=10\text{ms}$, $I_L=\pm 100\text{mA}$		0.3	1.0	ms
Turn-Off Time	T_{OFF}			0.7	1.5	ms

● Schematic and Wiring Diagrams

Schematic	Output Configuration	Load	Connection	Wiring Diagrams
	2a	AC/DC	-	<p>(1) Two Independent 1 Form A use</p> <p>(2) 2 Form A use</p>

PRODUCT SPECIFICATION

DATE : 03/01/2005

cosmo ELECTRONICS CORPORATION	SOLID STATE RELAY - MOSFET OUTPUT KAQW216H	Preliminary	REV.
		SHEET 3 OF 7	0

● Data Curve

Load current vs. ambient temperature
 Allowable ambient Temperature :
 -40°C to +85°C

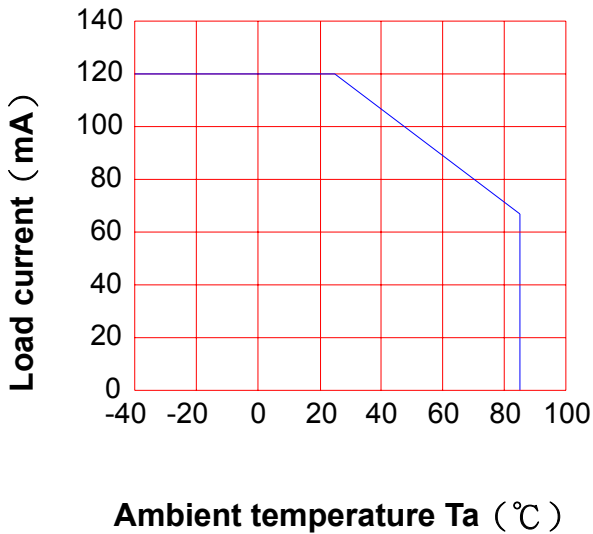

On resistance vs. ambient temperature
 across terminals 5,7 and 6,8 pin
 LED current : 5mA
 Continuous load current : 120mA (DC)

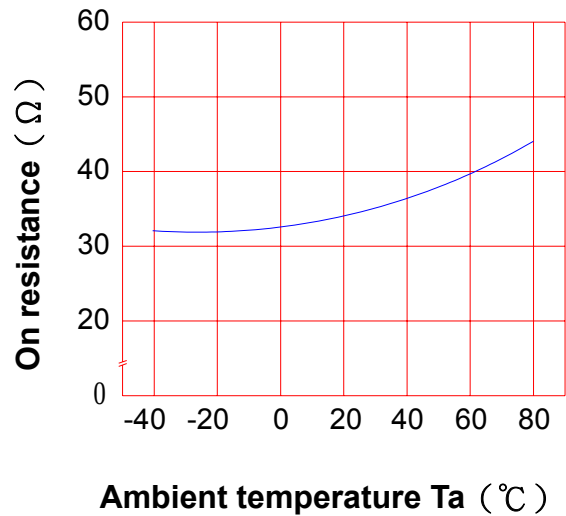

Turn On Time vs. ambient temperature
 Load voltage 600V (DC)
 LED current : 5mA
 Continuous load current : 120mA (DC)

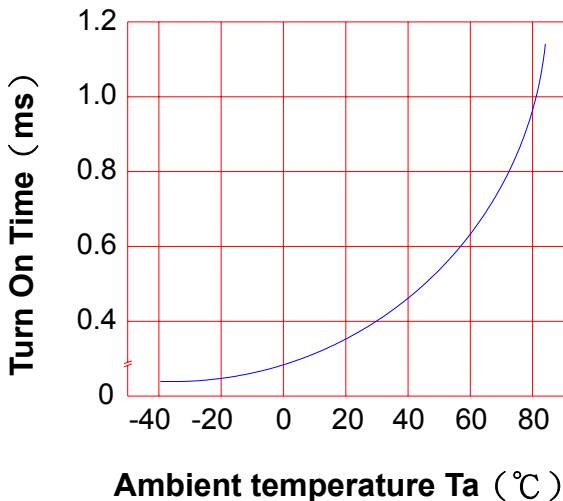

Turn Off Time vs. ambient temperature
 Load voltage 600V (DC)
 LED current : 5mA
 Continuous load current : 120mA (DC)

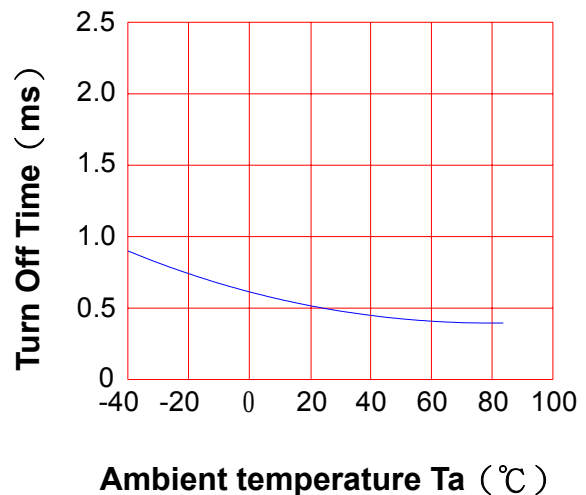

PRODUCT SPECIFICATION

DATE : 03/01/2005

cosmo ELECTRONICS CORPORATION	SOLID STATE RELAY - MOSFET OUTPUT KAQW216H	Preliminary	REV.
		SHEET 4 OF 7	0

LED operate current vs.
ambient temperature
Load Voltage : 600V (DC)
Continuous load current : 120mA (DC)

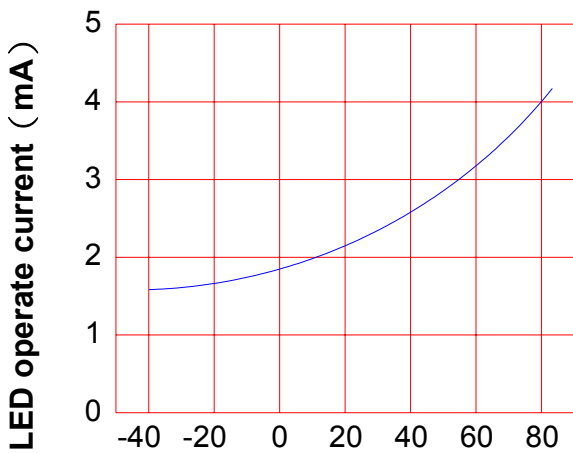

Ambient temperature Ta (°C)

LED Turn Off current vs.
ambient temperature
Load Voltage : 600V (DC)
Continuous load current : 120mA (DC)

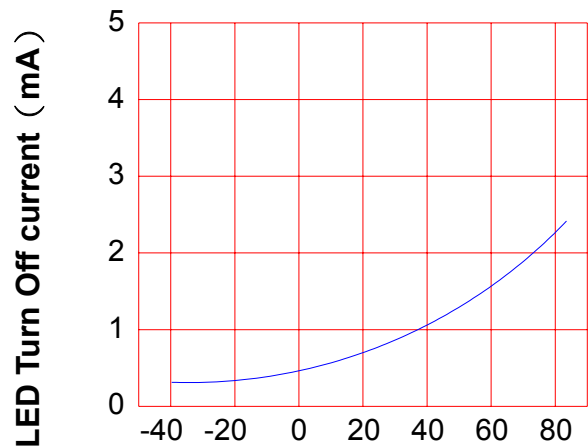

Ambient temperature Ta (°C)

LED dropout voltage vs.
ambient temperature
LED current : 5 to 50mA

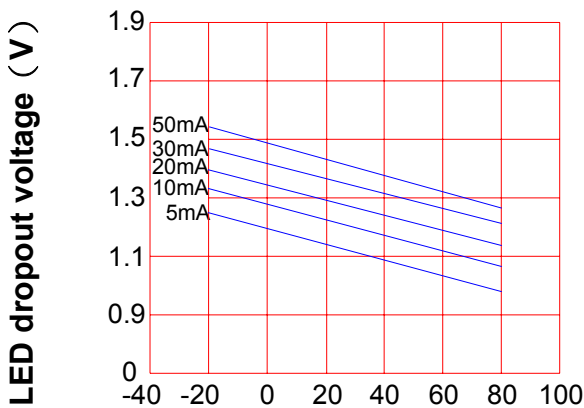

Ambient temperature Ta (°C)

Voltage vs. current characteristics
of output at MOSFET portion
Measured portion : across terminals
5,7 and 6,8 pin
Ambient temperature : 25°C

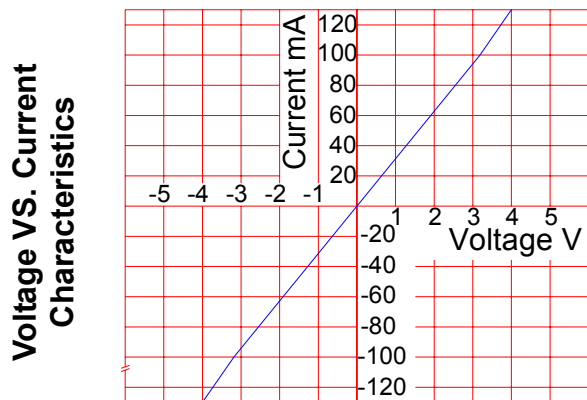

Ambient temperature : 25°C

PRODUCT SPECIFICATION

DATE : 03/01/2005

cosmo
ELECTRONICS CORPORATION

SOLID STATE RELAY - MOSFET OUTPUT
KAQW216H

Preliminary
SHEET 5 OF 7

REV.
0

LED forward current vs. Turn On Time

Across terminals 5,7 and 6,8 pin

Load voltage : 600V (DC)

Continuous load current : 120mA (DC)

Ambient temperature : 25°C

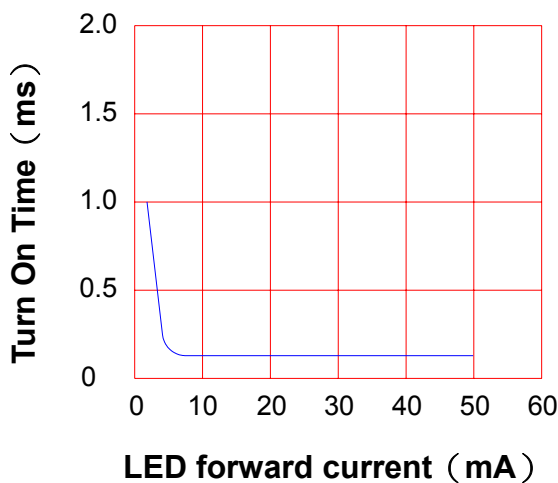

Off state leakage current

Across terminals 5,7 and 6,8 pin

Ambient temperature : 25°C

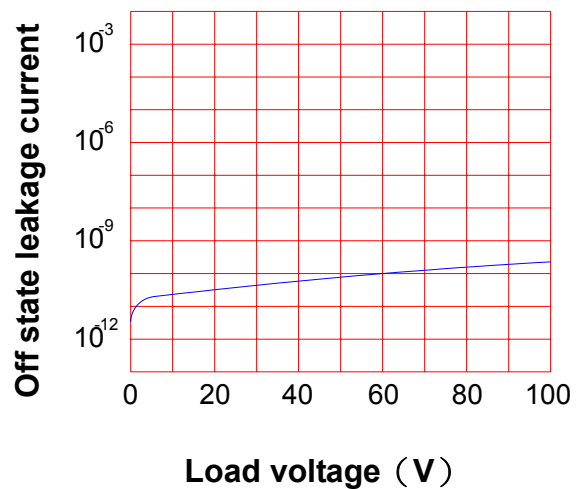

LED forward current vs. reverse(ON) time

Across terminals 5,7 and 6,8 pin

Load voltage : 600V (DC)

Continuous load current : 120mA (DC)

Ambient temperature : 25°C

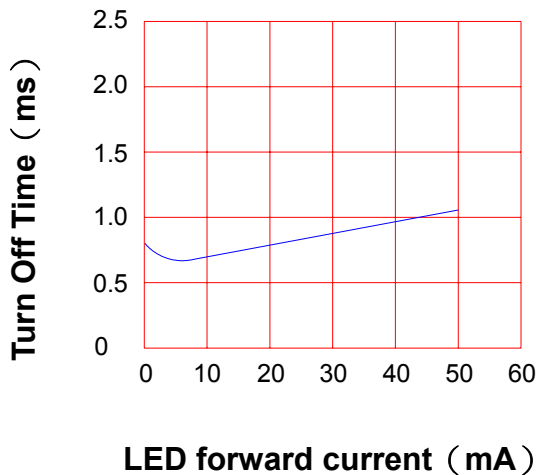

Applied voltage vs. output capacitance

Across terminals 5,7 and 6,8 pin

Frequency : 1MHz

Ambient temperature : 25°C

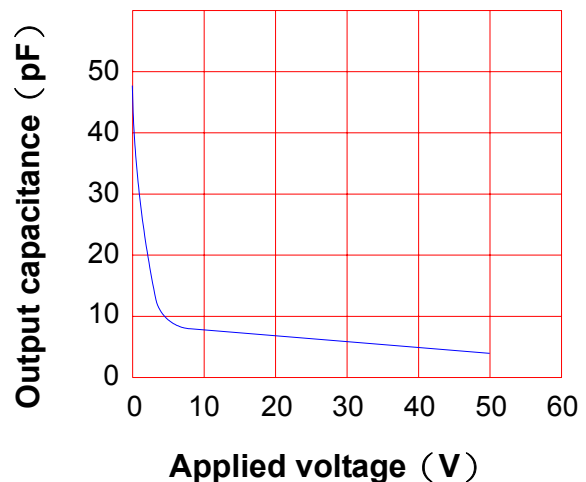

PRODUCT SPECIFICATION

DATE : 03/01/2005

cosmo
ELECTRONICS CORPORATION

SOLID STATE RELAY - MOSFET OUTPUT
KAQW216H

Preliminary
SHEET 6 OF 7

REV.
0

● USING METHODS

Examples of resistance value to control LED forward current (I_F)

SSR-MOSFET OUTPUT

($I_F=5\text{mA}$)

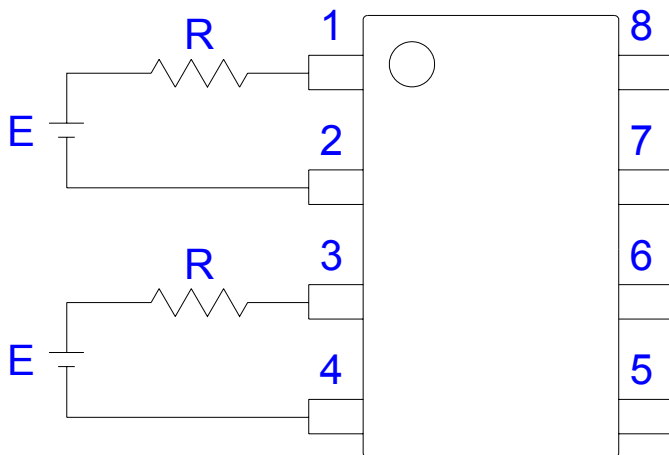

E	R
3.3V	Approx. 330 Ω
5V	Approx. 640 Ω
12V	Approx. 1.9K Ω
15V	Approx. 2.5K Ω
24V	Approx. 4.1K Ω

- (1) LED forward current must be more than 5mA , at E min.
- (2) LED forward current must be less than 50mA , at E max.

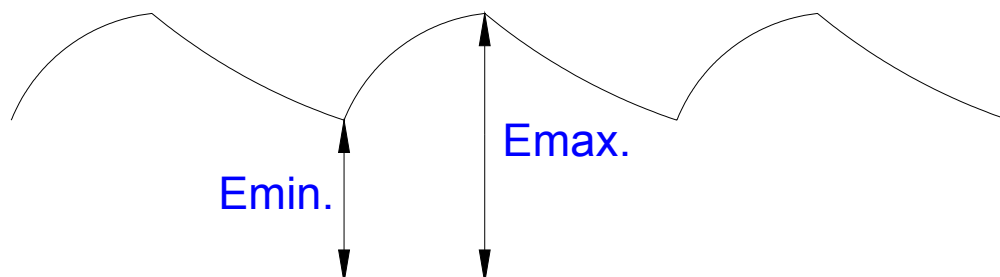

PRODUCT SPECIFICATION

DATE : 03/01/2005

cosmo
ELECTRONICS CORPORATION

SOLID STATE RELAY - MOSFET OUTPUT
KAQW216H

Preliminary
SHEET 7 OF 7

REV.
0

● USING METHODS

Regulate the spike voltage generated on the inductive load as follows :

