

# PRODUCT SPECIFICATION

DATE : 02/22/2011

<b>cosmo</b> ELECTRONICS CORPORATION	SOLID STATE RELAY - MOSFET OUTPUT <b>KAQW614H</b>	NO.60M22005	REV. 2
		SHEET 1 OF 10	

## ● OUTSIDE DIMENSION :

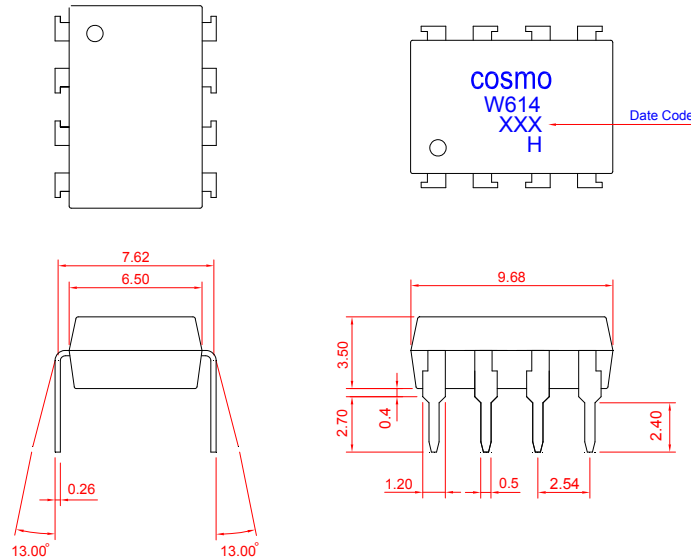

Unit : mm

Tolerance :  $\pm 0.2$ mm

## ● Operate / Reverse time ( N.C )

## ● Turn on / Turn off time ( N.O )

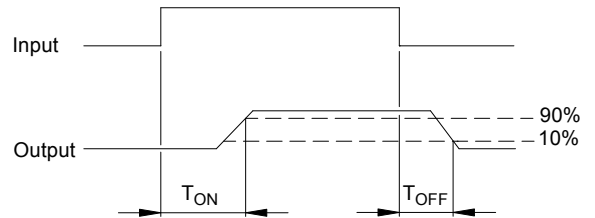
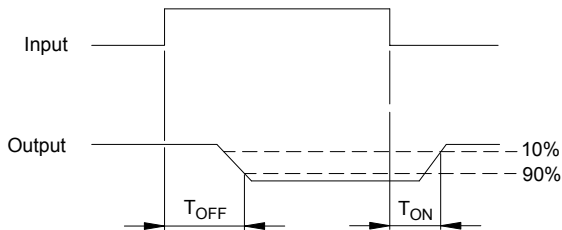

## ● Schematic and Wiring Diagrams

Schematic	Output Configuration	Load	Connection	Wiring Diagrams
	<p>1a1b</p> <p>1 FORM A/B 1 FORM C</p>	AC/DC	-	<p>(1) Two independent 1 Form A &amp; 1 Form B use</p> <p>(2) 1 Form A 1 Form B use</p>

# PRODUCT SPECIFICATION

DATE : 02/22/2011

<b>cosmo</b> ELECTRONICS CORPORATION	SOLID STATE RELAY - MOSFET OUTPUT <b>KAQW614H</b>	NO.60M22005	REV.
		SHEET 2 OF 10	2

## ● Absolute Maximum Ratings

(Ta=25°C)

Emitter ( Input )		Detector ( Output )	
Reverse Voltage .....	5.0V	Output Breakdown Voltage .....	± 400V
Continuous Forward Current .....	50mA	Continuous Load Current .....	± 130mA
Peak Forward Current .....	1A	Power Dissipation .....	500mW
Power Dissipation .....	100mW		
Derate Linearly from 25°C .....	1.3mW/°C		

## General Characteristics

Isolation Test Voltage .....	5000VACrms	Storage Temperature Range .....	-40°C to +125°C
Isolation Resistance		Operating Temperature Range ...	-40°C to +85°C
Viso=500V, Ta=25°C .....	≥ 10 <sup>10</sup> Ω	Junction Temperature .....	100°C
Total Power Dissipation .....	550mW	Soldering Temperature ,	
Derate Linearly from 25°C .....	2.5mW/°C	2mm from case , 10 sec .....	260°C

## ● Electro-optical Characteristics

(Ta=25°C)

Parameter	Symbol	Conditions	Min.	Typ.	Max.	Unit
<b>Emitter ( Input )</b>						
Forward Voltage	V <sub>F</sub>	I <sub>F</sub> =10mA		1.2	1.5	V
Operation Input Current	I <sub>FON</sub> ( N.O ) I <sub>FOFF</sub> ( N.C )	V <sub>L</sub> =±20V, I <sub>L</sub> =100mA ( N.O ) V <sub>L</sub> =±20V, I <sub>L</sub> ≤5μA ( N.C ) t=10ms			5	mA
Recovery Input Current	I <sub>FOFF</sub> ( N.O ) I <sub>FON</sub> ( N.C )	V <sub>L</sub> =±20V, I <sub>L</sub> ≤5μA ( N.O ) V <sub>L</sub> =±20V, I <sub>L</sub> =100mA ( N.C ) t=10ms	0.2			mA

### Detector ( Output ) normally open

Output Breakdown Voltage	V <sub>B</sub>	I <sub>B</sub> =50μA	400			V
Output Off-State Leakage	I <sub>TOFF</sub>	V <sub>T</sub> =100V, I <sub>F</sub> =0mA		0.2	1	μA
I/O Capacitance	C <sub>ISO</sub>	I <sub>F</sub> =0, f=1MHz		6		pF
ON Resistance	R <sub>ON</sub>	I <sub>L</sub> =100mA, I <sub>F</sub> =10mA		20	30	Ω
Turn-On Time	T <sub>ON</sub>	I <sub>F</sub> =10mA, V <sub>L</sub> =±20V		0.3	1.0	ms
Turn-Off Time	T <sub>OFF</sub>	t=10mS, I <sub>L</sub> =±100mA		0.7	1.5	ms

### Detector ( Output ) normally close

Output Breakdown Voltage	V <sub>B</sub>	I <sub>B</sub> =50μA, I <sub>F</sub> =10mA	400			V
Output Off-State Leakage	I <sub>TOFF</sub>	V <sub>T</sub> =100V, I <sub>F</sub> =10mA		0.2	2	μA
I/O Capacitance	C <sub>ISO</sub>	I <sub>F</sub> =0, f=1MHz		6		pF
ON Resistance	R <sub>ON</sub>	I <sub>L</sub> =100mA, I <sub>F</sub> =0mA		25	50	Ω
Operate ( OFF ) Time	T <sub>OFF</sub>	I <sub>F</sub> =10mA, V <sub>L</sub> =±20V		0.6	1.5	ms
Reverse ( ON ) Time	T <sub>ON</sub>	t=10ms, I <sub>L</sub> =±100mA		0.3	1.0	ms

# PRODUCT SPECIFICATION

DATE : 02/22/2011

<b>cosmo</b> ELECTRONICS CORPORATION	SOLID STATE RELAY - MOSFET OUTPUT <b>KAQW614H</b>	NO.60M22005	REV. 2
		SHEET 3 OF 10	

## ● Data Curve ( Normally Open Characteristics )

Load current vs. ambient temperature  
 Allowable ambient Temperature :  
 -40°C to +85°C

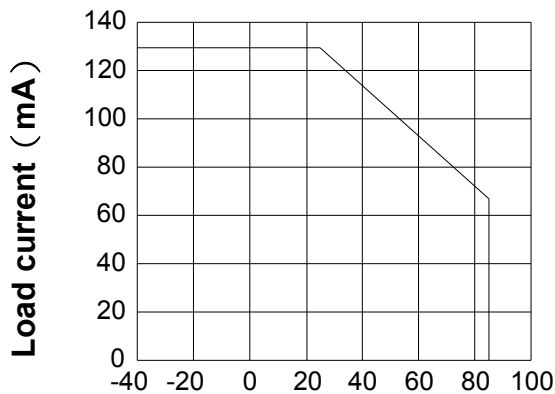

Ambient temperature Ta (°C)

On resistance vs. ambient temperature  
 across terminals 5 and 6 pin  
 LED current : 5mA  
 Continuous load current : 130mA (DC)

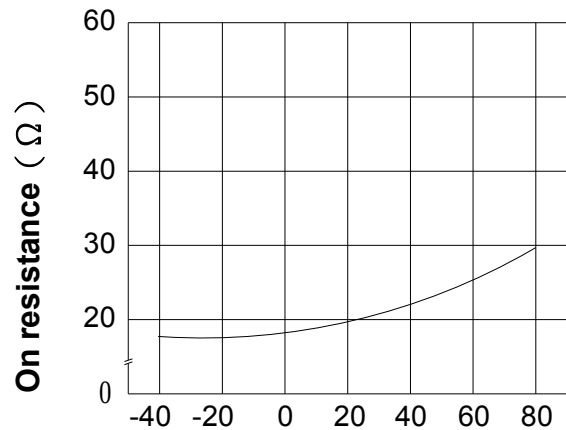

Ambient temperature Ta (°C)

Turn on time vs. ambient temperature  
 Load voltage 400V (DC)  
 LED current : 5mA  
 Continuous load current : 130mA (DC)

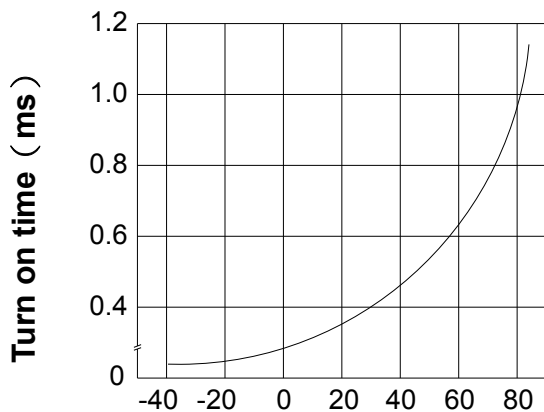

Ambient temperature Ta (°C)

Turn off time vs. ambient temperature  
 Load voltage 400V (DC)  
 LED current : 5mA  
 Continuous load current : 130mA (DC)

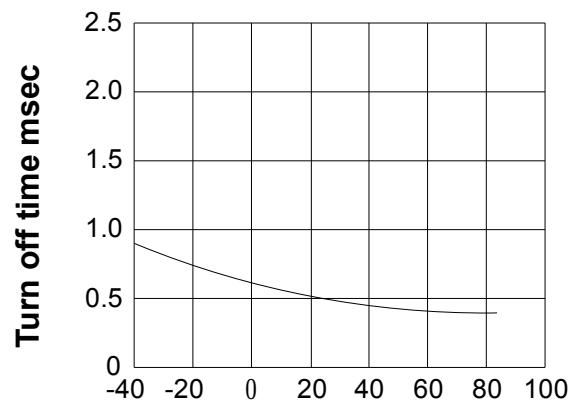

Ambient temperature Ta (°C)

# PRODUCT SPECIFICATION

DATE : 02/22/2011

**cosmo**  
ELECTRONICS CORPORATION

SOLID STATE RELAY - MOSFET OUTPUT  
**KAQW614H**

NO.60M22005  
SHEET 4 OF 10

REV.  
2

LED operate current vs.  
ambient temperature

Load Voltage : 400V (DC)

Continuous load current : 130mA (DC)

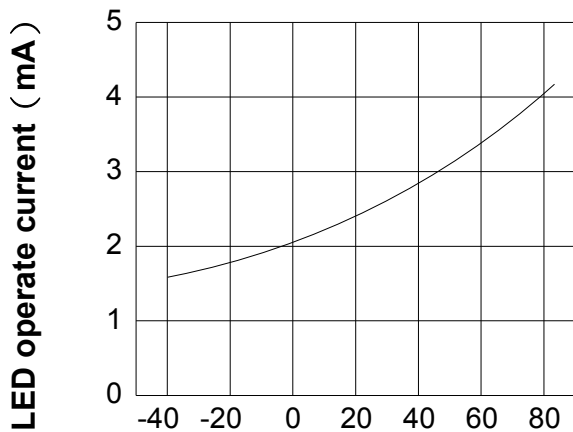

Ambient temperature Ta (°C)

LED Turn Off current vs.  
ambient temperature

Load Voltage : 400V (DC)

Continuous load current : 130mA (DC)

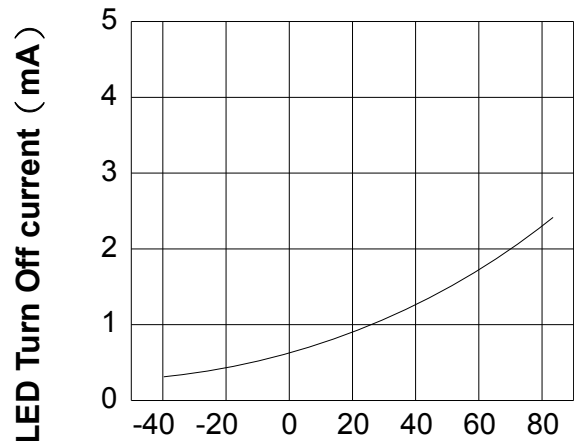

Ambient temperature Ta (°C)

LED dropout voltage vs.  
ambient temperature

LED current : 5 to 50mA

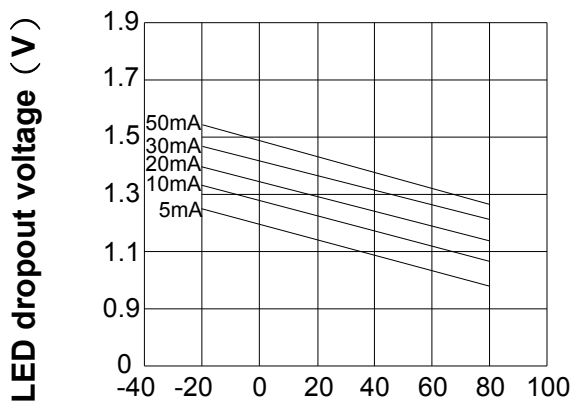

Ambient temperature Ta (°C)

Voltage vs. current characteristics  
of output at MOSFET portion

Measured portion : across terminals  
5 and 6 pin

Ambient temperature : 25°C

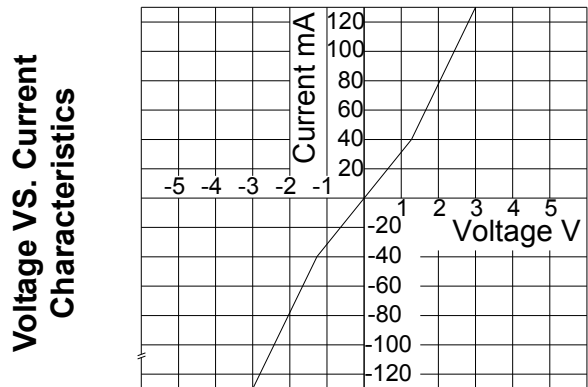

Ambient temperature : 25°C

# PRODUCT SPECIFICATION

DATE : 02/22/2011

**cosmo**  
ELECTRONICS CORPORATION

SOLID STATE RELAY - MOSFET OUTPUT  
**KAQW614H**

NO.60M22005  
SHEET 5 OF 10

REV.  
2

## LED forward current vs. turn on time

Across terminals 5 and 6 pin

Load voltage : 400V (DC)

Continuous load current : 130mA (DC)

Ambient temperature : 25°C

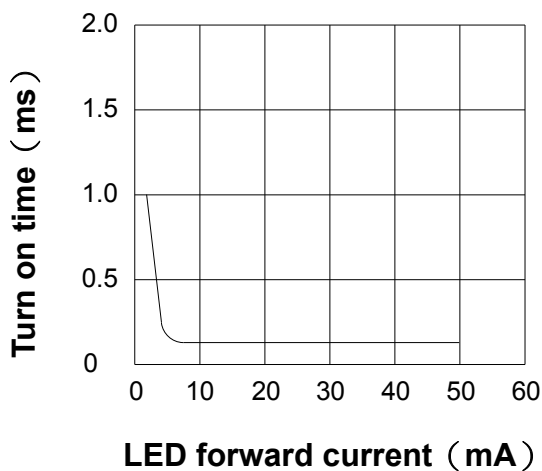

## Off state leakage current

Across terminals 5 and 6 pin

Ambient temperature : 25°C

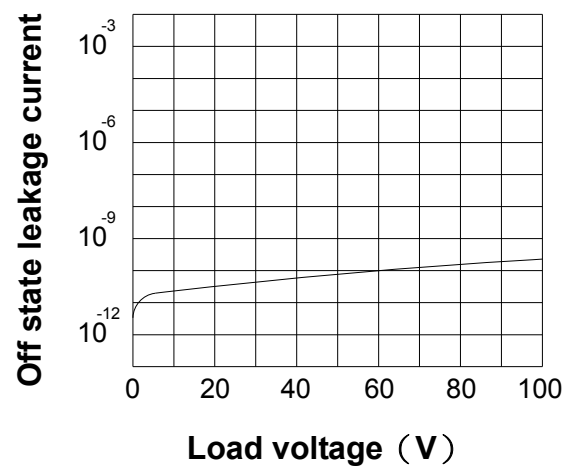

## LED forward current vs. turn off time

Across terminals 5 and 6 pin

Load voltage : 400V (DC)

Continuous load current : 130mA (DC)

Ambient temperature : 25°C

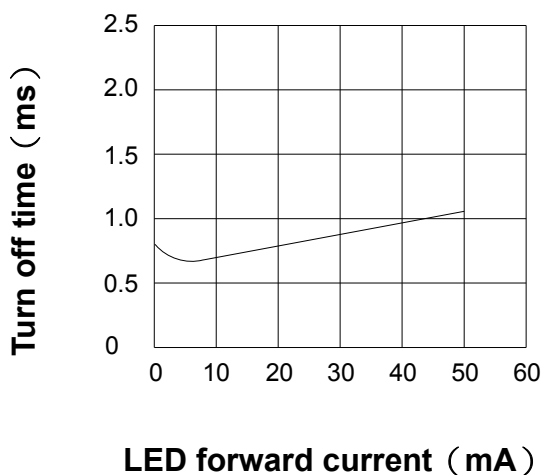

## Applied voltage vs. output capacitance

Across terminals 5 and 6 pin

Frequency : 1MHz

Ambient temperature : 25°C

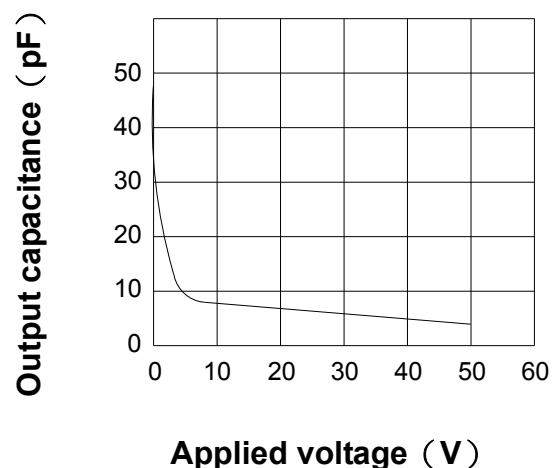

# PRODUCT SPECIFICATION

DATE : 02/22/2011

**cosmo**  
ELECTRONICS CORPORATION

SOLID STATE RELAY - MOSFET OUTPUT  
**KAQW614H**

NO.60M22005  
SHEET 6 OF 10

REV.  
2

## ● Data Curve ( Normally Close Characteristics )

Load current vs. ambient temperature  
Allowable ambient Temperature :  
-40°C to +85°C

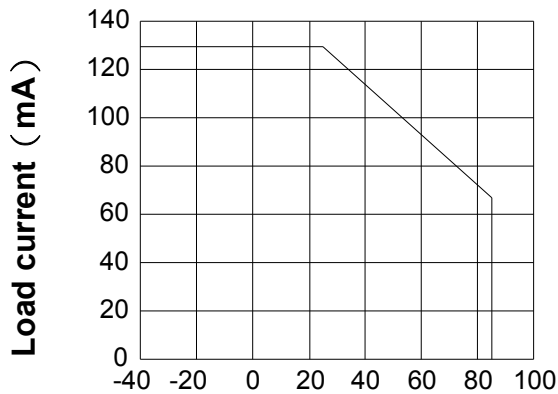

Ambient temperature Ta (°C)

On resistance vs. ambient temperature  
across terminals 7 and 8 pin  
LED current : 0mA  
Continuous load current : 130mA (DC)

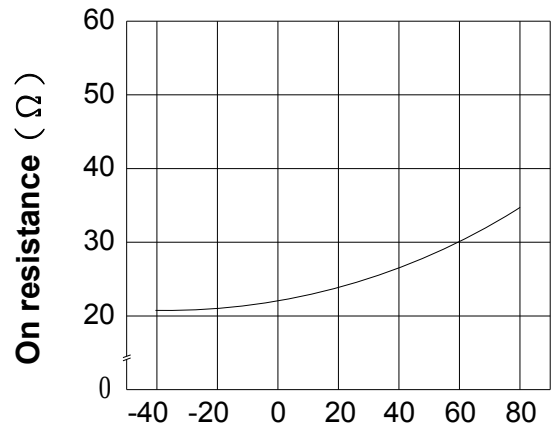

Ambient temperature Ta (°C)

Operate (OFF) time vs.  
ambient temperature  
Load voltage 400V (DC)  
LED current : 5mA  
Continuous load current : 130mA (DC)

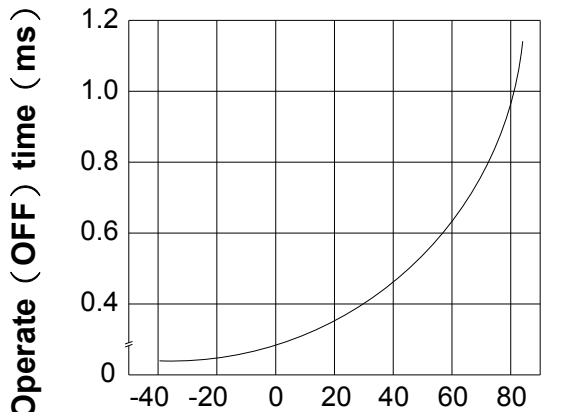

Ambient temperature Ta (°C)

Reverse (ON) time vs.  
ambient temperature  
Load voltage 400V (DC)  
LED current : 5mA  
Continuous load current : 130mA (DC)

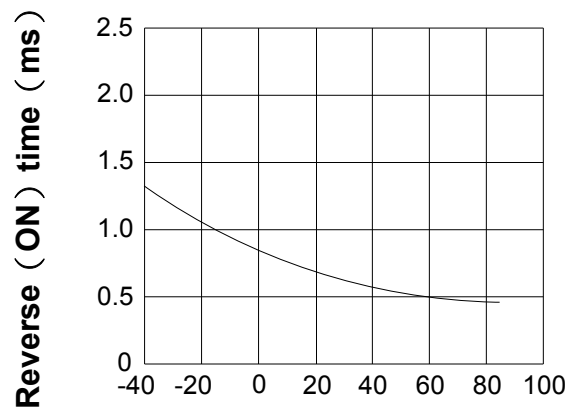

Ambient temperature Ta (°C)

# PRODUCT SPECIFICATION

DATE : 02/22/2011

**cosmo**  
ELECTRONICS CORPORATION

SOLID STATE RELAY - MOSFET OUTPUT  
**KAQW614H**

NO.60M22005  
SHEET 7 OF 10

REV.  
2

**LED Operate ( OFF ) current vs.  
ambient temperature**  
Load Voltage : 400V ( DC )  
Continuous load current : 130mA ( DC )

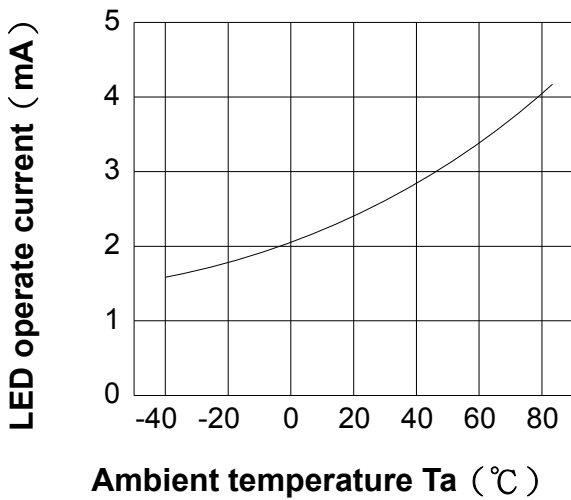

**LED Reverse ( ON ) current vs.  
ambient temperature**  
Load Voltage : 400V ( DC )  
Continuous load current : 130mA ( DC )

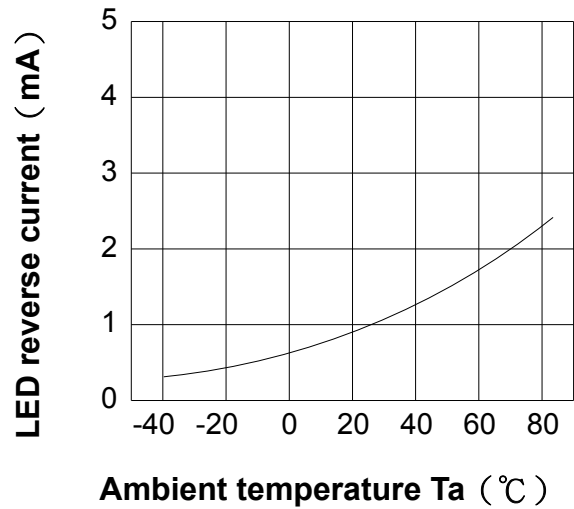

**LED dropout voltage vs.  
ambient temperature**  
LED current : 5 to 50mA

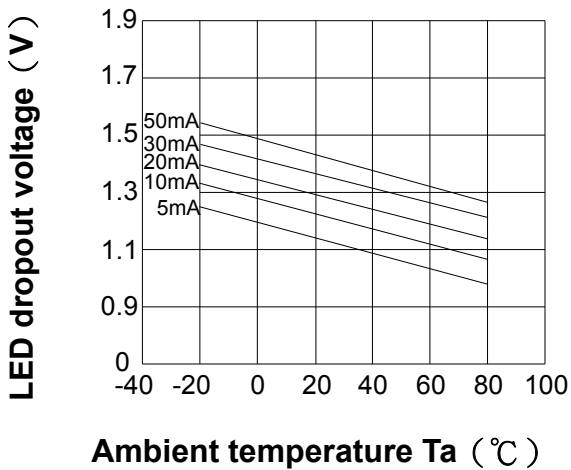

**Voltage vs. current characteristics  
of output at MOSFET portion**  
Measured portion : across terminals  
7 and 8 pin  
Ambient temperature : 25°C

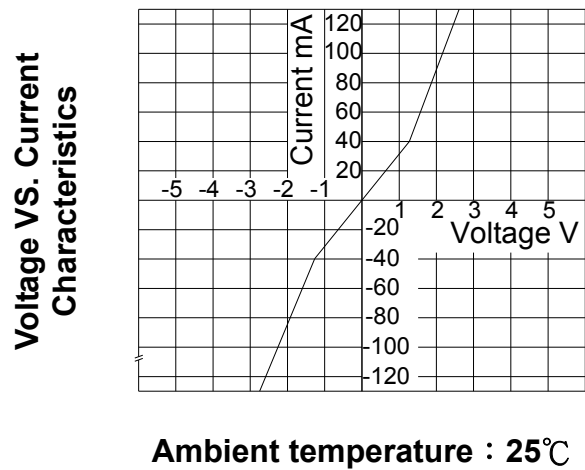

# PRODUCT SPECIFICATION

DATE : 02/22/2011

<b>cosmo</b> ELECTRONICS CORPORATION	SOLID STATE RELAY - MOSFET OUTPUT <b>KAQW614H</b>	NO.60M22005	REV. 2
		SHEET 8 OF 10	

## LED forward current vs. operate ( OFF ) time

Across terminals 7 and 8 pin

Load voltage : 400V ( DC )

Continuous load current : 130mA ( DC )

Ambient temperature : 25°C

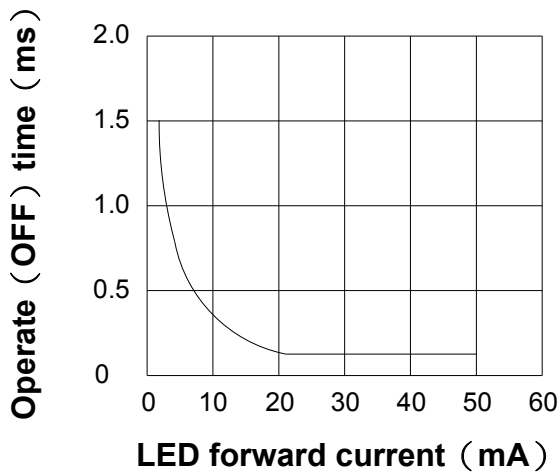

## Off state leakage current

Across terminals 7 and 8 pin

Ambient temperature : 25°C

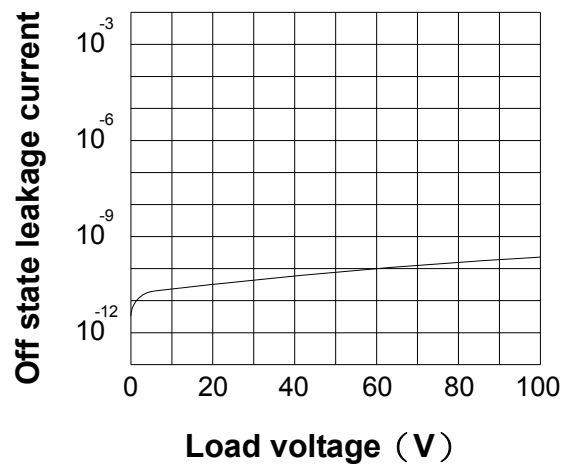

## LED forward current vs. reverse ( ON ) time

Across terminals 7 and 8 pin

Load voltage : 400V ( DC )

Continuous load current : 130mA ( DC )

Ambient temperature : 25°C

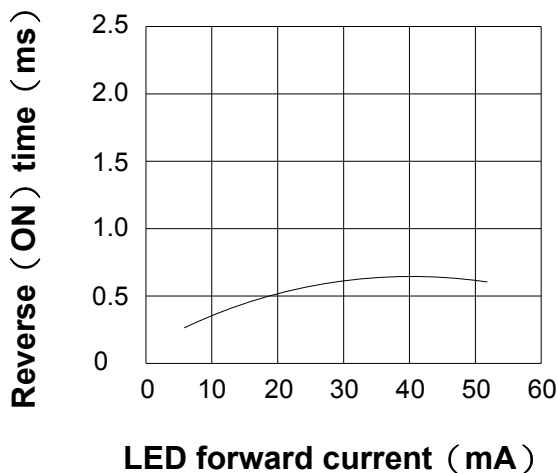

## Applied voltage vs. output capacitance

Across terminals 7 and 8 pin

Frequency : 1MHz

Ambient temperature : 25°C

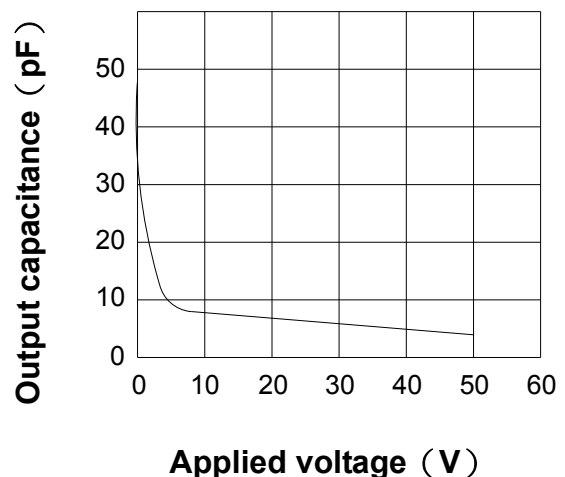



# PRODUCT SPECIFICATION

DATE : 02/22/2011

<b>cosmo</b> ELECTRONICS CORPORATION	SOLID STATE RELAY - MOSFET OUTPUT <b>KAQW614H</b>	NO.60M22005	REV. 2
		SHEET 9 OF 10	

## ● USING METHODS

Examples of resistance value to control LED forward current (IF)

SSR-MOSFET OUTPUT

(IF=5mA)

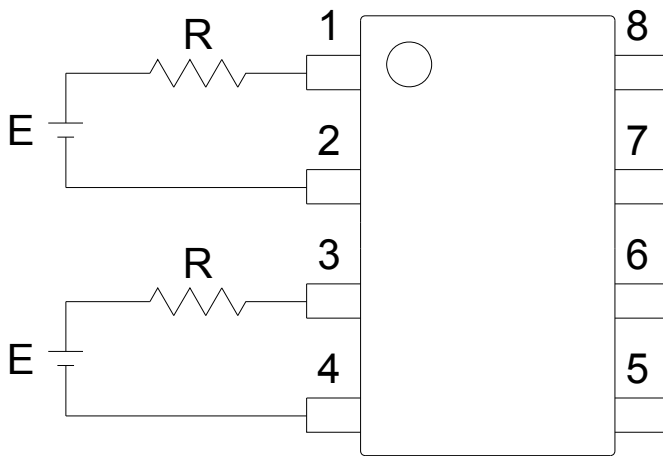

E	R
3.3V	Approx. 330 Ω
5V	Approx. 640 Ω
12V	Approx. 1.9K Ω
15V	Approx. 2.5K Ω
24V	Approx. 4.1K Ω

- (1) LED forward current must be more than 5mA , at E min.
- (2) LED forward current must be less than 50mA , at E max.

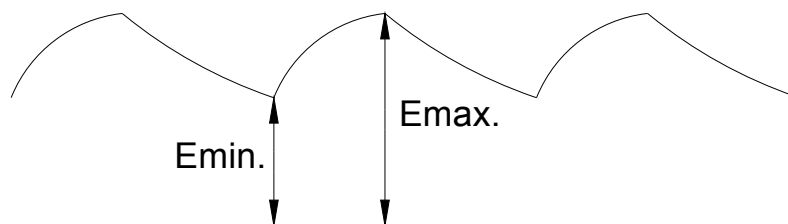

# PRODUCT SPECIFICATION

DATE : 02/22/2011

**cosmo**  
ELECTRONICS CORPORATION

SOLID STATE RELAY - MOSFET OUTPUT  
**KAQW614H**

NO.60M22005  
SHEET 10 OF 10

REV.  
2

## ● USING METHODS

Regulate the spike voltage generated on the inductive load as follows :

