

### Features

- Diffused Junction
- Low Forward Voltage Drop
- High Current Capability
- High Reliability
- High Surge Current Capability
- Ideal for Printed Circuit Boards
-  Recognized File # E157705

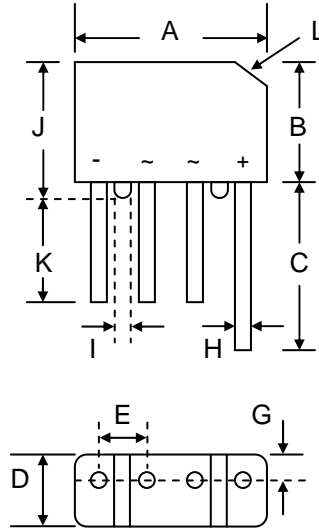

KBP		
Dim	Min	Max
A	14.22	15.24
B	10.67	11.68
C	15.20	—
D	4.57	5.08
E	3.60	4.10
G	1.00	1.40
H	0.76	0.86
I	1.52	—
J	11.68	12.70
K	12.7	—
L	3.2 x 45° Typical	
All Dimensions in mm		

### Mechanical Data

- Case: KBP, Molded Plastic
- Terminals: Plated Leads Solderable per MIL-STD-202, Method 208
- Polarity: As Marked on Body
- Weight: 1.7 grams (approx.)
- Mounting Position: Any
- Marking: Type Number
- **Lead Free: For RoHS / Lead Free Version, Add “-LF” Suffix to Part Number, See Page 4**

### Maximum Ratings and Electrical Characteristics @T<sub>A</sub>=25°C unless otherwise specified

Single Phase, half wave, 60Hz, resistive or inductive load. For capacitive load, derate current by 20%.

Characteristic	Symbol	KBP 200	KBP 201	KBP 202	KBP 204	KBP 206	KBP 208	KBP 2010	Unit
Peak Repetitive Reverse Voltage	V <sub>RRM</sub>								V
Working Peak Reverse Voltage	V <sub>RWM</sub>	50	100	200	400	600	800	1000	
DC Blocking Voltage	V <sub>R</sub>								
RMS Reverse Voltage	V <sub>R(RMS)</sub>	35	70	140	280	420	560	700	V
Average Rectified Output Current @T <sub>A</sub> = 50°C	I <sub>O</sub>	2.0							A
Non-Repetitive Peak Forward Surge Current 8.3ms Single Half Sine-Wave Superimposed on Rated Load (JEDEC Method)	I <sub>FSM</sub>	60							A
Forward Voltage per leg @I <sub>F</sub> = 2.0A	V <sub>FM</sub>	1.1							V
Peak Reverse Current @T <sub>A</sub> = 25°C At Rated DC Blocking Voltage @T <sub>A</sub> = 125°C	I <sub>RM</sub>	5.0 500							μA
I <sup>2</sup> t Rating for Fusing (t < 8.3ms)	I <sup>2</sup> t	15							A <sup>2</sup> s
Typical Junction Capacitance (Note 1)	C <sub>J</sub>	25							pF
Thermal Resistance Junction to Ambient (Note 2)	R <sub>JA</sub>	30							°C/W
Thermal Resistance Junction to Lead (Note 2)	R <sub>JL</sub>	11							
Operating and Storage Temperature Range	T <sub>J</sub> , T <sub>STG</sub>	-55 to +150							°C

Note: 1. Measured at 1.0 MHz and applied reverse voltage of 4.0V D.C.

2. Mounted on PCB with 12 x 12mm copper pads and measured at lead length 9.5mm from case.

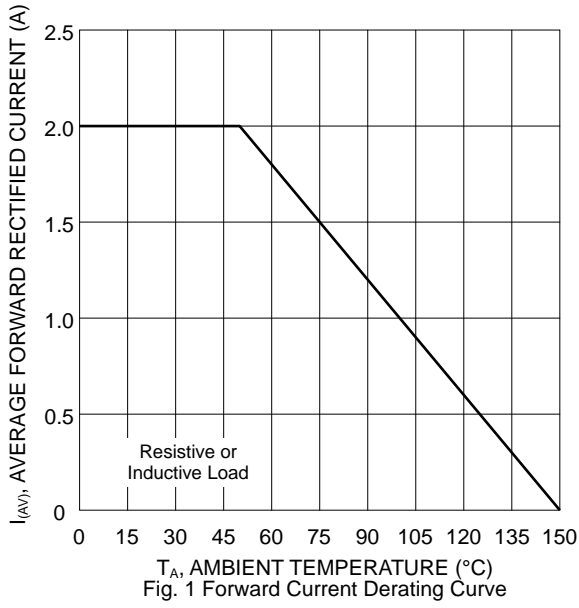

Fig. 1 Forward Current Derating Curve

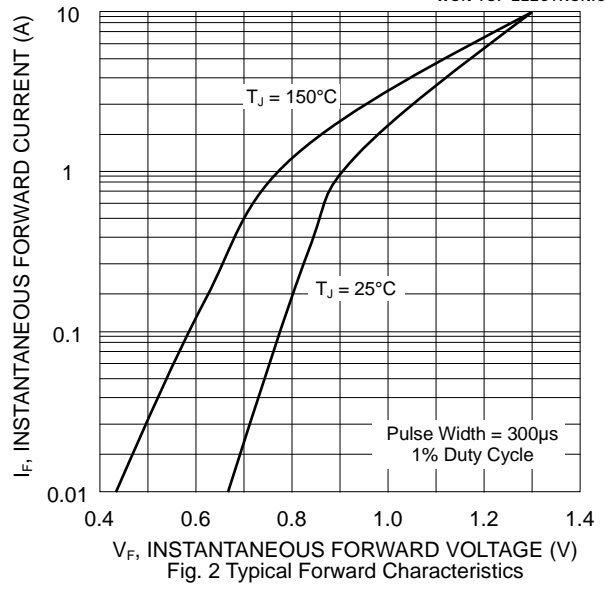

Fig. 2 Typical Forward Characteristics

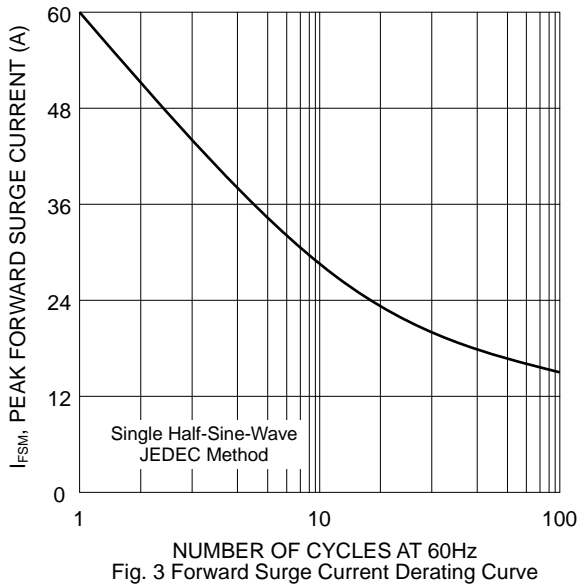

Fig. 3 Forward Surge Current Derating Curve

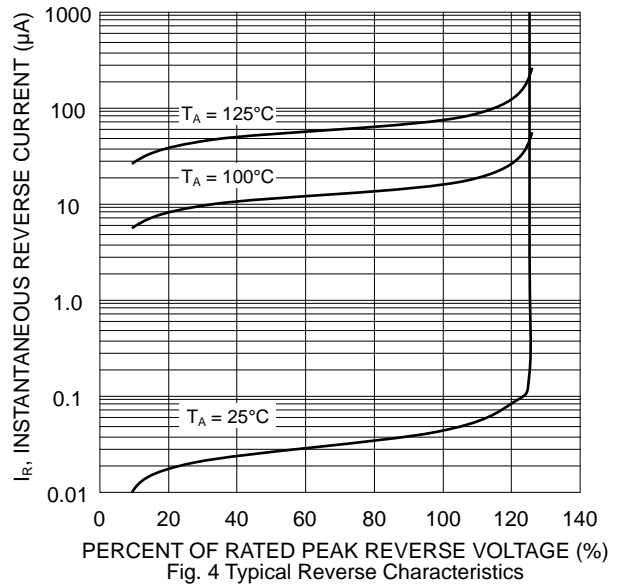

Fig. 4 Typical Reverse Characteristics

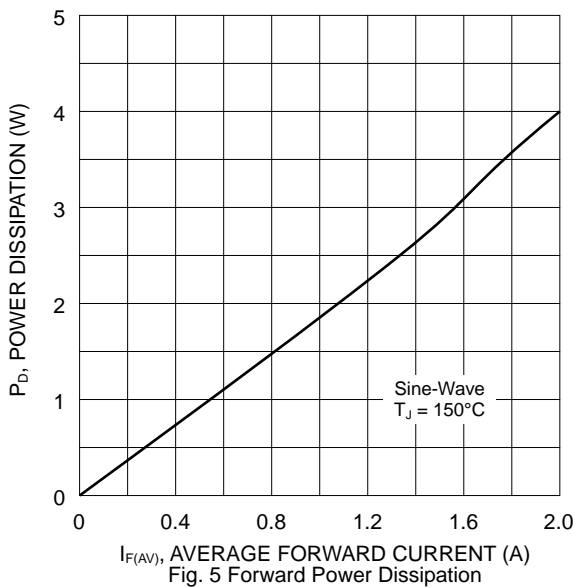

Fig. 5 Forward Power Dissipation

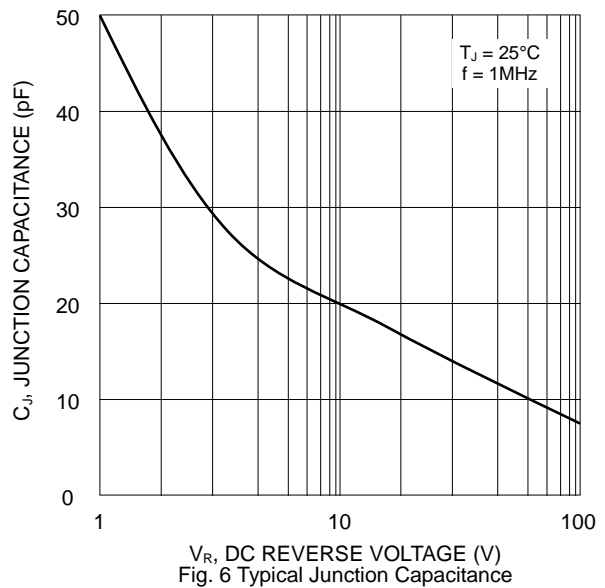
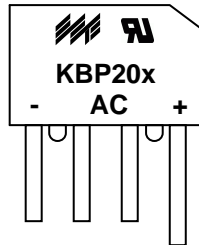

Fig. 6 Typical Junction Capacitance

## MARKING INFORMATION



KBP20x = Device Number  
 x = 0, 1, 2, 4, 6, 8 or 10  
 Polarity = As Marked on Body

## PACKAGING INFORMATION

### BULK

Inner Box Size L x W x H (mm)	Quantity (PCS)	Carton Size L x W x H (mm)	Quantity (PCS)	Approx. Gross Weight (KG)
200 x 160 x 42	600	425 x 215 x 280	7,200	17.0

**Note:** 1. Paper box, white or brown color.

## ORDERING INFORMATION

Product No.	Package Type	Shipping Quantity
KBP200	SIL Bridge	600 Units/Box
KBP201	SIL Bridge	600 Units/Box
KBP202	SIL Bridge	600 Units/Box
KBP204	SIL Bridge	600 Units/Box
KBP206	SIL Bridge	600 Units/Box
KBP208	SIL Bridge	600 Units/Box
KBP2010	SIL Bridge	600 Units/Box

1. Shipping quantity given is for minimum packing quantity only. For minimum order quantity, please consult the Sales Department.
2. **To order RoHS / Lead Free version (with Lead Free finish), add "-LF" suffix to part number above. For example, KBP200-LF.**

WON-TOP ELECTRONICS and  are registered trademarks of Won-Top Electronics Co., Ltd (WTE). WTE has checked all information carefully and believes it to be correct and accurate. However, WTE cannot assume any responsibility for inaccuracies. Furthermore, this information does not give the purchaser of semiconductor devices any license under patent rights to manufacturer. WTE reserves the right to change any or all information herein without further notice.

**WARNING:** DO NOT USE IN LIFE SUPPORT EQUIPMENT. WTE power semiconductor products are not authorized for use as critical components in life support devices or systems without the express written approval.

**Won-Top Electronics Co., Ltd.**  
No. 44 Yu Kang North 3rd Road,  
Chine Chen Dist., Kaohsiung 806, Taiwan  
**Phone:** 886-7-822-5408 or 886-7-822-5410  
**Fax:** 886-7-822-5417  
**Email:** sales@wontop.com  
**Internet:** <http://www.wontop.com>

*We power your everyday.*