

Features

- Glass Passivated Die Construction
- Low Forward Voltage Drop
- High Current Capability
- High Reliability
- High Surge Current Capability
- Ideal for Printed Circuit Boards
-  Recognized File # E157705

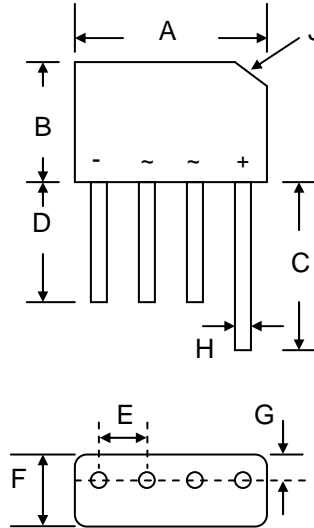

KBPM		
Dim	Min	Max
A	14.22	15.24
B	10.60	11.68
C	15.20	—
D	12.70	—
E	3.60	4.10
F	3.70	3.90
G	1.27 Typical	
H	0.70	0.90
J	3.2 x 45° Typical	
All Dimensions in mm		

Mechanical Data

- Case: KBPM, Molded Plastic
- Terminals: Plated Leads Solderable per MIL-STD-202, Method 208
- Polarity: As Marked on Body
- Weight: 1.7 grams (approx.)
- Mounting Position: Any
- Marking: Type Number
- **Lead Free: For RoHS / Lead Free Version, Add “-LF” Suffix to Part Number, See Page 4**

Maximum Ratings and Electrical Characteristics @T_A=25°C unless otherwise specified

Single Phase, half wave, 60Hz, resistive or inductive load. For capacitive load, derate current by 20%.

Characteristic	Symbol	KBP 200G	KBP 201G	KBP 202G	KBP 204G	KBP 206G	KBP 208G	KBP 2010G	Unit
Peak Repetitive Reverse Voltage	V _{RRM}								V
Working Peak Reverse Voltage	V _{RWM}	50	100	200	400	600	800	1000	
DC Blocking Voltage	V _R								
RMS Reverse Voltage	V _{R(RMS)}	35	70	140	280	420	560	700	V
Average Rectified Output Current @T _A = 55°C	I _O	2.0							A
Non-Repetitive Peak Forward Surge Current 8.3ms Single Half Sine-Wave Superimposed on Rated Load (JEDEC Method)	I _{FSM}	60							A
Forward Voltage per leg @I _F = 2.0A	V _{FM}	1.1							V
Peak Reverse Current @T _A = 25°C At Rated DC Blocking Voltage @T _A = 125°C	I _{RM}	5.0 500							μA
I ² t Rating for Fusing (t < 8.3ms)	I ² t	15							A ² s
Typical Junction Capacitance (Note 1)	C _J	25							pF
Thermal Resistance Junction to Ambient (Note 2)	R _{JA}	30							°C/W
Thermal Resistance Junction to Lead (Note 2)	R _{JL}	11							
Operating and Storage Temperature Range	T _J , T _{STG}	-55 to +165							°C

Note: 1. Measured at 1.0 MHz and applied reverse voltage of 4.0V D.C.
2. Mounted on PCB with 12 x 12mm copper pads and measured at lead length 9.5mm from case.

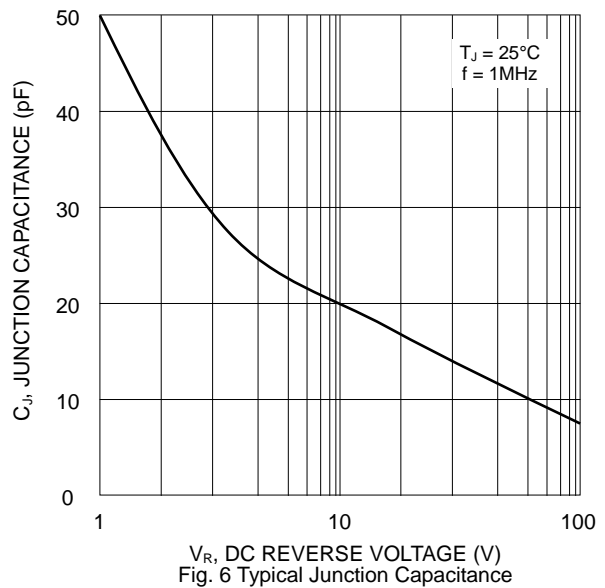
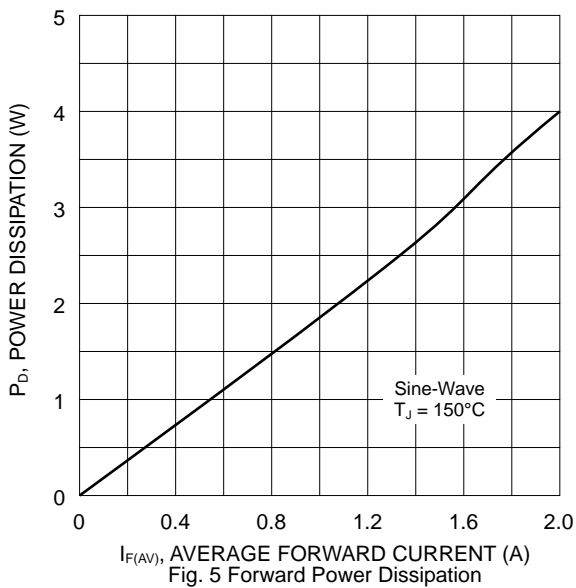
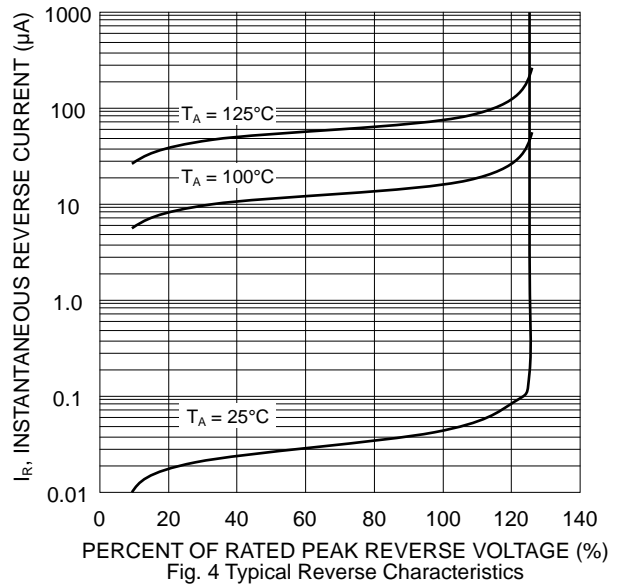
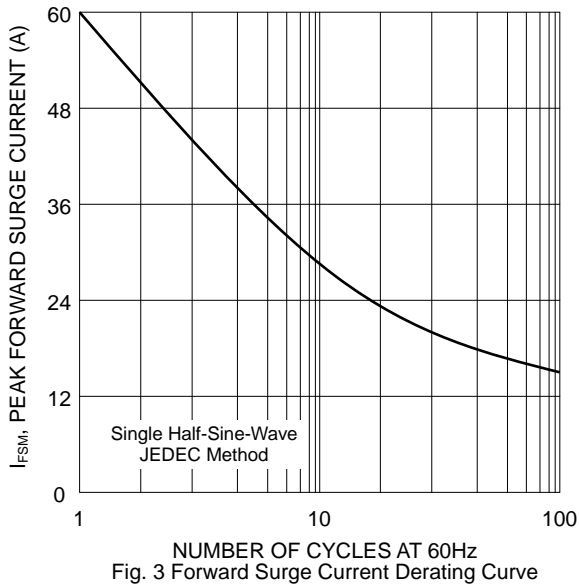
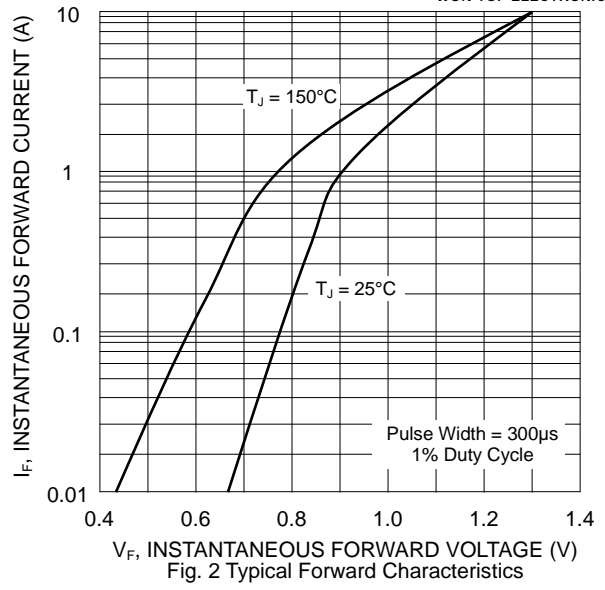
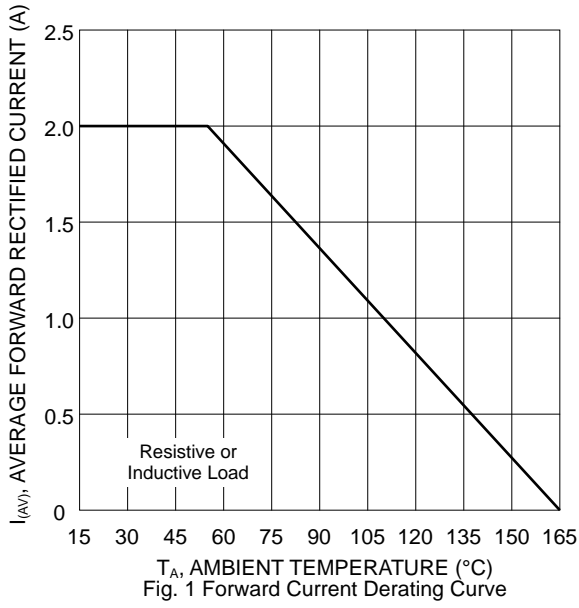

MARKING INFORMATION

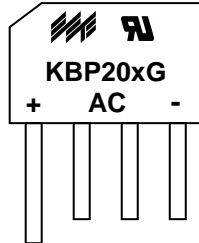

KBP20xG = Device Number
 x = 0, 1, 2, 4, 6, 8 or 10
 Polarity = As Marked on Body

PACKAGING INFORMATION

BULK

Tube Size L x W x H (mm)	Quantity (PCS)	Inner Box Size L x W x H (mm)	Quantity (PCS)	Carton Size L x W x H (mm)	Quantity (PCS)	Approx. Gross Weight (KG)
393 x 35 x 6	25	400 x 140 x 76	1,000	415 x 300 x 185	4,000	12.0

Note: 1. Anti-static tube, water clear color.

ORDERING INFORMATION

Product No.	Package Type	Shipping Quantity
KBP200G	SIL Bridge	25 Units/Tube
KBP201G	SIL Bridge	25 Units/Tube
KBP202G	SIL Bridge	25 Units/Tube
KBP204G	SIL Bridge	25 Units/Tube
KBP206G	SIL Bridge	25 Units/Tube
KBP208G	SIL Bridge	25 Units/Tube
KBP2010G	SIL Bridge	25 Units/Tube

1. Shipping quantity given is for minimum packing quantity only. For minimum order quantity, please consult the Sales Department.
2. **To order RoHS / Lead Free version (with Lead Free finish), add "-LF" suffix to part number above. For example, KBP200G-LF.**

WON-TOP ELECTRONICS and  are registered trademarks of Won-Top Electronics Co., Ltd (WTE). WTE has checked all information carefully and believes it to be correct and accurate. However, WTE cannot assume any responsibility for inaccuracies. Furthermore, this information does not give the purchaser of semiconductor devices any license under patent rights to manufacturer. WTE reserves the right to change any or all information herein without further notice.

WARNING: DO NOT USE IN LIFE SUPPORT EQUIPMENT. WTE power semiconductor products are not authorized for use as critical components in life support devices or systems without the express written approval.

Won-Top Electronics Co., Ltd.
No. 44 Yu Kang North 3rd Road,
Chine Chen Dist., Kaohsiung 806, Taiwan
Phone: 886-7-822-5408 or 886-7-822-5410
Fax: 886-7-822-5417
Email: sales@wontop.com
Internet: <http://www.wontop.com>

We power your everyday.