

KBPC10005 THRU KBPC5010

List

List..... 1

Package outline..... 2

Features..... 2

Mechanical data..... 3

Maximum ratings 3

Electrical characteristics..... 3

Rating and characteristic curves..... 4

Marking..... 5

Bulk & Tray packing.....5

Suggested thermal profiles for soldering processes..... 6

High reliability test capabilities.....7

KBPC10005 THRU KBPC5010

10.0A ~ 50.0A Single-Phase Bridge Rectifiers - 50V-1000V

Package outline

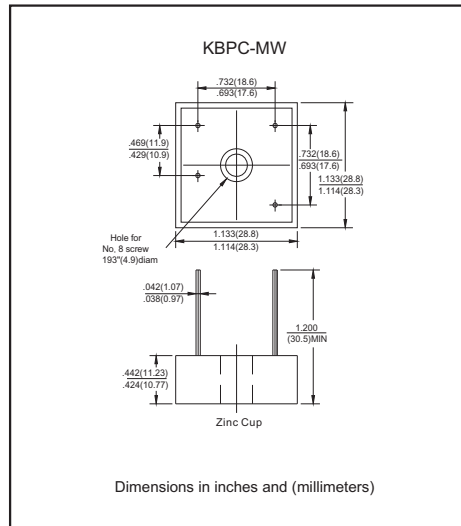
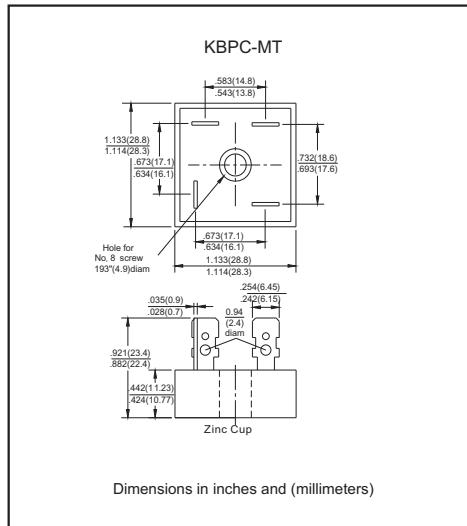

Features

- Surge overload 240 ~ 500 amperes peak
- Low forward drop voltage
- Integrally molded heatsink provides very low thermal Resistance for maximum heat dissipation
- Plastic passivated chip junctions.
- Lead-free parts meet RoHS requirements
- UL recognized file # E321971

Mechanical data

- Epoxy:UL94-V0 rated flame retardant
- Case : Metal Case KBPC-M
- Terminals : Solder plated, solderable per MIL-STD-750, Method 2026
- Polarity : marked on side body
- Mounting Torque: 20 in-lb (23cm-kg) max.
- Weight : KBPC-MT , 0.74 ounce, 21 grams
KBPC-MW, 0.63 ounce, 18 grams

Part Numbering

KBPCXX XX - X

Lead Types,
T : faston terminals
W : wire leads

Reverse Voltage,
005: 50V 01: 100V 02: 200V
04: 400V 06: 600V 08: 800V
10: 1000V

Forward Rectified Output Current,
10: 10.0A 15: 15.0A 25: 25.0A
35: 35.0A 50: 50.0A

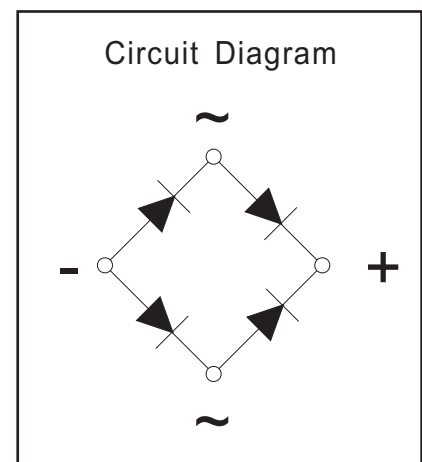

KBPC10005 THRU KBPC5010

Maximum ratings and electrical characteristics (AT $T_A=25^\circ\text{C}$ unless otherwise noted)

CHARACTERISTICS	SYMBOL	KBPC	KBPC	KBPC	KBPC	KBPC	KBPC	KBPC	UNIT			
		10005	1001	1002	1004	1006	1008	1010				
		15005	1501	1502	1504	1506	1508	1510				
		25005	2501	2502	2504	2506	2508	2510				
		35005	3501	3502	3504	3506	3508	3510				
		50005	5001	5002	5004	5006	5008	5010				
Maximum recurrent peak reverse voltage	V_{RRM}	50	100	200	400	600	800	1000	V			
Maximum RMS bridge input voltage	V_{RMS}	35	70	140	280	420	560	700	V			
Maximum average forward Rectified output current @ $T_C=55^\circ\text{C}$	$I_{F(AV)}$	KBPC 10	10 240	KBPC 15	15 300	KBPC 25	25 400	KBPC 35	35 400	KBPC 50	50 500	A
Peak forward surge current 8.3ms single half sine-wave	I_{FSM}	10	240	15	300	25	400	35	400	50	500	A
Maximum forward voltage drop per element KBPC10 at $I_F=5.0\text{A}$ KBPC15 at $I_F=7.5\text{A}$ KBPC25 at $I_F=12.5\text{A}$ KBPC35 at $I_F=17.5\text{A}$ KBPC50 at $I_F=25.0\text{A}$	V_F	1.1									V	
Maximum reverse current at rate $T_J=25^\circ\text{C}$ DC blocking voltage per element $T_J=100^\circ\text{C}$	I_R	10.0 500									μA	
Operating junction temperature range	T_J	-55 to +125									$^\circ\text{C}$	
Storage temperature range	T_{STG}	-55 to +150									$^\circ\text{C}$	

Rating and characteristic curves (KBPC10005 THRU KBPC5010)

FIG. 1 - DERATING CURVE OUTPUT RECTIFIED CURRENT

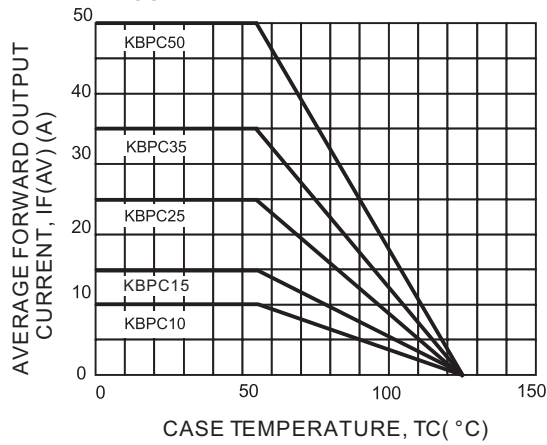

FIG. 2 - MAXIMUM NON-REPETITIVE PEAK FORWARD SURGE CURRENT

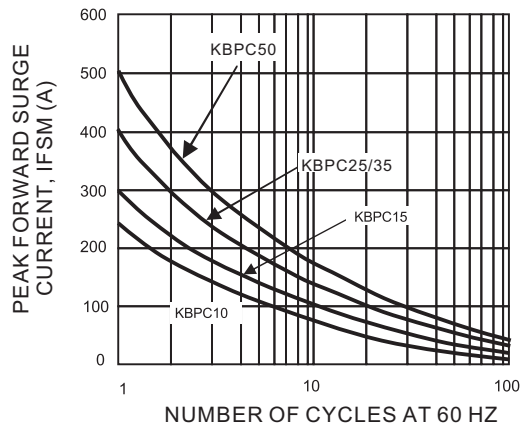

FIG. 3 - TYPICAL FORWARD CHARACTERISTICS

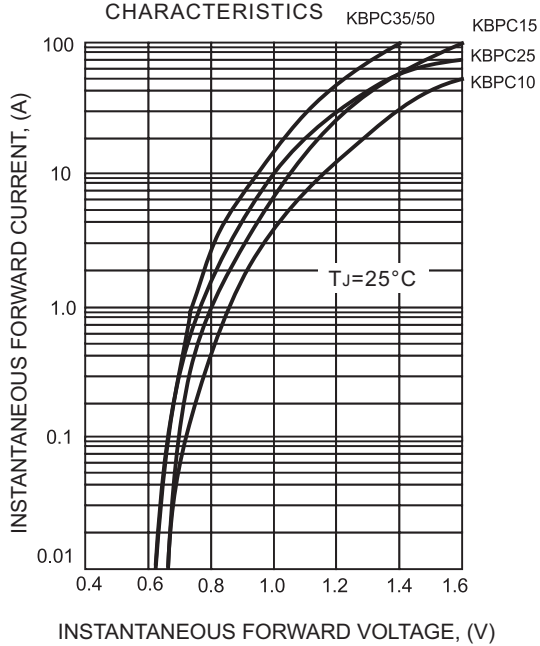
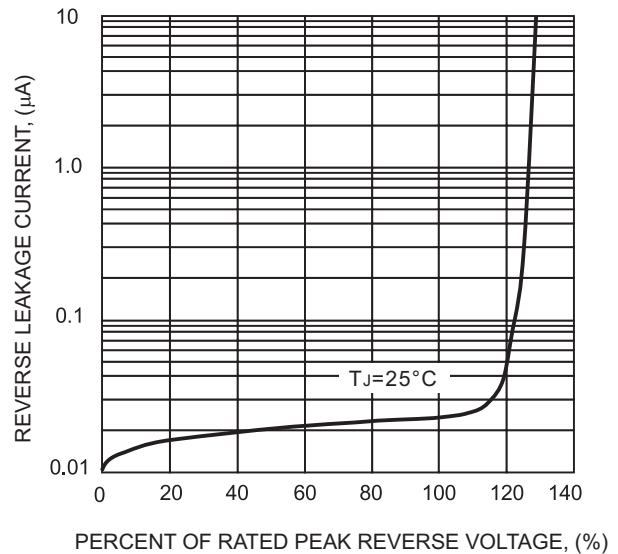

FIG.4-TYPICAL REVERSE CHARACTERISTICS



KBPC10005 THRU KBPC5010

Marking

Type number	Marking code
KBPCXX005	KBPCXX005
KBPCXX01	KBPCXX01
KBPCXX02	KBPCXX02
KBPCXX04	KBPCXX04
KBPCXX06	KBPCXX06
KBPCXX08	KBPCXX08
KBPCXX10	KBPCXX10

XX=10, 15, 25, 35, or 50

BULK PACKING

DEVICE CASE TYPE	Q'TY 1 (PCS / BOX)	INNER BOX SIZE (m/m)	CARTON SIZE (m/m)	Q'TY 2 (PCS / CARTON)	APPROX. CROSS WEIGHT(kg)
KBPC-MT	50	203 * 203 * 44	435 * 215 * 260	500	15.4

TRAY PACKING

DEVICE CASE TYPE	Q'TY 1 (PCS / TRAY)	TRAY SIZE (m/m)	CARTON SIZE (m/m)	Q'TY 2 (PCS / CARTON)	APPROX. CROSS WEIGHT(kg)
KBPC-MW	100	330 * 280 * 30	340 * 300 * 260	500	8.4

KBPC10005 THRU KBPC5010

Suggested thermal profiles for soldering processes

1. Lead free temperature profile wave-soldering

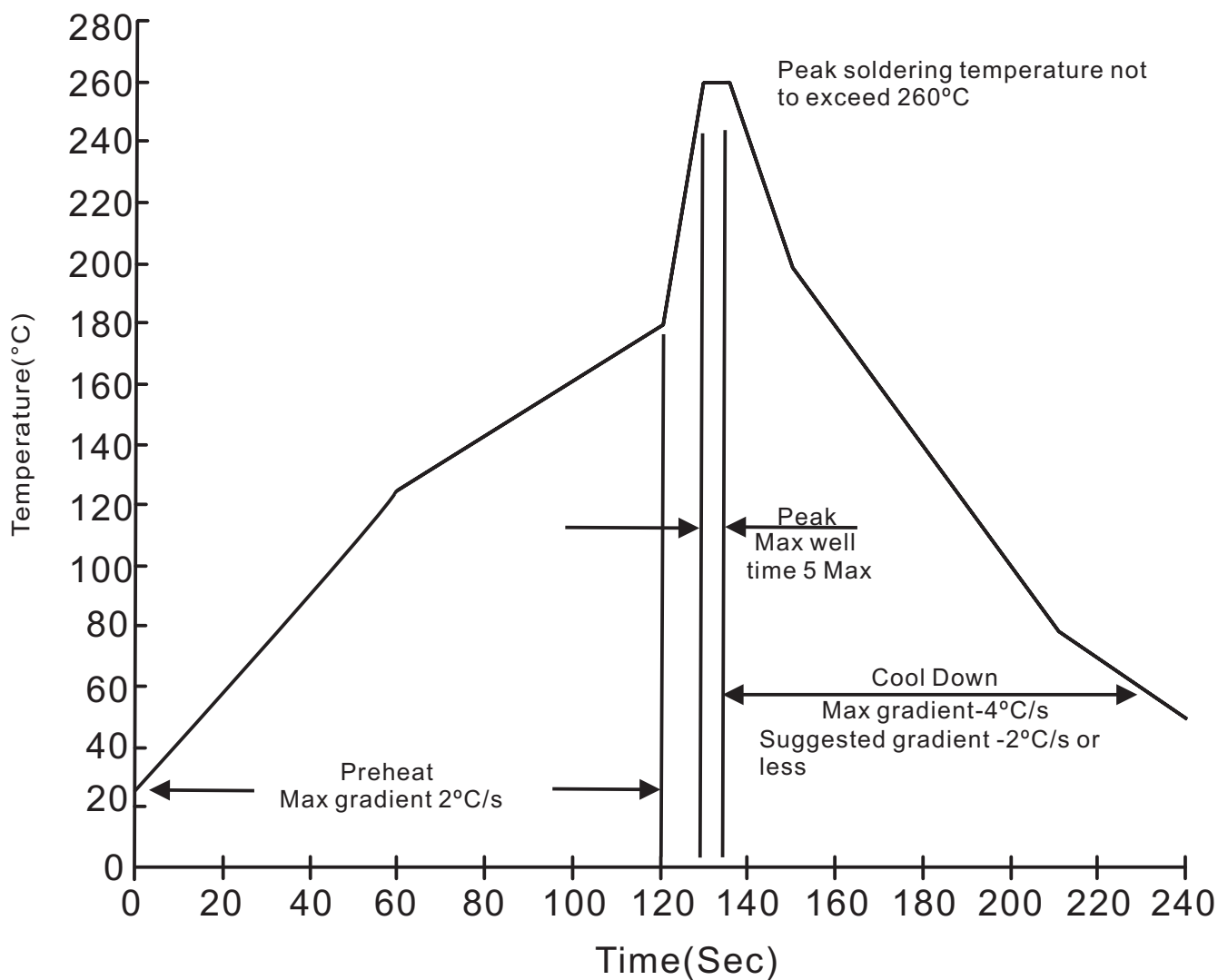

KBPC10005 THRU KBPC5010

High reliability test capabilities

Item Test	Conditions	Reference
1. Solder Resistance	at 260±5°C for 10±2sec. immerse body into solder 1/16"±1/32"	MIL-STD-750D METHOD-2031
2. Solderability	at 245±5°C for 5 sec.	MIL-STD-202F METHOD-208
3. High Temperature Reverse Bias	$V_R=80\%$ rate at $T_J=125^\circ\text{C}$ for 168 hrs.	MIL-STD-750D METHOD-1038
4. Forward Operation Life	Rated average rectifier current at $T_A=25^\circ\text{C}$ for 500hrs.	MIL-STD-750D METHOD-1027
5. Intermittent Operation Life	$T_A = 25^\circ\text{C}$, $I_F = I_o$ On state: power on for 5 min. off state: power off for 5 min. on and off for 500 cycles.	MIL-STD-750D METHOD-1036
6. Pressure Cooker	$15P_{SIG}$ at $T_A=121^\circ\text{C}$ for 4 hrs.	JESD22-A102
7. Temperature Cycling	-55°C to +125°C dwelled for 30 min. and transferred for 5min. total 10 cycles.	MIL-STD-750D METHOD-1051
8. Forward Surge	8.3ms single half sine-wave , one surge.	MIL-STD-750D METHOD-4066-2
9. Humidity	at $T_A=85^\circ\text{C}$, RH=85% for 1000hrs.	MIL-STD-750D METHOD-1021
10. High Temperature Storage Life	at 175°C for 1000 hrs.	MIL-STD-750D METHOD-1031