



MASTER INSTRUMENT CORPORATION

**SINGLE-PHASE BRIDGE RECTIFIER
KBPC3505NW THRU KBPC3510NW**

**VOLTAGE RANGE 50 to 1000 Volts
CURRENT 35 Amperes**

FEATURES

- I Low cost
- I This series is UL recognized under component index, file number E127707
- I High forward surge current capability
- I Integrally molded heatsink provide very low thermal resistance
- I High isolation voltage from case to leads
- I High temperature soldering guaranteed: 260°C/10 second, at 5 lbs. (2.3kg) tension.

MECHANICAL DATA

- I Case: Molded plastic body
- I Terminal: Plated lead 0.25"(6.35mm)lug.
- I Polarity: Polarity symbols marked on case
- I Mounting: Thru hole for #10 screw, 20 in.-lbs torque max.
- I Weight:0.47ounce, 13.4 grams

BR-35WN

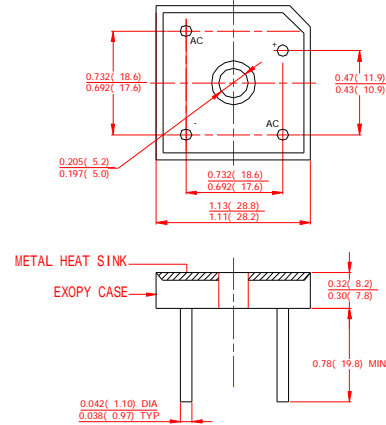

Dimensions in inches and (millimeters)

MAXIMUM RATINGS AND ELECTRICAL CHARACTERISTICS

Ratings at 25°C ambient temperature unless otherwise specified.
Single phase, half wave, 60Hz, resistive or inductive load.
For capacitive load derate current by 20%.

	SYMBOLS	KBPC 3505NW	KBPC 3501NW	KBPC 3502NW	KBPC 3504NW	KBPC 3506NW	KBPC 3508NW	KBPC 3510NW	UNITS	
Maximum Repetitive Peak Reverse Voltage	V_{RRM}	50	100	200	400	600	800	1000	Volts	
Maximum RMS Voltage	V_{RMS}	35	70	140	280	420	560	700	Volts	
Maximum DC Blocking Voltage	V_{DC}	50	100	200	400	600	800	1000	Volts	
Maximum Average Forward Rectified Output Current, at $T_C=50^\circ\text{C}$ (Note1)	$I_{(AV)}$	35							Amps	
Peak Forward Surge Current 8.3ms single half sine-wave superimposed on rated load (JEDEC Method)	I_{FSM}	400							Amps	
Rating for Fusing($t<8.3\text{ms}$)	I^2T	373							A^2S	
Maximum Instantaneous Forward Voltage at 17.5A	V_F	1.1							Volts	
Maximum DC Reverse Current at rated DC blocking voltage	I_R	$T_A=25^\circ\text{C}$	10							μAmps
		$T_A=100^\circ\text{C}$	1.0							mAmps
Isolation Voltage from case to leads	V_{ISO}	2500							V_{AC}	
Typical Thermal Resistance (Note 1, 2)	$R_{\theta JC}$	2.0							$^\circ\text{C}/\text{W}$	
Operating Temperature Range	T_J	-55 to +150							$^\circ\text{C}$	
Storage Temperature Range	T_{STG}	-55 to +150							$^\circ\text{C}$	

NOTES:

1. Unit mounted on 9"×3.5"×4.6" thick (23cm×9cm×11.8cm) Al. plate.
2. Bolt down on heat-sink with silicone thermal compound between bridge and mounting surface for maximum heat transfer efficiency with #10 screw.



MASTER INSTRUMENT CORPORATION

SINGLE-PHASE BRIDGE RECTIFIER
KBPC3505NW THRU KBPC3510NW

VOLTAGE RANGE 50 to 1000 Volts
CURRENT 35 Amperes

RATINGS AND CHARACTERISTIC CURVES KBPC3505NW THRU KBPC3510NW

