

KBU6005-G Thru. KBU610-G

Reverse Voltage: 50 to 1000V

Forward Current: 6.0A

RoHS Device

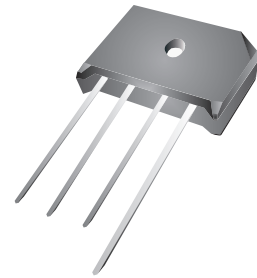

Features

- Surge overload rating - 175 amperes peak.
- Ideal for printed circuit board.
- Plastic material has U/L flammability classification 94V-0

Mechanical Data

- Case: Molded plastic, KBU
- Mounting position: Any
- Weight: 7.40grams

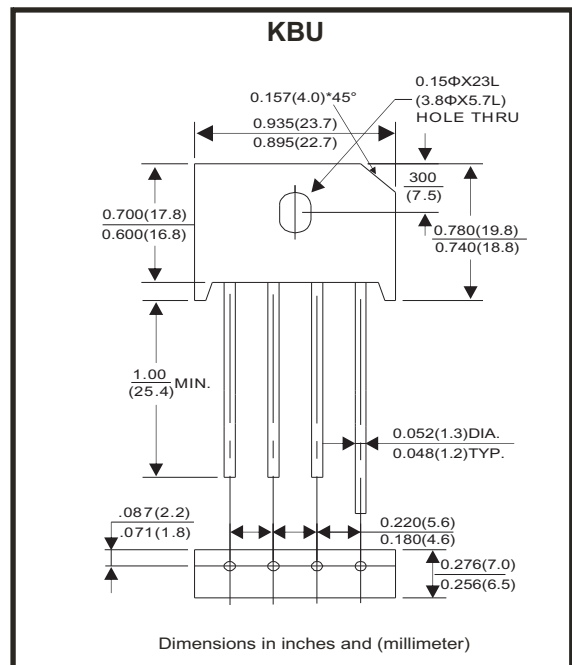

Maximum ratings and electrical characteristics

Rating at 25°C ambient temperature unless otherwise specified.
Single phase, half wave ,60Hz, resistive or inductive load.
For capacitive load, derate current by 20%

Parameter	Symbol	KBU 6005-G	KBU 601-G	KBU 602-G	KBU 604-G	KBU 606-G	KBU 608-G	KBU 610-G	Unit
Maximum Recurrent Peak Reverse Voltage	V_{RRM}	50	100	200	400	600	800	1000	V
Maximum RMS Voltage	V_{RMS}	35	70	140	280	420	560	700	V
Maximum DC Blocking Voltage	V_{DC}	50	100	200	400	600	800	1000	V
Maximum Average Forward Rectified Output Current @ $T_C=100^\circ C$	$I_{(AV)}$	6.0							A
Peak Forward Surge Current 8.3ms single Half Sine-Wave Super Imposed on Rated Load (JEDEC Method)	I_{FSM}	175							A
Maximum Instantaneous Forward Voltage Drop per Element at 3.0A	V_F	1.0							V
Maximum Reverse Leakage Current @ $T_J=25^\circ C$ At Rate DC Blocking Voltage @ $T_J=100^\circ C$	I_R	10 200							μA
Typical Junction Capacitance Per Element (Note1)	C_J	260							pF
Operating Temperature Range	T_J	-55 to +150							$^\circ C$
Storage Temperature Range	T_{STG}	-55 to +150							$^\circ C$

Notes:

1. Measured at 1.0MHz and applied reverse voltage of 4.0V DC.
2. Company reserves the right to improve product design , functions and reliability without notice.

Rating and Characteristics Curves (KBU6005-G Thru. KBU610-G)

Fig.1 - Derating Curve Output Rectified Current

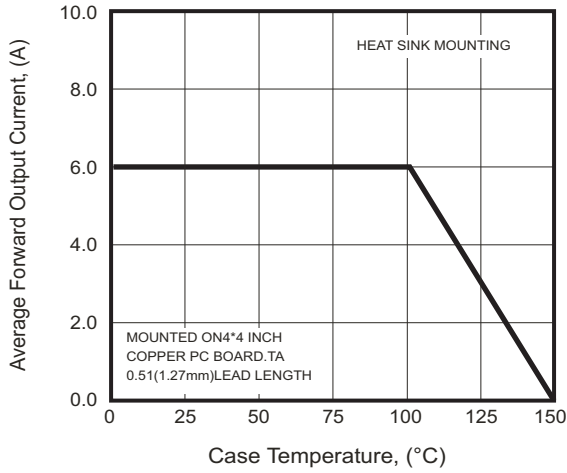

Fig.2 - Typical Forward Characteristics

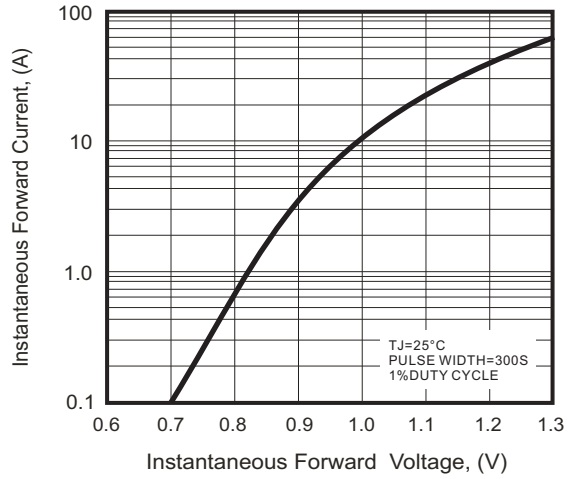

Fig.3 - Maximum Non-retetitive Peak Forward Surge Current

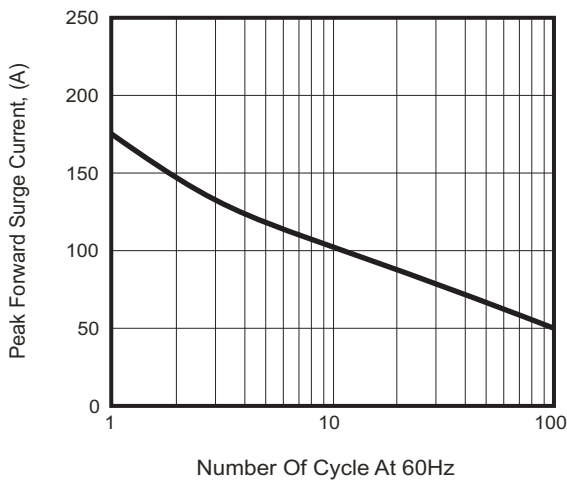

Fig.4 - Typical Junction Capacitance Per Element

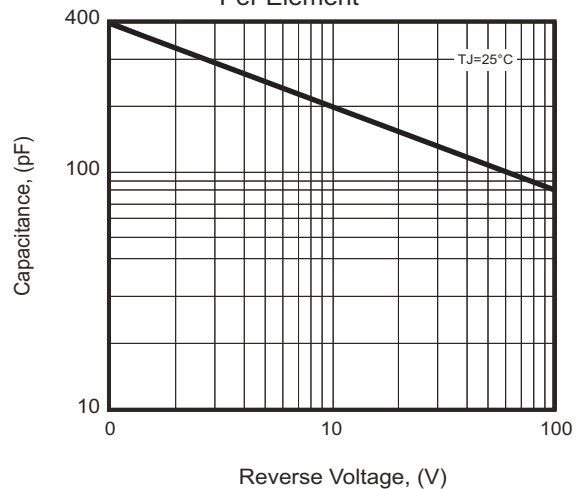
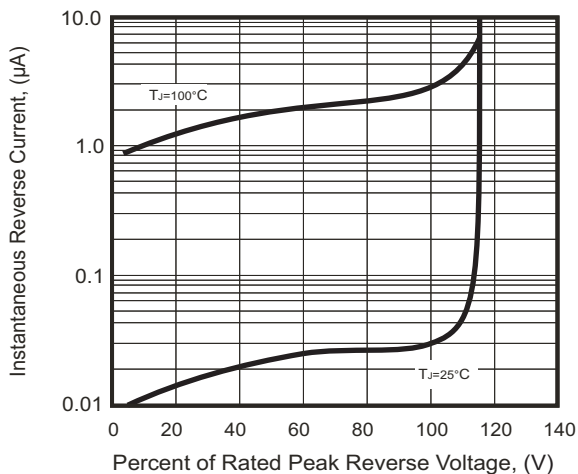
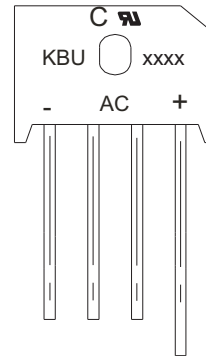

Fig.5 - Typical Reverse Characteristics



Marking Code

Part Number	Marking code
KBU6005-G	KBU6005
KBU601-G	KBU601
KBU602-G	KBU602
KBU604-G	KBU604
KBU606-G	KBU606
KBU608-G	KBU608
KBU610-G	KBU610



XXXX / XXXXX = Product type marking code
 C = Compchip Logo

Standard Packaging

Case Type	BULK PACK	
	BOX (pcs)	CARTON (pcs)
KBU	400	2,400