

JVC

DVD/CD RECEIVER

KD-DV5306/KD-DV5305/ KD-DV4306/KD-DV4305

ENGLISH

中文

DVD/CD 收音組合機

KD-DV5306/KD-DV5305/ KD-DV4306/KD-DV4305

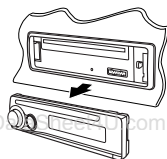

DOLBY
DIGITAL

WMA MP3 WAV

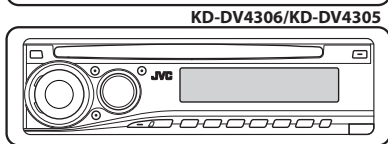
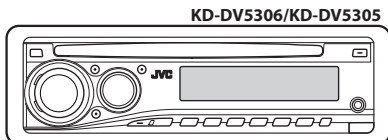
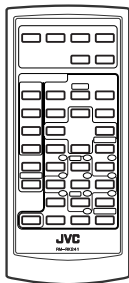

For canceling the display demonstration, see page 5.

取消屏幕演示功能，參閱第 5 頁。

For installation and connections, refer to the separate manual.

有關安裝和連接方法，分別參閱操作手冊。

INSTRUCTIONS

使用說明書

Thank you for purchasing a JVC product.

Please read all instructions carefully before operation, to ensure your complete understanding and to obtain the best possible performance from the unit.

IMPORTANT FOR LASER PRODUCTS

1. CLASS 1 LASER PRODUCT
2. **CAUTION:** Do not open the top cover. There are no user serviceable parts inside the unit; leave all servicing to qualified service personnel.
3. **CAUTION:** Visible and/or invisible class 1M laser radiation when open. Do not view directly with optical instruments.
4. REPRODUCTION OF LABEL: CAUTION LABEL, PLACED OUTSIDE THE UNIT.

CAUTION VISIBLE AND/OR INVISIBLE CLASS 1M LASER RADIATION WHEN OPEN. DO NOT VIEW DIRECTLY WITH OPTICAL INSTRUMENTS. IEC60825-1:2001 (EN6)	ATTENTION RAYONNEMENT LASER VISIBLE ET/OU INVISIBLE DE CLASSE 1M LORS QU'EST NE PAS REGARDER DIRECTEMENT AVEC DES INSTRUMENTS OPTIQUES. (FPA)	AVISO RADIACION LASER DE CLASE 1M VISIBLE Y/O INVISIBLE CUANDO ESTA ABIERTO. NO MIRAR DIRECTAMENTE CON INSTRUMENTAL OPTICO. (ESP)	VARNING SYNLIG OCH/ELLER OSYNLIG LASERSTRÅLNING, KLASS 1M, NÄR DENNA DEL ÄR ÖPPNAD. BETRÄKTA EJ STRÅLEN MED OPTISKA INSTRUMENT. (SVE)	注意 ここを覗くと可視 及び/または不可視 のクラス 1M レーザー放射が 出ます。 光学器械で直観 見ないでください。 (JPN)	CAUTION VISIBLE AND/OR INVISIBLE CLASS II LASER RADIATION WHEN OPEN. DO NOT STARE INTO BEAM. FDA 21 CFR (EN6)
--------------------------------------------------------------------------------------------------------------------------------------------------------------------------	------------------------------------------------------------------------------------------------------------------------------------------------------------------------------	------------------------------------------------------------------------------------------------------------------------------------------------------------------	----------------------------------------------------------------------------------------------------------------------------------------------------------------------	---------------------------------------------------------------------------------------------------	----------------------------------------------------------------------------------------------------------------------------------------------



This product incorporates copyright protection technology that is protected by U.S. patents and other intellectual property rights. Use of this copyright protection technology must be authorized by Macrovision, and is intended for home and other limited viewing uses only unless otherwise authorized by Macrovision. Reverse engineering or disassembly is prohibited.

How to reset your unit

- Your preset adjustments will also be erased.

How to forcibly eject a disc

- Be careful not to drop the disc when it ejects.
- If this does not work, reset your unit.

How to use functions mode

If you press M MODE, the unit goes into functions mode, then the number buttons and ▲/▼ buttons work as different function buttons.

WARNINGS:**To prevent accidents and damage**

- **DO NOT** install any unit in locations where;
 - it may obstruct the steering wheel and gearshift lever operations.
 - it may obstruct the operation of safety devices such as air bags.
 - it may obstruct visibility.
- **DO NOT** operate the unit while driving.
- If you need to operate the unit while driving, be sure to look ahead carefully.
- The driver must not watch the monitor while driving.
If the parking brake is not engaged, “DRIVER MUST NOT WATCH THE MONITOR WHILE DRIVING.” appears on the monitor, and no playback picture will be shown.
 - This warning appears only when the parking brake wire is connected to the parking brake system built in the car (refer to the Installation/Connection Manual).

Caution on volume setting

Discs produce very little noise compared with other sources. Lower the volume before playing a disc to avoid damaging the speakers by the sudden increase of the output level.

For safety...

- Do not raise the volume level too much, as this will block outside sounds, making driving dangerous.
- Stop the car before performing any complicated operations.

Temperature inside the car...

If you have parked the car for a long time in hot or cold weather, wait until the temperature in the car becomes normal before operating the unit.

CONTENTS**INTRODUCTIONS**

<i>Playable disc type</i>	4
<i>Preparation</i>	5

OPERATIONS

<i>Basic operations</i>	
• <i>Control panel</i>	6
• <i>Remote controller (RM-RK241)</i>	7
<i>Listening to the radio</i>	10
<i>Disc operations</i>	11

EXTERNAL DEVICES

<i>Listening to the CD changer</i>	19
<i>Listening to the iPod / D. player</i>	20
<i>Listening to the other external components</i>	21

SETTINGS

<i>Selecting a preset sound mode</i>	22
<i>General settings — PSM</i>	23
<i>Disc setup menu</i>	25
<i>Assigning titles</i>	27

REFERENCES

<i>Maintenance</i>	28
<i>More about this unit</i>	29
<i>Troubleshooting</i>	34
<i>Specifications</i>	36

The panel illustrations used in this manual are of KD-DV5306/KD-DV5305.

Playable disc type

Disc type	Recording format, file type, etc	Playable
DVD	DVD-Video (Region Code numbers include "3") *1 	✓OK
	DVD-Audio	✗NO
	DVD-ROM	
DVD Recordable/Rewritable (DVD-R *2/-RW, +R/+RW *3)	DVD-Video	✓OK
	DivX Video	
	MPEG-1/MPEG-2 Video	
	MP3/WMA/WAV	
	JPEG/MPEG4	✗NO
	DVD-VR, +VR	
DVD-RAM	All	✗NO
Dual Disc	DVD side	✓OK
	Non-DVD side	✗NO
CD/VCD	Audio CD (CD-DA)/DTS-CD *4	✓OK
	VCD (Video CD)	
	CD-Text	
	CD-ROM	✗NO
	CD-I (CD-I Ready)	
CD Recordable/Rewritable (CD-R/-RW) <ul style="list-style-type: none"> Compliant to ISO 9660 level 1, level 2, Romeo, Joliet 	CD-DA	✓OK
	DivX Video, VCD (Video CD)	
	MPEG-1/MPEG-2 Video	
	MP3/WMA/WAV	
	JPEG/MPEG4	✗NO

*1 If you insert a DVD Video disc of an incorrect Region Code, "REGION CODE ERROR!" appears on the monitor.

*2 DVD-R recorded in multi-border format is also playable (except for dual layer discs).

*3 It is possible to play back finalized +R/+RW (Video format only) discs. However, the use of +R double layer disc on this unit is not recommended.

*4 To reproduce DTS sound, use the DIGITAL OUT terminal (see also pages 26 and 31).

Caution for DualDisc playback

The Non-DVD side of a "DualDisc" does not comply with the "Compact Disc Digital Audio" standard. Therefore, the use of Non-DVD side of a DualDisc on this product may not be recommended.

Preparation

Cancel the display demonstration and set the clock

- See also page 24.

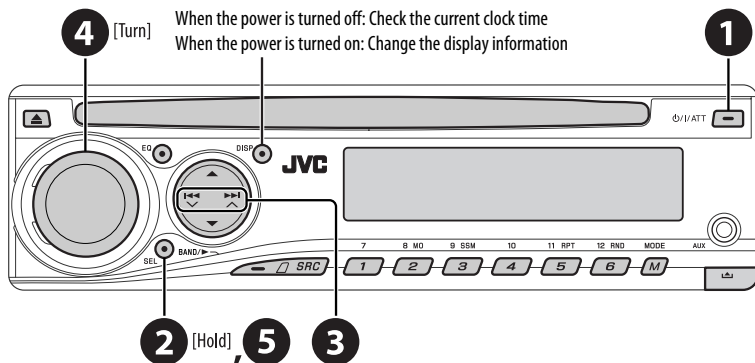

- 1** Turn on the power.
- 2** Enter the PSM settings.
- 3** → **4** Cancel the display demonstrations
Select "DEMO," then "DEMO OFF."
- Set the clock**
Select "CLOCK H" (hour), then adjust the hour.
Select "CLOCK M" (minute), then adjust the minute.
- 5** Finish the procedure.

Detaching the control panel

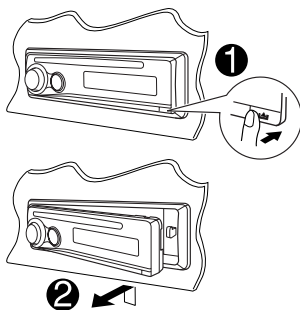

Attaching the control panel

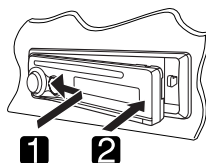

Basic operations — Control panel

- **FM/AM:** Select preset station.
- **DISC:** Select title/folder.
- **IPOD/D.PLAYER:** Enter the main menu/
Pause or stop playback/Confirm selection.

- **Turn on the power.**
- **Turn off the power** [Hold].
- **Attenuate the sound (if the power is on).**

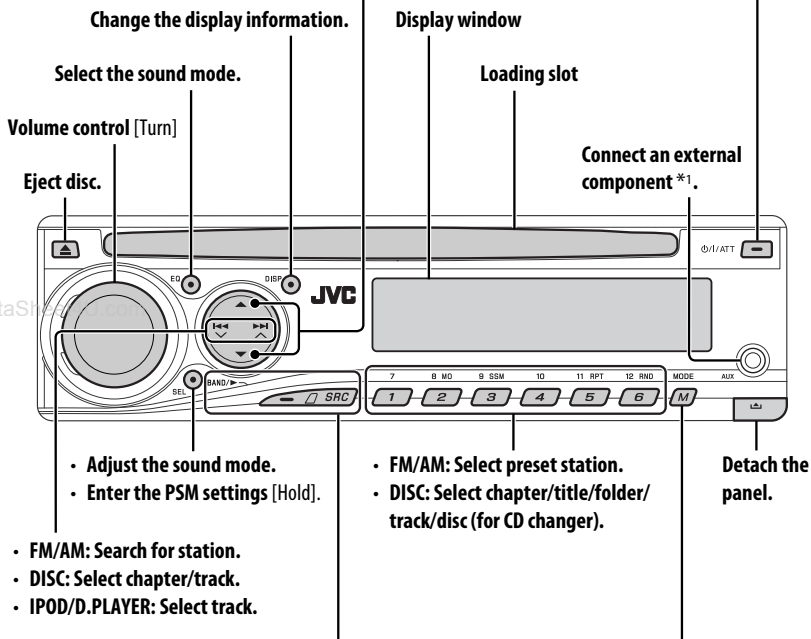

- **FM/AM:** Search for station.
- **DISC:** Select chapter/track.
- **IPOD/D.PLAYER:** Select track.

- **FM/AM:** Select preset station.
- **DISC:** Select chapter/title/folder/
track/disc (for CD changer).

Detach the panel.

BAND/▶

- **FM/AM:** Select the bands.
- **DISC:** Start playback.

SRC

Select the source.

FM/AM → **DISC** *2 → **CD-CH** *2/**IPOD** *2/
D.PLAYER *2 (or **EXT IN**) → **LINE IN** *1 →
AUX IN *1 → (back to the beginning)

Enter functions mode.

Press **M MODE**, then one of the following buttons (within 5 seconds)...

- MO** : Turn on/off monaural reception.
- SSM** : Automatic station presetting [Hold].
- RPT** : Select repeat play.
- RND** : Select random play.
- ▲/▼** : Skip 10 chapters/tracks.

*1 Only for KD-DV5306/KD-DV5305.

*2 You cannot select these sources if they are not ready or not connected.

Display window

Track information indicators

Playback mode/item indicators
(Random/Repeat)

Loudness indicator

Playback source indicators

Tuner reception indicators

Equalizer indicator

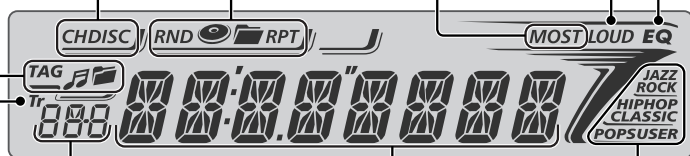
Source display/Preset No./Track No./
Folder No./Disc No./Chapter No.

Sound mode indicators

Track indicator

Main display

(Time, menu, playback information)

www.DataSheet4U.com

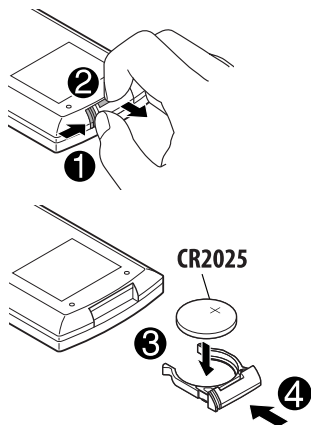
Basic operations — Remote controller (RM-RK241)**Installing the lithium coin battery
(CR2025)****Before using the remote controller:**

- Aim the remote controller directly at the remote sensor on the unit.
- DO NOT expose the remote sensor to bright light (direct sunlight or artificial lighting).

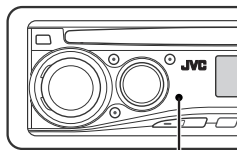

Remote sensor

www.DataSheet4U.com
Continued on the next page

Warning: To prevent accidents and damage

- Do not install any battery other than CR2025 or its equivalent.
- Do not leave the remote controller in a place (such as dashboards) exposed to direct sunlight for a long time; otherwise, it may explode.
- Store the battery in a place where children cannot reach.
- Do not recharge, short, disassemble, heat the battery, or dispose of it in a fire.
- Do not leave the battery with other metallic materials.
- Do not poke the battery with tweezers or similar tools.
- Wrap the battery with tape and insulate when throwing away or saving it.

EXTRA MONITOR

- 1 Monitor control buttons
 - Used for a JVC monitor—KV-MR9010, KV-MH6510, KV-M706, or KV-M705.

DVD/RECEIVER

- 2
 - Turns the power on if pressed briefly or attenuates the sound when the power is on.
 - Turns the power off if pressed and held.
- 3 Selects the source.
- 4 Selects the FM/AM bands.
- 5 Not applicable for this unit.
- 6 Not applicable for this unit.
- 7 Adjusts the volume level.
 - 2nd VOL: Not applicable for this unit.
- 8 *1
 - DVD-Video/DivX: Shows disc menu.
 - VCD: Starts PBC playback.
- 9 *1 Enters disc setup menu.
- 10 SHIFT button
- 11
 - (stop), ► (play), || (pause)
 - ► (play) also function as ZOOM button when pressed with SHIFT button (see page 15).
 - Not applicable for CD changer/iPod/D. player operations.
- 12 **For advanced disc operations:**
 - ▲ / ▼:
 - DVD-Video: Selects the titles.
 - DivX/MPEG Video/MP3/WMA/WAV: Selects the folders if included.
 - ◀◀ / ▶▶:
 - Reverse skip/forward skip if pressed briefly.
 - Reverse search/forward search if pressed and held.
 - ◀◀ / ▶▶: Reverse search/forward search. *2

For FM/AM tuner operations:

- ▲ / ▼: Changes the preset stations.
- ◀◀ / ▶▶:
 - Searches for stations automatically if pressed briefly.
 - Searches for stations manually if pressed and held.

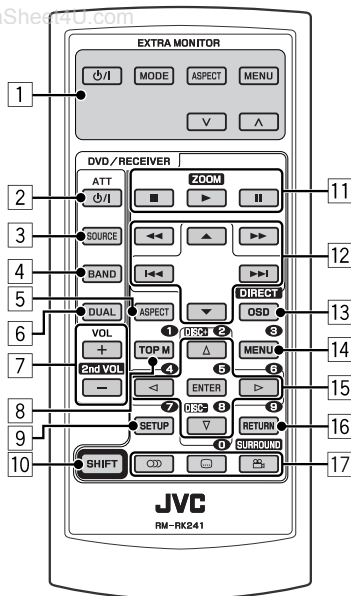

For Apple iPod/JVC D. player operations:

- **▼** : Pauses/stops or resumes playback.
- **▲** : Enters the main menu.
(Now **▲/▼/◀/▶** work as the menu selecting buttons.)*³
- **◀/▶** (in menu selecting mode):
 - Selects an item if pressed briefly. (Then, press **▼** to confirm the selection.)
 - Skips 10 items at a time if pressed and held.
- **◀/▶**:
 - Reverse skip/forward skip if pressed briefly.
 - Reverse search/forward search if pressed and held.

13 Shows the on-screen bar.

- Also functions as DIRECT button when pressed with SHIFT button. *⁴

14*¹ DVD-Video/DivX: Shows disc menu.

- VCD: Starts PBC playback.

15*¹ Makes selection/settings.

- **</>** : DivX: Searches for index during play.
- **DISC +/-** : Changes discs when the source is "CD-CH."

16*¹ RETURN button

- 17** • DVD-Video: Selects audio language (Ⓛ), subtitles (Ⓜ)*¹, angle (Ⓜ)*⁵.
- DivX: Selects audio language (Ⓛ), subtitles (Ⓜ).
- VCD: Selects audio channel (Ⓛ).

***1** Functions as number buttons when pressed with SHIFT button.

- **FM/AM**: Selects preset stations.
- **DISC**: Selects chapter/title/folder/track after entering search mode by pressing **SHIFT** and **DIRECT**.

2** Not applicable for CD changer operations.3** **▲** : Returns to the previous menu.

- **▼** : Confirms the selection.

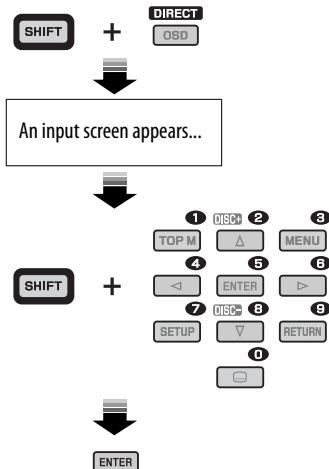
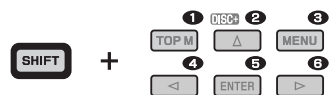
4** You can directly select title/chapter/folder/track using the number buttons (see pages 13 – 15).5** Functions as SURROUND button when pressed with SHIFT button (not applicable for this unit).**How to select a number****How to select a preset station**

Listening to the radio

Change the display information

Clock → Station name* → Frequency

* If no name is assigned to a station, "NO NAME" appears. To assign a name to a station, see page 27.

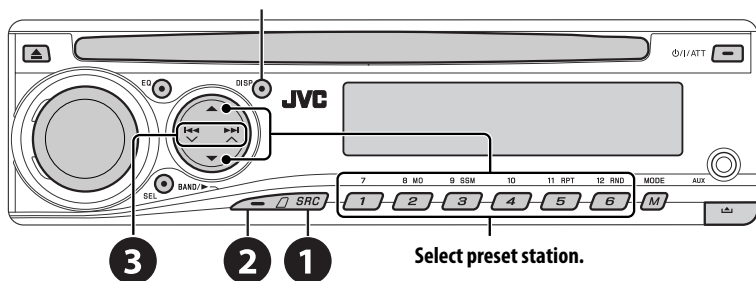

1 Select "FM/AM."

2 Select the bands.

FM1 → FM2 → FM3 → AM

3 Search for a station to listen—Auto Search.

Manual Search: Hold either one of the buttons until "M" flashes on the display, then press it repeatedly.

Lights up when receiving an FM stereo broadcast with sufficient signal strength.



When an FM stereo broadcast is hard to receive

1 MODE
M

2 B MO
2

MONO → MONO OFF
(Canceled)

Reception improves, but stereo effect will be lost.

- MO indicator lights up.

FM station automatic presetting—SSM (Strong-station Sequential Memory)

You can preset six stations for each band.

1 BAND/▶

FM1 → FM2 → FM3 → AM

2 MODE
M

3 9 SSM
3 [Hold]



Local FM stations with the strongest signals are searched and stored automatically in the FM band.

Manual presetting

Ex.: Storing FM station of 92.5 MHz into preset number 4 of the FM1 band.

1 BAND/▶

FM1 → FM2 → FM3 → AM



92.5

3 10
4 [Hold]



Disc operations

Before performing any operations...

Turn on the monitor to watch the playback picture. If you turn on the monitor, you can also control playback of other discs by referring to the monitor screen. (See pages 15 – 18.)

The disc type is automatically detected, and playback starts automatically (for DVD: automatic start depends on its internal program).

If the current disc does not have any disc menu, all tracks will be played repeatedly until you change the source or eject the disc.

If “” appears on the monitor when pressing a button, the unit cannot accept the operation you have tried to do.

- In some cases, without showing “,” operations will not be accepted.



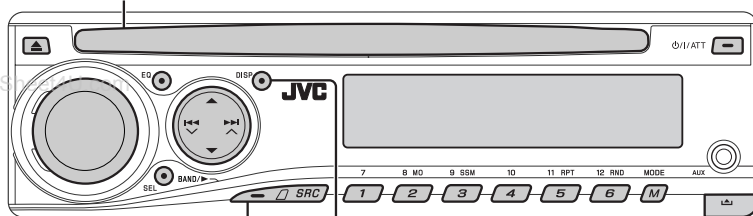

Insert the disc.

Playback starts automatically.



Start playback if necessary.

Change the display information

	Elapsed playing time → Clock → Current title and chapter number
	Elapsed playing time → Clock Track title ← Folder name ←
	Elapsed playing time and Current track number → Clock and Current track number
	Elapsed playing time and Current track number → Clock and Current track number Track title ← Album name/performer (file name*1) ← (folder name*1) ←
	Elapsed playing time and Current track number → Clock and Current track number Track title*2 ← Disc title/performer*2 ←

Prohibiting disc ejection











To cancel the prohibition, repeat the same procedure.

*1 If the file does not have Tag information or “TAG DISP” is set to “TAG OFF” (see page 24), folder name and file name appear. TAG indicator will not light up.

*2 “NO NAME” appears for an audio CD.

Operations using the control panel

Pressing (or holding) the following buttons allows you to...









Disc type			 (Number buttons)*3
 DVD Video	Press: Select chapter Hold: Reverse/fast-forward chapter*1	Select title	During stop: Locate title During play/pause: Locate chapter
 DivX/MPEG	Press: Select track Hold: Reverse/fast-forward track*2	Select folder	Locate particular folder directly
 VCD	Press: Select track Hold: Reverse/fast-forward track*1	—	Locate particular track directly (PBC not in use)
 MP3/WMA/WAV	Press: Select track Hold: Reverse/fast-forward track*1	Select folder	Locate particular folder directly
 CD	Press: Select track Hold: Reverse/fast-forward track*1	—	Locate particular track directly

*1 Search speed changes to $\times 2 \Leftrightarrow \times 10$ on the monitor.

*2 Search speed changes $\blacktriangleright 1 \Leftrightarrow \blacktriangleright 2$ on the monitor.

*3 Press to select number 1 to 6; hold to select number 7 to 12.

After pressing ^{MODE}, press the following buttons to...

Disc type		 11 RPT	 12 RND
 DVD Video	Skip 10 chapters (during play or pause)	CHP RPT: Repeat current chapter TIT RPT: Repeat current title	—
 DivX/MPEG	Skip 10 tracks (within the same folder)	TRK RPT: Repeat current track FLDR RPT: Repeat current folder	—
 VCD	Skip 10 tracks (PBC not in use)	TRK RPT: Repeat current track (PBC not in use)	DISC RND: Randomly play all tracks (PBC not in use)
 MP3/WMA/WAV	Skip 10 tracks (within the same folder)	TRK RPT: Repeat current track FLDR RPT: Repeat current folder	FLDR RND: Randomly play all tracks of current folder, then tracks of next folders DISC RND: Randomly play all tracks
 CD	Skip 10 tracks	TRK RPT: Repeat current track	DISC RND: Randomly play all tracks

• To cancel repeat play or random play, select "RPT OFF" or "RND OFF."

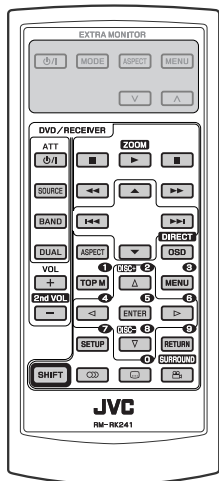

*1, 2, 3, 4, 5: See page 14.

- : Stop play
- : Pause (Frame by frame playback if pressed during pause.)
- : Start play
- : Reverse/forward chapter search *1
 - Slow motion *2 during pause. No sound can be heard.
- : Press: Select chapter (during play or pause)
Hold: Reverse/fast-forward chapter search *3
- : Select title
- : Select audio language
- : Select subtitle language
- : Select view angle



To search for chapter/title directly

- 1 Select chapter/title search.

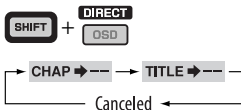

- 2 Enter the desired number.

+

- 3

Using menu driven features...

- 1
- 2 Select an item you want to start play.



- 3

- : Stop play
- : Pause (Frame by frame playback if pressed during pause.)
- : Start play
- : Reverse/forward track search *4
- : Press: Select track
Hold: Reverse/fast-forward track search *5
- : Select folder
- : • Return/advance the scenes by about 5 minutes (Index search).
• Select chapter.
- : DivX: Select subtitles language
- : DivX: Select audio language



To search for track (within the same folder)/ folder directly



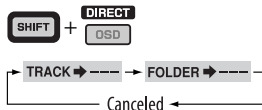



- 1 Select track/folder search.



- 2 Enter the desired number.











+







- 3

-  : Stop play
-  : Pause (Frame by frame playback if pressed during pause.)
-  : Start play
-  : Reverse/forward track search *1
 - Forward slow motion *2 during pause. No sound can be heard. (Reverse slow motion does not work.)
-   : *Press:* Select track
Hold: Reverse/fast-forward track search *3
-  : Select audio channel (ST: stereo, L: left, R: Right)



Canceling the PBC playback...

- 1 
 - 2  +  
 - 3 Enter the desired number.
 +  ... 
 - 4 
- To resume PBC, press  / .

-  : Stop play
-  : Pause
-  : Start play
-  : Reverse/forward track search *1
-  : *Press:* Select tracks
Hold: Reverse/fast-forward track search *3
-   : Select folder

To search for track (within the same folder)/folder directly





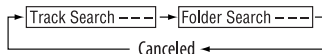

- 1 Select track/folder search.



- 2 Enter the desired number.



- 3 

-  : Stop play
-  : Pause
-  : Start play
-  : Reverse/forward track search *1
-  : *Press:* Select tracks
Hold: Reverse/fast-forward track search *3

To search for track directly



- 1 Select track search.



- 2 Enter the desired number.



- 3 

*1 Search speed changes to $\times 2 \Rightarrow \times 5 \Rightarrow \times 10 \Rightarrow \times 20 \Rightarrow \times 60$ on the monitor if pressed repeatedly.

*2 Slow motion speed changes to $\text{▶}1/32 \Rightarrow \text{▶}1/16 \Rightarrow \text{▶}1/8 \Rightarrow \text{▶}1/4 \Rightarrow \text{▶}1/2$ on the monitor if pressed repeatedly.

*3 Search speed changes to $\times 2 \Rightarrow \times 10$ on the monitor.

*4 Search speed changes $\text{▶}1 \Rightarrow \text{▶}2 \Rightarrow \text{▶}3$ on the monitor if pressed repeatedly.

*5 Search speed changes $\text{▶}1 \Rightarrow \text{▶}2$ on the monitor.

Enlarging the view—Zoom in (DVD/DivX/MPEG Video/VCD)

During moving picture playback...

- While holding **SHIFT**, press **ZOOM** repeatedly.

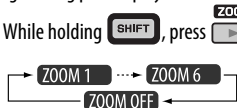

- Move the enlarged portion.



- To cancel zoom, select "ZOOM OFF."

Operations using the on-screen bar (DVD/DivX/MPEG Video/VCD)

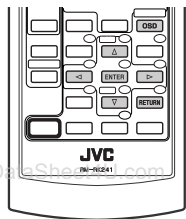

These operations are possible on the monitor using the remote controller.

- Show the on-screen bar (see page 16).

OSD (twice)

- Select an item.



- Make a selection.

ENTER

If pop-up menu appears...



- To cancel pop-up menu, press **RETURN**.
- For entering time/numbers, see the following.

- Remove the on-screen bar.

OSD

Entering time/numbers

Press **▲** **▼** to change the number, then press **◀** **▶** to move to the next entry.

- Each time you press **▲** **▼**, the number increases/decreases by one value.
- After entering the numbers, press **ENTER**.
- It is not required to enter the zero and trailing zeros (the last two digits in the example below).

Ex.: Time search

DVD: **._.:** (Ex.: 1:02:00)

Press **▲** once, then **▶** twice to go to the third entry, **▲** twice, then press **ENTER**.

On-screen bar

Ex.: DVD-Video

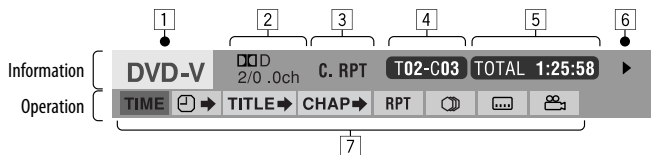

- 1** Disc type
- 2** • DVD-Video/DTS-CD: Audio signal format type and channel
• VCD: PBC
- 3** Playback mode *¹
DVD-Video: **T. RPT:** Title repeat
C. RPT: Chapter repeat
DivX/MPEG Video: **T. RPT:** Track repeat
F. RPT: Folder repeat
VCD *²: **T. RPT:** Track repeat
D. RND: Disc random
T. INT: Track intro *³
- 4** Playback information
T02-C03 Current title/chapter
TRACK 01 Current track
F001-T001 Current folder/track
- 5** Time indication
TOTAL Elapsed playing time of the disc (For DVD-Video, elapsed playing time of the current title.)
T. REM DVD-Video: Remaining title time
VCD: Remaining disc time
TIME Elapsed playing time of the current chapter/track
REM Remaining time of the current chapter/track
- 6** Playback status
▶ Play
▶▶/◀◀ Forward/reverse search
|▶/◀| Forward/reverse slow-motion
|| Pause
■ Stop
- 7** Operation icons
TIME Change time indication (see **5**)
▶▶ Time Search (Enter the elapsed playing time of the current title or of the disc.)
TITLE▶ Title Search (by its number)
CHAP▶ Chapter Search (by its number)
TRACK▶ Track Search (by its number)
🔊 Change the audio language or audio channel
📄 Change the subtitle language
📺 Change the view angle
RPT Repeat play *¹
INT Intro play *³
RND Random play *¹

*¹ For repeat play/random play, see also page 12.*² While PBC is not in use.*³ Plays the beginning 15 seconds of...**TRACK INTRO:** All tracks of the current disc.**FOLDER INTRO:** First tracks of all folders of the current disc.

Operations using the control screen (DivX/MPEG Video/MP3/WMA/WAV/CD)

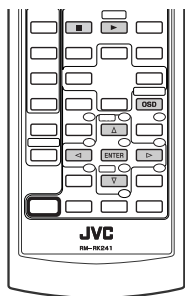

These operations are possible on the monitor using the remote controller.

- Show the control screen.**
 DivX/MPEG Video: Press during play.
 MP3/WMA/WAV/CD: Automatically appear during play.
- Select "Folder" column or "Track" column (except for CD).**
- Select a folder or track.**
- Start playback.**
 DivX/MPEG Video: Press / .
 MP3/WMA/WAV/CD: Playback starts automatically.

Control screen

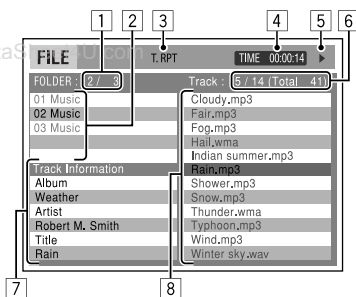

Ex.: MP3/WMA/WAV disc

- Current folder number/total folder number
- Folder list with the current folder selected
- Selected playback mode
- Elapsed playing time of the current track
- Operation mode icon (, , , , , ,)
- Current track number/total number of tracks in the current folder (total number of tracks on the disc)
- Track information
- Track list with the current track selected

To select a playback mode

- While control screen is displayed...

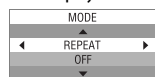

Playback mode selection screen appears on the folder list section of the control screen.

- Select a playback mode.



- Select an item.



REPEAT/INTRO:

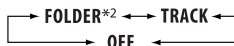

RANDOM:

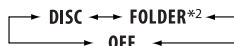

- Confirm the selection.



*1 Not selectable for DivX/MPEG Video

*2 Not selectable for CD

Mode	Playback functions
F. RPT (folder repeat):	Repeat current folder
T. RPT (track repeat):	Repeat current track
F. INT (folder intro):	Plays the beginning 15 seconds of first tracks of all folders of the current disc
T. INT (track intro):	Plays the beginning 15 seconds of all tracks of the current disc
D. RND (disc random):	Randomly play all tracks
F. RND (folder random):	Randomly play all tracks of current folder, then tracks of next folders

Operations using the list screen (DivX/MPEG Video/MP3/WMA/WAV)

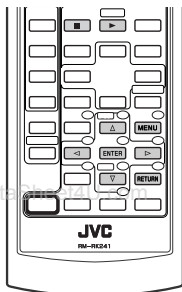

These operations are possible on the monitor using the remote controller. Before playing, you can display the folder list/track list to confirm the contents and start playing a track.

1 Display the folder list while stop.



2 Select an item from the folder list.



- Track list of the selected folder appears.
- To go back to the folder list, press **RETURN**.

3 Select a track to start playing.



- MP3/WMA/WAV: Control screen appears (see page 17).

List screen

Folder: 153/240		Track: 154/198		Page: 4/ 6	
fol130	fol140	fol150	fol160		
fol131	fol141	fol151	fol161		
fol132	fol142	fol152	fol162		
fol133	fol143	fol153	fo163		
fol134	fol144	fol154	fo164		
fol135	fol145	fol155	fo165		
fol136	fol146	fol156	fo166		
fol137	fol147	fol157	fo167		
fol138	fol148	fol158	fo168		
fol139	fol149	fol159	fo169		

Ex.: Folder list

- 1 Current folder number/total folder number
- 2 Current track number/total number of tracks in the current folder
- 3 Current page/total number of the pages included in the list
- 4 Current folder/track (highlighted bar)

Listening to the CD changer

Change the display information

(see page 11)

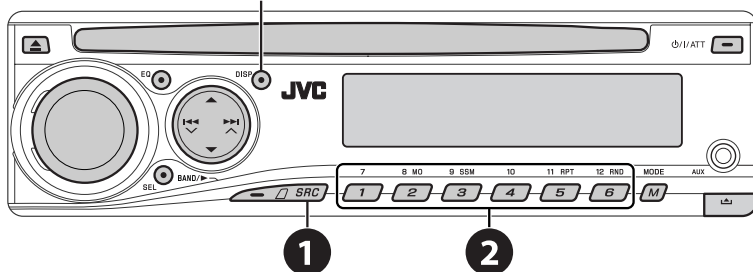

It is recommended to use a JVC MP3-compatible CD changer with your unit.

- You can only play conventional CDs (including CD Text) and MP3 discs.

www.DataSheet4U.com

1 Select "CD-CH."

2 Select a disc to start playing.

Press: For selecting disc number 1 – 6.

Hold: For selecting disc number 7 – 12.

	<i>Press:</i> Select track <i>Hold:</i> Reverse/fast-forward track
	MP3: Select folders

After pressing **MODE** **M**, press the following buttons to...

	Skip 10 tracks (MP3: within the same folder)
	TRK RPT: Repeat current track FLDR RPT: MP3: Repeat all tracks of current folder DISC RPT: Repeat all tracks of the current disc
	FLDR RND: MP3: Randomly play all tracks of the current folder, then tracks of the next folder DISC RND: Randomly play all tracks of current disc MAG RND: Randomly play all tracks of the inserted discs

- To cancel repeat play or random play, select "RPT OFF" or "RND OFF."

Listening to the iPod/D. player

Change the display information

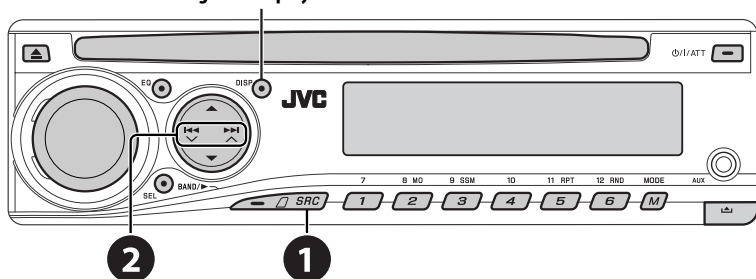

Before operating, connect either one of the following (separately purchased) to the CD changer jack on the rear of this unit.

- **Interface adapter for iPod**—KS-PD100 for controlling an iPod.
- **D. player interface adapter**—KS-PD500 for controlling a D. player.

Preparations

Make sure "CHANGER" is selected for the external input setting, see page 24.

- 1 Select "IPOD" or "D. PLAYER."
- 2 Select a song to start playing.

Selecting a track from the menu

1 Enter the main menu.



- This mode will be canceled if no operations are done for about 5 seconds.

2 Select the desired menu.



For iPod:

PLAYLIST ↔ ARTISTS ↔ ALBUMS ↔ SONGS
 ↔ GENRES ↔ COMPOSER ↔ (back to the beginning)

For D. player:

PLAYLIST ↔ ARTIST ↔ ALBUM ↔ GENRE
 ↔ TRACK ↔ (back to the beginning)

3 Confirm the selection.



- To move back to the previous menu, press ▲.
- If a track is selected, playback starts automatically.
- Holding ◀◀ ▼/▶▶ ▶ can skip 10 items at a time.



Pause/stop playback

- To resume playback, press the button again.



Press: Select tracks

Hold: Reverse/fast-forward track

After pressing **MODE** **M**, press the following buttons to...

11 RPT 5	ONE RPT: Functions the same as "Repeat One" or "Repeat Mode → One." ALL RPT: Functions the same as "Repeat All" or "Repeat Mode → All."
12 RND 6	ALBM RND* : Functions the same as "Shuffle Albums" of the iPod. SONG RND/RND ON: Functions the same as "Shuffle Songs" or "Random Play → On."

• To cancel repeat play or random play, select "RPT OFF" or "RND OFF."

* iPod: Functions only if you select "ALL" in "ALBUMS" of the main "MENU."

Listening to the other external components

Change the display information

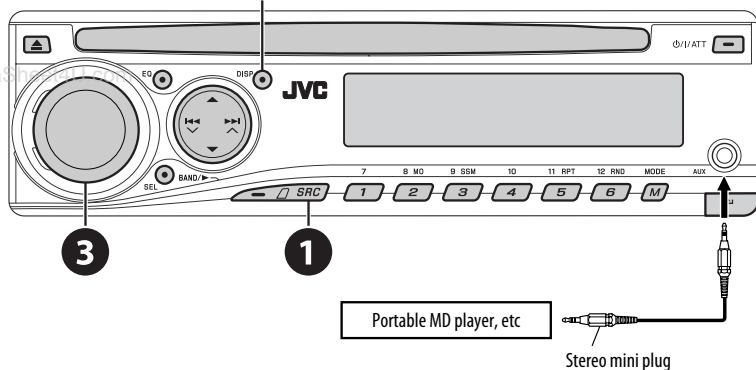

You can connect an external component to:

- CD changer jack on the rear using the **Line Input Adapter**—KS-U57 (not supplied) or **AUX Input Adapter**—KS-U58 (not supplied). Make sure "EXT IN" is selected for the external input setting, see page 24.
- LINE IN plugs on the rear (for KD-DV5306/KD-DV5305).
- AUX input terminal on the control panel (for KD-DV5306/KD-DV5305).

- 1 Select "EXT IN," "LINE IN," or "AUX IN."
- 2 Turn on the connected component and start playing the source.
- 3 Adjust the volume.
- 4 Adjust the sound as you want (see pages 22 and 23).

Selecting a preset sound mode

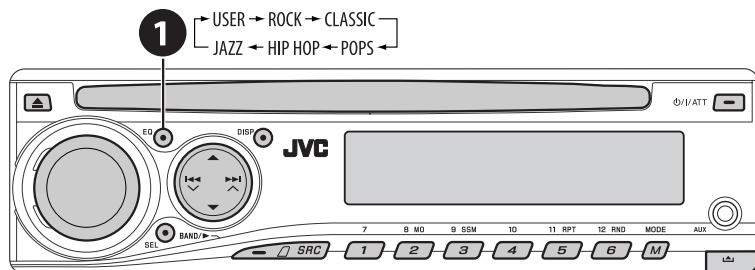

Indication (For)	Preset values	BAS (bass)	TRE (treble)	LOUD (loudness)
USER (Flat sound)		00	00	OFF
ROCK (Rock or disco music)		+03	+01	ON
CLASSIC (Classical music)		+01	-02	OFF
POPS (Light music)		+04	+01	OFF
HIP HOP (Funk or rap music)		+02	00	ON
JAZZ (Jazz music)		+02	+03	OFF

Adjusting the sound



2 Adjust the level.



BAS * ¹ (bass) Adjust the bass.	-06 to +06
TRE * ¹ (treble) Adjust the treble.	-06 to +06
FAD * ² (fader) Adjust the front and rear speaker balance.	R06 to F06
BAL (balance) Adjust the left and right speaker balance.	L06 to R06
LOUD * ¹ (loudness) Boost low and high frequencies to produce a well-balanced sound at low volume level.	LOUD ON or LOUD OFF
VOL.A * ³ (volume adjust) Adjust and store auto-adjustment volume level for each source, comparing to the FM volume level.	-05 to +05; initial: 00
VOL (volume) Adjust the volume.	00 to 30 (or 50) * ⁴

*¹ When you adjust the bass, treble, or loudness, the adjustment you have made is stored for the currently selected sound mode (C-EQ) including "USER."

*² If you are using a two-speaker system, set the fader level to "00."

*³ You cannot make an adjustment for FM. "FIX" appears.

*⁴ Depending on the amplifier gain control setting. (See page 24 for details.)

General settings — PSM

You can change PSM (Preferred Setting Mode) items listed in the table on page 24.

1 Enter the PSM settings.



2 Select a PSM item.



3 Select or adjust the selected PSM item.



4 Repeat steps 2 and 3 to adjust other PSM items if necessary.

5 Finish the procedure.



Indication	Item (___ : Initial)	Setting, [reference page]
DEMO Display demonstration	<ul style="list-style-type: none"> • DEMO ON • DEMO OFF 	<ul style="list-style-type: none"> : Display demonstration will be activated automatically if no operation is done for about 20 seconds, [5]. : Cancels.
CLK DISP *1 Clock display	<ul style="list-style-type: none"> • ON • OFF 	<ul style="list-style-type: none"> : Clock time is shown on the display at all times when the power is turned off. : Cancels; pressing DISP will show the clock time for about 5 seconds when the power is turned off, [5].
CLOCK H Hour adjustment	1 – 12	: Initial: 1 (1:00), [5].
CLOCK M Minute adjustment	00 – 59	: Initial: 00 (1:00), [5].
DIMMER Dimmer	<ul style="list-style-type: none"> • ON • OFF 	<ul style="list-style-type: none"> : Dims the display illumination. : Cancels.
SCROLL *2 Scroll	<ul style="list-style-type: none"> • ONCE • AUTO • OFF 	<ul style="list-style-type: none"> : Scrolls the track information once. : Repeats scrolling (at 5-second intervals). : Cancels. (Holding DISP can scroll the display regardless of the setting.)
EXT IN *3 External input	<ul style="list-style-type: none"> • CHANGER • EXT IN 	<ul style="list-style-type: none"> : To use a JVC CD changer, [19], or an Apple iPod/a JVC D. player, [20]. : To use any other external component than the above, [21].
TAG DISP Tag display	<ul style="list-style-type: none"> • TAG ON • TAG OFF 	<ul style="list-style-type: none"> : Shows the tag while playing MP3/WMA/WAV tracks. : Cancels.
VIDEO *4 Video format	<ul style="list-style-type: none"> • PAL • NTSC 	<ul style="list-style-type: none"> : Select this if your monitor is of the PAL color system. : Select this if your monitor is of the NTSC color system.
AMP GAIN Amplifier gain control	<ul style="list-style-type: none"> • LOW PWR • HIGH PWR 	<ul style="list-style-type: none"> : VOL 00 – VOL 30 (Select if the maximum power of each speaker is less than 50 W to prevent damaging the speaker.) : VOL 00 – VOL 50
IF BAND Intermediate frequency band	<ul style="list-style-type: none"> • AUTO • WIDE 	<ul style="list-style-type: none"> : Increases the tuner selectivity to reduce interference noises between adjacent stations. (Stereo effect may be lost.) : Subject to interference noises from adjacent stations, but sound quality will not be degraded and the stereo effect will remain.

*1 If the power supply is not interrupted by turning off the ignition key of your car, it is recommended to select "OFF" to save the car's battery.

*2 Some characters or symbols will not be shown correctly (or will be blanked) on the display.

*3 Displayed only when one of the following sources is selected—FM, AM, DISC, and also LINE IN or AUX IN for KD-DV5306/KD-DV5305.

*4 The newly selected video format takes effect only after you turn on the power again or change the source.

Disc setup menu

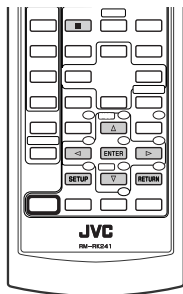

These operations are possible on the monitor using the remote controller.

- 1 Enter the disc setup menu while stop.



- 2 Select a menu.

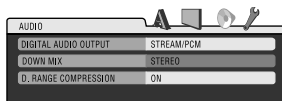
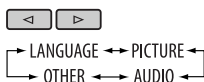

- 3 Select an item you want to set up.

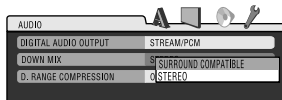

• To cancel pop-up menu, press **RETURN**.

- 4 Select an option.



To return to normal screen



www.DataSheet4U.com

Menu	Item	Setting
LANGUAGE	MENU LANGUAGE	Select the initial disc menu language. Refer also to "Language codes" on page 33.
	AUDIO LANGUAGE	Select the initial audio language. Refer also to "Language codes" on page 33.
	SUBTITLE	Select the initial subtitle language or remove the subtitle (OFF). Refer also to "Language codes" on page 33.
	ON SCREEN LANGUAGE	Select the language for the on screen display.

Menu	Item	Setting
PICTURE	MONITOR TYPE	<p>Select the monitor type to watch a wide screen picture on your monitor.</p> <p>16:9 4:3 LETTER BOX 4:3 PAN SCAN</p> 
	OSD POSITION	<p>Select the on-screen bar position on the monitor.</p> <ul style="list-style-type: none"> • 1 : Higher position • 2 : Lower position (Guidance below the disc setup menu will disappear.)
	FILE TYPE	<p>Select the file type to play.</p> <ul style="list-style-type: none"> • AUDIO : Play MP3/WMA/WAV files. • VIDEO : Play DivX/MPEG Video files.
AUDIO	DIGITAL AUDIO OUTPUT	<p>Select the signal format to be emitted through the DIGITAL OUT (Optical) terminal.</p> <ul style="list-style-type: none"> • OFF : Cancels. • PCM ONLY : Select for an amplifier or a decoder incompatible with Dolby Digital, DTS, MPEG Audio, or when connecting to a recording device. • DOLBY DIGITAL/PCM : Select for an amplifier or a decoder compatible with Dolby Digital. • STREAM/PCM : Select for an amplifier or a decoder compatible with Dolby Digital, DTS, and MPEG Audio.
	DOWN MIX	<p>When playing back a multi-channel disc, this setting affects the signals reproduced through the LINE OUT jacks (and through the DIGITAL OUT terminal when "PCM ONLY" is selected for "DIGITAL AUDIO OUTPUT").</p> <ul style="list-style-type: none"> • SURROUND COMPATIBLE: Select to enjoy multi-channel surround audio by connecting an amplifier compatible with Dolby Surround. • STEREO : Normally select this.
	D. RANGE COMPRESSION	<p>You can enjoy a powerful sound at low or middle volume levels while playing a Dolby Digital software.</p> <ul style="list-style-type: none"> • AUTO : Select to apply the effect to multi-channel encoded software (excluding 1-channel and 2-channel software). • ON : Select to always use this function.
OTHER	DivX REGISTRATION	<p>This unit has its own Registration Code. Once you have played back a disc in which the Registration Code recorded, this unit's Registration Code is overwritten for copyright protection.</p>

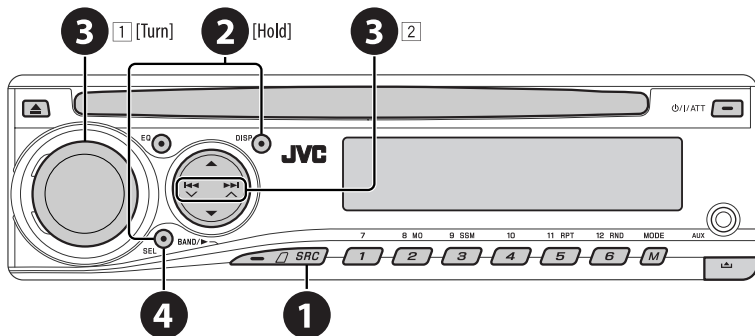

You can assign titles to 30 station frequencies (FM and AM) and up to 8 characters for each title.

- 1 **Select FM/AM.**
- 2 **Show the title entry screen.**
- 3 **Assign a title.**
 - 1 Select a character.
 - 2 Move to the next (or previous) character position.
 - 3 Repeat steps 1 and 2 until you finish entering the title.
- 4 **Finish the procedure.**

To erase the entire title

In step 2 on the left...



Available characters

A	B	C	D	E	F	G	H	I	J	K	L	M	N
O	P	Q	R	S	T	U	V	W	X	Y	Z	0	1
2	3	4	5	6	7	8	9	-	/	<	>	space	

Maintenance

How to clean the connectors

Frequent detachment will deteriorate the connectors. To minimize this possibility, periodically wipe the connectors with a cotton swab or cloth moistened with alcohol, being careful not to damage the connectors.

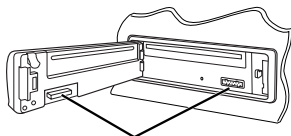

Connector

Moisture condensation

Moisture may condense on the lens inside the unit in the following cases:

- After starting the heater in the car.
- If it becomes very humid inside the car.

Should this occur, the unit may malfunction. In this case, eject the disc and leave the unit turned on for a few hours until the moisture evaporates.

How to handle discs

When removing a disc from its case, press down the center holder of the case and lift the disc out, holding it by the edges.

- Always hold the disc by the edges. Do not touch its recording surface.

When storing a disc into its case, gently insert the disc around the center holder (with the printed surface facing up).

- Make sure to store discs into the cases after use.

Center holder



To keep discs clean

A dirty disc may not play correctly. If a disc does become dirty, wipe it with a soft cloth in a straight line from center to edge.

- Do not use any solvent (for example, conventional record cleaner, spray, thinner, benzine, etc.) to clean discs.



To play new discs

New discs may have some rough spots around the inner and outer edges. If such a disc is used, this unit may reject the disc.

To remove these rough spots, rub the edges with a pencil or ball-point pen, etc.



Do not use the following discs:

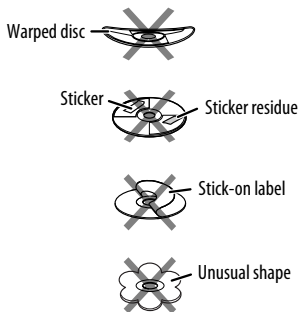

More about this unit

General

Turning on the power

- By pressing SRC on the unit, you can also turn on the power. If the source is ready, playback starts.

Turning off the power

- If you turn off the power while listening to a disc, disc play will start automatically, next time you turn on the power.

FM/AM

Storing stations in memory

- During SSM search...
 - Received stations are preset in No. 1 (lowest frequency) to No. 6 (highest frequency).
 - When SSM is over, the station stored in No. 1 will be automatically tuned in.
- When storing stations, the previously preset stations are erased and stations are stored newly.

Disc

General

- In this manual, words “track” and “file” are interchangeably used when referring to DivX/MPEG Video/MP3/WMA/WAV files and their file names.
- This unit can also play back 8 cm discs.
- This unit can only play back audio CD (CD-DA) files if different type of files are recorded in the same disc.

Inserting a disc

- When a disc is inserted upside down, “PLEASE” and “EJECT” appear alternately on the display. Press ▲ to eject the disc.

Ejecting a disc

- If the ejected disc is not removed within 15 seconds, the disc is automatically inserted again into the loading slot to protect it from dust. Playback starts automatically.

- After ejecting a disc, “NO DISC” appears and you cannot operate some of the buttons. Insert another disc or press SRC to select another playback source.

Playing Recordable/Rewritable discs

- This unit can recognize a total of 5 000 files and 250 folders (a maximum of 999 files per folder).
- This unit can recognize a total 25 characters for file/folder names.
- Use only “finalized” discs.
- This unit can play back multi-session discs; however, unclosed sessions will be skipped while playing.
- This unit may be unable to play back some discs or files due to their characteristics or recording conditions.
- Rewritable discs may require a longer readout time.

Playing MP3/WMA/WAV files

- The maximum number of characters for folder and file names is 25 characters; 128 characters for MP3/WMA/WAV tag information.
- This unit can play back files with the extension code <.mp3>, <.wma>, or <.wav> (regardless of the letter case—upper/lower).
- This unit can show the names of albums, artists (performer), and Tag (Version 1.0, 1.1, 2.2, 2.3, or 2.4) for the MP3/WMA/WAV files.
- This unit can display only one-byte characters. No other characters can be correctly displayed.
- This unit can play back files recorded in VBR (variable bit rate). Files recorded in VBR have a discrepancy in elapsed time indication.
- This unit cannot play back the following files:
 - MP3 files encoded with MP3i and MP3 PRO format.
 - MP3 files encoded with Layer 1/2.
 - WMA files encoded with lossless, professional, and voice format.
 - WMA files which are not based upon Windows Media® Audio.

- WMA files copy-protected with DRM.
- Files which have the data such as ATRAC3, etc.
- AAC files and OGG files.

Playing DivX files

- This unit can play back DivX files with the extension code <.divx>, <.div>, <.avi> (regardless of the letter case—upper/lower).
- This unit supports DivX 6.x, 5.x, 4.x, and 3.11.
- This unit supports DivX Media Format files, <.divx> or <.avi>.
- This unit can display a unique registration code—DivX Video-on-Demand (VOD—a kind of Digital Rights Management). For activation and more details, visit <www.divx.com/vod>.
- Audio stream should conform to MP3 or Dolby Digital.
- This unit does not support GMC (Global Motion Compression).
- The file encoded in the interlaced scanning mode may not be played back correctly.
- Index Search:

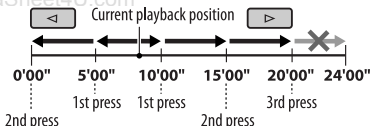

- This unit cannot play back the following files:
 - Files encoded in Codec (Compressor-decompressor) other than DivX Codec.
- If you want to know more about DivX, visit <<http://www.divx.com>>.

Playing MPEG Video files

- This unit can play back MPEG Video files with the extension code <.mpg> or <.mpeg>.
- Audio stream should conform to MPEG1 Audio Layer 2.
- This unit cannot playback the following files:
 - WMV (Windows Media Video) files
 - RM (Real Media) format files

Changing the source

- If you change the source, playback also stops (without ejecting the disc). Next time you select "DISC" for the playback source, disc play starts from where it has been stopped previously.

iPod or D. player

- When you turn on this unit, the iPod or D. player is charged through this unit.
- While the iPod or D. player is connected, all operations from the iPod or D. player are disabled. Perform all operations from this unit.
- The text information may not be displayed correctly.
- If the text information includes more than 8 characters, it scrolls on the display. This unit can display up to 40 characters.

Notice:

When operating an iPod or a D. player, some operations may not be performed correctly or as intended. In this case, visit the following JVC web site:

For iPod users: <<http://www.jvc.co.jp/english/car/support/ks-pd100/index.html>>

For D. player users: <<http://www.jvc.co.jp/english/car/support/ks-pd500/index.html>>

Title assignment

- If you try to assign titles to more than 30 station frequencies, "NAMEFULL" appears. Delete unwanted titles before assignment.

General settings—PSM

- If you change the "AMP GAIN" setting from "HIGH PWR" to "LOW PWR" while the volume level is set higher than "VOL 30," the unit automatically changes the volume level to "VOL 30."

Disc setup menu

- When the language you have selected is not recorded on a disc, the original language is automatically used as the initial language. In addition, for some discs, the initial languages settings will not work as you set due to their internal disc programming.
- When you select "16:9" for a picture whose aspect ratio is 4:3, the picture slightly changes due to the process for converting the picture width.
- Even if "4:3 PAN SCAN" is selected, the screen size may become "4:3 LETTER BOX" for some discs.

About sounds reproduced through the rear terminals

- **Through the analog terminals (Speaker out/LINE OUT):** 2-channel signal is emitted. When playing a multi-channel encoded disc, multi-channel signals are downmixed. DTS sound cannot be reproduced. (AUDIO—DOWN MIX: see page 26.)
- **Through DIGITAL OUT (optical):**
Digital signals (Linear PCM, Dolby Digital, DTS, MPEG Audio) are emitted through this terminal. (For more details, see table below.)

To reproduce multi-channel sounds such as Dolby Digital, DTS, and MPEG Audio, connect an amplifier or a decoder compatible with these multi-channel sources to this terminal, and set "DIGITAL AUDIO OUTPUT" correctly. (See page 26.)

Output signals through the DIGITAL OUT terminal

Output signals are different depending on the "DIGITAL AUDIO OUTPUT" setting on the setup menu (see page 26).

Playback Disc	Output Signal			
	STREAM/PCM	DOLBY DIGITAL/ PCM	PCM ONLY	OFF
DVD-Video	48 kHz, 16/20/24 bits Linear PCM	48 kHz, 16 bits stereo Linear PCM *		OFF
	96 kHz, Linear PCM	48 kHz, 16 bits stereo Linear PCM		
	Dolby Digital	Dolby Digital bitstream	48 kHz, 16 bits stereo Linear PCM	
	DTS	DTS bitstream		
	MPEG Audio	MPEG bitstream	48 kHz, 16 bits stereo Linear PCM	
Audio CD, Video CD	44.1 kHz, 16 bits stereo Linear PCM / 48 kHz, 16 bits stereo Linear PCM			
Audio CD with DTS	DTS bitstream			
DivX	Dolby Digital	Dolby Digital bitstream	48 kHz, 16 bits stereo Linear PCM	
	MPEG Audio	32/44.1/48 kHz, 16 bits Linear PCM		
MPEG	44.1/48 kHz, 16 bits Linear PCM			
MP3/WMA	32/44.1/48 kHz, 16 bits Linear PCM			
WAV	44.1 kHz, 16 bits stereo Linear PCM			

* Digital signals may be emitted at 20 or 24 bits (at their original bit rate) through the DIGITAL OUT terminal if the discs are not copy-protected.

On-screen guide icons

During playback, the following guide icons may appear for a while on the monitor.

▶ : Playback

⏸ : Pause

⏪ : DVD-Video/VCD: Forward slow motion

⏩ : DVD-Video: Reverse slow motion

⏭ : Forward search

⏮ : Reverse search

DVD: The following icons appear at the beginning of a scene containing:

🗣 : Multi-subtitle languages

🔊 : Multi-audio languages

🎥 : Multi-angle views

Concept diagram of the external device connection

- For connection, see Installation/Connection manual (separate volume).

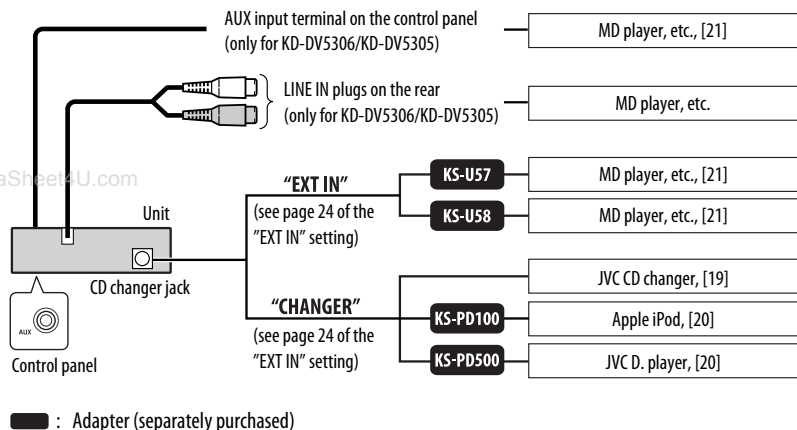

- Manufactured under license from Dolby Laboratories. Dolby and the double-D symbol are trademarks of Dolby Laboratories.
- "DTS" and "DTS Digital Out" are registered trademarks of DTS, Inc.
- "DVD Logo" is a trademark of DVD Format/Logo Licensing Corporation registered in the US, Japan and other countries.
- DivX, DivX Ultra Certified, and associated logos are trademarks of DivX, inc. and are used under license.
- Official DivX® Ultra Certified product
- Plays all versions of DivX® video (including DivX® 6) with enhanced playback of DivX® media files and the DivX® Media Format
- Microsoft and Windows Media are either registered trademarks or trademarks of Microsoft Corporation in the United States and/or other countries.
- iPod is a trademark of Apple Computer, Inc., registered in the U.S. and other countries.

Language codes

Code	Language	Code	Language	Code	Language	Code	Language	Code	Language
AA	Afar	FA	Persian	KL	Greenlandic	OC	Occitan	ST	Sesotho
AB	Abkhazian	FI	Finnish	KM	Cambodian	OM	(Afan) Oromo	SU	Sundanese
AF	Afrikaans	FJ	Fiji	KN	Kannada	OR	Oriya	SW	Swahili
AM	Ameharic	FO	Faroese	KO	Korean (KOR)	PA	Panjabi	TA	Tamil
AR	Arabic	FY	Frisian	KS	Kashmiri	PL	Polish	TE	Telugu
AS	Assamese	GA	Irish	KU	Kurdish	PS	Pashto, Pushto	TG	Tajik
AY	Aymara	GD	Scots Gaelic	KY	Kirghiz	PT	Portuguese	TH	Thai
AZ	Azerbaijani	GL	Galician	LA	Latin	QU	Quechua	TI	Tigrinya
BA	Bashkir	GN	Guarani	LN	Lingala	RM	Rhaeto-Romance	TK	Turkmen
BE	Byelorussian	GU	Gujarati	LO	Laothian	RN	Kirundi	TL	Tagalog
BG	Bulgarian	HA	Hausa	LT	Lithuanian	RO	Rumanian	TN	Setswana
BH	Bihari	HI	Hindi	LV	Latvian, Lettish	RW	Kinyarwanda	TO	Tonga
BI	Bislama	HR	Croatian	MG	Malagasy	SA	Sanskrit	TR	Turkish
BN	Bengali, Bangla	HU	Hungarian	MI	Maori	SD	Sindhi	TS	Tsonga
BO	Tibetan	HY	Armenian	MK	Macedonian	SG	Sangho	TT	Tatar
BR	Breton	IA	Interlingua	ML	Malayalam	SH	Serbo-Croatian	TW	Twi
CA	Catalan	IE	Interlingue	MN	Mongolian	SI	Singhalese	UK	Ukrainian
CO	Corsican	IK	Inupiak	MO	Moldavian	SK	Slovak	UR	Urdu
CS	Czech	IN	Indonesian	MR	Marathi	SL	Slovenian	UZ	Uzbek
CY	Welsh	IS	Icelandic	MS	Malay (MAY)	SM	Samoan	VI	Vietnamese
DZ	Bhutani	IW	Hebrew	MT	Maltese	SN	Shona	VO	Volapuk
EL	Greek	JI	Yiddish	MY	Burmese	SO	Somali	WO	Wolof
EO	Esperanto	JW	Javanese	NA	Nauru	SQ	Albanian	XH	Xhosa
ET	Estonian	KA	Georgian	NE	Nepali	SR	Serbian	YO	Yoruba
EU	Basque	KK	Kazakh	NO	Norwegian	SS	Siswati	ZU	Zulu

Troubleshooting

What appears to be trouble is not always serious. Check the following points before calling a service center.

	Symptom	Remedy/Cause
General	• Sound cannot be heard from the speakers.	• Adjust the volume to the optimum level. • Check the cords and connections.
	• The unit does not work at all.	Reset the unit (see page 2).
FM/AM	• SSM automatic presetting does not work.	Store stations manually.
	• Static noise while listening to the radio.	Connect the antenna firmly.
Discs in general	• Disc cannot be played back.	Insert the disc correctly.
	• Disc can be neither played back nor ejected.	• Unlock the disc (see page 11). • Eject the disc forcibly (see page 2).
	• Recordable/Rewritable discs cannot be played back.	• Insert a finalized disc.
	• Tracks on the Recordable/Rewritable discs cannot be skipped.	• Finalize the discs with the component which you have used for recording.
	• Disc cannot be recognized.	Eject the disc forcibly (see page 2).
	• Sound and pictures are sometimes interrupted or distorted.	• Stop playback while driving on rough roads. • Change the disc. • Check the cords and connections.
	• No playback picture (DVD-Video/DivX/MPEG/VCD) appears on the monitor.	Parking brake wire is not connected properly. (See Installation/Connection Manual.)
	• No picture appears on the monitor at all.	• Connect the video cord correctly. • Select a correct input on the monitor.
	• The monitor shows black and white wavy pictures (DVD-Video/DivX/MPEG/VCD).	Select an appropriate video format (PAL/NTSC) for your monitor (see page 24).
	• The left and right edges of the picture are missing on the monitor.	Select "4:3 LETTER BOX" (see page 26).
DivX/MPEG Video/MP3/WMA/WAV	• Disc cannot be played back.	• Change the disc. • Record the tracks using a compliant application in the appropriate discs (see page 4). • Add the extension code <.divx>, <.div>, <.avi>, <.mpg>, <.mpeg>, <.mp3>, <.wma>, or <.wav> to the file names.
	• Noise is generated.	Skip to another track or change the disc.

	Symptom	Remedy/Cause
DivX/MPEG Video/MP3/WMA/WAV	• Longer readout time is required.	Readout time varies due to the complexity of the folder/file configuration. Do not use too many hierarchies and folders.
	• Tracks cannot play back as you have intended them to play.	Playback order is determined when files are recorded.
	• No sound can be heard when picture is displayed while playing a DivX/MPEG Video file.	<ul style="list-style-type: none"> Record the audio track using MP3 or Dolby Digital as the audio stream of DivX files. Record the audio track using MPEG1 Audio Layer 2 as the audio stream for MPEG Video files.
	• Elapsed playing time is not correct.	This sometimes occurs during playback. This is caused by how the tracks are recorded.
	• "PLEASE" and "EJECT" appear alternately on the display.	Insert a disc that contains tracks of appropriate formats.
	• Correct characters are not displayed (e.g. album name).	This unit can only display letters (upper case), numbers, and a limited number of symbols.
CD changer	• "NO DISC" appears on the display.	Insert a disc into the magazine.
	• "NO MAG" appears on the display.	Insert the magazine.
	• "RESET 8" appears on the display.	Connect this unit and the CD changer correctly and press the reset button of the CD changer.
	• "RESET 1" – "RESET 7" appears on the display.	Press the reset button of the CD changer.
	• The CD changer does not work at all.	Reset the unit (see page 2).
iPod/D. player	• The iPod or D. player does not turn on or does not work.	<ul style="list-style-type: none"> Check the connecting cable and its connection. Charge the battery. Update the firmware version.
	• The sound is distorted.	Deactivate the equalizer either on this unit or the iPod/D. player.
	• "NO IPOD" or "NO DP" appears on the display.	<ul style="list-style-type: none"> Check the connecting cable and its connection. Charge the battery.
	• Playback stops.	The headphones are disconnected during playback. Restart the playback operation (see page 20).
	• No sound can be heard when connecting an iPod nano.	<ul style="list-style-type: none"> Disconnect the headphones from the iPod nano. Update the firmware version of the iPod nano.
	• No sound can be heard. • "ERROR 01" appears on the display when connecting a D. player.	Disconnect the adapter from the D. player. Then, connect it again.

	Symptom	Remedy/Cause
iPod/D. player	• "NO FILES" or "NO TRACK" appears on the display.	No tracks are stored. Import tracks to the iPod or D. player.
	• "RESET 1" – "RESET 7" appears on the display.	Disconnect the adapter from both this unit and iPod/D. player. Then, connect it again.
	• "RESET 8" appears on the display.	Check the connection between the adapter and this unit.
	• The iPod's or D. player's controls do not work after disconnecting from this unit.	Reset the iPod or D. player.

Specifications

AUDIO AMPLIFIER SECTION	Maximum Power Output:	Front/Rear:	50 W per channel
	Continuous Power Output (RMS):	Front/Rear:	19 W per channel into 4 Ω , 40 Hz to 20 000 Hz at no more than 0.8% total harmonic distortion
	Load Impedance:		4 Ω (4 Ω to 8 Ω allowance)
	Tone Control Range:	Bass:	± 12 dB at 100 Hz
		Treble:	± 12 dB at 10 kHz
	Signal to Noise Ratio:		70 dB
	Audio Output Level:	Digital (DIGITAL OUT: Optical):	Signal wave length: 660 nm
			Output level: -21 dBm to -15 dBm
		Line-Out Level/Impedance:	2.5 V/20 k Ω load (full scale)
		Output Impedance:	1 k Ω
	Color system:		PAL/NTSC
	Video Output (composite):		1 Vp-p/75 Ω
Other Terminal:	KD-DV5306/KD-DV5305: CD changer, LINE IN, AUX (auxiliary) input jack KD-DV4306/KD-DV4305: CD changer		

TUNER SECTION	Frequency Range:	FM:	87.5 MHz to 108.0 MHz
		AM:	531 kHz to 1 602 kHz
	FM Tuner:	Usable Sensitivity:	11.3 dBf (1.0 μ V/75 Ω)
		50 dB Quieting Sensitivity:	16.3 dBf (1.8 μ V/75 Ω)
		Alternate Channel Selectivity (400 kHz):	65 dB
		Frequency Response:	40 Hz to 15 000 Hz
	Stereo Separation:	30 dB	
AM Tuner:	Sensitivity/Selectivity:	20 μ V/35 dB	

DVD/CD PLAYER SECTION	Signal Detection System:	Non-contact optical pickup (semiconductor laser)		
	Number of Channels:	2 channels (stereo)		
	Frequency Response:	DVD, fs=48 kHz/96 kHz:	16 Hz to 22 000 Hz	
		CD, fs=44.1 kHz:	16 Hz to 20 000 Hz	
	Dynamic Range:	96 dB		
	Signal-to-Noise Ratio:	98 dB		
	Wow and Flutter:	Less than measurable limit		
	DivX/MPEG Video:	Video:	Max. Resolution:	720 \times 480 pixels (30 fps) 720 \times 576 pixels (25 fps)
			Audio:	Bit Rate:
		Sampling Frequency: DivX:		MPEG-1: 32 kHz, 44.1 kHz, 48 kHz MPEG-2: 16 kHz, 22.05 kHz, 24 kHz
		Sampling Frequency: MPEG Video:	32 kHz, 44.1 kHz, 48 kHz	
	MP3:	Bit Rate:	32 kbps – 320 kbps	
		Sampling Frequency:	MPEG-1: 32 kHz, 44.1 kHz, 48 kHz MPEG-2: 16 kHz, 22.05 kHz, 24 kHz	
WMA:	Bit Rate:	32 kbps – 320 kbps		
	Sampling Frequency:	22.05 kHz, 32 kHz, 44.1 kHz, 48 kHz		
WAV:	Quantization Bit Rate:	16 bit		
	Sampling Frequency:	44.1 kHz		

GENERAL	Power Requirement:	Operating Voltage:	DC 14.4 V (11 V to 16 V allowance)	
	Grounding System:	Negative ground		
	Allowable Operating Temperature:	0°C to +40°C		
	Dimensions (W \times H \times D):	Installation Size (approx.):	182 mm \times 52 mm \times 158 mm	
		Panel Size (approx.):	187 mm \times 58 mm \times 13 mm	
	Mass (approx.):	1.6 kg (excluding accessories)		

Design and specifications are subject to change without notice.

www.DataSheet4U.com

多謝您惠購 JVC 的產品。
 在使用之前，請詳讀全部說明書，以確保完全理解本機使用方法，
 並獲得較長的使用壽命。

鐳射產品的重要說明

1. 一級鐳射產品
2. 注意：請勿打開頂蓋板，本機內部沒有用戶可自行維修的部件；所有維修工作應由有資格的人員完成。
3. 注意：打開蓋板可能會產生可見或不可見的 1M 級鐳射。不要使用光學儀器直接進行窺視。
4. 標籤的複製標示：注意標籤位於機外。

CAUTION VISIBLE AND/OR INVISIBLE CLASS 1M LASER RADIATION WHEN OPEN, DO NOT VIEW DIRECTLY WITH OPTICAL INSTRUMENTS IEC60825-1:2001 (ENG)	ATTENTION RAYONNEMENT LASER VISIBLE ET/OU INVISIBLE DE CLASSE 1M UNE FOIS OUVERT, NE PAS REGARDER DIRECTEMENT AVEC DES INSTRUMENTS OPTIQUES. (FRA)	AVISO RADIACION LASER DE CLASE 1M VISIBLE Y/O INVISIBLE CUANDO ESTA ABIERTO, NO MIRAR DIRECTAMENTE CON INSTRUMENTAL OPTICO. (SPA)	VARNING SYNLIK OCH/ELLER OSYNLIG LASERSTRÅLNING, KLASSE 1M, NÄR DENNA DEL ÄR ÖPPNAD. BETRÄKTA EJ STRÅLEN MED OPTISKA INSTRUMENT. (SWE)	注意 ここを開くと可視 及び/または不可視 のクラス 1M レーザー放射が 発生します。 光学器械で直視 しないでください。 (JPN)	CAUTION VISIBLE AND/OR INVISIBLE CLASS II LASER RADIATION WHEN OPEN, DO NOT STARE INTO BEAM. FDA 21 CFR (ENG)
-------------------------------------------------------------------------------------------------------------------------------------------------------------------------	-----------------------------------------------------------------------------------------------------------------------------------------------------------------------------------	------------------------------------------------------------------------------------------------------------------------------------------------------------------	-----------------------------------------------------------------------------------------------------------------------------------------------------------------------	-----------------------------------------------------------------------------------------------------	----------------------------------------------------------------------------------------------------------------------------------------------



[僅對應歐洲聯盟]

www.DataSheet4U.com

本產品的防止拷貝技術受美國專利和其他知識
 產權保護法的保護。任何使用本技術的行為必
 須經過 Macrovision 批准，未經 Macrovision 特
 別批准時，不可用於家用或其他私用之外的目
 的。使用本機時不可進行違規操作或分解。

如何重設本機

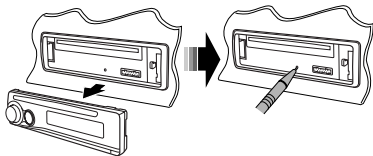

- 您所做的預設調整亦會被清除。

如何強制彈出碟片

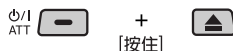

- 在彈出碟片時，小心不要將碟片掉落。
- 如果以上操作無效，請嘗試重設本機。

如何使用功能模式

若按 M MODE 鍵，本機將進入功能模式，此時
 數字鍵和 ▲/▼ 鍵將發揮不同功能鍵的作用。

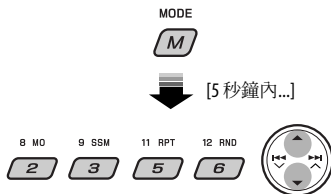

警告：
防止交通事故和損壞

- 切勿將本機安裝在下述位置：
 - 可能會妨礙操作方向盤和變速排檔桿的位置。
 - 可能會妨礙操作安全裝置，如安全氣袋等的位置。
 - 可能會妨礙視野的位置。
- 切勿在駕駛過程中操作本機。
- 在駕駛過程中若需要操作本機，切記要密切注意前方。
- 駕駛員在駕駛過程中切勿觀看顯示器。
若手剎車未適合，“駕駛時，駕駛員請勿觀看顯示屏。”字樣在顯示器上出現，且無法播放圖像。
 - 僅當手剎車導線與汽車內置的手剎車系統相連接時此警告信息才會出現（參閱安裝 / 連接手冊）。

www.DataSheet4U.com

音量設定須知

與其他播放源相比，碟片產生的噪音非常小。為避免輸出音量水平突然增大而損壞揚聲器，請在播放碟片之前將音量調低。

基於安全事項...

- 切勿將音量設定得太高，因為這會妨礙聽到外界的聲音，給駕駛帶來危險。
- 在進行任何複雜的操作之前請先將車停下。

關於車內溫度...

若長時間將車停在炎熱或寒冷的氣候裡，在操作主機前請等待一段時間，直到車內的溫度恢復到正常。

目錄

簡介

可播放碟片類型.....	4
著手準備.....	5

操作

基本操作	
• 控制面板.....	6
• 遙控器 (RM-RK241)	7
收聽廣播電臺.....	10
碟片的操作.....	11

外接裝置

收聽CD 換碟器.....	19
收聽iPod/D. 播放機.....	20
收聽其他外接組件.....	21

設定

選擇預設聲音模式.....	22
一般設定— PSM.....	23
碟片設定菜單.....	25
為播放源命名.....	27

參考

保養.....	28
關於本接收機的附加信息.....	29
故障排除.....	34
規格.....	36

本手冊中使用的面板圖示為 KD-DV5306/
KD-DV5305。

www.DataSheet4U.com

可播放碟片類型

碟片類型	錄製制式，文件類型等	可否播放
DVD	DVD-視頻 (區域代碼包含“3”)*1 	✓OK
	DVD-音頻	✗NO
	DVD-ROM	
可錄製 / 可反復錄製的 DVD (DVD-R*/-RW, +R/+RW*3)	DVD-視頻	✓OK
	DivX 視頻	
	MPEG-1/MPEG-2 視頻	
	MP3/WMA/WAV	
	JPEG/MPEG4	✗NO
	DVD-VR, +VR	
DVD-RAM	All	✗NO
雙碟	DVD 面	✓OK
	非 DVD 面	✗NO
CD/VCD	音頻 CD (CD-DA) / DTS-CD*4	✓OK
	VCD (視頻 CD)	
	文本 CD	
	CD-ROM	✗NO
	CD-I (CD-I 就緒)	
可錄製 / 可反復錄製的 CD (CD-R/-RW) • 與 ISO 9660 level 1, level 2, Romeo, Joliet 相兼容	CD-DA	✓OK
	DivX 視頻, VCD (視頻 CD)	
	MPEG-1/MPEG-2 視頻	
	MP3/WMA/WAV	
	JPEG/MPEG4	✗NO

*1 如果裝入了區域代碼不正確的DVD 視頻碟片，“區域代碼錯誤！”字樣在顯示器上出現。

*2 以多邊界格式錄製的DVD-R 也可以播放（雙層光碟除外）。

*3 可以播放格式化的+R/+RW（僅視頻格式）碟片。但是，不推荐使用+R 雙層碟片。

*4 想要再生DTS 聲音，使用DIGITAL OUT 端子（另參閱第26 和31 頁）。

雙碟播放之注意事項

“DualDisc（雙碟）”的非DVD 碟面與“壓縮碟片數碼音頻”標準不兼容。因此，建議您不要在本產品上播放雙碟的非DVD 碟面。

著手準備

取消屏幕演示和設定時鐘

• 參閱第 24 頁。

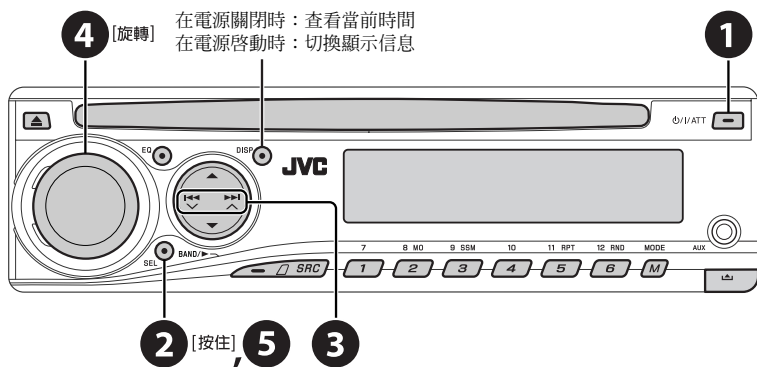

- 1 打開電源。
- 2 進入 PSM 設定。
- 3 → 4 取消屏幕演示
選擇“DEMO”，然後“DEMO OFF”。
- 設定時鐘
選擇“CLOCK H”（小時），然後調整小時。
選擇“CLOCK M”（分鐘），然後調整分鐘。
- 5 完成設定。

卸下控制面板

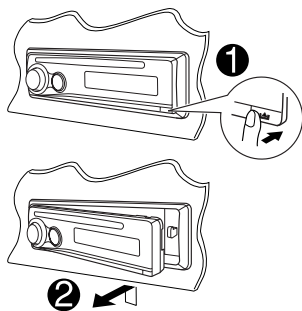

裝上控制面板

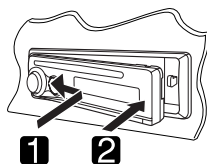

www.DataSheet4U.com

- **FM/AM**：選擇預設電臺。
- **DISC**：選擇標題 / 文件夾。
- **IPOD/D. 播放機**：進入主菜單 / 暫停或停止播放 / 確認選擇。

- 打開電源。
- 關閉電源 [按住]。
- 降低音量 (若電源已打開)。

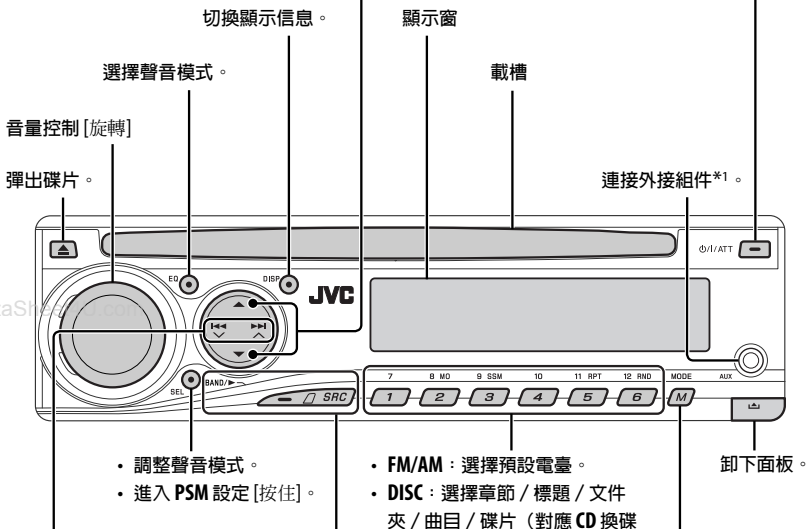

- 調整聲音模式。
- 進入 **PSM** 設定 [按住]。
- **FM/AM**：搜索電臺。
- **DISC**：選擇章節 / 曲目。
- **IPOD/D. 播放機**：選擇曲目。

- **FM/AM**：選擇預設電臺。
- **DISC**：選擇章節 / 標題 / 文件夾 / 曲目 / 碟片 (對應 **CD 換碟器**)。



- **FM/AM**：選擇波段。
- **DISC**：開始播放。



選擇播放源。

FM/AM → **DISC** *2 → **CD-CH** *2 / **IPOD** *2 / **D.PLAYER** *2 (或 **EXT IN**) → **LINE IN** *1 → **AUX IN** *1 → (返回至開始處)

- 進入功能模式。
按 **M MODE** 鍵，然後按下列按鍵之一 (5 秒鐘內) ...
- MO**：打開 / 關閉單聲道接收。
 - SSM**：自動預設電臺 [按住]。
 - RPT**：選擇重複播放。
 - RND**：選擇隨機播放。
 - ▲/▼**：跳過 10 個章節 / 10 首曲目。

*1 僅對應 **KD-DV5306/KD-DV5305**。

*2 如果播放源尚未準備好或沒有連接好，您不能選取它們。

顯示窗

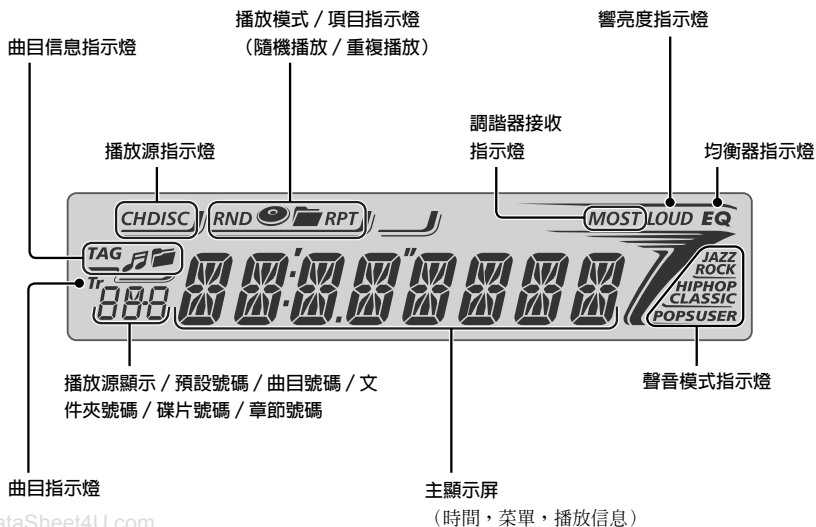

www.DataSheet4U.com

基本操作 — 遙控器 (RM-RK241)

安裝鈕扣型鋰電池 (CR2025)

在使用遙控器之前：

- 將遙控器直接對準本機上的遙感器。
- 切勿將遙感器暴露於強光照射處 (直射的陽光或人工光線)。

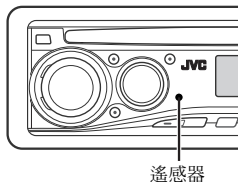
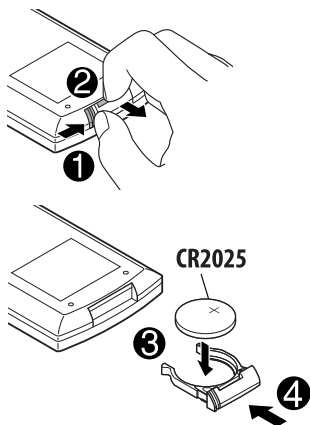

www.DataSheet4U.com

請按下列頁

警告： 防止意外事故和損壞

- 切勿使用 CR2025 或其相同類型以外的電池。
- 切勿將遙控器放置在暴露於直射陽光下的位置（如儀表盤）很長時間，否則可能引起爆炸。
- 請將電池存放在兒童無法拿到的地方。
- 切勿為電池充電、使電池短路、分解電池、加熱電池或將其扔置於火中。
- 切勿將電池與其他金屬物質放在一起。
- 切勿用鑷子或類似的工具穿刺電池。
- 要廢棄或保存電池時，請用膠帶纏繞並使其處於絕緣狀態。

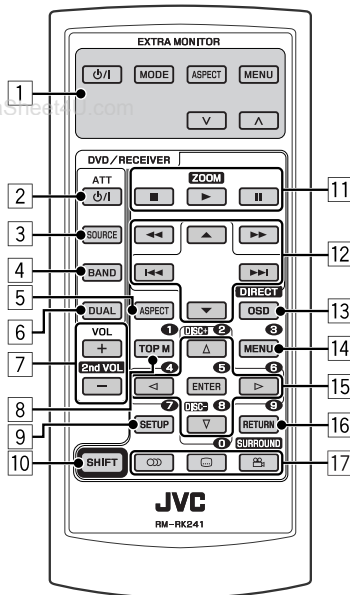

EXTRA MONITOR

- 顯示器控制鍵
 - 用於 JVC 顯示器—KV-MR9010，KV-MH6510，KV-M706 或 KV-M705。

DVD/RECEIVER

- 短促地按則啓動電源或已啓動電源時降低音量。
 - 按住不放則關閉電源。
- 選擇播放源。
- 選擇 FM/AM 波段。
- 對應本機無效。
- 對應本機無效。
- 調整音量水平。
 - 2nd VOL：對應本機無效。
- *1 DVD-視頻 / DivX：顯示碟片菜單。
 - VCD：開始 PBC 播放。
- *1 進入碟片設定菜單。
- SHIFT 鍵
- （停止），▶（播放），⏸（暫停）
 - 當與 SHIFT 鍵同時按下時，▶（播放）鍵也可作為 ZOOM 鍵使用（參閱第 15 頁）。
 - 對應 CD 換碟器 / iPod / D. 播放機操作無效。
- 對應高級碟片操作：
 - ▲ / ▼ 鍵：
 - DVD-視頻：選擇標題。
 - DivX / MPEG 視頻 / MP3 / WMA / WAV：若包含文件夾，選擇文件夾。
 - ◀◀ / ▶▶ 鍵：
 - 短促地按則倒退跳播 / 前進跳播。
 - 按住不放則倒退搜索 / 前進搜索。
 - ◀◀ / ▶▶ 鍵：倒退搜索 / 前進搜索。*2
- 對應 FM/AM 調諧器操作：
 - ▲ / ▼ 鍵：切換預設電臺。
 - ◀◀ / ▶▶ 鍵：
 - 短促地按則自動搜索電臺。
 - 按住不放則手動搜索電臺。

對應 Apple iPod/JVCD 播放機操作：

- **▼** 鍵：暫停 / 停止或重新開始播放。
- **▲** 鍵：進入主菜單。
(現在 **▲/▼/◀◀/▶▶** 鍵也可作為菜單選擇鍵使用。)*3
- **◀◀/▶▶** 鍵 (在菜單選擇模式下)：
 - 短促地按則選擇一個項目。(然後，按 **▼** 鍵確認選擇。)
 - 按住不放則可一次跳過 10 個項目。
- **◀◀/▶▶** 鍵：
 - 短促地按則倒退跳播 / 前進跳播。
 - 按住不放則倒退搜索 / 前進搜索。

13 顯示屏幕菜單欄。

- 當與 **SHIFT** 鍵同時按下時，也可作為 **DIRECT** 鍵使用。*4

14 *1 DVD-視頻 / DivX：顯示碟片菜單。

- **VCD**：開始 **PBC** 播放。

15 *1 選擇 / 設定。

- **</>**：DivX：在播放過程中搜索目錄。
- **DISC +/-** 鍵：播放源為“CD-CH”時切換碟片。

16 *1 **RETURN** 鍵

- 17** • **DVD-視頻**：選擇音頻語言 (🗣️)，字幕 (☰) *1，角度 (👁️) *5。
- **DivX**：選擇音頻語言 (🗣️)，字幕 (☰)。
- **VCD**：選擇音頻聲道 (🔊)。

*1 當與 **SHIFT** 鍵同時按下時，可作為數字鍵使用。

- **FM/AM**：選擇預設電臺。
- **DISC**：按 **SHIFT** 和 **DIRECT** 鍵進入搜索模式後，選擇章節 / 標題 / 文件夾 / 曲目。

*2 對應 CD 換碟器操作無效。

*3 **▲** 鍵：回到前面的菜單。

▼ 鍵：確認選擇。

*4 可直接使用數字鍵選擇標題 / 章節 / 文件夾 / 曲目 (參閱第 13 - 15 頁)。

*5 當與 **SHIFT** 鍵同時按下時，可作為 **SURROUND** 鍵使用 (對應本機無效)。

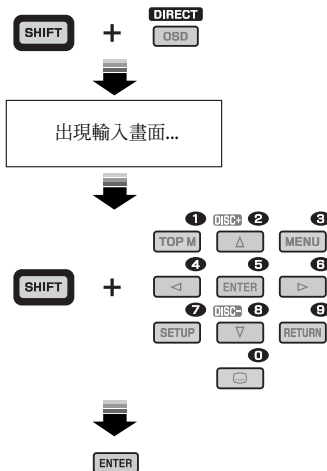
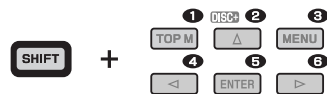
如何選擇數字**如何選擇預設電臺**

收聽廣播電臺

切換顯示信息

→ 時鐘 → 電臺名稱* → 頻率

* 如果電臺未被命名, “NO NAME” 字樣出現。若要為電臺命名, 參閱第 27 頁。

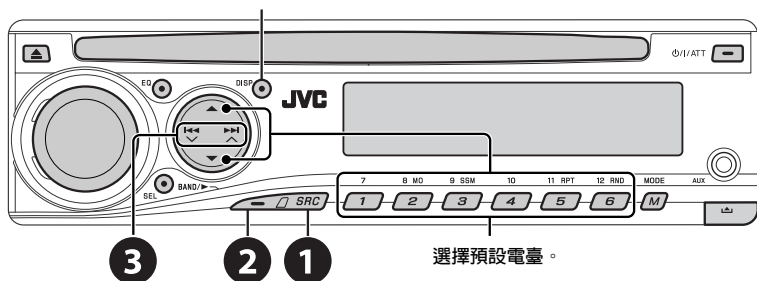

選擇預設電臺。

1 選擇 “FM/AM”。

2 選擇波段。

→ FM1 → FM2 → FM3 → AM

3 搜索想要收聽的電臺—自動搜索。

手動搜索: 按住一個鍵直到 “M” 字樣在顯示屏上閃爍, 然後反復地按該鍵。

在接收具有足夠信號強度的 FM 立體聲廣播時點亮。



當 FM 立體聲廣播接收不良時

1 MODE
M

2 8 MO
2

接收效果得以改善, 但是立體聲效果被取消。

• MO 指示燈點亮。

3 9 SSM
3 [按住]



此項操作將搜索到當地信號最強的 FM 電臺, 並自動將其儲存至 FM 波段中。

自動預設 FM 電臺—SSM (強信號電臺順次記憶)

您可在每個波段預設六個電臺。

1 BAND/PR

2 MODE
M

手動預設電臺

例: 將頻率為 92.5 MHz 的 FM 電臺儲存到 FM1 波段的預設號碼 4 中。

1 BAND/PR

2



3 10
4 [按住]





碟片的操作

在進行任何操作之前...

啟動顯示器以觀看播放畫面。如果啟動顯示器，您也可以參考顯示畫面控制其他碟片的播放。
(參閱第 15 - 18。)

碟片類型被自動檢測並開始播放 (對應 DVD：自動開始操作取決於內部程序的設定)。
如果當前碟片沒有碟片菜單，所有曲目將重複播放直到您切換播放源或彈出碟片。



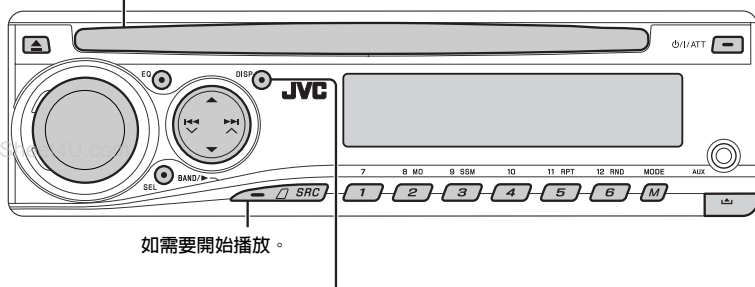

當您按下某個按鍵時，如果“”在顯示器上出現，表示碟片不能接受您試圖進行的操作。

- 在某些情況下，雖然沒有“”顯示，操作亦可能不被接受。

裝入碟片。
自動開始播放。



切換顯示信息

	已過播放時間	時鐘	當前標題和 章節號碼
	已過播放時間	時鐘	曲目標題
			文件夾名稱
	已過播放時間和 當前曲目號碼	時鐘和 當前曲目號碼	
	已過播放時間和 當前曲目號碼	時鐘和 當前曲目號碼	專輯名稱 / 表演者 (文件名稱*1)
	曲目標題		專 輯 名 稱 / 表 演 者 (文件名稱*1)
	已過播放時間和 當前曲目號碼	時鐘和 當前曲目號碼	
	曲目標題*2		碟片標題 / 表演者*2

禁止碟片彈出

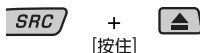









想要取消碟片鎖定时，重複相同步驟即可。

*1 若文件沒有標籤信息或“TAG DISP”設定為“TAG OFF” (參閱第24頁)，文件夾名稱和文件名稱會出現。TAG 指示燈將不會點亮。

*2 對應音頻CD，“NO NAME”字樣出現。

使用控制面板操作

按（或按住）下面的鍵可讓您進行以下操作...

碟片類型			 (數字鍵)*3
DVD Video 	按：選擇章節 按住：倒退 / 快進章節*1	選擇標題	在停止狀態下：搜索標題 在播放過程中或暫停狀態下：搜索章節
DivX/MPEG 	按：選擇曲目 按住：倒退 / 快進曲目*2	選擇文件夾	直接搜索特定文件夾
VCD 	按：選擇曲目 按住：倒退 / 快進曲目*1	—	直接搜索特定曲目（在未使用 PBC 功能狀態下）
MP3/WMA/WAV 	按：選擇曲目 按住：倒退 / 快進曲目*1	選擇文件夾	直接搜索特定文件夾
CD 	按：選擇曲目 按住：倒退 / 快進曲目*1	—	直接搜索特定曲目









*1 顯示器上的搜索速度切換為 $\times 2 \Leftrightarrow \times 10$ 。

*2 顯示器上的搜索速度切換為 $\blacktriangleright 1 \Leftrightarrow \blacktriangleright 2$ 。

*3 按則選擇號碼 1 至 6；按住則選擇號碼 7 至 12。

MODE

按  鍵後，按下列按鍵進行以下操作...

碟片類型		 11 RPT 5	 12 RND 6
DVD Video 	跳播 10 個章節（在播放過程中或暫停狀態下）	CHP RPT ：重複播放當前章節 TIT RPT ：重複播放當前標題	—
DivX/MPEG 	跳播 10 首曲目（同一個文件夾內）	TRK RPT ：重複播放當前曲目 FLDR RPT ：重複播放當前文件夾	—
VCD 	跳播 10 首曲目（在未使用 PBC 功能狀態下）	TRK RPT ：重複播放當前曲目（在未使用 PBC 功能狀態下）	DISC RND ：隨機播放所有曲目（在未使用 PBC 功能狀態下）
MP3/WMA/WAV 	跳播 10 首曲目（同一個文件夾內）	TRK RPT ：重複播放當前曲目 FLDR RPT ：重複播放當前文件夾	FLDR RND ：隨機播放當前文件夾的所有曲目，然後下一文件夾的曲目 DISC RND ：隨機播放所有曲目
CD 	跳播 10 首曲目	TRK RPT ：重複播放當前曲目	DISC RND ：隨機播放所有曲目

• 想要取消重複播放模式或隨機播放模式時，選擇“RPT OFF”或“RND OFF”。

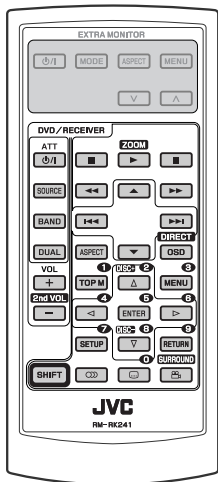

- : 停止播放
- : 暫停 (在暫停狀態下按該鍵, 逐幀播放。)
- : 開始播放
- : 倒退 / 前進搜索章節*1
 - 在暫停狀態下慢動作播放*2。無聲音傳出。
- : 按: 選擇章節 (在播放過程中或暫停狀態下)
按住: 倒退 / 快進搜索章節*3
- : 選擇標題
- : 選擇音頻語言
- : 選擇字幕語言
- : 選擇觀賞角度



如何直接搜索章節 / 標題

- 1 選擇章節 / 標題搜索。

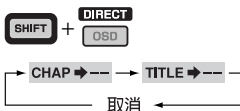

- 2 輸入所需號碼。

SHIFT + 0 ... 9

- 3 ENTER

使用菜單驅動功能...

- 1 TOP M / MENU

- 2 選擇想要開始播放的項目。



- 3 ENTER

*1,2,3,4,5: 參閱第 14 頁。

- : 停止播放
- : 暫停 (在暫停狀態下按該鍵, 逐幀播放。)
- : 開始播放
- : 倒退 / 前進搜索曲目*4
- : 按: 選擇曲目
按住: 倒退 / 快進搜索曲目*5
- : 選擇文件夾
- : • 畫面倒退 / 快進大約 5 分鐘 (目錄搜索)。
• 選擇章節。
- : DivX: 選擇字幕語言
- : DivX: 選擇音頻語言



如何直接搜索曲目 (在同一個文件夾內) / 文件夾

- 1 選擇曲目 / 文件夾搜索。

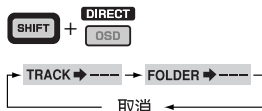

- 2 輸入所需號碼。

SHIFT + 0 ... 9

- 3 ENTER



- : 停止播放
- : 暫停 (在暫停狀態下按該鍵，逐幀播放。)
- : 開始播放
- : 倒退 / 前進搜索曲目*1
 - 在暫停狀態下前進慢動作播放*2。無聲音傳出。(倒退慢動作無效。)
- : 按: 選擇曲目
按住: 倒退 / 快進搜索曲目*3
- : 選擇音頻聲道
(ST: 立體聲, L: 左聲道, R: 右聲道)

取消 PBC 播放...

- 1
 - 2 + +
 - 3 輸入想要的號碼。
 + ...
 - 4
- 想要恢復 PBC 功能，按 / 鍵。

- : 停止播放
- : 暫停
- : 開始播放
- : 倒退 / 前進搜索曲目*1
- : 按: 選擇曲目
按住: 倒退 / 快進搜索曲目*3
- : 選擇文件夾

如何直接搜索曲目 (在同一個文件夾內) / 文件夾



- 1 選擇曲目 / 文件夾搜索。

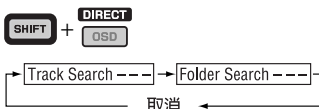

- 2 輸入所需號碼。
 + ...
- 3

- : 停止播放
- : 暫停
- : 開始播放
- : 倒退 / 前進搜索曲目*1
- : 按: 選擇曲目
按住: 倒退 / 快進搜索曲目*3

如何直接搜索曲目



- 1 選擇曲目搜索。

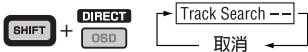

- 2 輸入所需號碼。
 + ...
- 3

*1 若反復地按，顯示器上的搜索速度切換為×2 ⇨ ×5 ⇨ ×10 ⇨ ×20 ⇨ ×60。

*2 若反復地按，顯示器上的慢動作播放速度切換為▶1/32 ⇨ ▶1/16 ⇨ ▶1/8 ⇨ ▶1/4 ⇨ ▶1/2。

*3 顯示器上的搜索速度切換為×2 ⇨ ×10。

*4 若反復地按，顯示器上的搜索速度切換為▶▶1 ⇨ ▶▶2 ⇨ ▶▶3。

*5 顯示器上的搜索速度切換為▶▶1 ⇨ ▶▶2。

放大觀賞畫面—放大 (DVD / DivX / MPEG 視頻 / VCD)

在播放畫面移動過程中...

- 1 按住 **SHIFT** 鍵的同時，反復按 **ZOOM** 鍵。



- 2 移動被放大的部位。



- 想要取消放大，選擇“ZOOM OFF”。

使用屏幕菜單欄操作 (DVD / DivX / MPEG 視頻 / VCD)

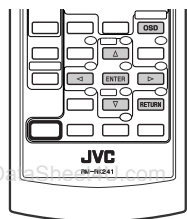

這些操作可使用遙控器在顯示器上進行。

- 1 顯示屏幕菜單欄 (參閱第 16 頁)。

OSD (兩次)

- 2 選擇一個項目。



- 3 進行選擇。

ENTER

若出現下拉菜單...



- 想要取消下拉菜單，按 **RETURN** 鍵。
- 想要輸入時間 / 號碼，參閱以下內容。

- 4 取消屏幕菜單欄。

OSD

輸入時間 / 號碼

按 **▲** **▼** 鍵切換號碼，然後按 **◀** **▶** 鍵移至下一層輸入。

- 每次您按 **▲** **▼** 鍵，號碼遞增 / 遞減一個數值。
- 輸入號碼後，按 **ENTER** 鍵。
- 無須輸入零和尾端零 (下例中的最後兩位數)。

例：時間搜索

DVD: _:__:__ (例：1:02:00)

按 **▲** 鍵一次，然後按 **▶** 鍵兩次進入第三層輸入，按 **▲** 鍵兩次，然後按 **ENTER** 鍵。

螢幕菜單欄

例：DVD-視頻

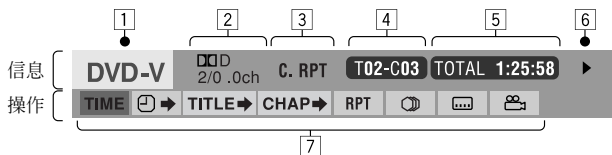

1 碟片類型

2 • DVD-視頻 / DTS-CD：音頻信號格式類型及頻道

• VCD：PBC

3 播放模式*1

DVD-視頻：**T. RPT**：重複播放標題

C. RPT：重複播放章節

DivX / MPEG 視頻：**T. RPT**：重複播放曲目

F. RPT：重複播放文件夾

VCD*2：**T. RPT**：重複播放曲目

D. RND：隨機播放碟片

T. INT：簡介播放曲目*3

4 播放信息

T02-C03 當前標題 / 章節

TRACK 01 當前曲目

F001-T001 當前文件夾 / 曲目

5 時間指示燈

TOTAL 碟片的已過播放時間（對應 DVD 視頻，為當前標題的已過播放時間。）

T. REM DVD-視頻：剩餘標題時間

VCD：剩餘碟片時間

TIME 當前章節 / 曲目的已過播放時間

REM 當前章節 / 曲目的剩餘播放時間

6 播放狀態

▶ 播放

▶▶ / ◀◀ 前進 / 倒退搜索

||▶ / ◀|| 慢動作前進 / 倒退

|| 暫停

■ 停止

7 操作圖標

TIME 切換時間指示信息（參閱 5）

☞ 時間搜索（輸入當前標題或碟片的已過播放時間。）

TITLE▶ 標題搜索（通過號碼）

CHAP▶ 章節搜索（通過號碼）

TRACK▶ 曲目搜索（通過號碼）

🔊 切換音頻語言或音頻聲道

🗣️ 切換字幕語言

🖼️ 切換觀賞角度

RPT 重複播放*1

INT 簡介播放*3

RND 隨機播放*1

*1 有關重複播放 / 隨機播放的信息，參閱第 12 頁。

*2 在未使用 PBC 功能狀態下。

*3 播放開始 15 秒的...

TRACK INTRO：當前碟片的所有曲目。

FOLDER INTRO：當前碟片所有文件夾的第一個曲目。

使用控制畫面操作 (DivX / MPEG 視頻 / MP3 / WMA / WAV / CD)

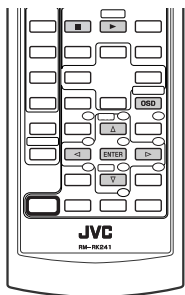

這些操作可以使用遙控器在顯示器上進行。

- 1 顯示控制畫面。
DivX / MPEG 視頻：在播放過程中按 鍵。
MP3/WMA/WAV/CD：在播放過程中自動出現。
- 2 選擇“Folder”欄或“Track”欄 (CD 除外)。
- 3 選擇一個文件夾或曲目。
- 4 開始播放。
DivX / MPEG 視頻：按 / 鍵。
MP3/WMA/WAV/CD：自動開始播放。

控制畫面

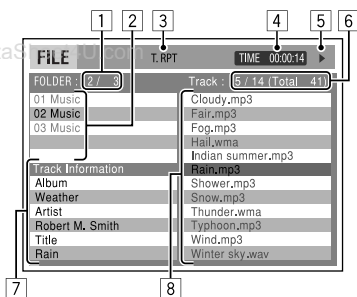

例：MP3/WMA/WAV 碟片

- 1 當前文件夾號碼 / 總文件夾數量
- 2 當前所選文件夾的文件夾清單
- 3 所選播放模式
- 4 當前曲目的已過播放時間
- 5 操作模式圖標 (▶, ■, ||, ▶▶, ◀◀)
- 6 當前文件夾的當前曲目號碼 / 總曲目數量 (碟片的總曲目數量)
- 7 曲目信息
- 8 當前所選曲目的曲目清單

如何選擇一種播放模式

- 1 當顯示控制畫面時...



播放模式選擇畫面出現在控制畫面的文件夾清單部分。

- 2 選擇一種播放模式。



- 3 選擇一個項目。

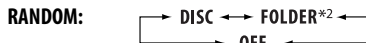

- 4 確認選擇。



*1 對應 DivX / MPEG 視頻時不可選擇
*2 對應 CD 時不可選擇

模式	播放功能
F. RPT (重複播放文件夾) :	重複播放當前文件夾
T. RPT (重複播放曲目) :	重複播放當前曲目
F. INT (簡介播放文件夾) :	播放當前碟片的所有文件夾第一個曲目前 15 秒鐘
T. INT (簡介播放曲目) :	播放當前碟片的所有曲目前 15 秒鐘
D. RND (隨機播放碟片) :	隨機播放所有曲目
F. RND (隨機播放文件夾) :	隨機播放當前文件夾的所有曲目，然後播放下一文件夾的所有曲目

使用清單畫面操作 (DivX / MPEG 視頻 / MP3 / WMA / WAV)

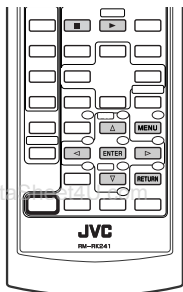

這些操作可使用遙控器在顯示器上進行。

您可以在播放之前顯示文件夾清單 / 曲目清單來確定碟片內容並開始播放。

- 1 在停止狀態下顯示文件夾清單。



- 2 從文件夾清單中選擇一個項目。



- 所選文件夾的曲目清單出現。
- 想要返回文件夾清單，按 **RETURN** 鍵。

- 3 選擇一個曲目開始播放。



- MP3/WMA/WAV：控制畫面出現（參閱第 17 頁）。

清單畫面

Folder: 153/240		Track: 154/198		Page: 4/ 6	
fol130	fol140	fol150	fol160		
fol131	fol141	fol151	fol161		
fol132	fol142	fol152	fol162		
fol133	fol143	fol153	fol163		
fol134	fol144	fol154	fo 164		
fol135	fol145	fol155	fo 165		
fol136	fol146	fol156	fo 166		
fol137	fol147	fol157	fo 167		
fol138	fol148	fol158	fo 168		
fol139	fol149	fol159	fo 169		

例：文件夾清單

- 1 當前文件夾號碼 / 總文件夾數量
- 2 當前文件夾的當前曲目號碼 / 總曲目數量
- 3 清單中的當前頁面 / 總頁面數量
- 4 當前文件夾 / 曲目 (突出顯示欄)

切換顯示信息
(參閱第 11 頁)

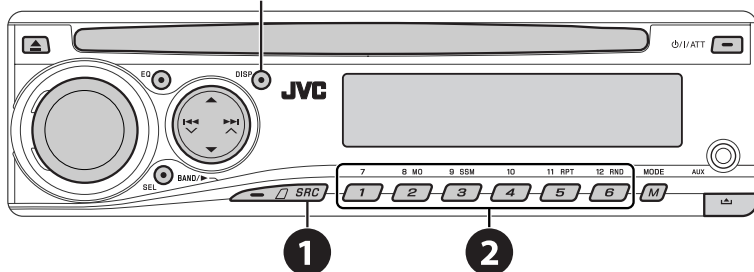

建議您在本機上使用 JVC MP3 兼容式 CD 換碟器。

- 您僅能播放傳統型 CD (包括文本 CD) 及 MP3 碟片。

❶ 選擇 “CD-CH”。

❷ 選擇碟片開始播放。

按：對應選擇碟片號碼 1-6。

按住：對應選擇碟片號碼 7-12。

	按：選擇曲目 按住：倒退 / 快進曲目
	MP3：選擇文件夾

MODE
按 **M** 鍵後，按下列按鍵進行以下操作...

	跳播 10 首曲目 (MP3：在同一文件夾內)
	TRK RPT ：重複播放當前曲目 FLDR RPT ：MP3：重複播放當前文件夾的所有曲目 DISC RPT ：重複播放當前碟片的所有曲目
	FLDR RND ：MP3：隨機播放當前文件夾的所有曲目，然後播放下一文件夾的曲目 DISC RND ：隨機播放當前碟片的所有曲目 MAG RND ：隨機播放所裝碟片的所有曲目

- 想要取消重複播放或隨機播放，選擇 “RPT OFF” 或 “RND OFF”。

收聽 iPod/D. 播放機

中文

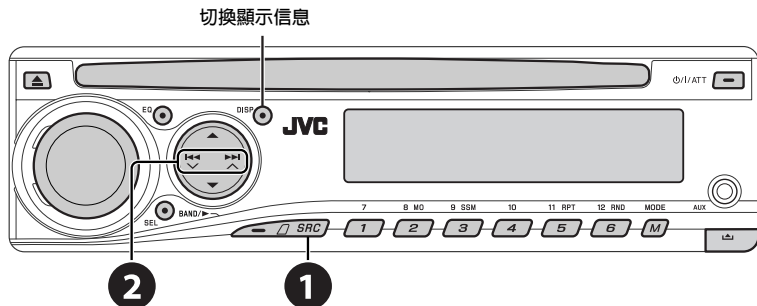

切換顯示信息

在操作之前：將以下任意一項（另購）連接至本機後面板上的 CD 換碟器插孔。

- iPod 界面適配器—KS-PD100 用於控制 iPod。
- D. 播放機界面適配器—KS-PD500 用於控制 D. 播放機。

www.DataSheet4U.com

準備事項：

確定在外接輸入設定中選擇“CHANGER”，參閱第 24 頁。

- 1 選擇“IPOD”或“D. PLAYER”。
- 2 選擇歌曲開始播放。

從菜單中選擇曲目

1 進入主菜單。



- 若大約 5 秒鐘內沒有進行任何操作，此模式將被取消。

2 選擇所需菜單。



對應 iPod：

PLAYLIST ↔ ARTISTS ↔ ALBUMS ↔ SONGS
↔ GENRES ↔ COMPOSER ↔ （返回至開始處）

對應 D. 播放機：

PLAYLIST ↔ ARTIST ↔ ALBUM ↔ GENRE
↔ TRACK ↔ （返回至開始處）

3 確認選擇。



- 想要返回到之前的菜單，按 ▲ 鍵。
- 若選擇一個曲目，播放自動開始。
- 按住 ◀◀ ◻ ▶▶ 鍵可一次跳過 10 個項目。



暫停 / 停止播放

- 想要重新開始播放，再按一次該鍵。



按：選擇曲目

按住：倒退 / 快進曲目

MODE

按 **M** 鍵後，按下列按鍵進行操作...

11 RPT 5	ONE RPT : 功能同“重複播放 單首”或“重複模式 → 一曲”。
	ALL RPT : 功能同“重複播放 全部”或“重複模式 → 全部”。
12 RND 6	ALBM RND* : 功能同 iPod 中的“隨機播放 專輯”。
	SONG RND/RND ON : 功能同“隨機播放 歌曲”或“隨機播放 → 開”。

• 想要取消重複播放或隨機播放，選擇“RPT OFF”或“RND OFF”。

* iPod：僅當主“MENU”中的“ALBUMS”中選擇“ALL”時有效。

收聽其他外接組件

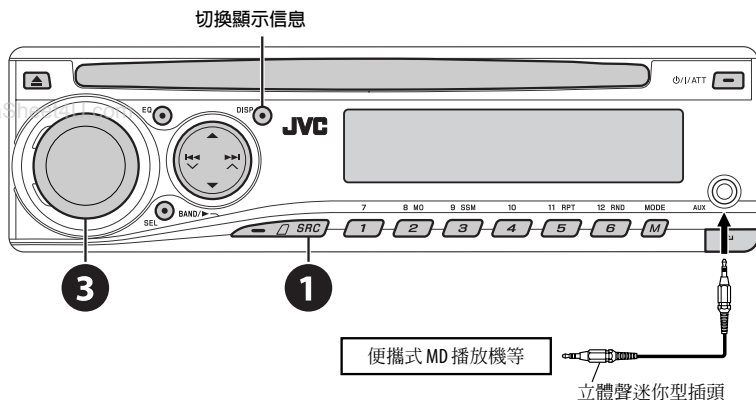

您可以將一個外接組件連接至：

- 使用**線性輸入適配器**—KS-U57（另購）或**AUX 輸入適配器**—KS-U58（另購）將其連接至後面板上的 CD 換碟器插孔。確保“EXT IN”被選為外部輸入設定，參閱第 24 頁。
- 後面板上的 LINE IN 插孔。（僅對應 KD-DV5306/KD-DV5305）。
- 控制面板上的 AUX 輸入端子（僅對應 KD-DV5306/KD-DV5305）。

- 1 選擇“EXT IN”，“LINE IN”或“AUX IN”。
- 2 啟動所連接的組件並開始播放播放源。
- 3 調整音量。
- 4 根据需要調整聲音（參閱第 22 和 23 頁）。

選擇預設聲音模式

中文

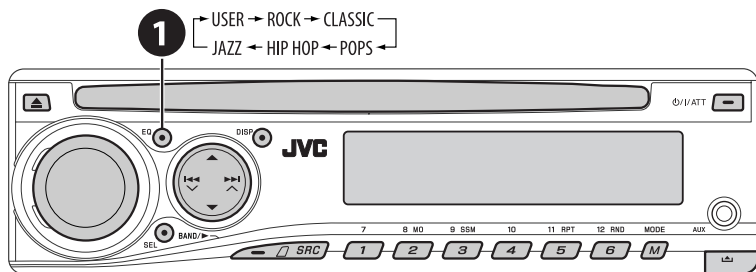

顯示 (對應)	預設值	BAS (低音)	TRE (高音)	LOUD (響亮度)
USER (平音)		00	00	OFF
ROCK (搖滾或迪斯科音樂)		+03	+01	ON
CLASSIC (古典音樂)		+01	-02	OFF
POPS (輕音樂)		+04	+01	OFF
HIP HOP (Funk 或 rap 音樂)		+02	00	ON
JAZZ (爵士樂)		+02	+03	OFF

調整聲音



2 調整音量水平。



BAS *1 (低音) 調整低音。	-06 至 +06
TRE *1 (高音) 調整高音。	-06 至 +06
FAD *2 (弱化) 調整前置和後置揚聲器的平衡。	R06 至 F06
BAL (平衡) 調整左置和右置揚聲器的平衡。	L06 至 R06
LOUD *1 (響亮度) 在音量水平較低的情況下，提高低頻及高頻的音量以達到更好的平衡效果。	LOUD ON 或 LOUD OFF
VOL.A *3 (音量調整) 根據 FM 音量水平為每個信號源調整並儲存音量水平。	-05 至 +05； 初始設定： 00
VOL (音量) 調整音量。	00 至 30 (或 50) *4

*1 在調整低音、高音或響亮度時，您所作的調整將儲存在當前所選的聲音模式 (C-EQ)，包括“USER”。

*2 如果您使用的是雙揚聲器系統，把弱化設定為“00”。

*3 如果播放源為 FM 電臺時，您不能做任何調整。“FIX”字樣出現。

*4 取決於放大器增益控制的設定。(詳情參閱第 24 頁。)

一般設定 — PSM

您可以切換第 24 頁表格中所列的 PSM (優先設置模式) 項目。

1 進入 PSM 設定。



2 選擇一個 PSM 項目。



3 選擇或調整所選的 PSM 項目。



4 如需要，重複步驟 2 和 3 調整其他 PSM 項目。

5 完成設定。



顯示	項目 (_: 初始設定)	可選擇的設定，【參考頁碼】
DEMO 屏幕演示	<ul style="list-style-type: none"> • DEMO ON • DEMO OFF 	<ul style="list-style-type: none"> : 如果在 20 秒左右沒有對本機進行任何操作，屏幕演示將自動開始播放，[5]。 : 取消。
CLK DISP *1 時鐘顯示	<ul style="list-style-type: none"> • ON • OFF 	<ul style="list-style-type: none"> : 電源關閉時，時間將一直在顯示屏上顯示。 : 取消；電源關閉時，按 DISP 鍵將顯示時間約 5 秒鐘，[5]。
CLOCK H 小時調整	1 – 12	: [初始設定：1 (1:00)]，[5]。
CLOCK M 分鐘調整	00 – 59	: [初始設定：00 (1:00)]，[5]。
DIMMER 減光器	<ul style="list-style-type: none"> • ON • OFF 	<ul style="list-style-type: none"> : 調暗顯示屏的亮度。 : 取消。
SCROLL *2 滾動	<ul style="list-style-type: none"> • ONCE • AUTO • OFF 	<ul style="list-style-type: none"> : 滾動曲目信息一次。 : 重複滾動（間隔 5 秒）。 : 取消。（按住 DISP 滾動顯示，與設定無關。）
EXT IN *3 外接輸入	<ul style="list-style-type: none"> • CHANGER • EXT IN 	<ul style="list-style-type: none"> : 要使用 JVC CD 換碟器時，[19]，或 Apple iPod/JVC D. 播放機，[20]。 : 要使用以上之外其他外接組件時，[21]。
TAG DISP 標籤顯示	<ul style="list-style-type: none"> • TAG ON • TAG OFF 	<ul style="list-style-type: none"> : 當播放 MP3/WMA/WAV 曲目時顯示標籤。 : 取消。
VIDEO *4 視頻格式	<ul style="list-style-type: none"> • PAL • NTSC 	<ul style="list-style-type: none"> : 如果您的顯示器為 PAL 顏色制式，選擇此項。 : 如果您的顯示器為 NTSC 顏色制式，選擇此項。
AMP GAIN 放大器增益控制	<ul style="list-style-type: none"> • LOW PWR • HIGH PWR 	<ul style="list-style-type: none"> : VOL 00 – VOL 30（如果每個揚聲器的最大功率小於 50 W 時，為避免損壞揚聲器，選擇此項。） : VOL 00 – VOL 50
IF BAND 中頻濾波器	<ul style="list-style-type: none"> • AUTO • WIDE 	<ul style="list-style-type: none"> : 增強鄰近電臺的調諧器選擇性以減少相互間的噪音干擾。（立體聲效果可能會消失。） : 受鄰近電臺噪音干擾的影響，音質不會降低且保留立體聲效果。

*1 如果電源在關閉汽車點火開關時不中斷，建議選擇“OFF”節省汽車電量。

*2 某些字符或符號將不會在顯示屏上正確顯示（或將會被留白）。

*3 僅當選擇下面一種播放源時顯示—FM，AM，DISC，及對應 KD-DV5306/KD-DV5305 時的 LINE IN 或 AUX IN。

*4 最新選擇的視頻格式僅在您重新啟動電源或切換播放源之後才會生效。

碟片設定菜單

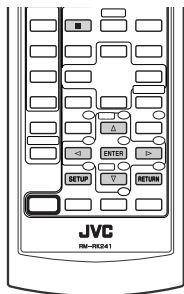

這些操作可使用遙控器在顯示器上進行。

- 1 在停止狀態下，進入碟片設定菜單。



- 2 選擇菜單。

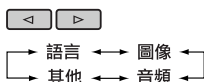

- 3 選擇想要設定的項目。



- 想要取消下拉菜單，按 **RETURN** 鍵。

- 4 選擇一個選項。

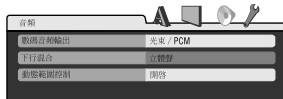
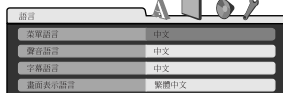

如何返回標準畫面



注意：可以使用“語言”設定切換畫面表示語言（參閱下列內容）。本機的出廠設定為“英語”。

菜單	項目	設定
軌道	菜單語言	選擇初始碟片菜單語言。另參閱第 33 頁的“語言代碼”。
	聲音語言	選擇初始聲音語言。另參閱第 33 頁的“語言代碼”。
	字幕語言	選擇初始字幕語言或刪除字幕（關閉）。另參閱第 33 頁的“語言代碼”。
	畫面表示語言	選擇屏幕顯示語言。

菜單	項目	設定
圖像	屏幕類型 選擇顯示類型，以在顯示器上觀賞寬屏畫面。 16:9 4:3 信箱屏幕 4:3 全景屏幕 	
	OSD 顯示位置 選擇顯示器上屏幕菜單欄的位置。 • 1 : 靠上 • 2 : 靠下 (DVD 設定菜單下的指示信息將不會出現。)	
	文件類型 選擇需要播放的文件類型。 • 音頻 : 播放 MP3/WMA/WAV 文件。 • 視頻 : 播放 DivX / MPEG 視頻文件。	
音頻	數碼音頻輸出 選擇自後面板 DIGITAL OUT 端子 (光學端子) 輸出的信號格式。 • 關閉 : 取消。 • PCM : 在連接與杜比數碼, DTS, 音頻 MPEG 不兼容的放大器或解碼器時, 或與錄音設備相連接時選此項。 • DOLBY DIGITAL/PCM : 在連接與杜比數碼兼容的放大器或解碼器時選此項。 • 光束 / PCM : 在連接與杜比數碼, DTS 和音頻 MPEG 兼容的放大器或解碼器時選此項。	
	下行混合 在播放多聲道碟片時, 此設定會影響從 LINE OUT 插孔 (及當為“數碼音頻輸出”選擇“PCM”時從 DIGITAL OUT 端子) 輸出的信號。 • 環繞兼容 : 在將與杜比環繞聲兼容的放大器連接至本機時, 選擇此項以欣賞多聲道環繞聲音效。 • 立體聲 : 一般情況下選擇此項。	
	動態範圍控制 在播放杜比數碼軟體的過程中, 您可以在低音量或中音量水平下欣賞強勁音效。 • 自動 : 選擇此項以在多聲道編碼的軟體 (不包括單聲道和雙聲道軟體) 中增強此效果。 • 開啓 : 想要一直使用此功能時選擇此項。	
其他	DivX 認證	本機有注冊代碼。如果您播放灌錄有注冊代碼的碟片時, 本機的注冊代碼會因版權保護而被改寫。

為播放源命名

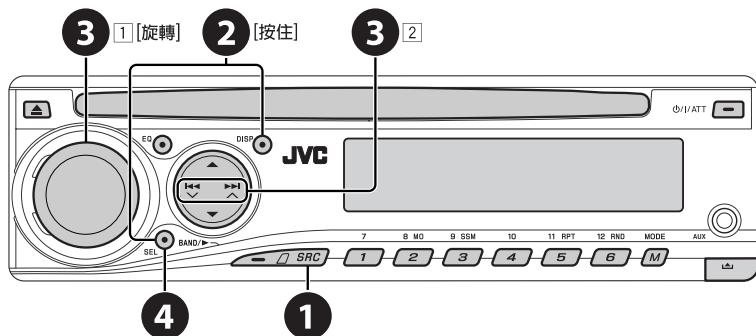

您可以為 30 個電臺頻率（FM 和 AM）命名且每個電臺名稱最多 8 個字符。

- 1 選擇 FM/AM。
- 2 出現名稱輸入畫面。
- 3 命名。
 - 1 選擇一個字符。
 - 2 移至後一個（或前一個）字符位。
 - 3 重複步驟 1 和 2，直到完成名稱輸入。
- 4 完成設定。

如何清除整個名稱

在左欄步驟 2 中...



可供使用的字符

A	B	C	D	E	F	G	H	I	J	K	L	M	N
O	P	Q	R	S	T	U	V	W	X	Y	Z	0	1
2	3	4	5	6	7	8	9	-	/	<	>	空格	

如何清潔連接器

經常性的拆卸會損壞連接器。爲了降低這種可能性，定期用棉條或布沾酒精擦拭，要小心避免損壞連接器。

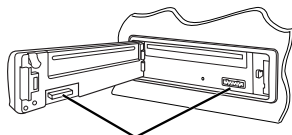

連接器

水蒸氣結露

在下列情況下，本機內部的鏡頭可能發生水蒸氣結露：

- 打開車內取暖器後。
 - 若車內異常潮濕。
- 發生此種情況時，本機可能出現故障。此時可彈出碟片，將主機啓動幾個小時，直到結露蒸發掉。

如何保養碟片

當將碟片從盒中取出時，握持碟片的邊緣，同時按下盒內的中央鈕將其取出。

- 需握持碟片的邊緣。切勿觸摸其錄音面。

欲將碟片放回盒中時，將碟片輕輕套在中央鈕上（使印刷面朝上）。

- 使用後務必將碟片放入盒中保存。

中央鈕



如何保持碟片的清潔

髒污的碟片可能無法正確播放。如果碟片確實髒污，用軟布從中心到邊緣直線擦拭。

- 切勿使用任何溶劑（例如：傳統的錄音清潔劑，噴霧劑，稀釋劑，輕油精等）來清潔碟片。



如何播放新碟片

新碟片的裡面邊緣和外邊緣上可能有一些粗糙的污點。使用這樣的碟片時，本機可能將其退出。

若要去除這些粗糙的污點時，用鉛筆或圓珠筆等擦拭碟片的邊緣。



切勿使用下列碟片：

彎曲的碟片



黏貼紙



黏貼紙標籤



上面貼的標籤



形狀異常

關於本接收機的附加信息

■ 一般操作

啓動電源

- 按本機上的 SRC 鍵，您也可以啓動電源。若播放源已準備好，播放開始。

關閉電源

- 如果您在聆聽碟片時關閉電源，下次啓動電源時，碟片會自動播放。

■ FM/AM

將電臺存儲在記憶體中

- 在 SSM 搜索過程中...
 - 接收到的電臺被預設到號碼 1（頻率最低的電臺）至號碼 6（頻率最高的電臺）。
 - SSM 結束後，自動調收儲存在號碼 1 裡的電臺。
- 儲存電臺時，原來的預設電臺被抹除，新的電臺被儲存。

■ 碟片

一般操作

- 在本使用手冊中，單詞“曲目”和“文件”交替用來指代 DivX / MPEG 視頻 / MP3 / WMA / WAV 文件及其文件名稱。
- 本機也可以播放 8 公分的碟片。
- 如果同一張碟片中錄製有不同類型的文件，本機僅能播放音頻 CD（CD-DA）。

裝入碟片

- 如果碟片被正面朝下顛倒裝入時，“PLEASE”和“EJECT”交替出現。按 ▲ 鍵彈出碟片。

彈出碟片

- 如果 15 秒以內彈出的碟片沒有被拿出，碟片會自動再次插入載槽以免被弄髒。碟片自動播放。

- 碟片彈出後，“NO DISC”字樣出現，您不能操作某些按鍵。裝入另一張碟片或按 SRC 鍵選擇另一個播放源。

播放可錄製 / 可反復錄製碟片

- 本機總共可以識別 5 000 個文件和 250 個文件夾（每個文件夾最多 999 個文件）。
- 本機可識別的文件夾 / 文件名稱最多允許 25 個字符。
- 僅可使用“格式化”之後的碟片。
- 本機可播放多區段數據碟片，但在播放時將跳過未關閉的區段。
- 基於碟片本身的特性或錄製情況的不同，本機可能無法播放某些碟片或文件。
- 可反復錄製碟片可能需要較長的讀取時間。

播放 MP3/WMA/WAV 文件

- 文件夾和文件名稱最多允許的字符是 25 個字符；MP3/WMA/WAV 標籤信息最多允許 128 個字符。
- 本機可以播放帶有增設碼為 <.mp3>，<.wma> 或 <.wav> 的文件（不論字母大小寫）。
- 本機可顯示 MP3/WMA/WAV 文件的專輯名稱，藝術家（表演者）和標籤（版本 1.0，1.1，2.2，2.3 或 2.4）。
- 本機僅能處理單字節字符。其他字符無法正確顯示。
- 本機可以播放以 VBR（可變比特率）錄製的文件。以 VBR 錄製的文件在顯示已過播放時間上會有差異。
- 本機不能播放下列文件：
 - 以 MP3i 和 MP3 PRO 格式編碼的 MP3 文件。
 - 以 1/2 層編碼的 MP3 文件。
 - 以無損的，專業的聲音格式編碼的 WMA 文件。
 - 非基於 Windows Media® Audio 的 WMA 文件。

- 以 DRM 拷貝保護的 WMA 格式文件。
- 包含如 ATRAC3 等數據的文件。
- AAC 文件和 OGG 文件。

播放 DivX 文件

- 本機可播放帶有增設碼為 <.divx> , <.div> , <.avi> 的 DivX 文件（無論字母大小寫）。
- 本機可播放 DivX 6.x , 5.x , 4.x 和 3.11 文件。
- 本機可播放帶有增設碼為 <.divx> 或 <.avi> 的 DivX Media 制式的文件。
- 本機可播放唯一註冊碼—DivX 視頻點播（VOD—一種數位版權管理）。有關播放及更多的詳情，訪問以下網站 <www.divx.com/vod>。
- 音頻流應當同 MP3 或杜比數碼相一致。
- 本機不能播放 GMC 文件（全域動態壓縮）。
- 本機不能正確播放以隔行掃描模式解碼的文件。
- 目錄搜索：

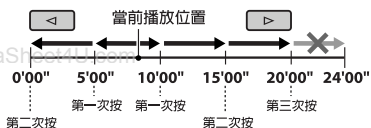

- 本機不能播放以下文件：
 - 除了 DivX Codec 以外的任何以 Codec（壓縮器 / 解壓縮器）制式錄製的文件。
- 想要知道有關 DivX 的更多詳情，訪問以下網站 <<http://www.divx.com>>。

播放 MPEG 視頻文件

- 本機可播放帶有增設碼為 <.mpg> 或 <.mpeg> 的 MPEG 視頻制式的文件。
- 音頻流應當同 MPEG1 Audio Layer 2 相一致。
- 本機不能播放以下文件：
 - WMV（Windows Media Video）文件
 - RM（Real Media）制式文件

切換播放源

- 如果您切換播放源，播放也會停止（碟片不會彈出）。下次您選擇“DISC”為播放源時，碟片會從上次停止的地方開始播放。

iPod 或 D. 播放機

- 啓動本機時，iPod 或 D. 播放機通過本機進行充電。
- 當連接 iPod 或 D. 播放機時，將不能從 iPod 或 D. 播放機進行操作。所有操作須在本機上進行。
- 文本信息可能不會正確顯示。
- 若文本信息包含多於 8 個字符，將在顯示屏上滾動顯示。本機最多可顯示 40 個字符。

注意：

操作 iPod 或 D. 播放機時，可能無法正確進行某些操作。此種情況下，訪問下列 JVC 網站：

對應 iPod 用戶：<<http://www.jvc.co.jp/english/car/support/ks-pd100/index.html>>

對應 D. 播放機用戶：<<http://www.jvc.co.jp/english/car/support/ks-pd500/index.html>>

命名標題

- 若要為多於 30 個電臺頻率命名，“NAMEFULL”字樣出現。命名前刪除不想要的標題。

一般設定—PSM

- 如果您在音量設定高於“VOL 30”時將“AMP GAIN”設定從“HIGH PWR”切換為“LOW PWR”，本機則會自動將音量水平切換為“VOL 30”。

碟片設定菜單

- 如果您選擇的語言未被錄製在碟片上，原始語言被自動用作初始語言。此外，由於內部碟片程序不同，某些碟片的初始語言設定無效。
- 當您為縱橫比為 4:3 的圖片選擇“16:9”時，圖片寬度的轉換會引起圖片稍微變形。
- 對應某些碟片，即使您選擇了“4:3 全景屏幕”，畫面尺寸也可能顯示為“4:3 信箱屏幕”。

有關自後面板端子輸出的聲音

- **自模擬端子（揚聲器輸出 / LINE OUT）：**輸出雙聲道信號。當播放多聲道編碼的碟片時，多聲道信號會被下行混合處理。不能再生 DTS 聲音。（音頻—下行混合：參閱第 26 頁。）
- **自 DIGITAL OUT 輸出（光學端子）：**
此端子輸出數碼信號（線性 PCM，Dolby Digital，DTS，音頻 MPEG）。（詳情參閱如下所示的圖表。）
想要獲得多聲道音響效果，如 Dolby Digital，DTS 和音頻 MPEG 時，將與多聲道音響效果相兼容的功率放大器或解碼器連接至該端子，並正確設定“數碼音頻輸出”。（參閱第 26 頁。）

自 DIGITAL OUT 端子輸出的信號

輸出信號隨設定菜單中“數碼音頻輸出”設定的不同而不同（參閱第 26 頁）。

播放碟片	輸出信號			關閉
	光束 / PCM	DOLBY DIGITAL/ PCM	PCM	
DVD-視頻	48 kHz，16/20/24 比特線性 PCM	48 kHz，16 比特立體聲線性 PCM *		關閉
	96 kHz，線性 PCM	48 kHz，16 比特立體聲線性 PCM		
	Dolby Digital	Dolby Digital 位流		
	DTS	DTS 位流		
音頻 MPEG	MPEG 位流	48 kHz，16 比特立體聲線性 PCM		
音頻 CD，視頻 CD	44.1 kHz，16 比特立體聲線性 PCM / 48 kHz，16 比特立體聲線性 PCM			
具 DTS 功能的音頻 CD	DTS 位流			
DivX	Dolby Digital	Dolby Digital 位流		
	音頻 MPEG	32/44.1/48 kHz，16 比特線性 PCM		
MPEG	44.1/48 kHz，16 比特線性 PCM			
MP3 / WMA	32/44.1/48 kHz，16 比特線性 PCM			
WAV	44.1 kHz，16 比特立體聲線性 PCM			

* 如果碟片未進行版權保護，數碼信號可能以 20 或 24 比特（它們的原始比特率）自 DIGITAL OUT 端子輸出。

屏幕指南圖標

在播放過程中，以下指南圖標可能會在顯示器上出現片刻。

▶：播放

⏸：暫停

▶▶：DVD-視頻 / VCD：慢動作前進

◀◀：DVD-視頻：慢動作回放

▶▶▶：快進搜索

◀◀◀：倒退搜索

DVD：以下圖標出現在影片的開始處包含：

☑：多字幕語言

🔊：多音頻語言

🎬：多角度欣賞

外接裝置連接的方案示意圖

- 關於如何連接，參閱安裝 / 連接手冊（別冊）。

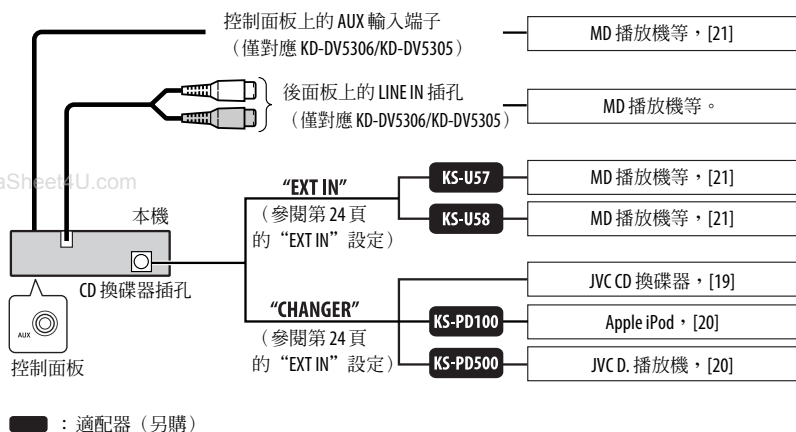

- 由 Dolby Laboratories 授權製造。杜比、Dolby 與雙 D 記號是 Dolby Laboratories 的商標。
- “DTS” 和 “DTS Digital Out” 是 DTS, Inc. 的註冊商標。
- “DVD Logo” 是 DVD 格式 / 標識許可公司在美國，日本和其他國家的註冊商標。
- DivX，DivX Ultra Certified 和相關標識是 DivX, inc 的商標，在許可下使用。
- 官方 DivX® Ultra Certified 產品。
- 播放具有增強播放功能的 DivX® 媒體文件和所有 DivX® 的媒體格式視頻版本（包括 DivX® 6）。
- Microsoft 和 Windows Media 是美國和 / 或其他國家微軟公司的註冊商標或商標。
- iPod 是 Apple Computer, Inc.（蘋果電腦公司）在美國及其他國家註冊的商標。

語言代碼

代碼	語言	代碼	語言	代碼	語言	代碼	語言	代碼	語言
AA	阿法爾語	FA	波斯語	KL	格陵蘭語	OC	奧克西唐語	ST	塞索托語
AB	阿布哈茲語	FI	芬蘭語	KM	柬埔寨語	OM	(阿梵) 奧洛莫語	SU	蘇丹語
AF	南非利堪斯語	FJ	斐濟語	KN	坎納達語	OR	奧利亞語	SW	斯瓦希利語
AM	阿姆哈拉語	FO	法羅斯語	KO	朝鮮語 (KOR)	PA	旁遮普語	TA	泰米爾語
AR	阿拉伯語	FY	弗里西亞語	KS	克什米爾語	PL	波蘭語	TE	泰盧固語
AS	阿薩姆語	GA	愛爾蘭語	KU	庫爾德語	PS	普什圖語	TG	塔吉克語
AY	埃馬拉語	GD	蘇格蘭語	KY	吉爾吉斯語	PT	葡萄牙語	TH	泰國語
AZ	阿塞拜疆語	GL	加利西亞語	LA	拉丁語	QU	凱楚亞語	TI	提格里尼亞語
BA	巴什基爾語	GN	瓜拉尼語	LN	林加拉語	RM	利托-羅曼語	TK	土庫曼語
BE	白俄羅斯語	GU	古吉拉特語	LO	老撾語	RN	基隆迪語	TL	塔加路族語
BG	保加利亞語	HA	豪薩語	LT	立陶宛語	RO	羅馬尼亞語	TN	塞茨瓦納語
BH	比哈爾語	HI	印地語	LV	拉托維亞語	RW	基尼阿萬達語	TO	湯加語
BI	比斯拉瑪語	HR	克羅地亞語	MG	馬達加斯加語	SA	梵語	TR	土耳其語
BN	孟加拉語	HU	匈牙利語	MI	毛利語	SD	信德語	TS	從咖語
BO	藏語	HY	亞美尼亞語	MK	馬其頓語	SG	桑戈語	TT	韃靼語
BR	布列塔尼語	IA	國際語 A	ML	馬拉亞拉姆語	SH	塞爾維亞克羅地亞語	TW	特維語
CA	加泰隆語	IE	國際語 E	MN	蒙古語	SI	僧加羅語	UK	烏克蘭語
CO	科西嘉語	IK	依努庇克語	MO	摩爾達維亞語	SK	斯洛伐克語	UR	烏爾都語
CS	捷克語	IN	印尼語	MR	馬拉提語	SL	斯洛文尼亞語	UZ	烏茲別克語
CY	威爾士語	IS	冰島語	MS	馬來語 (MAY)	SM	薩摩亞語	VI	越南語
DZ	不丹語	IW	希伯來語	MT	馬爾他語	SN	紹納語	VO	沃拉普克語
EL	希臘語	JI	依地語	MY	緬甸語	SO	索馬裡語	WO	沃洛夫語
EO	世界語	JW	爪哇語	NA	瑙魯語	SQ	阿爾巴尼亞語	XH	科薩語
ET	愛沙尼亞語	KA	格魯吉亞語	NE	尼泊爾語	SR	塞爾維亞語	YO	約魯巴語
EU	巴斯克語	KK	哈薩克語	NO	挪威語	SS	塞斯瓦替語	ZU	祖魯語

故障排除

所出現的問題並不總是嚴重的故障。在洽詢維修服務中心之前，請首先檢查下述要點。

中文

	症狀	措施 / 原因
一般	• 揚聲器不發出聲音。	• 將音量設定在合適的水平。 • 檢查導線和線路連接。
	• 本機完全不工作。	重設本機（參閱第 2 頁）。
FM/AM	• SSM 自動預設功能失效。	手動儲存電臺。
	• 收聽廣播時有靜電干擾。	將天線連接牢固。
一般碟片	• 不能播放碟片。	正確裝入碟片。
	• 不能播放和彈出碟片。	• 解鎖碟片（參閱第 11 頁）。 • 強制彈出碟片（參閱第 2 頁）。
	• 不能播放可錄制 / 可再編寫碟片。	• 裝入已格式化的碟片。
	• 不能跳播可錄制 / 可再編寫碟片上的曲目。	• 使用您用來錄音的組件將碟片格式化。
	• 不能識別碟片。	強制彈出碟片（參閱第 2 頁）。
	• 聲音及圖片有時中斷或失真。	• 行駛在崎嶇顛簸的道路上時，停止播放碟片。 • 更換碟片。 • 檢查導線和線路連接。
	• 無播放畫面（DVD 視頻 / DivX / MPEG / VCD）在顯示器上出現。	未正確連接手剎車線路。（參閱安裝 / 連接手冊。）
	• 無圖片在顯示器上出現。	• 正確連接視頻導線。 • 在顯示器上選擇正確的輸入。
	• 顯示器顯示黑白波紋圖片（DVD 視頻 / DivX / MPEG / VCD）。	為顯示器選擇合適的視頻格式（PAL / NTSC）（參閱第 24 頁）。
	• 圖片的左右邊緣在畫面上顯示不全。	選擇“4:3 信箱屏幕”（參閱第 26 頁）。
DivX / MPEG 視頻 / MP3 / WMA / WAV	• 碟片無法播放。	• 更換碟片。 • 用相應的應用程序在合適的碟片上錄製曲目（參閱第 4 頁）。 • 在文件名中加入增設碼 <.divx>，<.div>，<.avi>，<.mpg>，<.mpeg>，<.mp3>，<.wma> 或 <.wav>。
	• 產生噪音。	跳至另一首曲目或更換碟片。

	症狀	措施 / 原因
DivX / MPEG 視頻 / MP3 / WMA / WAV	• 需要較長的讀取時間。	讀取時間因文件夾 / 文件設置的複雜程度而異。切勿使用太多層級和文件夾。
	• 您想播放的曲目無法播放。	播放順序在文件錄製時已決定。
	• 播放 DivX / MPEG 視頻文件過程中，顯示圖片時無聲音傳出。	<ul style="list-style-type: none"> • 使用 MP3 或杜比數碼作為 DivX 文件的音頻流錄製音頻曲目。 • 使用 MPEG1 Audio Layer 2 作為 MPEG 視頻文件的音頻流錄製音頻曲目。
	• 已過播放時間不正確。	在播放過程中有時會發生此種情況。原因出自曲目如何錄製。
	• “PLEASE” 和 “EJECT” 字樣在顯示屏上交替出現。	裝入含有合適制式曲目的碟片。
	• 不能正確顯示字符（例如專輯名稱）。	本機僅能顯示字母（大寫），數字和有限的符號。
CD 換碟器	• “NO DISC” 字樣在顯示屏上出現。	將碟片裝入碟片倉中。
	• “NO MAG” 字樣在顯示屏上出現。	置入碟片倉。
	• “RESET 8” 字樣在顯示屏上出現。	正確連接本機與 CD 換碟器，並按 CD 換碟器上的重設鍵。
	• “RESET 1” – “RESET 7” 字樣在顯示屏上出現。	按 CD 換碟器上的復原設定鍵。
	• CD 換碟器完全不工作。	重設本機（參閱第 2 頁）。
iPod/D. 播放機	• iPod 或 D. 播放機不能啟動或根本無法工作。	<ul style="list-style-type: none"> • 檢查連接電纜及其連接。 • 為電池充電。 • 更新固件版本。
	• 聲音失真。	關閉本機或 iPod/D. 播放機上的均衡器。
	• “NO IPOD” 或 “NO DP” 字樣在顯示屏上出現。	<ul style="list-style-type: none"> • 檢查連接電纜及其連接。 • 為電池充電。
	• 播放停止。	耳機在播放過程中斷開連接。重新開始播放（參閱第 20 頁）。
	• 連接 iPod nano 時，沒有聲音傳出。	<ul style="list-style-type: none"> • 將 iPod nano 上的耳機斷開連接。 • 更新 iPod nano 上的固件版本。
	• 沒有聲音傳出。 • 連接 D. 播放機時 “ERROR 01” 字樣在顯示屏上出現。	斷開適配器與 D. 播放機的連接。然後，重新進行連接。

症狀	措施 / 原因
<ul style="list-style-type: none"> “NO FILES” 或 “NO TRACK” 字樣在顯示屏上出現。 	未儲存曲目。將曲目輸入 iPod 或 D. 播放機。
<ul style="list-style-type: none"> “RESET 1” – “RESET 7” 字樣在顯示屏上出現。 	斷開適配器與本機和 iPod/D. 播放機的連接。然後，重新進行連接。
<ul style="list-style-type: none"> “RESET 8” 字樣在顯示屏上出現。 	檢查適配器與本機的連接。
<ul style="list-style-type: none"> 與本機斷開連接後，iPod 或 D. 播放機控制無法操作。 	重設 iPod 或 D. 播放機。

規格

音頻放大器部分	最大輸出功率：	前 / 後聲道：	每聲道 50 W
	連續輸出功率 (RMS)：	前 / 後聲道：	每聲道 19 W，在 40 Hz 至 20 000 Hz 時驅動於 4 Ω，總諧波失真不超過 0.8%
	負載阻抗：		4 Ω (4 Ω 至 8 Ω 容限)
	音調控制範圍：	低音：	在 100 Hz 時 ±12 dB
		高音：	在 10 kHz 時 ±12 dB
	信噪比：		70 dB
	音頻輸出水平：	數碼 (DIGITAL OUT：光學端子)：	信號波長：660 nm
			輸出水平：-21 dBm 至 -15 dBm
		線性輸出水平 / 阻抗：	2.5 V/20 kΩ 負載 (滿刻度)
		輸出阻抗：	1 kΩ
顏色制式：		PAL/NTSC	
視頻輸出 (複合)：		1 Vp-p/75 Ω	
其他端子：	KD-DV5306/KD-DV5305：CD 換碟器，LINE IN，AUX (外接組件) 輸入插孔 KD-DV4306/KD-DV4305：CD 換碟器		

調諧器部分	頻率範圍：	FM：	87.5 MHz 至 108.0 MHz
		AM：	531 kHz 至 1 602 kHz
	FM 調諧器：	有效靈敏度：	11.3 dBf (1.0 μ V/75 Ω)
		50 dB 靜噪靈敏度：	16.3 dBf (1.8 μ V/75 Ω)
		交流聲道選擇性 (400 kHz)：	65 dB
		頻率響應：	40 Hz 至 15 000 Hz
	立體聲分隔頻率：	30 dB	
AM 調諧器：	靈敏度 / 選擇性：	20 μ V/35 dB	

DVD/CD 播放機部分	信號檢測系統：	無接合光學拾波 (半導體鐳射)		
	聲道數：	雙聲道 (立體聲)		
	頻率響應：	DVD, $f_s=48$ kHz/96 kHz：	16 Hz 至 22 000 Hz	
		CD, $f_s=44.1$ kHz：	16 Hz 至 20 000 Hz	
	動態範圍：	96 dB		
	信噪比：	98 dB		
	抖晃率：	小到不可測量		
	DivX / MPEG 視頻	視頻：	最大解析度：	720 \times 480 像素 (30 fps) 720 \times 576 像素 (25 fps)
			音頻：	比特率： DivX：32 kbps – 320 kbps MPEG 視頻：32 kbps – 384 kbps
			抽樣率：DivX：	MPEG-1：32 kHz, 44.1 kHz, 48 kHz MPEG-2：16 kHz, 22.05 kHz, 24 kHz
			抽樣率：MPEG 視頻：	32 kHz, 44.1 kHz, 48 kHz
	MP3：	比特率：	32 kbps – 320 kbps	
		抽樣率：	MPEG-1：32 kHz, 44.1 kHz, 48 kHz MPEG-2：16 kHz, 22.05 kHz, 24 kHz	
	WMA：	比特率：	32 kbps – 320 kbps	
抽樣率：		22.05 kHz, 32 kHz, 44.1 kHz, 48 kHz		
WAV：	量子比特率：	16 bit		
	抽樣率：	44.1 kHz		

一般資訊	電源要求：	操作電壓：	DC 14.4 V (允許 11 V 至 16 V)	
	接地系統：	負極接地		
	允許操作溫度：	0°C 至 +40°C		
	體積 (寬 \times 高 \times 深)：	安裝尺寸 (大約)：	182 mm \times 52 mm \times 158 mm	
		面板尺寸 (大約)：	187 mm \times 58 mm \times 13 mm	
重量 (大約)：	1.6 kg (不包括附件)			

設計和規格若有變更恕不另行通知。

Having TROUBLE with operation?

Please reset your unit

Refer to page of How to reset your unit

在操作時遇到麻煩了？

請重設本機

參閱如何重設本機之頁

JVC



EN, CT

© 2006 Victor Company of Japan, Limited

www.DataSheet4U.com

1206DTSMDTJEIN