

JVC

www.DataSheet4U.com

CD RECEIVER

KD-G731

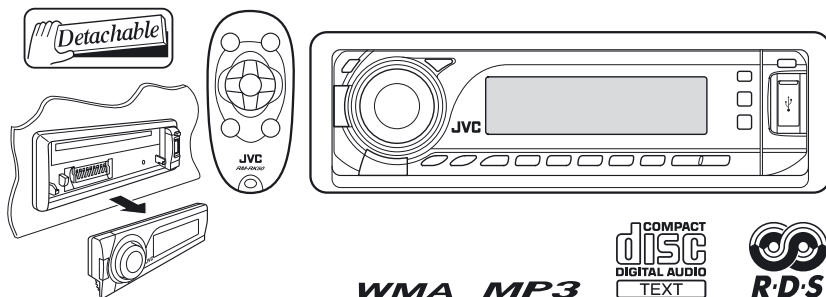

WMA MP3

COMPACT
disc
DIGITAL AUDIO
TEXT

R-D-S

For canceling the display demonstration, see page 4.

For installation and connections, refer to the separate manual.

INSTRUCTIONS

www.DataSheet4U.com
GET0431-003A
[EX/EU]

Thank you for purchasing a JVC product.

Please read all instructions carefully before operation, to ensure your complete understanding and to obtain the best possible performance from the unit.

www.DataSheet4U.com

IMPORTANT FOR LASER PRODUCTS

1. CLASS 1 LASER PRODUCT
2. **CAUTION:** Do not open the top cover. There are no user serviceable parts inside the unit; leave all servicing to qualified service personnel.
3. **CAUTION:** Visible and/or invisible class 1M laser radiation when open. Do not view directly with optical instruments.
4. REPRODUCTION OF LABEL: CAUTION LABEL, PLACED OUTSIDE THE UNIT.

CAUTION	ATTENTION	AVISO	WARNING	注意	CAUTION
VISIBLE AND/OR INVISIBLE CLASS 1M LASER RADIATION WHEN OPEN. DO NOT VIEW DIRECTLY WITH OPTICAL INSTRUMENTS. IEC60825-1:2001 (EN)	RAYONNEMENT LASER VISIBLE ET/OU INVISIBLE DE CLASSE 1M. NE PAS REGARDER DIRECTEMENT AVEC DES INSTRUMENTS OPTIQUES. (FR)	RADIACION LASER DE CLASE 1M VISIBLE Y/O INVISIBLE CUANDO ESTA ABIERTO. NO MIRAR DIRECTAMENTE CON INSTRUMENTAL OPTICO. (ES)	SYNLIG OCH/ELLER OSYNLIG LASERSTRÅLNING, KLASS 1M, NÅR DENNA DEL ÄR ÖPPNAD. BETRÄKTA EJ STRÅLEN MED OPTISKA INSTRUMENT. (SWE)	ここを開くと可視 及び/または不可視 のクラス1M レーザー放射が 発生す。 光学機器で直接 見ないでください。 (JPN)	VISIBLE AND/OR INVISIBLE CLASS II LASER RADIATION WHEN OPEN. DO NOT STARE INTO BEAM. FDA 21 CFR (EN)

Warning:

If you need to operate the unit while driving, be sure to look around carefully or you may be involved in a traffic accident.



This symbol is only valid in the European Union.

Information for Users on Disposal of Old Equipment

This symbol indicates that the product with this symbol should not be disposed as general household waste at its end-of-life. If you wish to dispose of this product, please do so in accordance with applicable national legislation or other rules in your country and municipality. By disposing of this product correctly, you will help to conserve natural resources and will help prevent potential negative effects on the environment and human health.

How to reset your unit

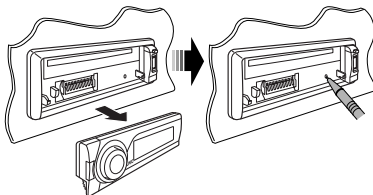

- Your preset adjustments will also be erased (except the registered Bluetooth device, see page 14).

How to forcibly eject a disc

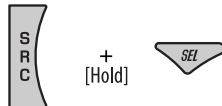

"PLEASE" and "EJECT" appear alternately on the display.

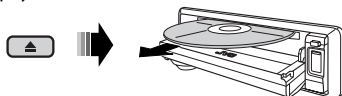

- Be careful not to drop the disc when it ejects.
- If this does not work, reset your unit.

www.DataSheet4U.com

How to use functions mode

If you press M MODE, the unit goes into functions mode, then the number buttons (except "4") and ▲/▼ buttons work as different function buttons.

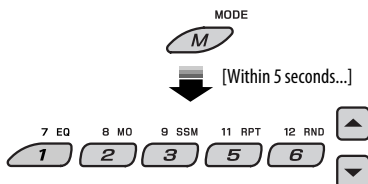

Caution on volume setting:

Discs and connected USB devices produce very little noise compared with other sources. Lower the volume before playing to avoid damaging the speakers by the sudden increase of the output level.

Note: Only for [EX] model users in UK and European countries

For security reasons, a numbered ID card is provided with this unit, and the same ID number is imprinted on the unit's chassis. Keep the card in a safe place, as it will help the authorities to identify your unit if stolen.

For safety...

- Do not raise the volume level too much, as this will block outside sounds, making driving dangerous.
- Stop the car before performing any complicated operations.

Temperature inside the car...

If you have parked the car for a long time in hot or cold weather, wait until the temperature in the car becomes normal before operating the unit.

CONTENTS

INTRODUCTIONS

<i>Preparation</i>	4
--------------------------	---

OPERATIONS

<i>Basic operations</i>	5
• <i>Using the control panel</i>	5
• <i>Using the remote controller (RM-RK50)</i>	6
<i>Listening to the radio</i>	8
<i>Searching for FM RDS programme</i>	
— <i>PTY Search</i>	9
<i>Disc operations</i>	11
<i>Listening to the USB device</i>	12

EXTERNAL DEVICES

<i>Using the Bluetooth® devices</i>	14
• <i>Using the Bluetooth cellular phone</i>	16
• <i>Using the Bluetooth audio player</i>	18
<i>Listening to the CD changer</i>	18
<i>Listening to the DAB tuner</i>	20
<i>Listening to the iPod / D. player</i>	21
<i>Listening to the other external components</i>	22

SETTINGS

<i>Selecting a preset sound mode</i>	24
<i>General settings—PSM</i>	25
<i>Bluetooth settings</i>	28

REFERENCES

<i>Maintenance</i>	29
<i>More about this unit</i>	30
<i>Troubleshooting</i>	34
<i>Specifications</i>	38

Preparation

Cancel the display demonstration and set the clock

- See also page 26.

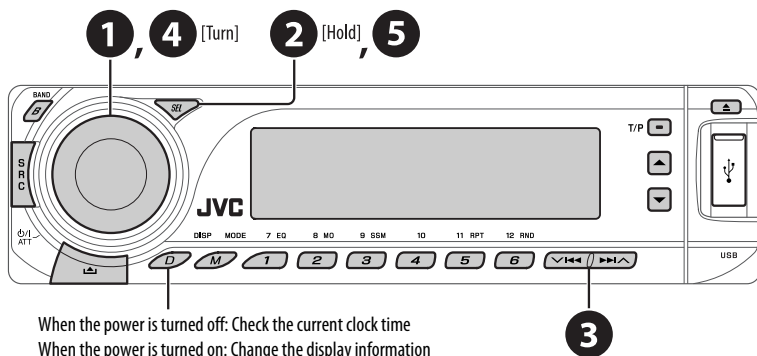

- 1 Turn on the power.**
- 2 Enter the PSM settings.**
- 3 ⇒ 4 Cancel the display demonstrations**
Select "DEMO," then "DEMO OFF."
- Set the clock**
Select "CLOCK H" (hour), then adjust the hour.
Select "CLOCK M" (minute), then adjust the minute.
Select "24H/12H," then "24H" (hour) or "12H" (hour).
- 5 Finish the procedure.**

Detaching the control panel

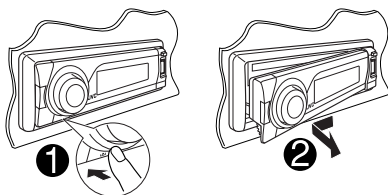

Attaching the control panel

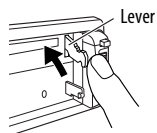
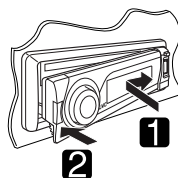

CAUTION:

The lever comes out if you pressed the ▲ button while the panel is detached. If this happens, push the lever back into lock position before attaching the panel.

www.DataSheet4U.com

Basic operations

Using the control panel

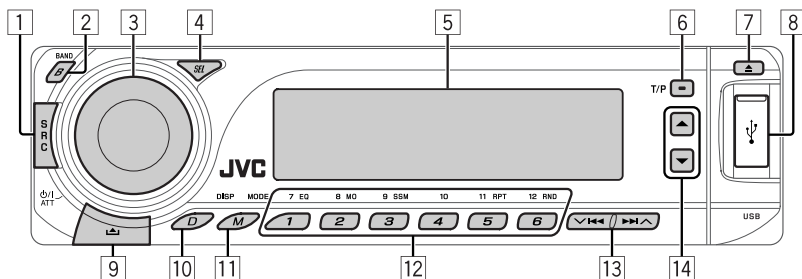

- 1 Select the source.
FM/AM → **DAB** * → **CD** * → **USB** * → **CD-CH** */
IPOD */**D.PLAYER** * (or **EXT IN**) → **BT-PHONE**
(Bluetooth Phone)* → **BT-AUDIO** (Bluetooth
Audio)* → (back to the beginning)
* You cannot select these sources if they are not
ready or not connected.
- 2 Select the bands.
- 3
 - Turn on the power.
 - Turn off the power [Hold].
 - Attenuate the sound (if the power is on).
 - Volume control [Turn].
- 4
 - Adjust the sound mode.
 - Enter the PSM settings [Hold].
- 5 Display window
- 6
 - Activate/deactivate TA Standby Reception.
 - Enter RDS programme search [Hold].
- 7 Eject disc.
- 8 USB (Universal Serial Bus) input terminal
- 9 Detach the panel.
- 10 Change the display information.
- 11 Enter functions mode.
Press M MODE, then one of the following buttons
(within 5 seconds)...
EQ : Select the sound mode.
MO : Turn on/off monaural reception.
SSM : Automatic station presetting [Hold].
RPT : Select repeat play.
RND : Select random play.
▲ / ▼ : Skip 10 tracks.
- 12
 - **FM/AM/DAB**: Select preset station/DAB service.
 - **CD/USB**: Select folder/track/disc (for CD
changer).
 - **BT-PHONE**: Select preset phone number.
- 13
 - **FM/AM/DAB**: Search for station/DAB ensemble.
 - **CD/USB**: Select track.
 - **IPOD/D.PLAYER**: Select track.
 - **BT-PHONE/BT-AUDIO**: Select setting item/
Select a registered device.
- 14
 - **DAB**: Select DAB service.
 - **CD/USB**: Select folder.
 - **IPOD/D.PLAYER**: Enter the main menu/Pause or
stop playback/Confirm selection.
 - **BT-PHONE/BT-AUDIO**: Enter setting menu/
Confirm selection.

Display window

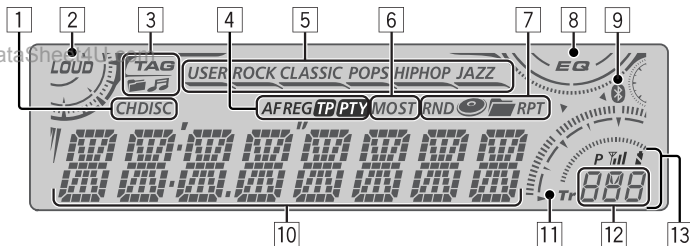

- 1 Playback source indicators
- 2 Loudness indicator
- 3 Track information indicators
- 4 RDS indicators
- 5 Sound mode indicators
 - — lights up for the selected item.
- 6 Tuner reception indicators
- 7 Playback mode/item indicators (Random/Repeat)
- 8 Equalizer indicator
- 9 Bluetooth indicator
- 10 Main display (Time, menu, playback information)
- 11 Track indicator
- 12 Source display/Preset No./Track No./Folder No./Disc No.
- 13 Status of Bluetooth device (Device number, [1 – 5]; signal strength, [0 – 3]*; battery reminder, [0 – 3]*)
* As the number increases, the signal/battery strength becomes stronger.

Using the remote controller (RM-RK50)

Installing the lithium coin battery (CR2025)

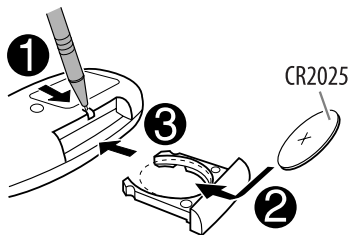

Before using the remote controller:

- Aim the remote controller directly at the remote sensor on the unit.
- DO NOT expose the remote sensor to bright light (direct sunlight or artificial lighting).

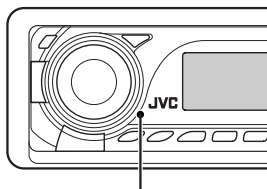

Remote sensor

Warning: To prevent accidents and damage

- Do not install any battery other than CR2025 or its equivalent.
- Do not leave the remote controller in a place (such as dashboards) exposed to direct sunlight for a long time.
- Store the battery in a place where children cannot reach.
- Do not recharge, short, disassemble, heat the battery, or dispose of it in a fire.
- Do not leave the battery with other metallic materials.
- Do not poke the battery with tweezers or similar tools.
- Wrap the battery with tape and insulate when throwing away or saving it.

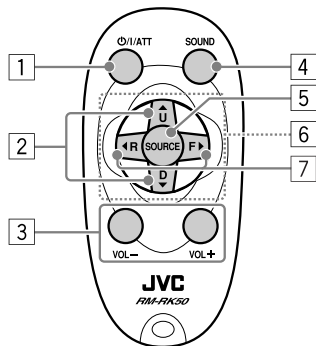

- 1 Turns the power on if pressed briefly or attenuates the sound when the power is on. Turns the power off if pressed and held.
- 2 Changes the FM/AM/DAB bands with ▲ U. Changes the preset stations (or DAB services) with D ▼. Changes the folder of the MP3/WMA/AAC/WAV.

- While playing an MP3 disc on an MP3-compatible CD changer:
 - Changes the disc if pressed briefly.
 - Changes the folder if pressed and held.
- While listening to an Apple iPod or a JVC D. player:
 - Pauses/stops or resumes playback with D ▼.
 - Enters the main menu with ▲ U. (Now ▲ U/D ▼/◀ R/F ▶ work as the menu selecting buttons.)*

- 3 Adjusts the volume level.
- 4 Selects the sound mode (iEQ: intelligent equalizer).
- 5 Selects the source.
- 6 For Bluetooth cellular phone:
 - Answers calls if pressed briefly.
 - Rejects calls if pressed and held.
- 7 Searches for stations (or DAB services) if pressed briefly.
 - Searches for DAB ensembles if pressed and held.
 - Fast-forwards or reverses the track if pressed and held.
 - Changes the tracks if pressed briefly.
- While listening to an iPod or a D. player (in menu selecting mode):
 - Selects an item if pressed briefly. (Then, press D ▼ to confirm the selection.)
 - Skips 10 items at a time if pressed and held.
 - Reverse skip/forward skip for Bluetooth audio.

- * ▲ U : Returns to the previous menu.
D ▼ : Confirms the selection.

This unit is equipped with the steering wheel remote control function.

- See the Installation/Connection Manual (separate volume) for connection.

Listening to the radio

www.DataSheet4U.com

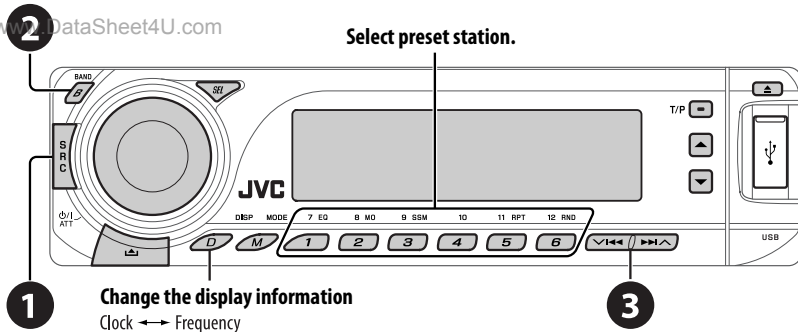

1 Select "FM/AM."

2 Select the bands.

FM1 → FM2 → FM3 → AM

3 Search for a station to listen—Auto Search.

Manual Search: Hold either one of the buttons until "M" flashes on the display, then press it repeatedly.

Lights up when receiving an FM stereo broadcast with sufficient signal strength.



When an FM stereo broadcast is hard to receive

1 MODE



2 B MO



MONO → MONO OFF (Canceled)

Reception improves, but stereo effect will be lost.

- MO indicator lights up.

FM station automatic presetting—SSM (Strong-station Sequential Memory)

You can preset up to six stations for each band.

1 BAND



FM1 → FM2 → FM3 → AM

2 MODE



3 9 SSM



[Hold]



Local FM stations with the strongest signals are searched and stored automatically in the FM band.

Manual presetting

Ex.: Storing FM station of 92.5 MHz into preset number 4 of the FM1 band.

1 BAND



FM1 → FM2 → FM3 → AM

2 < >



92.5

3 10



[Hold]

92.5



Searching for FM RDS programme — PTY Search

www.DataSheet4U.com

ENGLISH

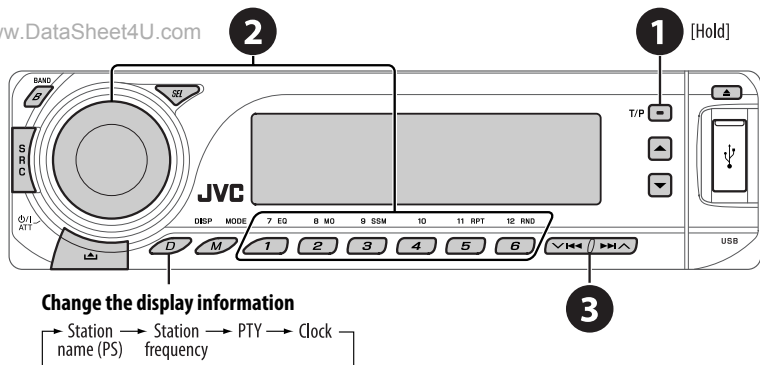

- 1 Activate PTY Search.**
- 2 Select one of the PTY codes (programme types).**
See the following for details.

3 Start searching.

If there is a station broadcasting a programme of the same PTY code as you have selected, that station is tuned in.

Storing your favorite programme types

You can store your favorite PTY codes into the number buttons.

- 1 Select a PTY code (see right column).**
- 2 Select a preset number.**



- 3 Repeat steps 1 and 2 for storing other PTY codes.**

- 4** T/P [Hold]

Preset PTY codes in the number buttons (1 to 6):



1	2	3	4	5	6
POP M	ROCK M	EASY M	CLASSICS	AFFAIRS	VARIED

PTY codes (available with the control dial):

NEWS, AFFAIRS, INFO, SPORT, EDUCATE, DRAMA, CULTURE, SCIENCE, VARIED, POP M (music), ROCK M (music), EASY M (music), LIGHT M (music), CLASSICS, OTHER M (music), WEATHER, FINANCE, CHILDREN, SOCIAL, RELIGION, PHONE IN, TRAVEL, LEISURE, JAZZ, COUNTRY, NATION M (music), OLDIES, FOLK M (music), DOCUMENT

www.DataSheet4U.com

Activating/deactivating TA/PTY Standby Reception

TA Standby Reception	Indicator	PTY Standby Reception	Indicator
Press TRP  to activate.	TP	See page 26.	PTY
The unit temporarily will switch to Traffic Announcement (TA), if available, from any source other than AM*. The volume changes to the preset TA volume level if the current level is lower than the preset level (see page 26).	Lights up	The unit temporarily will switch to your favorite PTY programme from any source other than AM*.	Lights up
Not yet activated. Tune in to another station providing the RDS signals.	Flashes	Not yet activated. Tune in to another station providing the RDS signals.	Flashes
Press TRP  to deactivate.	Goes off	Select "OFF" for the PTY code (see page 26) to deactivate.	Goes off

- When a DAB tuner is connected, TA/PTY Standby Reception also searches for services. (See also pages 20 and 26.)
- * *The unit will not switch to Traffic Announcement or PTY programme when a call connection is established through the "BT-PHONE."*

Tracing the same programme—Network-Tracking Reception

When driving in an area where FM reception is not sufficient enough, this unit automatically tunes in to another FM RDS station of the same network, possibly broadcasting the same programme with stronger signals (see the illustration on the right).

To change the Network-Tracking Reception setting, see "AF-REG" on page 26.

- When the DAB tuner is connected, refer to "Tracing the same programme—Alternative Frequency Reception" on page 20.

Programme A broadcasting on different frequency areas (01 – 05)

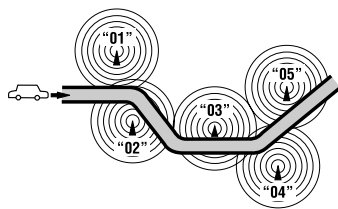

Automatic station selection—Programme Search

Usually when you press the number buttons, the preset station is tuned in.

If the signals from the FM RDS preset station are not sufficient for good reception, this unit, using the AF data, tunes in to another frequency broadcasting the same programme as the original preset station is broadcasting.

- The unit takes some time to tune in to another station using programme search.
- See also page 26.

www.DataSheet4U.com

Open the control panel and insert the disc.
Playback starts automatically.

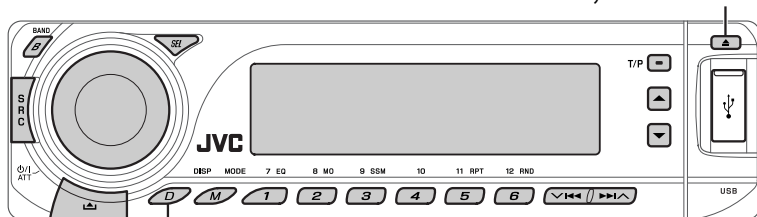

Change the display information

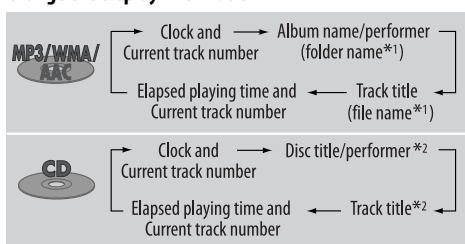

*1 If the file does not have Tag information or "TAG DISP" is set to "TAG OFF" (see page 27), folder name and file name appear. TAG indicator will not light up.

*2 "NO NAME" appears for an audio CD.

To stop play and eject the disc

- Press SRC to listen to another playback source.

Prohibiting disc ejection

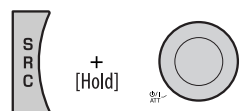

To cancel the prohibition, repeat the same procedure.

Pressing (or holding) the following buttons allows you to...







Disc type *3			(Number buttons) *4
	Press: Select track Hold: Reverse/fast-forward track	Select folder	Locate particular folder directly *5
	Press: Select track Hold: Reverse/fast-forward track	—	Locate particular track directly

*3 This unit can playback AAC files encoded using iTunes.

*4 Press to select number 1 to 6; hold to select number 7 to 12.

*5 It is required that folders be assigned with 2-digit numbers at the beginning of their folder names—01, 02, 03, and so on.

After pressing **MODE** **M**, press the following buttons to...

Disc type	 	11 RPT 	12 RND 
	Skip 10 tracks (within the same folder)	TRK RPT: Repeat current track FLDR RPT: Repeat current folder	FLDR RND: Randomly play all tracks of current folder, then tracks of next folders DISC RND: Randomly play all tracks
	Skip 10 tracks	TRK RPT: Repeat current track	DISC RND: Randomly play all tracks

- To cancel repeat play or random play, select "RPT OFF" or "RND OFF."

Listening to the USB device

MP3/WMA/AAC/WAV

You can connect a USB mass storage class device such as a USB memory, Digital Audio Player*1, portable HDD, etc. to the unit.

*1 You can connect both MTP (Media Transfer Protocol) devices and USB mass storage class devices.

Attaching a USB memory

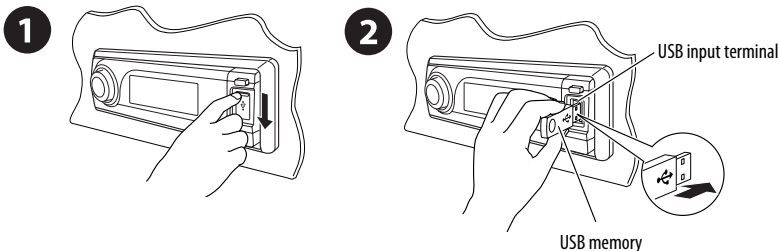

This unit can play MP3/WMA/WMA-DRM10*1/AAC*2/WAV tracks stored in a USB device.

*1 See page 32.

*2 This unit can play back AAC files encoded using iTunes. This unit cannot play back AAC files purchased from iTunes Store.

If a USB device has been attached...



Playback starts from where it has been stopped previously.

- If a different USB device is currently attached, playback starts from the beginning.

To stop play and detach the USB device

Straightly pull it out from the unit.

- Press SRC to listen to another playback source.

www.DataSheet4U.com

Cautions:

- Avoid using the USB device if it might hinder your safety driving.
- Do not pull out and attach the USB device repeatedly while "CHECK" is flashing on the display.
- Do not start the car engine if a USB device is connected.
- Stop play back before disconnecting a USB device.
- This unit may not be able to play the files depending on the type of USB device.
- You cannot connect a computer to the USB input terminal of the unit.
- Make sure all important data has been backed up to avoid losing the data.
- Do not leave a USB device in the car, expose to direct sunlight, or high temperature to avoid deformation or cause damages to the device.

Pressing (or holding) the following buttons allows you to...

	Press: Select track Hold: Reverse/fast-forward track		
	Select folder	 ... (Number buttons)	Locate particular folder directly • See also *4 and *5 on page 11.

After pressing , press the following buttons to...

	Skip 10 tracks (within the same folder)
	TRK RPT: Repeat current track FLDR RPT: Repeat all tracks of current folder
	FLDR RND: Randomly play all tracks of current folder, then tracks of next folders DISC RND: Randomly play all tracks

- To cancel repeat play or random play, select "RPT OFF" or "RND OFF."

Change the display information

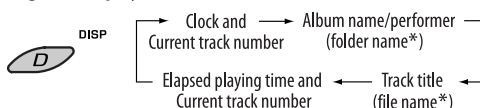

* If the file does not have Tag information or "TAG DISP" is set to "TAG OFF" (see page 27), folder name and file name appear. TAG indicator will not light up.

www.DataSheet4U.com

Using the Bluetooth® devices

For Bluetooth operations, it is required to connect the **Bluetooth Adapter** (KS-BTA200) to the CD changer jack on the rear of this unit. See also page 23.

- Refer also to the instructions supplied with the Bluetooth adapter and the Bluetooth device.
- Refer to the list (included in the box) to see the countries where you may use the Bluetooth® function.

To use a Bluetooth device through the unit ("BT-PHONE" and "BT-AUDIO") for the first time, you need to establish Bluetooth wireless connection between the unit and the device.

- Once the connection is established, it is registered in the unit even if you reset your unit. Up to five devices can be registered in total.
- Only one device can be connected at a time for each source ("BT-PHONE" and "BT-AUDIO").

Registering a Bluetooth device

Registration (Pairing) methods

Use either of the following items in the Bluetooth menu to register and establish the connection with a device.

- Select "BT-PHONE" or "BT-AUDIO" as the source to operate the Bluetooth menu.

OPEN	Make the unit ready to establish a new Bluetooth connection. Connection is established by operating the Bluetooth device.
SEARCH	Make the unit ready to establish a new Bluetooth connection. Connection is established by operating the unit.

Registering using "OPEN"

Preparation

Operate the device to turn on its Bluetooth function.

1 Select "BT-PHONE" or "BT-AUDIO."



2 Select "NEW."



3 Select "OPEN."



4 Enter a PIN (Personal Identification Number) code to the unit.

- You can enter any number you like (1-digit to 16-digit number). [Initial: 0000]
- * Some devices have their own PIN code. Enter the specified PIN code to the unit.

1 Move to the next (or previous) number position.



2 Select a number or blank space.



3 Repeat steps 1 and 2 until you finish entering a PIN code.

4 Confirm the entry.



"OPEN..." flashes on the display.

5 Use the Bluetooth device to search and connect.

On the device to be connected, enter the same PIN code you have just entered for this unit. "CONNECT" flashes on the display.

Now connection is established and you can use the device through the unit.

The device remains registered even after you disconnect the device. Use "CONNECT" (or activate "AUTO CNT") to connect the same device from next time. (See the right column and page 28.)

To search for available devices

Perform steps 1 and 2 on page 14, then...

1 Select "SEARCH."

The unit searches and displays the list of the available devices.

- If no available device is detected, "UNFOUNDED" appears.



2 Select a device you want to connect.



3 Enter the specific PIN code of the device to the unit.

- Refer to the instructions supplied with the device to check the PIN code.

4 Use the Bluetooth device to connect.

Now connection is established and you can use the device through the unit.

To connect a special device

Perform steps 1 and 2 on page 14, then...

1 Select "SPECIAL."

The unit displays the list of the preset devices.



2 Select a device you want to connect.



3 Use "OPEN" or "SEARCH" to connect.

To connect/disconnect a registered device

1 Select "BT-PHONE" or "BT-AUDIO."



2 Select a registered device you want to connect/disconnect.



3 Select "CONNECT" or "DISCONNECT" to connect/disconnect the selected device.



You can set the unit to connect a Bluetooth device automatically when the unit is turned on. (See "AUTO CNT" on page 28.)

To delete a registered device

1 Select "BT-PHONE" or "BT-AUDIO."



2 Select a registered device you want to delete.



3 Select "DELETE," then "YES" to delete the selected device.



www.DataSheet4U.com

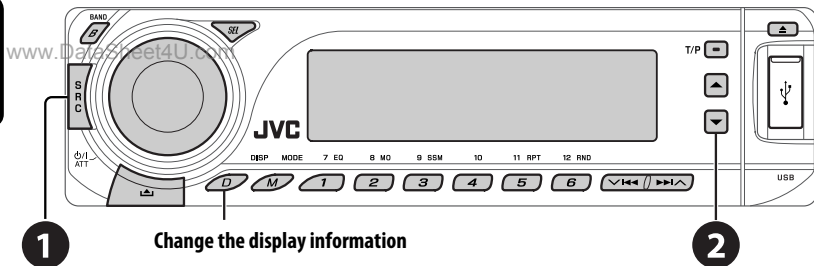

- 1 Select "BT-PHONE."
- 2 Enter Bluetooth menu.
- 3 Make a call or settings using the Bluetooth menu. (See pages 17 and 28.)

When a call comes in....

The source is automatically changed to "BT-PHONE."

When "AUTO ANS" (answer) is activated....

The unit answers the incoming calls automatically, see page 28.

- When "AUTO ANS" (answer) is deactivated, press any button (except ϕ /I ATT/control dial) to answer the incoming call.

To end the call

Hold any button (except ϕ /I ATT/control dial).

- You can adjust the microphone volume level (see page 28).







When an SMS comes in....

If the cellular phone is compatible with SMS (Short Message Service) and "MSG-INFO" (message info) is set to "AUTO" (see page 28), the unit rings and "RCV MSG" (receiving message) appears on the display to inform you the arrival of the message.

Making a call

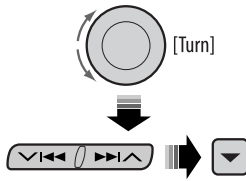
You can make a call using the following methods.

Select "BT-PHONE," then follow the following steps to make a call:

	1	2	3 (unless mentioned otherwise)
			
Call history	Display the Dial Menu.	Select a call history. REDIAL, RECEIVED, MISSED	Select a name (if it is acquired) or phone number.
Phone book		Select "PH BOOK." The list of phone number appears.	Select a name from the list.
Direct dialing		Select "NUMBER."	Enter the phone number. 
Voice command	1  [Hold]	"SAY NAME" appears on the display.	
	2 Speak the name you want to call. <ul style="list-style-type: none"> You can also use voice command from the Dial Menu. Select "VOICE" from the Dial Menu. If your cellular phone does not support the voice recognition system, "ERROR" appears on the display. 		
Preset phone number	 ... 	See the following for settings.	

Presetting the phone number

You can preset up to six phone numbers.

1 Display the Dial Menu.



2 Select "PH BOOK," "MISSED," or "RECEIVED" whichever you want to use.



3 Select a phone number.



4

 ...  [Hold]

Using the Bluetooth audio player

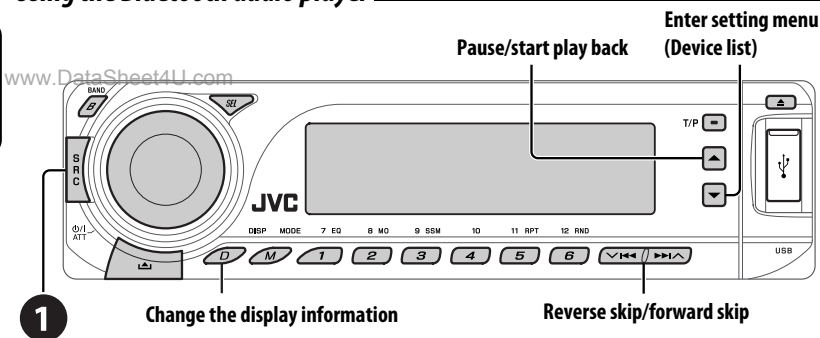

1 Select "BT-AUDIO."

If playback did not start automatically, operate the Bluetooth audio player to start playback.

- Refer also to page 15 for connecting/disconnecting/deleting a registered device.

Bluetooth Information:

If you wish to receive more information about Bluetooth, visit our JVC web site.

Listening to the CD changer

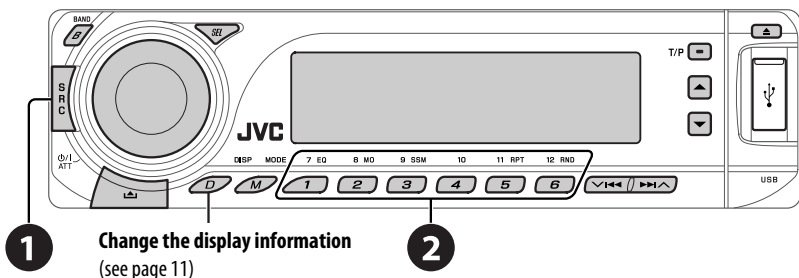

It is recommended to use a JVC MP3-compatible CD changer with your unit. You can connect a CD changer to the CD changer jack on the rear of the unit. See also page 23.

- You can only play conventional CDs (including CD Text) and MP3 discs.

Preparation

Make sure "CHANGER" is selected for the external input setting, see page 27.

1 Select "CD-CH."**2 Select a disc to start playing.**

Press: For selecting disc number 1 – 6.

Hold: For selecting disc number 7 – 12.

Pressing (or holding) the following buttons allows you to...

Disc type		
MP3	<i>Press:</i> Select track <i>Hold:</i> Reverse/fast-forward track	Select folder
CD	<i>Press:</i> Select track <i>Hold:</i> Reverse/fast-forward track	—

After pressing , press the following buttons to...

Disc type	 		
MP3	Skip 10 tracks (within the same folder)	TRK RPT: Repeat current track FLDR RPT: Repeat all tracks of current folder DISC RPT: Repeat all tracks of the current disc	FLDR RND: Randomly play all tracks of current folder, then tracks of next folders DISC RND: Randomly play all tracks of current disc MAG RND: Randomly play all tracks of the inserted discs
CD	Skip 10 tracks	TRK RPT: Repeat current track DISC RPT: Repeat all tracks of the current disc	DISC RND: Randomly play all tracks of current disc MAG RND: Randomly play all tracks of the inserted discs

- To cancel repeat play or random play, select "RPT OFF" or "RND OFF."

Listening to the DAB tuner

2 DataSheet4U.com

Select preset service.

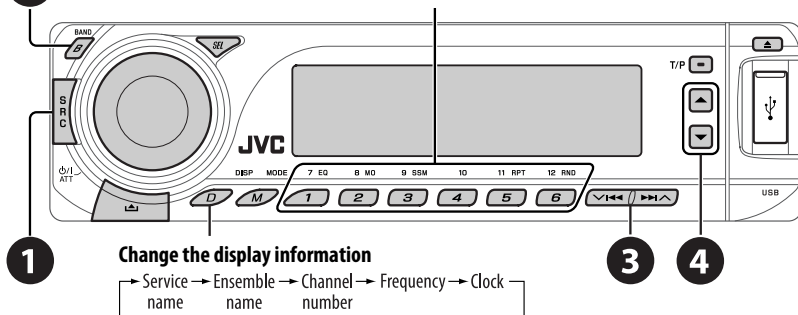

You can connect a JVC DAB tuner to the CD changer jack on the rear of the unit. See also page 23.

1 Select "DAB."

2 Select the bands.

DAB1 → DAB2 → DAB3

3 Searching for an ensemble.

Manual Search: Hold either one of the buttons until "MANU" flashes on the display, then press it repeatedly.

4 Select a service (either primary or secondary) to listen to.

Storing DAB services in memory

While listening to a DAB service...



Activating/deactivating TA/PTY Standby Reception

- Operations are exactly the same as explained on page 10 for FM RDS stations.
- You cannot store PTY codes separately for the DAB tuner and for the FM tuner.

Tracing the same programme— Alternative Frequency Reception

• **While receiving a DAB service:**

When driving in an area where a service cannot be received, this unit automatically tunes in to another ensemble or FM RDS station, broadcasting the same programme.

• **While receiving an FM RDS station:**

When driving in an area where a DAB service is broadcasting the same programme as the FM RDS station is broadcasting, this unit automatically tunes in to the DAB service.

To deactivate the Alternative Frequency Reception, see page 27.

www.DataSheet4U.com

Listening to the iPod/D. player

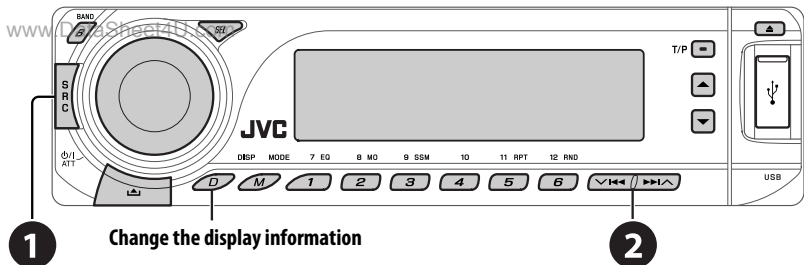

Before operating, connect either one of the following (separately purchased) to the CD changer jack on the rear of the unit. See also page 23.

- **Interface adapter for iPod**—KS-PD100 for controlling an iPod.
- **D. player interface adapter**—KS-PD500 for controlling a D. player.

Preparation

Make sure "CHANGER" is selected for the external input setting, see page 27.

- 1 Select "IPOD" or "D. PLAYER."
- 2 Select a song to start playing.

Selecting a track from the menu

1 Enter the main menu.



This mode will be canceled if no operations are done for about 5 seconds.

2 Select the desired menu.



For iPod:

PLAYLIST ↔ ARTISTS ↔ ALBUMS ↔ SONGS
↔ GENRES ↔ COMPOSER ↔ (back to the beginning)

For D. player:

PLAYLIST ↔ ARTIST ↔ ALBUM ↔ GENRE
↔ TRACK ↔ (back to the beginning)



3 Confirm the selection.



- To move back to the previous menu, press ▲.
- If a track is selected, playback starts automatically.
- Holding ▼|◀◀/▶▶|▲ can skip 10 items at a time.

	Pause/stop playback • To resume playback, press the button again.
	Press: Select tracks Hold: Reverse/fast-forward track

After pressing  , press the following buttons to...

	<p>ONE RPT: Functions the same as "Repeat One" of the iPod or "Repeat Mode → One" of the D. player.</p> <p>ALL RPT: Functions the same as "Repeat All" of the iPod or "Repeat Mode → All" of the D. player.</p>
	<p>ALBM RND*: Functions the same as "Shuffle Albums" of the iPod.</p> <p>SONG RND/RND ON: Functions the same as "Shuffle Songs" of the iPod or "Random Play → On" of the D. player.</p>

- To cancel repeat play or random play, select "RPT OFF" or "RND OFF."

* iPod: Functions only if you select "ALL" in "ALBUMS" of the main "MENU."

Listening to the other external components

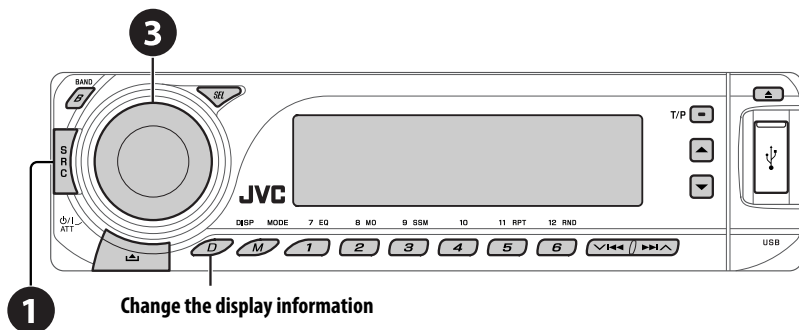

You can connect an external component using the following adapters (separately purchased) to the CD changer jack on the rear of the unit. See also page 23.

- **Line Input Adapter**—KS-U57
- **AUX Input Adapter**—KS-U58

Preparation

Make sure "EXT IN" is selected for the external input setting, see page 27.

- 1 Select "EXT IN."
- 2 Turn on the connected component and start playing the source.
- 3 Adjust the volume.
- 4 Adjust the sound as you want (see pages 24 and 25).

Concept diagram of the external device connection

For connection, see Installation/Connection manual (separate volume).

www.DataSheet4U.com

• **Connection 1 (integrated connection)**

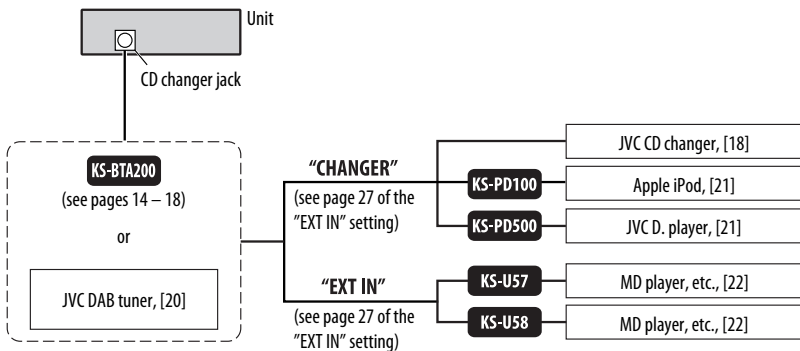

• **Connection 2 (alternative connection)**

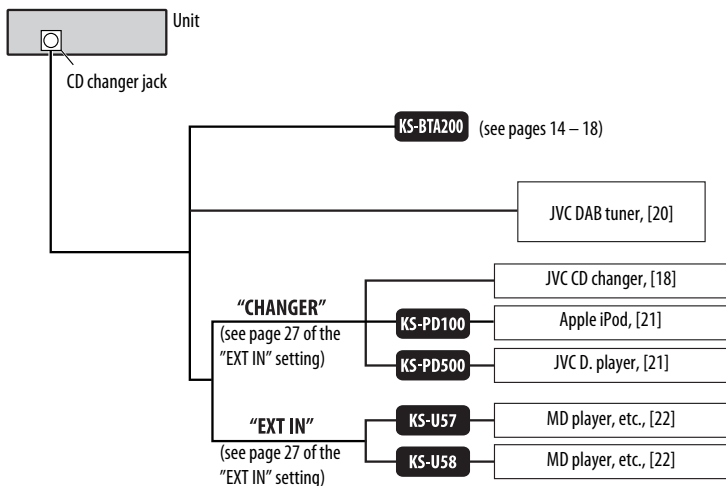

KS-XXXX : Adapter (separately purchased)

Selecting a preset sound mode

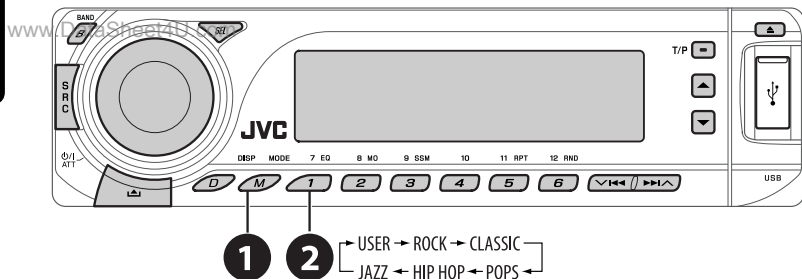

Preset values	BAS (bass)	MID (mid-range)	TRE (treble)	LOUD (loudness)
Indication (For)				
USER (Flat sound)	00	00	00	OFF
ROCK (Rock or disco music)	+03	00	+02	ON
CLASSIC (Classical music)	+01	00	+03	OFF
POPS (Light music)	+02	+01	+02	OFF
HIP HOP (Funk or rap music)	+04	-02	+01	ON
JAZZ (Jazz music)	+03	00	+03	OFF

Adjusting the sound

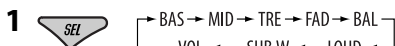

www.DataSheet4U.com

2 Adjust the level.



BAS * ¹ (bass) Adjust the bass.	-06 to +06
MID * ¹ (mid-range) Adjust the mid-range frequencies sound level.	-06 to +06
TRE * ¹ (treble) Adjust the treble.	-06 to +06
FAD * ² (fader) Adjust the front and rear speaker balance.	R06 to F06
BAL * ³ (balance) Adjust the left and right speaker balance.	L06 to R06
LOUD * ¹ (loudness) Boost low and high frequencies to produce a well-balanced sound at low volume level.	LOUD ON or LOUD OFF
SUB.W (subwoofer) Adjust the subwoofer output level.	00 to 08, initial: 04
VOL (volume) Adjust the volume.	00 to 30 (or 50) * ⁴

*¹ When you adjust the bass, mid-range, treble, or loudness, the adjustment you have made is stored for the currently selected sound mode (iEQ) including "USER."

*² If you are using a two-speaker system, set the fader level to "00."

*³ The adjustment will not affect the subwoofer output.

*⁴ Depending on the amplifier gain control setting. (See page 27 for details.)

General settings—PSM

You can change PSM (Preferred Setting Mode) items listed in the table on pages 26 and 27.

1 Enter the PSM settings.



2 Select a PSM item.



3 Select or adjust the selected PSM item.



4 Repeat steps 2 and 3 to adjust other PSM items if necessary.

5 Finish the procedure.



Indication	Item (__ : Initial)	Setting, [reference page]
DEMO Display demonstration	<ul style="list-style-type: none"> • DEMO ON • DEMO OFF 	<ul style="list-style-type: none"> : Display demonstration will be activated automatically if no operation is done for about 20 seconds, [4]. : Cancels.
CLK DISP * ¹ Clock display	<ul style="list-style-type: none"> • ON • OFF 	<ul style="list-style-type: none"> : Clock time is shown on the display at all times when the power is turned off. : Cancels; pressing D DISP will show the clock time for about 5 seconds when the power is turned off, [4].
CLOCK H Hour adjustment	0 – 23 (1 – 12)	: Initial: 0 (0:00), [4].
CLOCK M Minute adjustment	00 – 59	: Initial: 00 (0:00), [4].
24H/12H Time display mode	<ul style="list-style-type: none"> • 12H • 24H 	: See also page 4 for setting.
CLK ADJ Clock adjustment	<ul style="list-style-type: none"> • AUTO • OFF 	<ul style="list-style-type: none"> : The built-in clock is automatically adjusted using the CT (clock time) data in the RDS signal. : Cancels.
AF-REG * ² Alternative frequency/ regionalization reception	<ul style="list-style-type: none"> • AF • AF REG • OFF 	<ul style="list-style-type: none"> : When the currently received signals become weak, the unit switches to another station or service (the programme may differ from the one currently received), [10]. : When the currently received signals become weak, the unit switches to another station broadcasting the same programme. : Cancels (not selectable when "DAB AF" is set to "AF ON").
PTY-STBY PTY standby	OFF , PTY codes (see page 9)	: Activates PTY Standby Reception with one of the PTY codes, [9, 10].
TA VOL Traffic announcement volume	VOL 00 — VOL 30 or 50 * ³	: Initial: VOL 15, [10].
P-SEARCH * ² Programme search	<ul style="list-style-type: none"> • ON • OFF 	<ul style="list-style-type: none"> : Activates Programme Search, [10]. : Cancels.

*¹ If the power supply is not interrupted by turning off the ignition key of your car, it is recommended to select "OFF" to save the car's battery.

*² Only for RDS FM stations.

*³ Depending on the "AMP GAIN" setting.

Indication	Item (__ : Initial)	Setting, [reference page]
DAB AF * ⁴ Alternative frequency reception	<ul style="list-style-type: none"> • AF ON • AF OFF 	<ul style="list-style-type: none"> : Traces the programme among DAB services and FM RDS stations, [20]. : Cancels.
DAB VOL * ⁴ DAB volume adjustment	<ul style="list-style-type: none"> VOL –12 — VOL +12 	<ul style="list-style-type: none"> : Initial: VOL 00; You can adjust the volume level of DAB tuner to match the FM sound level and store it in memory.
DIMMER Dimmer	<ul style="list-style-type: none"> • AUTO • ON • OFF 	<ul style="list-style-type: none"> : Dims the display when you turn on the headlights. : Dims the display illumination. : Cancels.
TEL Telephone muting	<ul style="list-style-type: none"> • MUTING 1/ MUTING 2 • OFF 	<ul style="list-style-type: none"> : Select either one which mutes the sounds while using a cellular phone. : Cancels.
SCROLL * ⁵ Scroll	<ul style="list-style-type: none"> • ONCE • AUTO • OFF 	<ul style="list-style-type: none"> : Scrolls the track information once. : Repeats scrolling (at 5-second intervals). : Cancels. (Holding D DISP can scroll the display regardless of the setting.)
WOOFER Subwoofer cutoff frequency	<ul style="list-style-type: none"> • LOW • MID • HIGH 	<ul style="list-style-type: none"> : Frequencies lower than 90 Hz are sent to the subwoofer. : Frequencies lower than 135 Hz are sent to the subwoofer. : Frequencies lower than 180 Hz are sent to the subwoofer.
EXT IN * ⁶ External input	<ul style="list-style-type: none"> • CHANGER • EXT IN 	<ul style="list-style-type: none"> : To use a JVC CD changer, [18], or an Apple iPod/a JVC D. player, [21]. : To use any other external component, [22].
TAG DISP Tag display	<ul style="list-style-type: none"> • TAG ON • TAG OFF 	<ul style="list-style-type: none"> : Shows the tag while playing MP3/WMA/AAC/WAV tracks. : Cancels.
AMP GAIN Amplifier gain control	<ul style="list-style-type: none"> • LOW PWR • HIGH PWR 	<ul style="list-style-type: none"> : VOL 00 – VOL 30 (Select if the maximum power of each speaker is less than 50 W to prevent damaging the speaker.) : VOL 00 – VOL 50
IF BAND Intermediate frequency band	<ul style="list-style-type: none"> • AUTO • WIDE 	<ul style="list-style-type: none"> : Increases the tuner selectivity to reduce interference noises between adjacent stations. (Stereo effect may be lost.) : Subject to interference noises from adjacent stations, but sound quality will not be degraded and the stereo effect will remain.

*⁴ Displayed only when DAB tuner is connected.

*⁵ Some characters or symbols will not be shown correctly (or will be blanked) on the display.

*⁶ Displayed only when one of the following sources is selected—FM, AM, DAB, CD, USB, or Bluetooth.

Bluetooth settings

You can change the settings listed on the right column according to your preference.

1 Select "BT-PHONE" or "BT-AUDIO."



2 Enter the Bluetooth menu.



3 Select "SETTING."



4 Select a setting item.



5 Change the setting accordingly.



Setting menu (___: Initial)

■ AUTO CNT (connect)

When the unit is turned on, the connection is established automatically with....

OFF: No Bluetooth device.

LAST: The last connected Bluetooth device.

ORDER: The available registered Bluetooth device found at first.

■ AUTO ANS (answer)

Only for the device being connected for "BT-PHONE."

ON: The unit answers the incoming calls automatically.

OFF: The unit does not answer the calls automatically. Answer the calls manually.

REJECT: The unit rejects all incoming calls.

■ MSG-INFO (message info)

Only for the device being connected for "BT-PHONE."

AUTO: The unit informs you of the arrival of a message by ringing and displaying "RCV MSG" (receiving message).

MANUAL: The unit does not inform you of the arrival of a message.

■ MIC SET (microphone setting)

Only for the device being connected for "BT-PHONE."

Adjust microphone volume connected to the Bluetooth adapter, [LEVEL 01/02/03].

■ VERSION

The Bluetooth software and hardware versions are shown.

Maintenance

How to clean the connectors

Frequent detachment will deteriorate the connectors. To minimize this possibility, periodically wipe the connectors with a cotton swab or cloth moistened with alcohol, being careful not to damage the connectors.

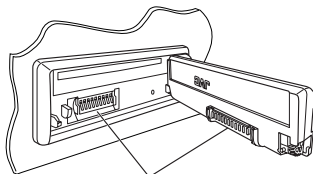

Connector

Moisture condensation

Moisture may condense on the lens inside the unit in the following cases:

- After starting the heater in the car.
- If it becomes very humid inside the car.

Should this occur, the unit may malfunction. In this case, eject the disc and leave the unit turned on for a few hours until the moisture evaporates.

How to handle discs

When removing a disc from its case, press down the center holder of the case and lift the disc out, holding it by the edges.

Center holder



- Always hold the disc by the edges. Do not touch its recording surface.

When storing a disc into its case, gently insert the disc around the center holder (with the printed surface facing up).

- Make sure to store discs into the cases after use.

To keep discs clean

A dirty disc may not play correctly. If a disc does become dirty, wipe it with a soft cloth in a straight line from center to edge.



- Do not use any solvent (for example, conventional record cleaner, spray, thinner, benzene, etc.) to clean discs.

To play new discs

New discs may have some rough spots around the inner and outer edges. If such a disc is used, this unit may reject the disc.



To remove these rough spots, rub the edges with a pencil or ball-point pen, etc.

Do not use the following discs:

Warped disc



Sticker



Sticker residue



Stick-on label



Unusual shape



Single CD (8 cm disc)

More about this unit

General

www.DataSheet4U.com

Turning on the power

- By pressing SRC on the unit, you can also turn on the power. If the source is ready, playback also starts.

Turning off the power

- If you turn off the power while listening to a disc, disc play will start from where playback has been stopped previously, next time you turn on the power.

FM/AM/RDS

Storing stations in memory

- During SSM search...
 - Received stations are preset in No. 1 (lowest frequency) to No. 6 (highest frequency).
 - When SSM is over, the station stored in No. 1 will be automatically tuned in.
- When storing stations, the previously preset stations are erased and stations are stored newly.

FM RDS operations

- Network-Tracking Reception requires two types of RDS signals—PI (Programme Identification) and AF (Alternative Frequency) to work correctly. Without receiving these data correctly, Network-Tracking Reception will not operate correctly.
- If a Traffic Announcement is received by TA Standby Reception, the volume level automatically changes to the preset level (TA VOL) if the current level is lower than the preset level.
- When Alternative Frequency Reception is activated (with AF selected), Network-Tracking Reception is also activated automatically. On the other hand, Network-Tracking Reception cannot be deactivated without deactivating Alternative Frequency Reception. (See pages 26 and 27.)
- If you want to know more about RDS, visit <<http://www.rds.org.uk>>.

Disc

Caution for DualDisc playback

- The Non-DVD side of a “DualDisc” does not comply with the “Compact Disc Digital Audio” standard. Therefore, the use of Non-DVD side of a DualDisc on this product may not be recommended.

General

- This unit has been designed to reproduce CDs/CD Texts, and CD-Rs (Recordable)/CD-RWs (Rewritable) in audio CD (CD-DA), MP3/WMA/AAC formats.
- When a disc is inserted upside down, “PLEASE” and “EJECT” appear alternately on the display. Press ▲ to eject the disc.
- While fast-forwarding or reversing on an MP3/WMA/AAC disc, you can only hear intermittent sounds.

Ejecting a disc

- If the ejected disc is not removed within 15 seconds, the disc is automatically inserted again into the loading slot to protect it from dust. Playback starts automatically.
- After ejecting a disc, “NO DISC” appears and you cannot operate some of the buttons. Insert another disc or press SRC to select another playback source.

Playing a CD-R or CD-RW

- Use only “finalized” CD-Rs or CD-RWs.
- This unit can play back only files of the same type which are first detected if a disc includes both audio CD (CD-DA) files and MP3/WMA/AAC files.
- This unit can play back multi-session discs; however, unclosed sessions will be skipped while playing.
- Some CD-Rs or CD-RWs may not play back on this unit because of their disc characteristics, or for the following reasons:

- Discs are dirty or scratched.
 - Moisture condensation occurs on the lens inside the unit.
 - The pickup lens inside the unit is dirty.
 - CD-R/CD-RW on which the files are written with “Packet Write” method.
 - There are improper recording conditions (missing data, etc.) or media conditions (stained, scratched, warped, etc.).
 - CD-RWs may require a longer readout time since the reflectance of CD-RWs is lower than that of regular CDs.
 - Do not use the following CD-Rs or CD-RWs:
 - Discs with stickers, labels, or a protective seal stuck to the surface.
 - Discs on which labels can be directly printed by an ink jet printer.
- Using these discs under high temperatures or high humidities may cause malfunctions or damage to the unit.

Playing an MP3/WMA/AAC disc

- This unit can play back MP3/WMA/AAC files with the extension code <.mp3>, <.wma>, or <.m4a> (regardless of the letter case—upper/lower).
- This unit can show the names of albums, artists (performer), ID3 Tag (Version 1.0, 1.1, 2.2, 2.3, or 2.4) for MP3, and show WMA/AAC Tag.
- This unit can display only one-byte characters. No other characters can be correctly displayed.
- This unit can play back MP3/WMA/AAC files meeting the conditions below:
 - Bit rate of MP3: 8 kbps — 320 kbps
 - Sampling frequency of MP3:
 - 48 kHz, 44.1 kHz, 32 kHz (for MPEG-1)
 - 24 kHz, 22.05 kHz, 16 kHz (for MPEG-2)
 - 12 kHz, 11.025 kHz, 8 kHz (for MPEG-2.5)
 - Bit rate of WMA: 16 kbps — 32 kbps
 - (Sampling frequency: 22.05 kHz)
 - 32 kbps — 320 kbps
 - (Sampling frequency: 48 kHz, 44.1 kHz, 32 kHz)
- Bit rate of AAC: 16 kbps — 320 kbps
- Sampling frequency of AAC: 48 kHz, 44.1 kHz
- Disc format: ISO 9660 Level 1/Level 2, Romeo, Joliet, Windows long file name
- The maximum number of characters for file/folder names vary among the disc format used (includes 4 extension characters—<.mp3>, <.wma>, or <.m4a>).
 - ISO 9660 Level 1: up to 12 characters
 - ISO 9660 Level 2: up to 31 characters
 - Romeo*: up to 128 (60) characters
 - Joliet*: up to 64 (30) characters
 - Windows long file name*: up to 128 (60) characters
- * *The parenthetic figure is the maximum number of characters for file/folder names in case the total number of files and folders is 271 or more.*
- This unit can recognize a total of 512 files, of 200 folders, and of 8 hierarchies.
- This unit can play back files recorded in VBR (variable bit rate).
 - Files recorded in VBR have a discrepancy in elapsed time display, and do not show the actual elapsed time. Especially, after performing the search function, this difference becomes noticeable.
- This unit cannot play back the following files:
 - MP3 files encoded with MP3i and MP3 PRO format.
 - MP3 files encoded in an inappropriate format.
 - MP3 files encoded with Layer 1/2.
 - WMA files encoded with lossless, professional, and voice format.
 - WMA files which are not based upon Windows Media® Audio.
 - WMA files copy-protected with DRM.
 - AAC files created by any other application than iTunes.
 - AAC files encoded with Apple lossless format.
 - Files which have the data such as AIFF, ATRAC3, etc.
- The search function works but search speed is not constant.

Playing MP3/WMA/AAC/WAV tracks from a USB device

- Connecting a USB device automatically changes the source to "USB".
- While playing from a USB device, the playback order may differ from other players.
- This unit may be unable to play back some USB devices or some files due to their characteristics or recording conditions.
- Depending on the shape of the USB devices and connection ports, some USB devices may not be attached properly or the connection might be loose.
- When connecting a USB mass storage class device, refer also to its instructions.
- Connect one USB mass storage class device to the unit at a time. Do not use a USB hub.
- You can connect two types of USB device to this unit—MTP device and Mass storage class device. If you connect an MTP device featuring "USB digital media streaming" to this unit (except JVC D. Player XA-HD500), you can play back the WMA-DRM10 (Digital Right Management) files purchased through the music distributing web sites, through this unit.
- This unit is compatible with the USB Full-Speed.
- If the connected USB device does not have the correct files, "NO FILE" appears.
- This unit can show ID3 Tag (Version 1.0, 1.1, 2.2, 2.3, or 2.4) for MP3 and show WMA/AAC/WAV Tag.
- This unit can play back MP3/WMA/AAC/WAV files meeting the conditions below:

MP3:

- Bit rate: 8 kbps — 320 kbps
- Sampling frequency: 48 kHz, 44.1 kHz, 32 kHz (for MPEG-1) 24 kHz, 22.05 kHz, 16 kHz (for MPEG-2)

WMA:

- Bit rate: 5 kbps — 320 kbps
- Sampling frequency: 8 kHz — 48 kHz
- Channel: Mono/stereo

AAC:

- Bit rate: 16 kbps — 320 kbps
- Sampling frequency: 48 kHz — 44.1 kHz
- Channel: 1 ch/2 ch

WAV:

- Bit rate: Linear PCM at 705 kbps and 1 411 kbps
- Sampling frequency: 44.1 kHz
- Channel: 1 ch/2 ch
- This unit can play back MP3 files recorded in VBR (variable bit rate).
- The maximum number of characters for folder and file names is 25 characters; 128 characters for MP3/WMA/AAC/WAV Tag.
- This unit can recognize a total of 50 000 files and 5 000 folders (999 files per folder). However, the display can show until 9 999 folders/files.
- The unit cannot recognize a USB mass storage class device whose rating is other than 5 V and does not exceed 500 mA.
- This unit may not recognize a USB device connected through a USB card reader.
- This unit may not play back files in a USB device properly when using a USB extension cord.
- This unit cannot assure proper functions or supply power to all types of USB devices.
- This unit cannot play back the following files:
 - MP3 files encoded with MP3i and MP3 PRO format.
 - MP3 files encoded in an inappropriate format.
 - MP3 files encoded with Layer 1/2.
 - WMA files encoded with lossless, professional, and voice format.
 - WMA files which are not based upon Windows Media® Audio.
 - AAC files created by any other application than iTunes.
 - AAC files encoded with Apple lossless format.
 - WAV files encoded using MS-ADPCM.
 - Files which have the data such as AIFF, ATRAC3, etc.

Changing the source

- If you change the source, playback also stops. Next time you select the same source again, playback starts from where it has been stopped previously.

Detaching a USB device

- After removing a USB device, "NO USB" appears and you cannot operate some of the buttons. Reattach a USB device or press SRC to select another playback source.

Bluetooth operations

General

- While driving, do not perform complicated operation such as dialing the numbers, using phone book, etc. When you perform these operations, stop your car in a safe place.
- Some Bluetooth devices may not be connected to this unit depending on the Bluetooth version of the device.
- This unit may not work for some Bluetooth devices.
- Connecting condition may vary depending on the circumstances around you.
- When the unit is turned off, the device is disconnected.

Warning messages for Bluetooth operations

ERR CNCT (Error Connection)	The device is registered but the connection has failed. Use "CONNECT" to connect the device again. (See page 15.)
ERROR	Try the operation again. If "ERROR" appears again, check if the device supports the function you have tried.
UNFOUND	No available Bluetooth device is detected by "SEARCH."
LOADING	The unit is updating the phone book and/or text messages.
WAIT	The unit is preparing to use the Bluetooth function. If the message does not disappear, turn off and turn on the unit, then connect the device again (or reset the unit).
RESET 8	Check the connection between the adapter and this unit.

DAB

- Only the primary DAB service can be preset even when you store a secondary service.
- A previously preset DAB service is erased when a new DAB service is stored in the same preset number.

iPod or D. player

- When you turn on this unit, the iPod or D. player is charged through this unit.
- While the iPod or D. player is connected, all operations from the iPod or D. player are disabled. Perform all operations from this unit.
- The text information may not be displayed correctly.
- If the text information includes more than 8 characters, it scrolls on the display. This unit can display up to 40 characters.

Notice:

When operating an iPod or a D. player, some operations may not be performed correctly or as intended. In this case, visit the following JVC web site:

For iPod users: <<http://www.jvc.co.jp/english/car/support/ks-pd100/index.html>>

For D. player users: <<http://www.jvc.co.jp/english/car/support/ks-pd500/index.html>>

General settings—PSM

- "AUTO" setting for "DIMMER" may not work correctly on some vehicles, particularly on those having a control dial for dimming. In this case, change the "DIMMER" setting to any other than "AUTO."
- If you change the "AMP GAIN" setting from "HIGH PWR" to "LOW PWR" while the volume level is set higher than "VOL 30," the unit automatically changes the volume level to "VOL 30."

Troubleshooting

What appears to be trouble is not always serious. Check the following points before calling a service center.
www.DataSheet4U.com

	Symptom	Remedy/Cause
General	• Sound cannot be heard from the speakers.	<ul style="list-style-type: none"> • Adjust the volume to the optimum level. • Check the cords and connections.
	• The unit does not work at all.	Reset the unit (see page 2).
FM/AM	• SSM automatic presetting does not work.	Store stations manually.
	• Static noise while listening to the radio.	Connect the aerial firmly.
Discs in general	• Disc cannot be played back.	Insert the disc correctly.
	<ul style="list-style-type: none"> • CD-R/CD-RW cannot be played back. • Tracks on the CD-R/CD-RW cannot be skipped. 	<ul style="list-style-type: none"> • Insert a finalized CD-R/CD-RW. • Finalize the CD-R/CD-RW with the component which you used for recording.
	• Disc can neither be played back nor ejected.	<ul style="list-style-type: none"> • Unlock the disc (see page 11). • Eject the disc forcibly (see page 2).
	• Disc sound is sometimes interrupted.	<ul style="list-style-type: none"> • Stop playback while driving on rough roads. • Change the disc. • Check the cords and connections.
	• "NO DISC" appears on the display.	Insert a playable disc into the loading slot.
	• "PLEASE" and "EJECT" appear alternately on the display.	This occurs sometimes due to over-heating. Eject the disc or change to another playback source.
MP3/WMA/AAC	• Disc cannot be played back.	<ul style="list-style-type: none"> • Use a disc with MP3/WMA/AAC tracks recorded in the format compliant with ISO 9660 Level 1, Level 2, Romeo, or Joliet. • Add the extension code <.mp3>, <.wma>, or <.m4a> to the file names.
	• Noise is generated.	Skip to another track or change the disc. (Do not add the extension code <.mp3>, <.wma>, or <.m4a> to non-MP3/WMA/AAC tracks.)
	• A longer readout time is required ("CHECK" keeps flashing on the display).	Do not use too many hierarchies and folders.

	Symptom	Remedy/Cause
MP3/WMA/AAC	• Tracks do not play back in the order you have intended them to play.	Playback order is determined when files are recorded.
	• Elapsed playing time is not correct.	This sometimes occurs during play. This is caused by how the tracks are recorded on the disc.
	• "PLEASE" and "EJECT" appear alternately on the display.	Insert a disc that contains MP3/WMA/AAC tracks.
	• Correct characters are not displayed (e.g. album name).	This unit can only display letters (upper case), numbers, and a limited number of symbols.
USB device	• Noise is generated.	The track played back is not an MP3/WMA/AAC/WAV track. Skip to another file. (Do not add the extension code <.mp3>, <.wma>, <.m4a>, or <.wav> to non-MP3/WMA/AAC/WAV tracks.)
	• "CHECK" keeps flashing on the display.	<ul style="list-style-type: none"> • Readout time varies depending on the USB device. • Do not use too many hierarchy, folders, and empty folders*. • Turn off the power then on again. <p>* Folder that is physically empty or folder that contains data but does not contain valid MP3/WMA/AAC/WAV track.</p>
	• "NO FILE" flashes on the display.	Attach a USB device that contains tracks encoded in an appropriate format.
	• "NO USB" appears on the display.	
	• "READ" and "FAILED" appear alternately on the display.	The total number of tracks could not be accessed properly.
	• Correct characters are not displayed (e.g. album name).	This unit can only display letters (upper case), numbers, and a limited number of symbols.
	• While playing a track, sound is sometimes interrupted.	MP3/WMA/AAC/WAV tracks have not been properly copied into the USB device. Copy MP3/WMA/AAC/WAV tracks again into the USB device, and try again.

	Symptom	Remedy/Cause
Bluetooth*	<ul style="list-style-type: none"> Bluetooth device does not detect the unit. 	The unit can be connected with one Bluetooth cellular phone and one Bluetooth audio device at a time. While connecting a device, this unit cannot be detected from another device. Disconnect currently connected device and search again.
	<ul style="list-style-type: none"> The unit does not detect the Bluetooth device. 	<ul style="list-style-type: none"> Check the Bluetooth setting of the device. Search from the Bluetooth device. After the device detects the unit, select "OPEN" on the unit to connect the device. (See page 14.)
	<ul style="list-style-type: none"> The unit does not make pairing with the Bluetooth device. 	<ul style="list-style-type: none"> Enter the same PIN code for both the unit and target device. Select the device name from "SPECIAL," then try to connect again. (See page 15.)
	<ul style="list-style-type: none"> Echo or noise occurs. 	Adjust the microphone unit position.
	<ul style="list-style-type: none"> Phone sound quality is poor. 	<ul style="list-style-type: none"> Reduce the distance between the unit and the Bluetooth audio device. Move the car to a place where you can get a better signal reception.
	<ul style="list-style-type: none"> The sound is interrupted or skipped during playback of a Bluetooth audio device. 	<ul style="list-style-type: none"> Reduce the distance between the unit and the Bluetooth audio device. Disconnect the device connected for "BT-PHONE." Turn off, then turn on the unit. (When the sound is not yet restored,) connect the device again.
	<ul style="list-style-type: none"> The connected audio device cannot be controlled. 	Check whether the connected audio device supports AVRC (Audio Video Remote Control Profile).
CD changer	<ul style="list-style-type: none"> "NO DISC" appears on the display. 	Insert a disc into the magazine.
	<ul style="list-style-type: none"> "NO MAG" appears on the display. 	Insert the magazine.
	<ul style="list-style-type: none"> "RESET 8" appears on the display. 	Connect this unit and the CD changer correctly and press the reset button of the CD changer.
	<ul style="list-style-type: none"> "RESET 1" – "RESET 7" appears on the display. 	Press the reset button of the CD changer.
	<ul style="list-style-type: none"> The CD changer does not work at all. 	Reset the unit (see page 2).

* For Bluetooth operations, refer also to the instructions supplied with the Bluetooth Adapter.

	Symptom	Remedy/Cause
DAB	• “noSIGNAL” appears on the display.	Move to an area with stronger signals.
	• “RESET 08” appears on the display.	Connect this unit and the DAB tuner correctly and reset the unit (see page 2).
	• The DAB tuner does not work at all.	Reconnect this unit and the DAB tuner correctly. Then, reset the unit (see page 2).
	• “ANTENANG” appears on the display.	Check the cords and connections.
iPod/D. player	• The iPod or D. player does not turn on or does not work.	<ul style="list-style-type: none"> • Check the connecting cable and its connection. • Update the firmware version. • Charge the battery.
	• The sound is distorted.	Deactivate the equalizer either on this unit or the iPod/D. player.
	• “NO IPOD” or “NO DP” appears on the display.	<ul style="list-style-type: none"> • Check the connecting cable and its connection. • Charge the battery.
	• Playback stops.	The headphones are disconnected during playback. Restart the playback operation (see page 21).
	• No sound can be heard when connecting an iPod nano.	<ul style="list-style-type: none"> • Disconnect the headphones from the iPod nano. • Update the firmware version of the iPod nano.
	• No sound can be heard.	Disconnect the adapter from the D. player. Then, connect it again.
	• “ERROR 01” appears on the display when connecting a D. player.	
	• “NO FILE” or “NO TRACK” appears on the display.	No tracks are stored. Import tracks to the iPod or D. player.
	• “RESET 1” – “RESET 7” appears on the display.	Disconnect the adapter from both the unit and iPod/D. player. Then, connect it again.
	• “RESET 8” appears on the display.	Check the connection between the adapter and this unit.
• The iPod’s or D. player’s controls do not work after disconnecting from this unit.	Reset the iPod or D. player.	

- Microsoft and Windows Media are either registered trademarks or trademarks of Microsoft Corporation in the United States and/or other countries.
- iPod is a trademark of Apple Computer, Inc., registered in the U.S. and other countries.
- The Bluetooth word mark and logos are owned by the Bluetooth SIG, Inc. and any use of such marks by Victor Company of Japan, Limited (JVC) is under license. Other trademarks and trade names are those of their respective owners.

Specifications

AUDIO AMPLIFIER SECTION		
Maximum Power Output:	Front and rear:	50 W per channel
Continuous Power Output (RMS):	Front and rear:	19 W per channel into 4 Ω , 40 Hz to 20 000 Hz at no more than 0.8% total harmonic distortion.
Load Impedance:		4 Ω (4 Ω to 8 Ω allowance)
Tone Control Range:	Bass:	± 12 dB at 60 Hz
	Mid-range:	± 12 dB at 1 kHz
	Treble:	± 12 dB at 10 kHz
Frequency Response:		40 Hz to 20 000 Hz
Signal-to-Noise Ratio:		70 dB
Line-Out Level/Impedance:		2.5 V/20 k Ω load (full scale)
Output Impedance:		1 k Ω
Subwoofer-Out Level/Impedance:		2.5 V/20 k Ω load (full scale)
Other Terminal:		CD changer, USB input terminal, steering wheel remote input

TUNER SECTION		
Frequency Range:	FM:	87.5 MHz to 108.0 MHz
	AM:	(MW) 522 kHz to 1 620 kHz (LW) 144 kHz to 279 kHz
FM Tuner		
Usable Sensitivity:		11.3 dBf (1.0 μ V/75 Ω)
50 dB Quieting Sensitivity:		16.3 dBf (1.8 μ V/75 Ω)
Alternate Channel Selectivity (400 kHz):		65 dB
Frequency Response:		40 Hz to 15 000 Hz
Stereo Separation:		30 dB
MW Tuner		
Sensitivity:		20 μ V
Selectivity:		35 dB
LW Tuner		
Sensitivity:		50 μ V

CD PLAYER SECTION	
Type:	Compact disc player
Signal Detection System:	Non-contact optical pickup (semiconductor laser)
Number of Channels:	2 channels (stereo)
Frequency Response:	5 Hz to 20 000 Hz
Dynamic Range:	96 dB
Signal-to-Noise Ratio	98 dB
Wow and Flutter:	Less than measurable limit
MP3 Decoding Format: (MPEG1/2 Audio Layer 3)	Max. Bit Rate: 320 kbps
WMA (Windows Media® Audio) Decoding Format:	Max. Bit Rate: 320 kbps
AAC (Advanced Audio Coding) Decoding Format:	Max. Bit Rate: 320 kbps

USB SECTION		
USB Standard:	USB 1.1	
Data Transfer Rate:	Full Speed:	Max. 12 Mbytes
	Low Speed:	Max. 1.5 Mbytes
Compatible Device:	Mass storage class, MTP	
Compatible File System:	FAT 12/16/32	
Playable Audio Format:	MP3/WMA/AAC/WAV	
Max. Current:	500 mA	

GENERAL		
Power Requirement:	Operating Voltage:	DC 14.4 V (11 V to 16 V allowance)
Grounding System:		Negative ground
Allowable Operating Temperature:		0°C to +40°C
Dimensions (W × H × D): (approx.)	Installation Size:	182 mm × 52 mm × 158 mm
	Panel Size:	188 mm × 58 mm × 12 mm
Mass:		1.4 kg (excluding accessories)

Design and specifications are subject to change without notice.

Having TROUBLE with operation?

www.DataSheet4U.com

Please reset your unit

Refer to page of How to reset your unit

Dear Customer,

This apparatus is in conformance with the valid European directives and standards regarding electromagnetic compatibility and electrical safety.

European representative of Victor Company of Japan, Limited
is:

JVC Technology Centre Europe GmbH

Postfach 10 05 52

61145 Friedberg

Germany

JVC



EN, FR

© 2007 Victor Company of Japan, Limited

www.DataSheet4U.com

0107DTSMDTJEIN