

KENWOOD

CD-RECEIVER

KDC-MP443

KDC-MP3043

KDC-MP343

KDC-MP243

KDC-MP243SW

INSTRUCTION MANUAL

Kenwood Corporation



Contents

Before use	3	Appendix	14
Basic Operation	4	Accessories/ Installation Procedure	16
General functions		Connecting Wires to Terminals	17
Tuner functions		Installation	18
Disc play functions		Troubleshooting Guide	19
General Operation	6	Specifications	20
Audio Control			
Audio Setup			
Speaker Setting			
Switching Display			
Manual Clock Adjustment			
Tuner Operation	8		
Frequency Step Setting			
Music disc/Audio file Operation	9		
Direct Music Search			
Direct Disc Search			
Music Search (Function of Audio file)			
Music Search (Function of Music CD)			
Menu Operation	10		
Menu System			
Activating Security Code			
Deactivating Security Code			
Auxiliary Input Display Setting			
Demonstration mode Setting			
Basic Operations of remote control	13		

Before use

⚠ WARNING

To prevent injury or fire, take the following precautions:

- To prevent a short circuit, never put or leave any metallic objects (such as coins or metal tools) inside the unit.

Before using this unit for the first time

This unit is initially set on the Demonstration mode. When using this unit for the first time, cancel the <Demonstration mode Setting> (page 12).

How to reset your unit

- If the unit fails to operate properly, press the Reset button. The unit returns to factory settings when the Reset button is pressed.
- Press the reset button if the disc auto changer fails to operate correctly. Normal operation should be restored.

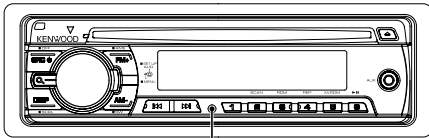

Reset button

Cleaning the Unit

If the faceplate of this unit is stained, wipe it with a dry soft cloth such as a silicon cloth. If the faceplate is stained badly, wipe the stain off with a cloth moistened with neutral cleaner, then wipe it again with a clean soft dry cloth.



- Applying spray cleaner directly to the unit may affect its mechanical parts. Wiping the faceplate with a hard cloth or using a volatile liquid such as thinner or alcohol may scratch the surface or erases characters.

Cleaning the Faceplate Terminals

If the terminals on the unit or faceplate get dirty, wipe them with a clean soft dry cloth.

Lens Fogging

When you turn on the car heater in cold weather, dew or condensation may form on the lens in the CD player of the unit. Called lens fogging, this condensation on the lens may not allow CDs to play. In such a situation, remove the disc and wait for the condensation to evaporate. If the unit still does not operate normally after a while, consult your Kenwood dealer.

- If you experience problems during installation, consult your Kenwood dealer.
- When you purchase optional accessories, check with your Kenwood dealer to make sure that they work with your model and in your area.
- The characters which can be displayed by this unit are A-Z 0-9 @ " ' ` % & * + - = , . / \ < > [] () ; : ^ - { } ~ .
- The illustrations of the display and the panel appearing in this manual are examples used to explain more clearly how the controls are used. Therefore, what appears on the display in the illustrations may differ from what appears on the display on the actual equipment, and some of the illustrations on the display may be inapplicable.

Handling CDs

- Do not touch the recording surface of the CD.
- Do not stick tape etc. on the CD, or use a CD with tape stuck on it.
- Do not use disc type accessories.
- Clean from the center of the disc and move outward.
- When removing CDs from this unit, pull them out horizontally.
- If the CD center hole or outside rim has burrs, use the CD only after removing the burrs with a ballpoint pen etc.

CDs that cannot be used

- CDs that are not round cannot be used.

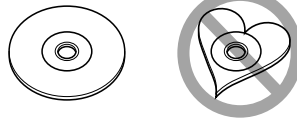

- CDs with coloring on the recording surface or CDs that are dirty cannot be used.

- This unit can only play the CDs with 

This unit may not correctly play discs which do not have the mark.

- You cannot play a CD-R or CD-RW that has not been finalized. (For the finalization process refer to your CD-R/CD-RW writing software, and your CD-R/CD-RW recorder instruction manual.)

Basic Operation

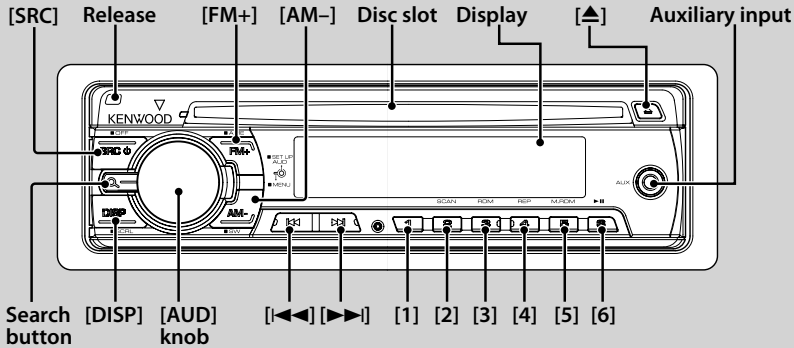

General functions

Power/Source select button: [SRC]

Turns on the power.

When the power is on, the source switches between Tuner ("TUNER"), CD ("CD"), Auxiliary input ("AUX"), and Standby ("STANDBY") each time this button is pressed.

Press at least 1 second to turn off the power.



- When an optional accessory is connected, the source name for each device appears (KDC-MP443 only).

Volume control: [AUD] knob

Turn the knob to adjust the volume.

Faceplate release: Release

Releases the faceplate lock so that it can be removed. Refer to the following diagram when reattaching the faceplate.

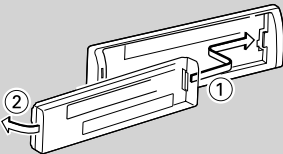

- The faceplate is a precision piece of equipment and can be damaged by shocks or jolts.
- Do not place the faceplate (and the faceplate case) in areas exposed to direct sunlight, excessive heat or humidity. Also avoid places with too much dust or the possibility of water splashing.
- To prevent deterioration, do not touch the terminals of the unit or faceplate with your fingers.

Auxiliary input

Connect a portable audio device with mini-plug cable (3.5 ϕ).



- Use the mini-plug cable which is stereo type and does not have any resistance.

Muting volume upon reception of phone call

When there is a call, "CALL" is displayed and the audio system is paused.

When the call ends, "CALL" disappears and the audio system comes back on.

The audio system comes back on when [SRC] is pressed during a call.

Subwoofer output: [AM-]

Switches between ON ("SW ON") and OFF ("SW OFF") each time the bottom side is pressed for at least 2 seconds.

Switching display: [DISP]

Changing the information displayed. Refer to page 6 for the details of the display setting.

Tuner functions

FM Band : [FM+]

Switches between FM1, FM2, and FM3 each time the [FM+] button is pressed.

AM Band: [AM-]

Switches to AM.

Switches between MW, SW1, and SW2 each time the [AM-] button is pressed. (KDC-MP243SW only)

Tuning: [◀◀]/[▶▶]

Changes the frequency.



- During reception of stereo stations the "ST" indicator is ON.

Auto memory entry: [FM+]

Memorizes 6 stations with good reception automatically when pressed for at least 2 seconds.

Preset memory: [1] - [6]

Memorize the station selected when pressing for at least 2 seconds.

Preset tuning: [1] - [6]

Recalls the memorized station.

Disc play functions

Disc play: Disc slot

Starts playing when a disc is inserted.

When a CD is inserted, the "IN" indicator is ON.



- 3 inch (8 cm) CD cannot be used. Attempt to insert using an adapter can cause malfunction.
- Refer to <About Audio file> (page 14) for the Audio file by models you can play.

Pause and play: [6]

Switches between pause and play each time this button is pressed.

Disc ejection: [▲]



- You can eject the disc for 10 minutes after switching off the engine.

Music search: [◀◀]/[▶▶]

Changes the music when this button is pressed.

Fast reverses or forwards the music while pressing.

Folder/Disc search: [FM+]/[AM-]

Switches the folder containing the audio file or the disc in the disc changer.

Track/ File/ Disc/ Folder repeat play: [4]

Switches between Track Repeat ("TRAC REP"), Disc Repeat ("DISC REP") (In Disc Changer), and OFF ("REP OFF") when pressed while playing a CD.

Switches between File Repeat ("FILE REP"), Folder Repeat ("FOLD REP"), and OFF ("REP OFF") when pressed while playing an audio file.

Scan play: [2]

Successfully plays the intro of the music in the disc or folder.

"TRAC SCN"/ "FILE SCN" is displayed during Scan Play.

Random play: [3]

Randomly plays the music in the disc or folder.

"DISC RDM"/ "FOLD RDM" is displayed during Random Play.

Magazine random play (KDC-MP443): [5]

Randomly plays the music in the disc changer.

"MGZN RDM" is displayed during Magazine Random Play.

Text/Title scroll: [DISP]

Scrolls the CD and audio file text display when pressing the top side for at least 1 second.

General Operation

Audio Control

1 Select the source to adjust
Press the [SRC] button.

2 Enter Audio Control mode
Press the [AUD] knob.

3 Select the Audio item to adjust
Press the [AUD] knob.

Adjustment Item	Display	Range
Subwoofer level	"SW L"	-15 — +15
Bass Boost	"B.BOOST"/"B.B"	"1"/"2"/"OFF" (The indicator turns on according to the setting.)
System Q	"NATURAL"/"ROCK"/ "POPS"/"EASY"/ "TOP40"/"JAZZ"/ "GAME"/"USER"	Natural/Rock/Pops/Easy/ Top 40/Jazz/Game/User setting
Bass level	"BAS L"	-8 — +8
Middle level	"MID L"	-8 — +8
Treble level	"TRE L"	-8 — +8
Balance	"BAL"	Left 15 — Right 15
Fader	"FAD"	Rear 15 — Front 15

Exit Audio Control mode (Volume control mode)



- "USER": This appears when Bass level, Middle level, and Treble level are adjusted. When "USER" is selected, these levels are recalled.

4 Adjust the Audio item
Turn the [AUD] knob.

5 Exit Audio Control mode
Press any button.

Press a button other than the [AUD] knob.

Audio Setup

Setting the Sound system.

1 Select the source to adjust
Press the [SRC] button.

2 Enter Audio Setup mode
Press the [AUD] knob for at least 1 second.

3 Select the Audio Setup item to adjust
Press the [AUD] knob.

Adjustment Item	Display	Range
Low Pass Filter	"LPE"	80/120/160/Through(OFF) Hz
Volume offset	"V-OFF"	-8 — ±0 (AUX: -8 — +8)



- Volume offset: Sets each source's volume as a difference from the basic volume.

4 Adjust the Audio setup item
Turn the [AUD] knob.

5 Exit Audio Setup mode
Press the [AUD] knob for at least 1 second.

Speaker Setting

Fine-tuning so that the System Q value is optimal when setting the speaker type.

1 Enter Standby
Press the [SRC] button.
Select the "STANDBY" display.

2 Enter Speaker Setting mode
Press the [AUD] knob.

3 Select the Speaker type
Turn the [AUD] knob.

Speaker type	Display
OFF	"SP OFF"
For 5 & 4 in. speaker	"SP 5/4"
For 6 & 6x9 in. speaker	"SP 6*9/6"
For the OEM speaker	"SP OEM"

4 Exit Speaker Setting mode
Press the [AUD] knob.

Switching Display

Changes displayed information on each source following;

In Tuner source

Information	Display
Frequency	"FREQ"
Clock	"CLOCK"

In CD & External disc source

Information	Display
Disc title	"D-TITLE"
Track title	"T-TITLE"
Play time & Track number	"P-TIME"
Clock	"CLOCK"

In Audio file source

Information	Display
Music title & Artist name	"TITLE"
Album name & Artist name	"ALBUM"
Folder name	"FOLDER"
File name	"FILE"
Play time & Music number	"P-TIME"
Clock	"CLOCK"

In Standby/ Auxiliary input source

Information	Display
Source name	"SRC NAME"
Clock	"CLOCK"



- When you select the clock display, the display setting of each source will be changed to the clock display.
- Album name cannot be displayed in WMA file.
- If the selected display item does not have any information, alternative information is displayed.

Manual Clock Adjustment

1 Select the Clock display

Press the [DISP] button.

2 Enter Clock Adjust mode

Press the [DISP] button for at least 1 second.

The clock display blinks.

3 Adjust the hours

Press the [FM+] or [AM-] button.

Adjust the minutes

Press the [◀◀] or [▶▶] button.

4 Exit Clock adjustment mode

Press the [DISP] button.

Tuner Operation

Frequency Step Setting

Changing the tuning frequency step.

The original setting is FM band 50 kHz, and AM band 9 kHz.

1 Turn the power OFF

Press the [SRC] button for at least 1 second.

2 Switch the frequency step

While pressing the [1] and [5] buttons, press the [SRC] button.

Release your fingers from the button after the display appears.

The frequency step changes to FM band 200 kHz, and AM band 10 kHz.



- When the same operation is repeated, the frequency step returns to the original setting.
- When the frequency step is changed, the frequencies in the memory are deleted.

Music disc/Audio file Operation

Function of KDC-MP443/KDC-MP3043/KDC-MP343
Function of remote control

Direct Music Search

Doing Music Search by entering the music number.

1 Enter the music number

Press the number buttons on the remote control.

2 Do music Search

Press the [◀◀] or [▶▶] button.

Canceling Direct Music Search

Press the [▶||] button.

 (ON) : Indicates that a folder exists above the currently selected folder.

 (OFF) : Indicates that no folder exists above the currently selected folder.

 (ON) : Indicates that a folder exists under the currently selected folder.

 (Blinking) : Indicates that your selection is a file.

Canceling the Music Search mode

Press the Search button.



- Music Search cannot be performed during Random play or scan play.

Function of KDC-MP443
Function of disc changers with remote control

Direct Disc Search

Doing Disc Search by entering the disc number.

1 Enter the disc number

Press the number buttons on the remote control.

2 Do Disc Search

Press the [+] or [-] button.

Canceling Direct Disc Search

Press the [▶||] button.



- Input "0" to select disc 10.

Music Search (Function of Audio file)

Search for the song you want to listen to by tracing the media file structure.

1 Enter Music Search mode

Press the Search button.

"SEARCH" is displayed.

Displays the current Audio file name.

2 Searching for and playing a song

Operation type	Operation
Movement between folders/files	Turn the [AUD] knob, or press the [FM+]/[AM-] button.
Selection of folder/file	Press the [AUD] knob or [▶▶] button.
Return to previous folder	Press the [◀◀] button.
Return to root folder	Press the [◀◀] button for at least 1 second.

Music Search (Function of Music CD)

Select the song you want to listen to by turning the [AUD] knob.

1 Enter Music Search mode

Press the Search button.

"SEARCH" is displayed.

Displays the current music No.

2 Select the music

Turn the [AUD] knob.

3 Play the selected song

Press the [AUD] knob.

The Music Search mode is canceled and the selected song is played.

Returning to the first song

Press the [◀◀] button for at least 1 second.

Canceling the Music Search mode

Press the Search button.



- Music Search is available only during playing of the built-in CD player.
- Music Search cannot be performed during Random play or scan play.

Menu Operation

Menu System

Setting various functions.

1 Enter Menu mode

Press the Search button for at least 1 second.

"MENU" is displayed.

2 Select the menu item

Press the [FM+] or [AM-] button.

Display	Setting	Setting overview	Source
"CODE SET"/ "CODE CLR"	Refer to page 10/11	Sets/Resets security code. (Function of KDC-MP443)	SB
"DIM"	ON/OFF*	Adjusts the brightness of the display according to the surrounding illumination.	—
"ICON"	ON1/ON2*/ OFF	Sets the Graphics mode of the display.	SB
"SWPRE"	R*/ SW	Sets the preout output.	SB
"SPRM"	ON*/OFF	Turns ON/OFF the Supreme function.	AF
"LO.S"* ¹	ON/OFF*	Only stations whose reception is good are searched in auto seek tuning.	AM
"AUTO1"/ "AUTO2"/ "MANUAL"	AUTO1*/ AUTO2/ MANUAL	Selects the tuning mode of the radio.	TUN
"CRSC"	OFF/ON*	Switches to Monaural to decrease noise when reception is poor.	FM
"NAME SET"	Refer to page 11	Sets the display when switched to AUX source.	AUX
"SCL"	AUTO*/ MANU	Specifies whether the text is scrolled automatically.	—
"AUX"	OFF/ON1*/ ON2	Sets whether to display AUX during source selection.	SB
"CD READ"	1*/2	Sets the CD read mode.	SB
"DEMO"	Refer to page 12	Specifies whether to enable demonstration.	—

*Factory setting

¹Function of KDC-MP243SW

Displayed item is depending on currently selected source. The mark in Source column shows the source to which the item is displayed.

SB : Can be set in other than standby state.

SB : Can be set in standby state.

AF : Can be set while Audio file source.

TUN : Can be set while Tuner source.

FM : Can be set during FM reception.

AM : Can be set during AM reception.

AUX : Can be set while accessing AUX source.

— : Can be set during all sources.



- Refer to the respective page for information on how to set the items with reference page number.
- Refer to the <Appendix> (page 14) for the details of the menu items.

3 Set the menu item

Press the [◀◀] or [▶▶] button.

4 Exit Menu mode

Press the Search button.

Function of KDC-MP443

Activating Security Code

When Security Code is set, possibility of theft is reduced because input of Security Code is prompted to turn on the unit once it is turned off.



- You can set the Security Code with a 4 digit number of your choice.
- The Security Code cannot be displayed or referenced. Make a note of the Security Code and treasure it up.

1 Enter Standby

Press the [SRC] button.

Select the "STANDBY" display.

2 Enter Menu mode

Press the Search button for at least 1 second.

When "MENU" is displayed, "CODE SET" is also displayed.

3 Enter Security Code mode

Press the [AUD] knob for at least 1 second.

When "ENTER" is displayed, "CODE" is also displayed.

4 Select the digits to enter

Press the [◀◀] or [▶▶] button.

5 Select the Security Code numbers

Press the [FM+] or [AM-] button.

6 Repeat steps 4 and 5, and complete the Security Code.

7 Confirm the Security Code

Press the [AUD] knob for at least 3 seconds.

When "RE-ENTER" is displayed, "CODE" is also displayed.

8 Do the step 4 through 7 operation, and reenter the Security Code.

"APPROVED" is displayed.

The Security Code function activates.



- If you enter the wrong Code in steps 4 through 6, repeat from step 4.

9 Exit Security Code mode

Press the Search button.

Resetting the Security Code function when the audio unit is first used after removed from the battery power source or the Reset button is pressed

1 Turn the power ON.

2 Do the step 4 through 7 operation, and enter the Security Code.

“APPROVED” is displayed.

Now, you can use the unit.



- When the Security Code function is activated, “CODE SET” changes to “CODE CLR”.
- To deactivate the Security Code function, see the next section <Deactivating Security Code>.

Function of KDC-MP443

Deactivating Security Code

To deactivate the Security Code function.

1 Enter Standby

Press the [SRC] button.

Select the “STANDBY” display.

2 Enter Menu mode

Press the Search button for at least 1 second.

“MENU” is displayed.

3 Select Security Code mode

Press the [FM+] or [AM-] button.

Select the “CODE CLR” display.

4 Enter Security Code mode

Press the [AUD] knob for at least 1 second.

When “ENTER” is displayed, “CODE CLR” is also displayed.

5 Select the digits to enter

Press the [◀◀] or [▶▶] button.

6 Select the Security Code numbers

Press the [FM+] or [AM-] button.

7 Repeat steps 4 and 5, and complete the Security Code.

8 Press the [AUD] knob for at least 3 seconds.

“CLEAR” is displayed.

The Security Code function deactivates.

9 Exit Security Code mode

Press the Search button.



- If a wrong security code is entered, “ERROR” is displayed. Enter a correct security code.

Auxiliary Input Display Setting

Selecting the display when changing to Auxiliary input source.

1 Select Auxiliary input source

Press the [SRC] button.

Select the “AUX” display.

2 Enter Menu mode

Press the Search button for at least 1 second.

“MENU” is displayed.

3 Select Auxiliary input display setting mode

Press the [FM+] or [AM-] button.

Select the “NAME SET” display.

4 Enter Auxiliary input display setting mode

Press the [AUD] knob for at least 1 second.

The presently selected Auxiliary input display is displayed.

5 Select the Auxiliary input display

Press the [◀◀] or [▶▶] button.

Each time you push the knob, the display alternates as listed below.

- “AUX”
- “DVD”
- “PORTABLE”
- “GAME”
- “VIDEO”
- “TV”

6 Exit Auxiliary input display setting mode

Press the Search button.



- When operation stops for 10 seconds, the name at that time is registered, and the Auxiliary input display setting mode closes.
- The Auxiliary input display can be set only when the built-in auxiliary input or the auxiliary input of optional KCA-S220A is used. On the KCA-S220A, “AUX EXT” is displayed by default.

Menu Operation

Demonstration mode Setting

Sets the demonstration mode.

1 Enter Menu mode

Press the Search button for at least 1 second.

"MENU" is displayed.

2 Select the Demonstration mode

Press the [FM+] or [AM-] button.

Select the "DEMO" display.

3 Set the Demonstration mode

Press the [AUD] knob for at least 2 seconds.

Each time you press the knob at least 2 seconds, the Demonstration mode alternates between the settings shown in the table below.

Display	Setting
"DEMO ON"	The Demonstration mode function is ON.
"DEMO OFF"	Exit Demonstration mode (Normal mode).

Basic Operations of remote control

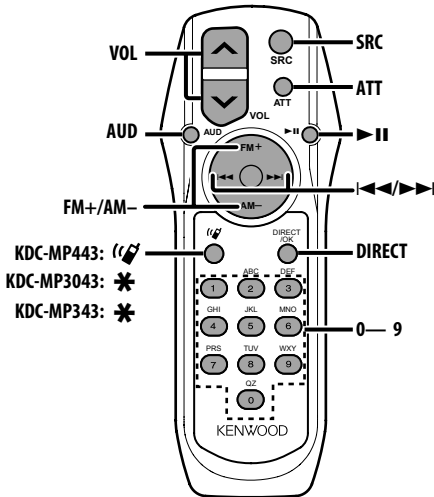

General control

Volume control: [VOL]

Source select: [SRC]

Volume reduce: [ATT]

When the button is pressed again, the volume returns to the previous level.

In Audio control

Audio item select: [AUD]

Adjusts the Audio item: [VOL]



- Refer to <Audio Control> (page 6) for the operation method, such as the procedures for Audio control and others operations.

In Tuner source

Band select: [FM+]/[AM-]

Station select: [|◀◀]/[▶▶ |]

Recall preset stations: [1] — [6]

In Disc source

Music select: [|◀◀]/[▶▶ |]

Folder/Disc select: [FM+]/[AM-]

Pause/Play : [▶▶ |]



About [Bluetooth icon] (KDC-MP443)

This button is used when Bluetooth HANDS FREE BOX is connected. For more information, refer to the instruction manual of Bluetooth HANDS FREE BOX.

About [*] (KDC-MP3043/KDC-MP343)

Not used.

About [DIRECT]

Not used.



- Do not set the remote control in hot places such as on the dashboard.

Loading and Replacing the battery

Use two "AA"/"R6"-size batteries.

Slide the cover while pressing downwards to remove it as illustrated.

Insert the batteries with the + and - poles aligned properly, following the illustration inside the case.

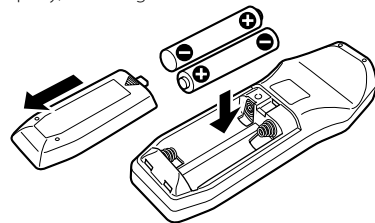

Appendix

About Audio file

- **Playable Audio file**

MP3 (.mp3), WMA (.wma)

- **Playable disc media**

CD-R/RW/ROM

- **Playable disc file format**

ISO 9660 Level 1/2, Joliet, Romeo, Long file name.

Although the audio files are complied with the standards listed above, the play maybe impossible depending on the types or conditions of media or device.

- **Playing order of the Audio file**

In the example of folder/file tree shown below, the files are played in the order from ① to ⑩.

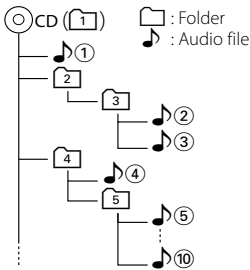

An online manual about audio files is put on the site, www.kenwood.com/audiophile/. On this online manual, detailed information and notes which are not written in this manual are provided. Make sure to read through the online manual as well.

For operating KCA-BT200 (optional)

For operation refer to Model-A-1 in the Instruction Manual of KCA-BT200, and the table below. The [AUTO]/[TI] button should be replaced with [SRC] button for <Answering the Waiting Call after Terminating the Current Call>.

Notation used in the KCA-BT200 Instruction Manual	Operation
▶ button	[AUD] knob
Control knob	[AUD] knob
[AUTO]/[TI] button	[DISP] button
Control knob towards up or down	[FM+] or [AM-] button
Control knob towards left or right	[◀◀] or [▶▶] button

For operating KCA-BT100 (optional)

To control KCA-BT100, operate as follows;

To make setting for <Selecting the Dialing Mode>, select <Menu System> (page 10). Pressing the [AUD] knob for at least 1 second after selecting the "D.MODE" item allows you to enter the dialing method selection mode. To exit from dialing method selection mode, press Search button.

To make <Disconnecting a Call>, <Clearing the Disconnection Message>, and <Rejecting an Incoming call>, press [DISP] button for at least 1 second.

Moreover, some displays are different from the description of KCA-BT100 Instruction Manual.

Displays of KCA-BT100 Instruction Manual	Actual displays on this unit
"DISCONNECT"	"HF D-CON"
"CONNECT"	"HF CON"
"PHN-DEL"	"DVC-DEL"
"P-STATUS"	"D-STATUS"
"BT-CON Y"	"HF-CON Y"
"BT-CON N"	"HF-CON N"

Menu Glossary

• SWPRE (Switching Preout)

Switches the preout between rear output ("R") and subwoofer output ("SW").

• SPRM (Supreme)

Technology to extrapolate and supplement with proprietary algorithm, the high-frequency range that is cut off when encoding at low bit rate. Supplementing is optimized by compression format (MP3 or WMA) and processed according to bit rate.

The effect is negligible with music that is encoded at high bit rate, variable bit rate or has minimal high frequency range.

• CD READ

Sets the method for reading CD.

When unable to play special format CD, set this function to "2" to force playing. Note that some music CD may be unplayable even when set to "2". In addition, audio files cannot be played when set to "2". Normally, keep this set to "1".

1 : Automatically distinguishes between audio file disc and music CD when playing disc.

2 : Forces playing as music CD.

• AUX

When this is set to ON, AUX source can be selected.

ON1: Outputs the sound of external unit connected to the AUX terminal when switched to AUX source.

ON2: Activates the attenuator function when switched to AUX source.

Turn off the attenuator function when listening to output from external unit. This prevents the noise when no external unit is connected to AUX terminal.

OFF: Disables the selection of AUX source.

Set to OFF when not using the AUX terminal.

• AUTO1, AUTO2, MANUAL (Tuning mode select)

Select a tuning mode of the radio.

Tuning mode	Display	Operation
Auto seek	"AUTO1"	Automatic search for a station.
Preset station seek	"AUTO2"	Search in order of the stations in the Preset memory.
Manual	"MANUAL"	Normal manual tuning control.

• LO.S

When this function is turned on the auto seek turning automatically searches for station with good reception.

It is especially useful searching station with SW1 band or SW2 band.

• ICON

Sets the Graphics mode of the display during normal playback condition.

ON1: Turns on.

ON2: Displays an animation.

OFF: Turns off.

The marking of products using lasers (Except for some areas)

**CLASS 1
LASER PRODUCT**

The label is attached to the chassis/case and says that the component uses laser beams that have been classified as Class 1. This means that the unit is utilizing laser beams that are of a weaker class. There is no danger of hazardous radiation outside the unit.

Accessories/ Installation Procedure

Accessories

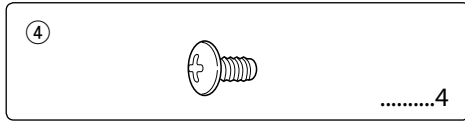
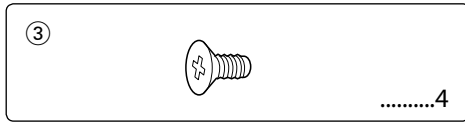
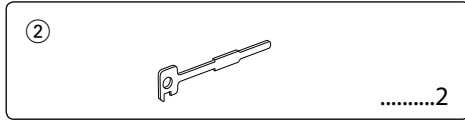
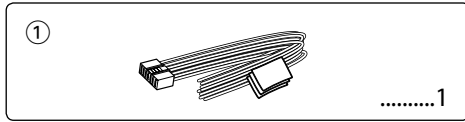

Installation Procedure

1. To prevent a short circuit, remove the key from the ignition and disconnect the ⊖ battery.
2. Make the proper input and output wire connections for each unit.
3. Connect the speaker wires of the wiring harness.
4. Connect the wiring harness wires in the following order: ground, battery, ignition.
5. Connect the wiring harness connector to the unit.
6. Install the unit in your car.
7. Reconnect the ⊖ battery.
8. Press the reset button.

▲WARNING

If you connect the ignition wire (red) and the battery wire (yellow) to the car chassis (ground), you may cause a short circuit, that in turn may start a fire. Always connect those wires to the power source running through the fuse box.



- Mounting and wiring this product requires skills and experience. For safety's sake, leave the mounting and wiring work to professionals.
- Make sure to ground the unit to a negative 12V DC power supply.
- Do not install the unit in a spot exposed to direct sunlight or excessive heat or humidity. Also avoid places with too much dust or the possibility of water splashing.

- Do not use your own screws. Use only the screws provided. If you use the wrong screws, you could damage the unit.
- If the power is not turned ON ("PROTECT" is displayed), the speaker wire may have a short-circuit or touched the chassis of the vehicle and the protection function may have been activated. Therefore, the speaker wire should be checked.
- If your car's ignition does not have an ACC position, connect the ignition wires to a power source that can be turned on and off with the ignition key. If you connect the ignition wire to a power source with a constant voltage supply, as with battery wires, the battery may die.
- If the console has a lid, make sure to install the unit so that the faceplate will not hit the lid when closing and opening.
- If the fuse blows, first make sure the wires aren't touching to cause a short circuit, then replace the old fuse with one with the same rating.
- Insulate unconnected wires with vinyl tape or other similar material. To prevent a short circuit, do not remove the caps on the ends of the unconnected wires or the terminals.
- Connect the speaker wires correctly to the terminals to which they correspond. The unit may be damaged or fail to work if you share the ⊖ wires or ground them to any metal part in the car.
- When only two speakers are being connected to the system, connect the connectors either to both the front output terminals or to both the rear output terminals (do not mix front and rear). For example, if you connect the ⊕ connector of the left speaker to a front output terminal, do not connect the ⊖ connector to a rear output terminal.
- After the unit is installed, check whether the brake lamps, blinkers, wipers, etc. on the car are working properly.
- Mount the unit so that the mounting angle is 30° or less.

About CD players/disc changers connected to this unit

If the CD player/ disc changer has the "O-N" switch, set it to the "N" position.

The functions you can use and the information that can be displayed may differ depending on the models being connected.

Connecting Wires to Terminals

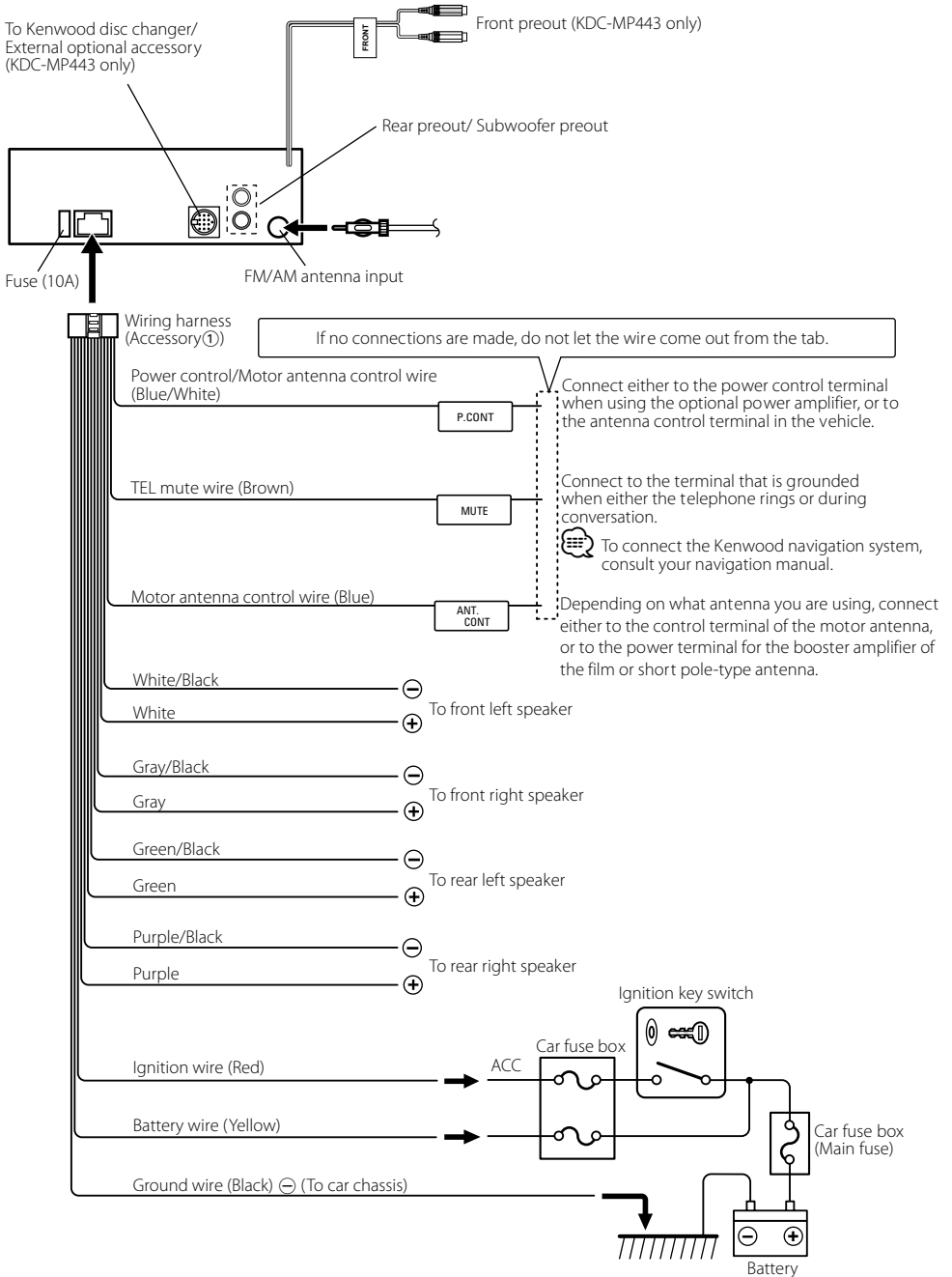

Installation

non-Japanese cars

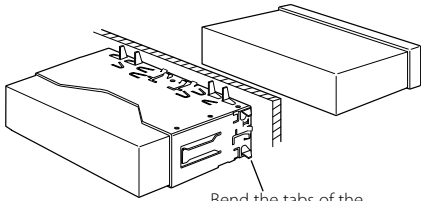

Bend the tabs of the mounting sleeve with a screwdriver or similar utensil and attach it in place.



- Make sure that the unit is installed securely in place. If the unit is unstable, it may malfunction (for example, the sound may skip).

Japanese cars

- 1 Refer to the section <Removing the hard rubber frame> and then remove the hard rubber frame.
- 2 Align the holes in the unit (two locations on each side) with the vehicle mounting bracket and secure the unit with the accessory screws.

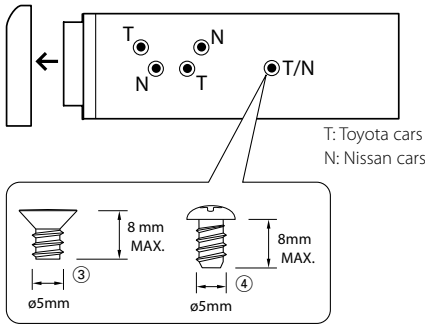

Accessory③...for Nissan car
Accessory④...for Toyota car

Removing the hard rubber frame

- 1 Engage the catch pins on the removal tool and remove the two locks on the upper level. Upper the frame and pull it forward as shown in the figure.

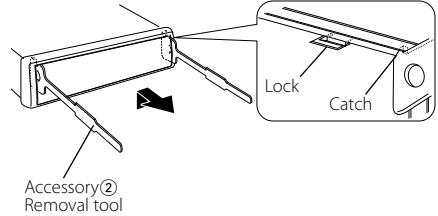

- 2 When the upper level is removed, remove the lower two locations.



- The frame can be removed from the bottom side in the same manner.

Removing the Unit

- 1 Refer to the section <Removing the hard rubber frame> and then remove the hard rubber frame.
- 2 Insert the two removal tools deeply into the slots on each side, as shown.
- 3 Lower the removal tool toward the bottom, and pull out the unit halfway while pressing towards the inside.

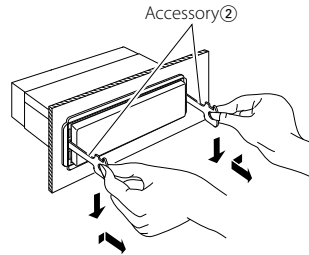

- Be careful to avoid injury from the catch pins on the removal tool.
- 4 Pull the unit all the way out with your hands, being careful not to drop it.

Troubleshooting Guide

Some functions of this unit may be disabled by some settings made on this unit.

! Cannot display the user of System Q.

- ▶ <Audio Control> (page 6) is not set.

! • Cannot set up the sub woofer. • No output from the sub woofer. • Cannot set up the low pass filter.

- ▶ • Preout is not set to subwoofer. Ⓢ "SWPRE" of <Menu System> (page 10)
- <Subwoofer Output> (page 4) is not set to On.

! • Cannot register a security code. • Cannot set up Display.

- ▶ <Demonstration mode Setting> (page 12) is not turned off.

What might seem to be a malfunction in your unit may just be the result of slight misoperation or miswiring. Before calling service, first check the following table for possible problems.

Tuner source

? Radio reception is poor.

- ✓ The car antenna is not extended.
- Ⓢ Pull the antenna out all the way.

Disc source

? The specified disc does not play, but another one plays instead.

- ✓ The specified CD is quite dirty.
- Ⓢ Clean the CD, referring to the CD cleaning of the section on <Handling CDs> (page 3).
- ✓ The disc is loaded in a different slot from that specified.
- Ⓢ Eject the disc magazine and check the number for the specified disc.
- ✓ The disc is severely scratched.
- Ⓢ Try another disc instead.

Audio file source

? The sound skips when an Audio file is being played.

- ✓ The media is scratched or dirty.
- Ⓢ Clean the media, referring to the CD cleaning of the section on <Handling CDs> (page 3).
- ✓ The recording condition is bad.
- Ⓢ Record the media again or use another media.

The messages shown below display your systems condition.

TOC ERR:	<ul style="list-style-type: none"> • No disc has been loaded in the disc magazine. • The CD is quite dirty. The CD is upside-down. The CD is scratched a lot.
E-05:	The disc is unreadable.
E-15:	Media was played that doesn't have data recorded that the unit can play.
E-77:	<p>The unit is malfunctioning for some reason.</p> <ul style="list-style-type: none"> ⇨ Press the reset button on the unit. If the "E-77" code does not disappear, consult your nearest service center.
E-99:	<p>Something is wrong with the disc magazine. Or the unit is malfunctioning for some reason.</p> <ul style="list-style-type: none"> ⇨ Check the disc magazine. And then press the reset button on the unit. If the "E-99" code does not disappear, consult your nearest service center.
READING:	The unit is reading the data on the disc.
IN (Blink):	<p>The CD player section is not operating properly.</p> <ul style="list-style-type: none"> ⇨ Reinsert the CD. If the CD cannot be ejected or the display continues to flash even when the CD has been properly reinserted, please switch off the power and consult your nearest service center.
PROTECT:	<p>The speaker wire has a short-circuit or touches the chassis of the vehicle, and then the protection function is activated.</p> <ul style="list-style-type: none"> ⇨ Wire or insulate the speaker cable properly and press the reset button. If the "PROTECT" code does not disappear, consult your nearest service center.
NA FILE:	<p>An Audio file is played with a format that this unit can't support.</p> <p>⇨ ----</p>
COPY PRO:	<p>A copy-protected file is played.</p> <p>⇨ ----</p>

Specifications

FM tuner section

Frequency range
200 kHz space : 87.9 MHz – 107.9 MHz
50 kHz space : 87.5 MHz – 108.0 MHz
Usable sensitivity (S/N = 30dB)
: 9.3dBf (0.8 μ V/75 Ω)
Quieting Sensitivity (S/N = 50dB)
: 15.2dBf (1.6 μ V/75 Ω)
Frequency response (\pm 3 dB)
: 30 Hz – 15 kHz
Signal to Noise ratio (MONO)
: 70 dB
Selectivity (\pm 400 kHz)
: \geq 80 dB
Stereo separation (1 kHz)
: 40 dB

AM tuner section

Frequency range
10 kHz space : 530 kHz – 1700 kHz
9 kHz space : 531 kHz – 1611 kHz
Usable sensitivity (S/N = 20dB)
: 28 dB μ (25 μ V)

AM tuner section (KDC-MP243SW)

Frequency range
Band1 (MW) : 530 kHz – 1700 kHz (10 kHz space)
: 531 kHz – 1611 kHz (9 kHz space)
Band2 (SW1) : 2940 kHz – 7735 kHz (5 kHz space)
Band3 (SW2) : 9500 kHz – 10135 kHz / 11580 kHz
- 18135 kHz (5 kHz space)
Usable sensitivity (S/N = 20dB)
: 28 dB μ (25 μ V)

CD player section

Laser diode
: GaAlAs
Digital filter (D/A)
: 8 Times Over Sampling
D/A Converter
: 24 Bit
Spindle speed
: 500 – 200 rpm (CLV)
Wow & Flutter
: Below Measurable Limit
Frequency response (\pm 1 dB)
: 20 Hz – 20 kHz
Total harmonic distortion (1 kHz)
: 0.01 %
Signal to Noise ratio (1 kHz)
: 105 dB
Dynamic range
: 93 dB

MP3 decode
: Compliant with MPEG-1/2 Audio Layer-3
WMA decode
: Compliant with Windows Media Audio

Audio section

Maximum output power
: 50 W x 4
Full Bandwidth Power (at less than 1% THD)
: 22 W x 4
Speaker Impedance
: 4 – 8 Ω
Tone action
Bass : 100 Hz \pm 8 dB
Middle : 1 kHz \pm 8 dB
Treble : 10 kHz \pm 8 dB
Preout level / Load (CD)
: 2000 mV/10 k Ω
Preout impedance
: \leq 600 Ω

Auxiliary input

Frequency response (\pm 1 dB)
: 20 Hz – 20 kHz
Input Maximum Voltage
: 1200 mV
Input Impedance
: 10 k Ω

General

Operating voltage (11 – 16V allowable)
: 14.4 V
Current consumption
: 10 A
Installation Size (W x H x D)
: 182 x 53 x 155 mm
Weight
: 1.30 kg

Specifications subject to change without notice.