

LCD Digital Colour TV

Operating Instructions

Start-up Guide

Operating the TV

Using Optional Equipment

Using Menu Functions

Additional Information

BRAVIA

Introduction

Thank you for choosing this Sony product.
Before operating the TV, please read this manual thoroughly and retain it for future reference.

The illustrations used in this manual are of the KDL-32BX320 unless otherwise stated.

Trademark information

- **DVB** is a registered trademark of the DVB Project.
- HDMI, the HDMI Logo, and High-Definition Multimedia Interface are trademarks or registered trademarks of HDMI Licensing LLC in the United States and other countries.
- Manufactured under license from Dolby Laboratories. Dolby and the double-D symbol are trademarks of Dolby Laboratories.
- DivX[®], DivX Certified[®] and associated logos are trademarks of DivX, Inc. and are used under license.

ABOUT DIVX VIDEO: DivX[®] is a digital video format created by DivX, Inc. This is an official DivX Certified[®] device that plays DivX video. Visit divx.com for more information and software tools to convert your files into DivX video.

ABOUT DIVX VIDEO-ON-DEMAND: This DivX Certified[®] device must be registered in order to play purchased DivX Video-on-Demand (VOD) movies. To obtain your registration code, locate the DivX VOD section in your device setup menu. Go to vod.divx.com for more information on how to complete your registration.

- “BRAVIA” and BRAVIA are trademarks of Sony Corporation.



Notes for Australia and New Zealand model

This product is ENERGY RATING qualified in the “Home” mode. ENERGY RATING is a programme designed to promote energy efficient products and practices.

- When the TV is initially set up, it is designed to meet ENERGY RATING requirements while maintaining optimum picture quality.
- Changes to certain features, settings and functionalities of this TV (e.g. TV Guide, Picture/Sound, Eco setting) can slightly change the power consumption.

Depending upon such changed settings (e.g. “Shop” mode), the power consumption may vary which possibly could exceed the stated energy rating. To reset the TV to ENERGY RATING qualified settings, select “Home” mode from the initial set-up procedure in “Factory Settings” under the “Set-up” menu.

Location of the identification label

Labels for Model No. and Power Supply rating (in accordance with applicable safety regulation) are located on the rear of the TV.

IMPORTANT INFORMATION

If a television is not positioned in a sufficiently stable location, it can be potentially hazardous due to falling. Many injuries, particularly to children, can be avoided by taking simple precautions such as:

- Using cabinets or stands recommended by the manufacturer of the television.
- Only using furniture that can safely support the television.
- Ensuring the television is not overhanging the edge of the supporting furniture.
- Not placing the television on tall furniture (for example, cupboards or bookcases) without anchoring both the furniture and the television to a suitable support.
- Not standing the televisions on cloth or other materials placed between the television and supporting furniture.
- Educating children about the dangers of climbing on furniture to reach the television or its controls.

Table of Contents

Start-up Guide

Checking the accessories	4
1: Attaching the stand.....	4
2: Connecting an antenna/cable/VCR	5
3: Preventing the TV from toppling over.....	5
4: Performing the initial set-up.....	6
Watching TV	6
Detaching the stand from the TV.....	6
Safety information	7
Precautions	8

Operating the TV

Overview of the remote	9
Overview of the TV buttons and indicators.....	11

Using Optional Equipment

Connecting optional equipment.....	12
Viewing pictures from the connected equipment.....	13
Viewing PIP (Picture in Picture).....	14

Using Menu Functions

Navigating through menus	15
Using the Digital Favourite list DVB	15
Using the Digital Electronic Programme Guide (EPG) DVB	16
Playing back photo/music/video via USB.....	17
Using BRAVIA Sync with Control for HDMI	20
Settings adjustment.....	21
Picture	21
Sound.....	22
Screen.....	24
Channel Set-up	26
Parental Lock	28
Set-up.....	29
Eco.....	30

Additional Information

Installing the accessories (Wall-Mount Bracket)	31
TV installation dimensions table.....	32
Screw and hook locations diagram/table	33
Troubleshooting	34
Specifications	36

DVB : for digital channels only

Before operating the TV, please read "Safety information" (page 7). Retain this manual for future reference.

Start-up Guide

Checking the accessories

Stand (1) and screws (7)

Remote RM-ED046 (1)

Size AA batteries (R6 type) (2)

To insert batteries into the remote

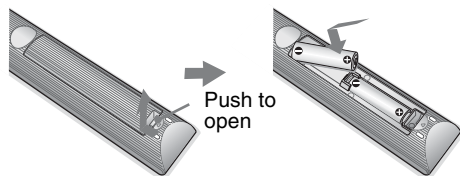

1: Attaching the stand

- Refer to the supplied stand leaflet for proper attachment for some TV models.

► KDL-40BX420/KDL-32/26BX320

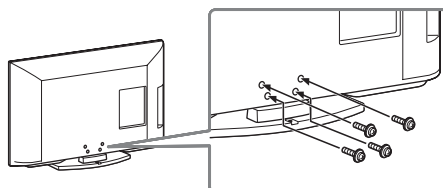
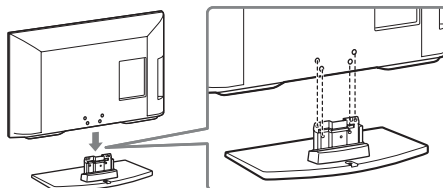

► KDL-22BX320

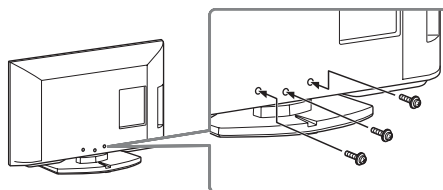
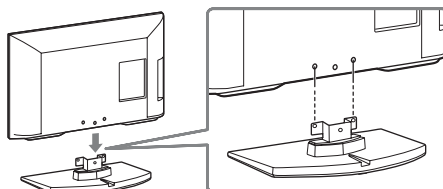

- Fix the TV to the stand according to the arrow marks  that guide the screw holes using the supplied screws.
- This TV is very heavy, so two or more people should place the TV onto the stand.
- If using an electric screwdriver, set the tightening torque at approximately 1.5 N·m (15 kgf·cm).
- Ensure the AC power cord is away from screw holes during stand installation to avoid damage to the AC power cord.

2: Connecting an antenna/cable/VCR

 • Connecting cables are not supplied.

Connecting an antenna/cable

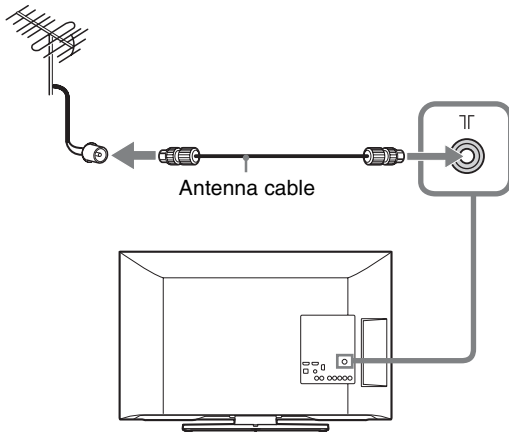

Connecting an antenna/cable and VCR

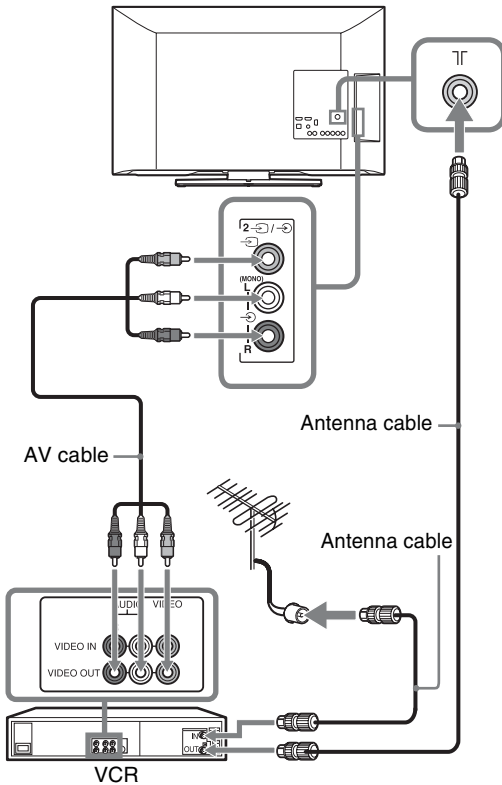

3: Preventing the TV from toppling over

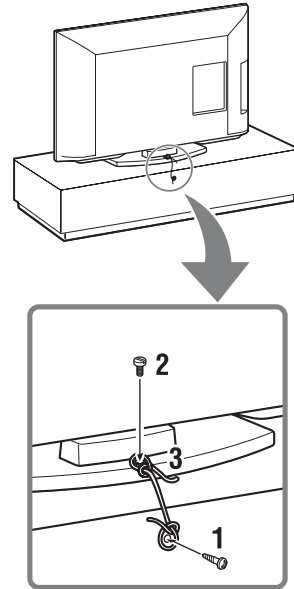

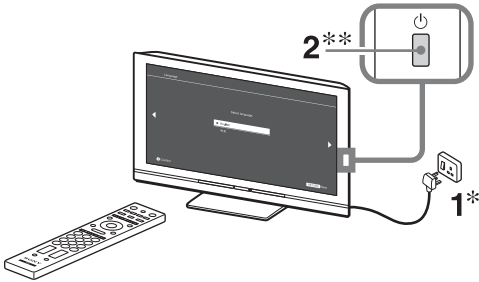

- 1** Install a wood screw (4 mm in diameter, not supplied) in the TV stand.
 - 2** Install a machine screw (M4 × 16, not supplied) into the screw hole of the TV.
 - 3** Tie the wood screw and the machine screw with a strong cord (not supplied).
-  • An optional Sony support belt kit is used to secure the TV. Contact your nearest Sony service centre to purchase a kit. Have your TV model name ready for reference.

4: Performing the initial set-up



* The shapes of AC power plug and AC power outlet differ depending on the region.

**When the TV is in standby mode (the  indicator on the TV front panel is red), press  on the remote to turn on the TV.

3





Follow the instructions on the screen.

“Programme Sorting”: If you want to change the order of analogue channels, follow the steps in “Programme Sorting” (page 26).

Press **HOME** to exit.

 • You can also tune channels manually (page 26).

Watching TV

- 1 Press  on the TV to turn on the TV.
- 2 Press **DIGITAL/ANALOG** to switch between digital and analogue modes.
- 3 Press the number buttons or **PROG +/-** to select a TV channel.
- 4 Press  to adjust the volume.

Detaching the stand from the TV

 • Do not remove the stand for any reason other than to wall-mount the TV.

► **KDL-40BX420/KDL-32/26BX320**

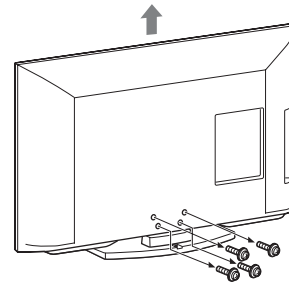

► **KDL-22BX320**

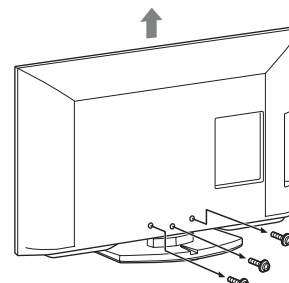

Safety information

Installation/Set-up

Install and use the TV set in accordance with the instructions below in order to avoid any risk of fire, electrical shock or damage and/or injuries.

Installation

- The TV set should be installed near an easily accessible AC power outlet.
- Place the TV set on a stable, level surface to avoid it from falling down and cause personal injury or damage to the TV.
- Only qualified service personnel should carry out wall installations.
- For safety reasons, it is strongly recommended that you use Sony accessories, including:
 - KDL-40BX420/32BX320: Wall-mount bracket SU-WL50B
 - KDL-26BX320/22BX320: Wall-mount bracket SU-WL100
- Be sure to use the screws supplied with the Wall-mount bracket when attaching the mounting hooks to the TV set. The supplied screws are designed as indicated by illustration when measured from the attaching surface of the mounting hook. The diameter and length of the screws differ depending on the Wall-mount bracket model. Use of screws other than those supplied may result in internal damage to the TV set or cause it to fall, etc.

Min. ~ 26 TV: 6.5 ~ 10mm
32 TV ~ Max.: 8 ~ 12mm

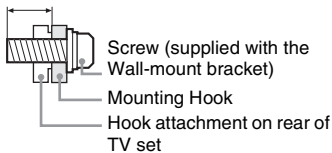

Transporting

- Before transporting the TV set, disconnect all cables.
- Two or more people are needed to transport a large TV set.
- When transporting the TV set by hand, hold it as shown below. Do not put stress on the LCD panel.

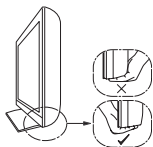
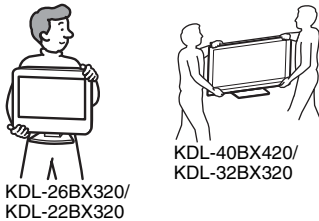

- When lifting or moving the TV set, hold it firmly from the bottom.
- When transporting the TV set, do not subject it to jolts or excessive vibration.
- When transporting the TV set for repairs or when moving, pack it using the original carton and packing material.

Ventilation

- Never cover the ventilation holes or insert anything in the cabinet.
- Leave space around the TV set as shown below.
- It is strongly recommended that you use a Sony wall-mount bracket in order to provide adequate air-circulation.

Installed on the wall

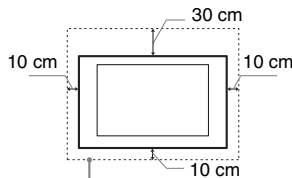

Leave at least this space around the set.

Installed with stand

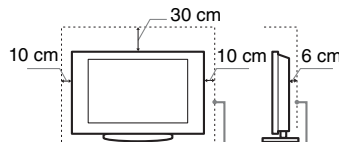

Leave at least this space around the set.

- To ensure proper ventilation and prevent the collection of dirt or dust:
 - Do not lay the TV set flat, install upside down, backwards, or sideways.
 - Do not place the TV set on a shelf, rug, bed or in a closet.
 - Do not cover the TV set with a cloth, such as curtains, or items such as newspapers, etc.
 - Do not install the TV set as shown below.

Air circulation is blocked.

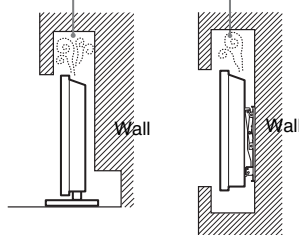

AC power cord

- Handle the AC power cord and outlet as follows in order to avoid any risk of fire, electrical shock or damage and/or injuries:
- The shape of AC power plug, which is supplied with the TV set, varies depending on the regions. Be sure to connect the appropriate supplied AC power cord with the plug that fits into the AC power outlet.
 - Use only Sony supplied AC power cords, not those of other brands.
 - Insert the plug fully into the AC power outlet.
 - Operate the TV set on a 110-240 V AC supply only.
 - When wiring cables, be sure to unplug the AC power cord for your safety and take care not to catch your feet on the cables.
 - Disconnect the AC power cord from the AC power outlet before working on or moving the TV set.
 - Keep the AC power cord away from heat sources.
 - Unplug the AC power plug and clean it regularly. If the plug is covered with dust and it picks up moisture, its insulation may deteriorate, which could result in a fire.

Notes

- Do not use the supplied AC power cord on any other equipment.
- Do not pinch, bend, or twist the AC power cord excessively. The core conductors may be exposed or broken.
- Do not modify the AC power cord.
- Do not put anything heavy on the AC power cord.
- Do not pull on the AC power cord itself when disconnecting the AC power cord.
- Do not connect too many appliances to the same AC power outlet.
- Do not use a poor fitting AC power outlet.

Prohibited Usage

Do not install/use the TV set in locations, environments or situations such as those listed below, or the TV set may malfunction and cause a fire, electrical shock, damage and/or injuries.

Location:

- Outdoors (in direct sunlight), at the seashore, on a ship or other vessel, inside a vehicle, in medical institutions, unstable locations, near water, rain, moisture or smoke.
- If the TV is placed in the changing room of a public bath or hot spring, the TV may be damaged by airborne sulfur, etc.

Environment:

- Places that are hot, humid, or excessively dusty; where insects may enter; where it might be exposed to mechanical vibration, near flammable objects (candles, etc). The TV set shall not be exposed to dripping or splashing and no objects filled with liquids, such as vases, shall be placed on the TV.
- Do not place the TV in a humid or dusty space, or in a room with oily smoke or steam (near cooking tables or humidifiers). Fire, electric shock, or warping may result.

Continued

Situation:

- Do not use when your hands are wet, with the cabinet removed, or with attachments not recommended by the manufacturer. Disconnect the TV set from AC power outlet and antenna during lightning storms.
- Do not install the TV so that it sticks out into an open space. Injury or damage from a person or object bumping into the TV may result.

Broken pieces:

- Do not throw anything at the TV set. The screen glass may break by the impact and cause serious injury.
- If the surface of the TV set cracks, do not touch it until you have unplugged the AC power cord. Otherwise electric shock may result.

When not in use

- If you will not be using the TV set for several days, the TV set should be disconnected from the AC power for environmental and safety reasons.
- As the TV set is not disconnected from the AC power when the TV set is just turned off, pull the plug from the AC power outlet to disconnect the TV set completely.
- However, some TV sets may have features that require the TV set to be left in standby to work correctly.

For children

- Do not allow children to climb on the TV set.
- Keep small accessories out of the reach of children, so that they are not mistakenly swallowed.

If the following problems occur...

Turn off the TV set and unplug the AC power cord immediately if any of the following problems occur.

Ask your dealer or Sony service centre to have it checked by qualified service personnel.

When:

- AC power cord is damaged.
- Poor fitting of AC power outlet.
- TV set is damaged by being dropped, hit or having something thrown at it.
- Any liquid or solid object falls through openings in the cabinet.

About LCD Monitor Temperature

When the LCD Monitor is used for an extended period, the panel surrounds become warm. You may feel hot when touching there by the hand.

Precautions

Viewing the TV

- View the TV in moderate light, as viewing the TV in poor light or during long period of time, strains your eyes.
- When using headphones, adjust the volume so as to avoid excessive levels, as hearing damage may result.

LCD Screen

- Although the LCD screen is made with high-precision technology and 99.99% or more of the pixels are effective, black dots may appear or bright points of light (red, blue, or green) may appear constantly on the LCD screen. This is a structural property of the LCD screen and is not a malfunction.
- Do not push or scratch the front filter, or place objects on top of this TV set. The image may be uneven or the LCD screen may be damaged.
- If this TV set is used in a cold place, a smear may occur in the picture or the picture may become dark. This does not indicate a failure. These phenomena disappear as the temperature rises.
- Ghosting may occur when still pictures are displayed continuously. It may disappear after a few moments.
- The screen and cabinet get warm when this TV set is in use. This is not a malfunction.
- The LCD screen contains a small amount of liquid crystal. Some fluorescent tubes used in this TV set also contain mercury. Follow your local ordinances and regulations for disposal.

Handling and cleaning the screen surface/cabinet of the TV set

Be sure to unplug the AC power cord connected to the TV set from AC power outlet before cleaning.

To avoid material degradation or screen coating degradation, observe the following precautions.

- To remove dust from the screen surface/cabinet, wipe gently with a soft cloth. If dust is persistent, wipe with a soft cloth slightly moistened with a diluted mild detergent solution.
- Do not spray water or detergent directly on the TV set. It may drip to the bottom of the screen or exterior parts, and may cause a malfunction.
- Never use any type of abrasive pad, alkaline/acid cleaner, scouring powder, or volatile solvent, such as alcohol, benzene, thinner or insecticide. Using such materials or maintaining prolonged contact with rubber or vinyl materials may result in damage to the screen surface and cabinet material.
- Periodic vacuuming of the ventilation openings is recommended to ensure to proper ventilation.
- When adjusting the angle of the TV set, move it slowly so as to prevent the TV set from moving or slipping off from its table stand.

Optional Equipment

Keep optional components or any equipment emitting electromagnetic radiation away from the TV set. Otherwise picture distortion and/or noisy sound may occur.

(Caution about handling the remote control)

Notes

- Observe the correct polarity when inserting batteries.
- Do not use different types of batteries together or mix old and new batteries.
- Dispose of batteries in an environmentally friendly way. Certain regions may regulate the disposal of batteries. Please consult your local authority.
- Handle the remote with care. Do not drop or step on it, or spill liquid of any kind onto it.
- Do not place the remote in a location near a heat source, a place subject to direct sunlight, or a damp room.

Disposal of the TV set (Australian model only)



Disposal of Old Electrical & Electronic Equipment (Applicable in the European Union and other

European countries with separate collection systems)

This symbol is on the remote control.

Overview of the remote

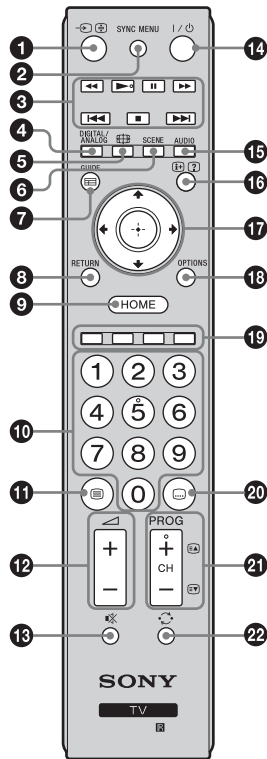

• The number 5, **PROG +** and **AUDIO** buttons have tactile dots. Use the tactile dots as references when operating the TV.

- 1 – **Input select / Text hold**
 - Displays the connected equipment list and selects the input source (page 13).
 - In Text mode: Holds the current page.
- 2 **SYNC MENU**

Press to display the BRAVIA Sync Menu and then select connected HDMI equipment from “HDMI Device Selection”.
The following options can be selected from BRAVIA Sync Menu:

 - “**Device Control**”: Use the “Device Control” menu to operate equipment that is compatible with Control for HDMI. Select options from “Home (Menu)”, “Options” and “Content List” to operate the equipment.
 - “**Speakers**”: Selects “TV Speakers” or “Audio System” to output the TV’s sound from the TV speakers or connected audio equipment.
 - “**TV Control**”: Use the “TV Control” menu to operate the TV from the “HOME (Menu)” or “Options” menu.
 - “**Return to TV**”: Selects this option to return to TV programme.
- 3

You can operate the BRAVIA Sync-compatible equipment that is connected to the TV. Some other buttons on the remote control may also operate BRAVIA Sync equipment.
- 4 **DIGITAL/ANALOG**

Press to switch between digital and analogue mode.
- 5 – **Wide Mode**

Changes the picture size. Press repeatedly to select the desired wide mode (page 10).
- 6 **SCENE – Scene Select mode**

Press to display the “Scene Select” menu. When you select the desired scene option, the optimum sound and picture quality for selected scene are automatically set. The options you can select may vary. Unavailable options are greyed out.

 - “**Auto**”: Delivers optimum picture and sound quality which is automatically set according to input source. There may not be any effect depending on the connected equipments.
 - “**General**”: Current user settings.
 - “**Photo**”: Delivers picture that reproduces the texture and colour of a printed photo.
 - “**Music**”: Delivers dynamic and clear sound effects like at a concert.
 - “**Cinema**”: Delivers theatre-like picture and dynamic sound.
 - “**Game**”: Delivers the best picture and sound quality for fullest game playing enjoyment.
 - “**Graphics**”: Delivers clearer detailed pictures to reduce fatigue for prolonged viewing.
 - “**Sports**”: Delivers realistic picture with surround sound like in a stadium.
- 7 **GUIDE (EPG)**

Press to display the Digital Electronic Programme Guide (EPG) (page 16).
- 8 **RETURN**
 - Returns to the previous screen of any displayed menu.
 - When playing a photo/music/video file: Press to stop the playback (the display returns to the file or thumbnail view).
- 9 **HOME**

Displays or cancels the menu.
- 10 **Number buttons**
 - Selects channels. For channel numbers 10 and above, enter the next digit quickly.
 - In Text mode: Enters the three digit page number to select the page.
- 11 – **Text**

In Text mode: Displays Text broadcast.
Each time you press , the display changes cyclically as follows:
Text → Text over the TV picture (mix mode) → No Text (exit the Text service)
- 12 – **Volume**

Adjusts volume.
- 13 – **Mute**

Press to mute the sound. Press again to restore the sound.
- 14 – **TV standby**

Press to turn the TV on or to switch to standby mode.
- 15 **AUDIO – Dual Sound (page 23)**

Continued

- 16** – **Info / Text reveal**
- Displays information. Press once to display information about the programme/ input you are viewing. Press again to remove the display from the screen.
 - In Text mode: Reveals hidden information (e.g. answers to a quiz).
- 17** – **Item select / Enter**
- Selects or adjusts items.
 - Confirms selected items.
 - When playing a photo file: Press to select the previous file. Press to select the next file.
 - When playing a music/video file: Press to pause/start the playback. Press and hold to fast forward/fast reverse, then release the button at the point where you want to resume playback.
- 18** **OPTIONS**
- Press to display a list that contains shortcuts to some setting menus. The listed options vary depending on the current input and content.
- 19** **Coloured buttons**
- When the coloured buttons are available, an operation guide appears on the screen.
- 20** – **Subtitle setting**
- Press to change the subtitle language (page 27) (in digital mode only).
- 21** **PROG/CH +/-/⏪/⏩**
- Selects the next (+) or previous (-) channel.
 - In Text mode: Selects the next (⏪) or previous (⏩) page.
- 22** – **Previous channel**
- Returns to the previous channel or input watched (for more than 15 seconds).

To change the Wide Mode

For TV, Video, Component or HDMI (except PC input)

Wide Zoom* 	Enlarges the centre portion of the picture. The left and right edges of the picture are stretched to fill the 16:9 screen.
Normal 	Displays the 4:3 picture in its original size. Side bars are shown to fill the 16:9 screen.
Full 	Stretches the 4:3 picture horizontally to fill the 16:9 screen.
Zoom* 	Displays cinematic (letter box format) broadcasts in the correct proportions.
14:9* 	Displays 14:9 broadcasts in the correct proportions. As a result, black border areas are visible on the screen.

* Parts of the top and bottom of the picture may be cut off.

- You cannot select “Normal” or “14:9” for HD signal source pictures.

PC or HDMI PC Input (PC timing)

Normal 	Displays the picture in its original pixel size. Bars are shown at the top, bottom, and both sides for small picture.
Full 1 	Stretches the original picture to fill the screen vertically, keeping its original horizontal-to-vertical aspect ratio.
Full 2 	Stretches the Full 1 picture horizontally to fill the 16:9 screen.

- Some options may not be available depending on the PC input signal.

Overview of the TV buttons and indicators

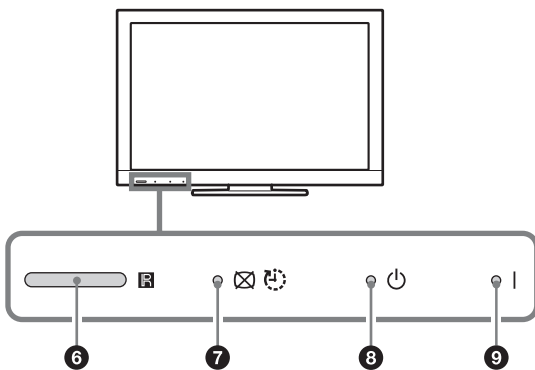
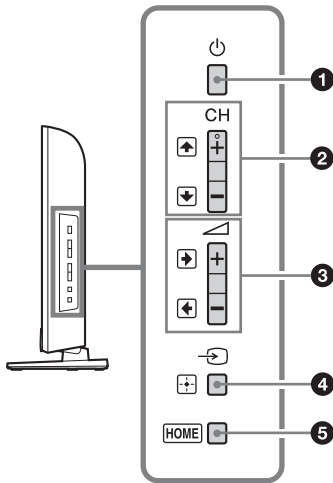

- 1** – **Power**
 Press to turn the TV on or to switch to standby mode.
 - To disconnect the TV from the AC power completely, pull the plug from the AC power outlet.
 - 2** **CH +/-**
 • Selects the next (+) or previous (–) channel.
 • In TV menu: Moves through the options up () or down ().
 - 3** **+/-**
 • Increases (+) or decreases (–) the volume.
 • In TV menu: Moves through the options right () or left ().
 - 4** – **Input select / Enter**
 • Displays the connected equipment list and selects the input source (page 13).
 • In TV menu: Selects the menu or option, and confirms the setting.
 - 5** **HOME**
 Displays or cancels the menu.
 - 6** – **Remote sensor / Light sensor**
 Receives IR signals from the remote. Senses room light level and adjusts the screen brightness accordingly. Do not put anything over the sensor, doing so may affect its function.
 - 7** – **Picture Off / Timer indicator**
 Lights up in green when you select “Picture Off” (page 30).
 - 8** – **Standby indicator**
 Lights up in red when the TV is in standby mode.
 - 9** – **Power indicator**
 • Lights up in green when the TV is turned on.
 • Flashes while the remote is being operated.
- Make sure that the TV is completely turned off before unplugging the AC power cord. Unplugging the AC power cord while the TV is turned on may cause the indicator to remain lit or may cause the TV to malfunction.
- The **CH +** button has a tactile dot. Use it as a reference when operating the TV.

Using Optional Equipment

Connecting optional equipment

You can connect a wide range of optional equipment to your TV.

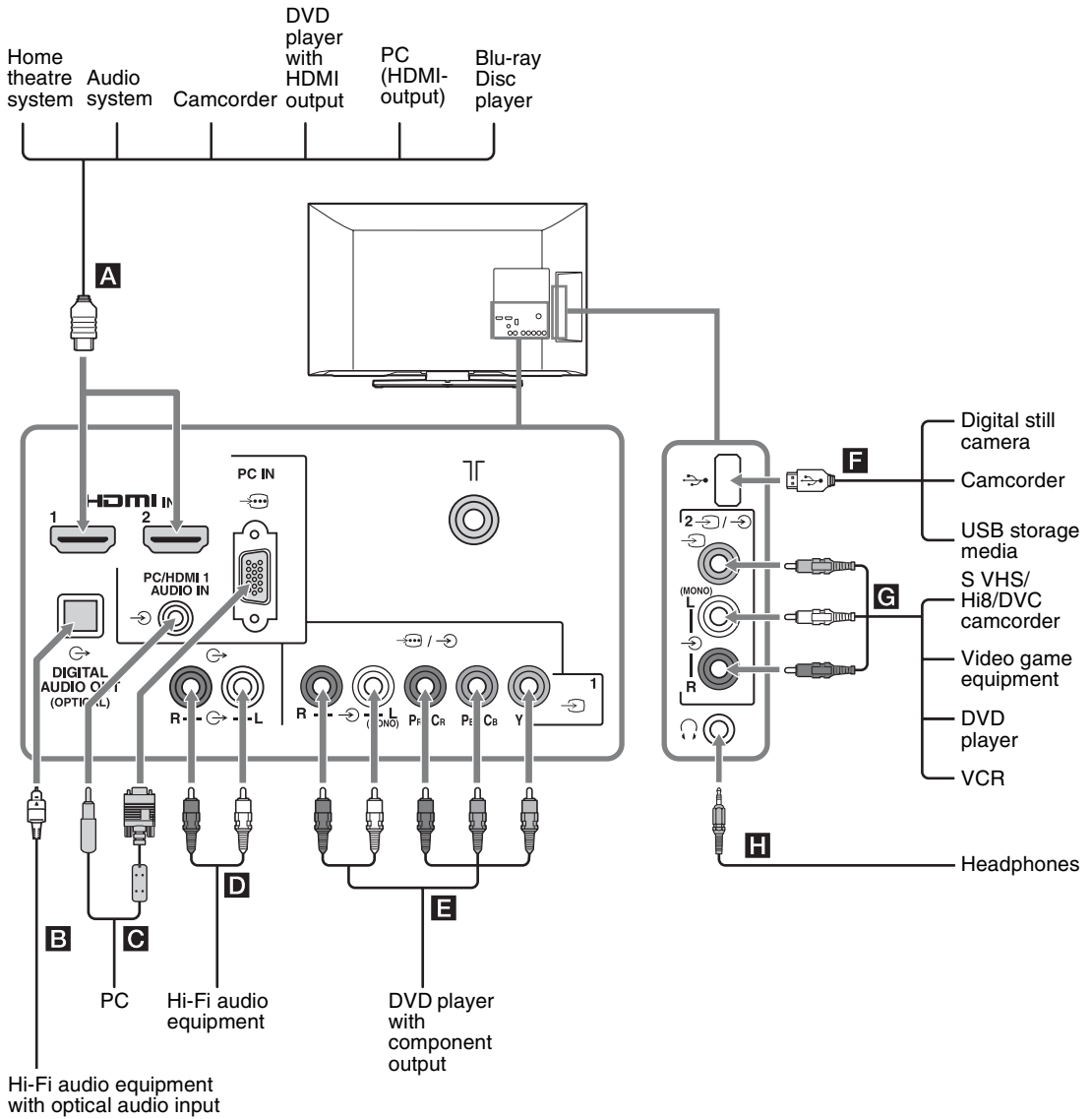

Viewing pictures from the connected equipment

Turn on the connected equipment, then press / to display the connected equipment list. Press / to select the desired input source, then press . (The highlighted item is selected if 2 seconds pass without any operation after pressing /.) When the input source is set to "Skip" in the "Video Labels" under the "AV Set-up" menu (page 29), that input is greyed out in the list.

- Press / on the TV to display the connected equipment list and select the desired input source. You can also press / to select the desired input source. Then wait for 2 seconds to display the selected input source.

Jacks/ Input symbol on screen	Description
A HDMI IN 1 or 2 HDMI 1 or HDMI 2	<p>Connect to the HDMI IN 1 or 2 jack if the equipment has an HDMI jack. The digital video and audio signals are input from the equipment.</p> <p>In addition, when you connect the equipment that is compatible with Control for HDMI, communication with the connected equipment is supported. See page 30 to set up this communication.</p> <p>If the equipment has a DVI jack, connect the DVI jack to the HDMI IN 1 jack through a DVI - HDMI adaptor interface (not supplied), and connect the equipment's audio out jack to the PC/HDMI 1 AUDIO IN jack in the PC IN jacks (the PC/HDMI 1 AUDIO IN jack is used as the audio in jack for both the PC IN and HDMI IN 1 jacks).</p> <ul style="list-style-type: none"> • The HDMI jacks only support the following video inputs: 480i, 480p, 576i, 576p, 720p, 1080i, 1080p and 1080/24p. • The HDMI jacks can support PC timing in HDMI PC mode. See page 25 for supported PC input signal. • Be sure to use only an authorized HDMI cable bearing the HDMI logo. We recommend that you use a Sony HDMI cable (high speed type).
B DIGITAL AUDIO OUT (OPTICAL)	Use an optical audio cable.
C PC IN / PC	Connect to the PC IN jack and the audio jack . It is recommended to use a PC cable with ferrite core.
D	You can listen to TV sound on the connected Hi-Fi audio equipment.
E / or Component or Video 1	<p>Connect to the component jacks and the audio jacks /. For better picture quality, component connection is recommended if your DVD player has a component video output. When using the component video jack as the video jack 1, select "Video 1" in the "Video 1/Component Input" menu (page 29).</p> <ul style="list-style-type: none"> • You cannot use the component video jack and the video jack 1 at the same time.
F	You can enjoy photo/music/video files stored in a Sony digital still camera, camcorder or USB storage device (page 17).
G / 2 Video 2	Connect to the video jack 2 and the audio jacks 2. If you connect mono equipment, connect to the L (MONO) jack 2.
H Headphones	You can listen to TV sound through headphones.

Viewing PIP (Picture in Picture)

You can view two pictures (in PC input mode) on the screen simultaneously.

Connect a PC (page 12), and make sure that images from a PC appear on the screen (page 13).

1 Press **OPTIONS** and select “PIP”.

Two pictures are displayed simultaneously.



PIP Availability

In Main Window	In Sub Window
PC HDMI 1/2 (PC timing)	TV programme, HDMI 1/2 (for PC only) or Video 1/2

2 In sub window, you can select the TV channel or video input by pressing **OPTIONS** and select “Sub window”.

To return to single picture mode

Press **RETURN** or select “Single Picture” from Options menu.

- You cannot display resolutions higher than your TV's display resolution (page 36).
- In PIP mode, as picture size reduced, this may decrease picture smoothness.
- You can switch the audible picture by selecting “Audio Swap” from the Options menu.
- You can also use the PIP feature by selecting “PIP” from the Options menu.

Using Menu Functions

Navigating through menus

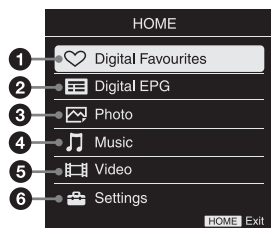

The **HOME** button allows you to access a variety of TV settings and USB media files.

- 1 Press **HOME** on the TV or remote.
- 2 Press \uparrow/\downarrow to select an option, then press \oplus .
- 3 Follow the instructions on the screen.
- 4 To exit the menu, press **HOME**.

Menu	Description
1 Digital Favourites	You can select the Digital Favourite list.
2 Digital EPG	You can select the Digital Electronic Programme Guide (EPG) (page 16).
3 Photo	You can enjoy photo files via USB devices (page 17).
4 Music	You can enjoy music files via USB devices (page 17).
5 Video	You can enjoy video files via USB devices (page 17).
6 Settings	Displays the “Settings” menu where most of the advanced settings and adjustments are performed. For details about settings, see page 21 to 30.

Using the Digital Favourite list **DVB***

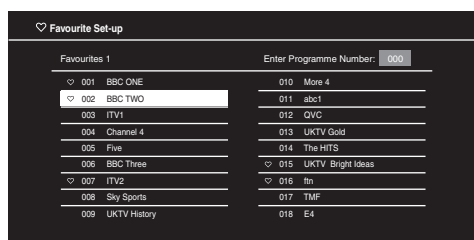

The Favourite feature allows you to specify up to four lists of your favourite programmes.

- 1 In digital mode, press **HOME** and select “Digital Favourites”.
- 2 Perform the desired operation as shown in the following table or displayed on the screen.

Digital Favourite list

* This function may not be available in some countries/regions.

To	Do this
Create your Favourite list for the first time	<ol style="list-style-type: none"> 1 Press \oplus to select “Yes”. 2 Press the yellow button to select the Favourite list. 3 Press $\uparrow/\downarrow/\leftarrow/\rightarrow$ to select the channel you want to add, then press \oplus. Channels that are stored in the Favourite list are indicated by a \heartsuit symbol. 4 Press RETURN to finish setting up.
Watch a channel	<ol style="list-style-type: none"> 1 Press the yellow button to navigate through your Favourite lists. 2 Press \uparrow/\downarrow to select the channel, then press \oplus.
Turn off the Favourite list	Press RETURN .

Continued

To	Do this
Add or remove channels in the currently edited Favourite list	<ol style="list-style-type: none"> 1 Press the blue button. 2 Press the yellow button to select the Favourite list you want to edit. 3 Press $\uparrow/\downarrow/\leftarrow/\rightarrow$ to select the channel you want to add or remove, then press \oplus.
Remove all channels from the current Favourite list	<ol style="list-style-type: none"> 1 Press the blue button. 2 Press the yellow button to select the Favourite list you want to edit. 3 Press the blue button. 4 Press \leftarrow/\rightarrow to select "Yes", then press \oplus to confirm.

Using the Digital Electronic Programme Guide (EPG) DV3*

GUIDE	Fri. 16. Mar 11:35			
	11:30	12:00	12:30	13:00
001 BBC ONE	Homes Under the Hammer	Neighbours	Atteridge	
002 BBC TWO	Ready Steady Cook	Extraordinary People: Britains Id...	CSI: Crime Scene Inv...	
003 ITV1	Dancing On Ice Exclusive		Cracker	
004 Channel 4	Sign Zone: Ancient Rome: The Rise a...	The Jeremy Kyle...	Homes Under Th...	
005 Five	House	Law and Order: Special Victims U...	PartyPoker.com Wor...	
006 ITV2	Crime Hour: Midsomer Murders		Vodafone TBA: L...	
007 BBC THREE	BBC Learning Zone: Schools: World P...	A Picture of Brit...	Eastenders	
008 BBC FOUR	ER	Real Crime: The Truth: About the...	This is BBC FOUR	
009 ITV3		Everybody Loves Raymond	The Sharon Osb...	
010 SKY THREE	Racing from Chepstow and Ascot	Baseball Wedne...	Trans World Sport	
011 More 4	Carry On Up The Khyber			

- 1 In digital mode, press **GUIDE**.
- 2 Perform the desired operation as shown in the following table or displayed on the screen.

Digital Electronic Programme Guide (EPG)

* This function may not be available in some countries/regions.

To	Do this
Watch a programme	Press $\uparrow/\downarrow/\leftarrow/\rightarrow$ to select the programme, then press \oplus .
Turn off the EPG	Press GUIDE .



- If an age restriction for programmes has been selected, a message asking for a PIN code will appear on the screen. For details, see "Parental Lock" on page 28.

Playing back photo/music/video via USB

You can enjoy photo/music/video files stored in a Sony digital still camera or camcorder through a USB cable or USB storage device on your TV.

- 1 Connect a supported USB device to the TV.
 - 2 Press **HOME**.
 - 3 Press \swarrow/\searrow to select “Photo”, “Music” or “Video”.
 - 4 The thumbnail view of file or folder appears.
If more than one USB device is detected, press the red button to select “Device Selection” from the list of available options and press \oplus , then press $\swarrow/\searrow/\swarrow/\searrow$ to select a USB device and press \oplus .
 - 5 Press $\swarrow/\searrow/\swarrow/\searrow$ to select a file or folder, then press \oplus .
When you select a folder, select a file, then press \oplus .
Playback starts.
-  • If you connect the USB device when “USB Auto Start” is set to “On” (page 29), the thumbnail view of the last played Photo/Music/Video appears automatically.

Basic operation of Photo/Music/Video

You can operate the connected USB device by the TV remote.

Item	Description
\ll / \gg	Fast reverses/fast forwards the file when pressed during playback.
\lll / \ggg	Goes to the beginning of the previous/ next file.
\blacktriangleright	Starts playback.
\parallel	Pauses playback.
\blacksquare	Stops playback.

-  • If a video file has subtitles, they can be displayed by pressing the green button during DivX playback.

To use playback options

Press the coloured buttons to display a list that contains shortcuts to some setting menus. The listed options vary depending on the current input and content.

Photo

“**Slideshow Effect**”: Selects an effect for a slideshow.

“**Slideshow Speed**”: Selects the slideshow duration.

“**Shuffle**”: Plays a file in random order.

“**Zoom**”*: Magnifies the picture (“1x”, “2x” or “4x”)

Music

“**Playback Target**”: Selects to play all files, or one selected file.

“**Shuffle**”: Plays files in random order.

“**Speakers**”: Selects a speaker (page 23).

Video

“**Playback Target**”: Selects to play all files, or one selected file.

“**Zoom**”*: Magnifies the picture (“1x”, “2x”, “4x” or “Full”)

“**Speakers**”: Selects a speaker (page 23).

* When you set “Zoom”, stop video playback.

General

“**Repeat**”: Plays a file repeatedly.

“**File Order**”: Changes file order

“**Device Selection**”: Selects a USB device.

Continued

To set the picture (Video)

You can adjust the picture quality of USB Video.

- 1 Select a video.
See “Playing back photo/music/video via USB” (page 17).
- 2 Press **OPTIONS** during playback, then press \leftarrow/\rightarrow to select “Picture” and press \oplus .
- 3 Press $\leftarrow/\rightarrow/\leftarrow/\rightarrow$ to select the item, then press \oplus .
- 4 Press $\leftarrow/\rightarrow/\leftarrow/\rightarrow$ to adjust the setting, then press \oplus .

To play a photo as a slideshow (Photo)

You can play a slideshow with photos. “Slideshow Effect” and “Slideshow Speed” can be set.

- 1 Select a photo.
See “Playing back photo/music/video via USB” (page 17).
- 2 Press the green button in thumbnail view, or press **OPTIONS** while a photo is displayed, then press \leftarrow/\rightarrow to select “Slideshow” and press \oplus .

To stop a slideshow

Press **RETURN** or **HOME**.

- While the TV is accessing the data on the USB device, observe the following:
 - Do not turn off the TV or connected USB device.
 - Do not disconnect the USB cable.
 - Do not remove the USB device.The data on the USB device may be damaged.
- Sony will not be held liable for any damage to, or loss of, data on the recording media due to a malfunction of any connected devices or the TV.
- The file name and folder name may not display correctly in some cases.
- When you connect a Sony digital still camera, set the camera’s USB connection mode to Auto or Mass Storage. For more information about USB connection mode, refer to the instructions supplied with your digital camera.
- Check the website below for updated information about compatible USB devices.
<http://www.sony-asia.com/bravia/flash.html>
- Use a USB storage device that is compliant with USB mass storage device class standards.
- If a selected file has incorrect container information, or is incomplete, it cannot be played back.
- BRAVIA TV supports DivX®.

USB Video format

Extension	Container	Video Codec	Audio Codec
.avi	AVI	DivX 3.11/4.x/5.1	PCM / MPEG1 Layer1, 2 / MP3 / MPEG2 AAC (2ch) / MPEG4 AAC (2ch) / MPEG4 HE-AAC (2ch) / Dolby Digital (2ch) / WMA v8
		XviD	
		MPEG1	
		MPEG2 MP	
		H.264 BP/MP/HP	
		MPEG-4 SP/ASP	
.wmv .asf	ASF	WMV v9	MP3 / WMA v8
		Divx 3.11	
		XviD	
		MPEG-4 SP/ASP	
		VC-1	
.mp4 .mov .3gp	MP4	H.264 BP/MP/HP	MPEG1 Layer1, 2 / MP3 / MPEG2 AAC / MPEG4 AAC / MPEG4 HE-AAC
		MPEG-4 SP/ASP	
		H.263	
.mkv	MKV	H.264 BP/MP/HP	PCM / MPEG1 Layer1, 2 / MP3 / MPEG2 AAC (2ch) / MPEG4 AAC (2ch) / MPEG4 HE-AAC (2ch) / Dolby Digital (2ch) / WMA v8
		MPEG-4 SP/ASP	
		WMV v9	
		DivX 3.11/4.x/5.1	
		VC-1	
.mpg .mpeg .vob	PS	MPEG1	MPEG1 Layer1, 2 / MP3 / Dolby Digital (2ch)
		MPEG2 MP	
.ts, .m2ts	TS	MPEG2 MP	MPEG1 Layer1, 2 / MP3 / MPEG2 AAC / MPEG4 AAC / MPEG4 HE-AAC
		VC-1	
		H.264 BP/MP/HP	

USB Music format

Extension	Audio Codec
.mp3	MP3
.wma	WMA v8

USB Photo format

Extension	Image Codec
.jpg, .jpeg	JPEG

DCF2.0 or EXIF2.21 supported.

 • Playback of the above file formats is not guaranteed.

Using BRAVIA Sync with Control for HDMI

The Control for HDMI function enables the TV to communicate with the connected equipment that is compatible with the function, using HDMI CEC (Consumer Electronics Control). For example, by connecting Sony equipment that is compatible with Control for HDMI (with HDMI cables), you can control them together. Be sure to connect the equipment correctly, and make the necessary settings.

Control for HDMI

- Automatically turns the connected equipment off when you switch the TV to standby mode using the remote.
- Automatically turns the TV on and switches the input to the connected equipment when the equipment starts to play.
- If you turn on a connected audio system while the TV is on, the sound output switches from the TV speaker to the audio system.
- Adjusts the volume (◀ +/-) and mutes the sound (⊗) of a connected audio system.
- You can operate the connected Sony equipment that has the BRAVIA Sync logo by the TV remote. Possible operations with BRAVIA Sync buttons, see page 9.
 - Refer to the instruction manual of the equipment for available control.
- If “Control for HDMI” of the TV is set to “On”, “Control for HDMI” of the connected equipment is also automatically switched to “On”.



To make the Control for HDMI settings

The Control for HDMI settings must be set on both the TV side and connected equipment side. See “HDMI Set-up” (page 30) for the TV side settings. For settings on the connected equipment, refer to its operating instructions.

Settings adjustment

 • The options you can adjust vary depending on the situation. Unavailable options are greyed out or not displayed.



Picture

Picture Mode	Sets a picture mode. The options that can be selected differ depending on the “Scene Select” settings. “ Vivid ”: Enhances picture contrast and sharpness. “ Standard ”: For standard pictures. Recommended for home entertainment. “ Custom ”: Allows you to store your preferred settings. “ Cinema ”: For film-based content. Suitable in a theatre-like environment. “ Photo ”: For standard viewing of photographs. “ Sports ”: Optimizes picture quality for viewing sports. “ Game ”: Select for standard picture suitable for games. “ Graphics ”: Optimizes picture quality for viewing graphics.
Reset	Resets all the “Picture” settings except “Picture Mode” to the factory settings.
Backlight	Adjusts the brightness of the backlight.
Picture	Increases or decreases picture contrast.
Brightness	Brightens or darkens the picture.
Colour	Increases or decreases colour intensity.
Hue	Increases or decreases the green tones and red tones.  • When viewing TV programme or video input, “Hue” is only available for NTSC colour system.
Sharpness	Sharpens or softens the picture.
Colour Temperature	Adjusts the whiteness of the picture. “ Cool ”: Gives the white colours a blue tint. “ Neutral ”: Gives the white colours a neutral tint. “ Warm ”: Gives the white colours a red tint.  • “Warm” is not available when “Picture Mode” is set to “Vivid”.
Noise Reduction	Reduces the picture noise (snowy picture) in a weak broadcast signal.
MPEG Noise Reduction	Reduces the picture noise in MPEG-compressed video.
Cinema Drive	Provides improved picture movement when playing BD (Blu-ray Disc), DVD or VCR images taken on film, reducing picture blur and graininess. Select “Auto” to represent original film-based content as is.  • If the image contains irregular signals or too much noise, “Cinema Drive” is automatically turned off even if “Auto” is selected.

Advanced Settings	<p>Allows you to set “Picture” settings in more detail. These settings are not available when “Picture Mode” is set to “Vivid”.</p> <p>“Reset”: Resets all the advanced settings to the factory settings.</p> <p>“Adv. Contrast Enhancer”: Automatically adjusts “Backlight” and “Picture” to the most suitable settings judging from the brightness of the screen. This setting is especially effective for dark images scenes, and will increase the contrast distinction of the darker picture scenes.</p> <p>“Black Corrector”: Enhances black areas of the picture for stronger contrast.</p> <p>“Gamma”: Adjusts the balance between bright and dark areas of the picture.</p> <p>“Clear White”: Emphasises white colours.</p> <p>“Live Colour”: Makes colours more vivid.</p>
--------------------------	--





Sound

Sound Mode	<p>Sets a sound mode. The options that can be selected differ depending on the “Scene Select” settings.</p> <p>“Dynamic”: Enhances treble and bass. Recommended for home entertainment.</p> <p>“Standard”: For standard sound.</p> <p>“Clear Voice”: Makes voice sound clearer.</p>
Reset	<p>Resets all the “Sound” settings except “Sound Mode”, “Dual Sound”, “Speakers”, “Audio Out”, “Headphone Speaker Link”, “Headphone Volume” and “HDMI/DVI Audio Source” to the factory settings.</p>
7 Band Equalizer	<p>Adjusts sound frequency settings.</p> <p>Press ⇄ to select the desired sound frequency, then press ⇄ to adjust the setting and press ⊕. The adjusted settings will be received when you select “Sound Mode” options. Selecting “Reset” will set the “7 Band Equalizer” to original settings.</p> <p> • Adjusting higher frequency will affect higher pitched sound and adjusting lower frequency will affect lower pitched sound.</p>
Balance	<p>Emphasises left or right speaker balance.</p>
Intelligent Volume	<p>Minimizes the difference in volume level between all programmes and adverts (e.g. adverts tend to be louder than programmes).</p>
Volume Offset	<p>Adjusts the volume level of the current input relative to other inputs.</p>
Surround	<p>Allows you to select the suitable surround effects depending on the genre of TV programme (movie, sport, music, etc.) or video game.</p> <p>The options that can be selected differ depending on the “Scene Select” settings.</p> <p>“On”: Delivers surround effects that help you enjoy the virtual two-ch surround audio with just the two internal TV speakers.</p> <p>“Simulated Stereo”: Adds a surround-like effect to mono programmes.</p> <p>“Cinema”: Delivers surround effects just like the high-grade audio systems found in movie theatres.</p> <p>“Music”: Delivers surround effects that make you feel like you are surrounded by sound as in a music hall.</p> <p>“Sports”: Delivers surround effects that make you feel like you are watching a live sports contest.</p> <p>“Game”: Delivers surround effects that enhance game sound.</p> <p>“Off”: Converts and reproduces multi-ch audio to 2ch audio. In the case of other audio formats, the original audio is reproduced.</p>
Bass Booster	<p>Produces a fuller sound for more impact, by emphasising the bass sounds.</p>

Dual Sound	<p>Sets the sound from the speaker for a stereo or bilingual broadcast.</p> <p>“Stereo”/“Mono”: For stereo broadcasts.</p> <p>“Main”/“Sub”/“Mono”: For bilingual broadcasts, select “Main” for sound channel 1, “Sub” for sound channel 2, or “Mono” for mono channel, if available.</p> <p> • If the signal is very weak, the sound becomes monaural automatically.</p> <ul style="list-style-type: none"> • If the stereo sound is noisy when receiving a NICAM programme, select “Mono”. The sound becomes monaural, but the noise is reduced. • The “Dual Sound” setting is memorized for each programme position. • You cannot listen to stereo broadcast sound when “Mono” is selected. <p> • If you select other equipment connected to the TV, set “Dual Sound” to “Stereo”, “Main” or “Sub”. However, when the external equipment connected to the HDMI jack (except HDMI 1) is selected, this is fixed to “Stereo”.</p>
Speakers	<p>“TV Speakers”: Turns on and outputs the TV’s sound from the TV speakers.</p> <p>“Audio System”: Turns off the TV speakers and outputs the TV’s sound from external audio equipment connected to the audio output jacks on the TV.</p> <p>You can also turn on the connected equipment that is compatible with Control for HDMI, after making the appropriate settings of Control for HDMI.</p>
Audio Out	<p>“Variable”: When using an external audio system, volume output from audio out can be controlled using the TV’s remote.</p> <p>“Fixed”: The audio output of the TV is fixed. Use your audio receiver’s volume control to adjust the volume (and other audio settings) through your audio system.</p>
Headphone Speaker Link	Switches the TV’s internal speakers on/off when you connect headphones to the TV.
Headphone Volume	Adjusts the volume of the headphones.
HDMI/DVI Audio Source	Switches the audio signal for HDMI input when a DVI device is connected. Select from “Auto”, “HDMI Audio” and “PC Audio”.
Advanced Settings	<p>“Dynamic Range”: Compensates for differences in the audio level between different channels (only for Dolby Digital audio).</p> <p> • The effect may not function or may vary depending on the programme regardless of the “Dynamic Range” setting.</p> <p>“Optical Out”: Sets the audio signal that is output from the DIGITAL AUDIO OUT (OPTICAL) jack of the TV. Set to “Auto”, when connecting equipment compatible with Dolby Digital. Set to “PCM”, when connecting equipment not compatible with Dolby Digital.</p> <p>“Downmix Mode”: Set the downmix method of multi-channel to two-channel sound.</p> <ul style="list-style-type: none"> • “Surround”: Select to get best surround performance, or while using external products with Pro Logic. • “Stereo”: Select to get a stereo output.



Screen

Wide Mode	For details about wide mode, see page 10.
Auto Wide	Automatically changes the wide mode according to the input signal from an external equipment. To keep your setting, select “Off”.  • “Auto Wide” is only available when watching programmes from video input, HDMI and component input in format 480i or 576i.  • Even if “Auto Wide” is set to “On” or “Off”, you can always modify the format of the screen by pressing  repeatedly.
4:3 Default	Selects the default screen mode for use with 4:3 broadcasts. “Wide Zoom” : Enlarges the 4:3 picture to fill the 16:9 screen, keeping the original image as much as possible. “Normal” : Displays conventional 4:3 broadcasts in the correct proportions. “Off” : Keeps the current “Wide Mode” setting when the channel or input is changed.
Auto Display Area	“On” : Automatically adjusts the display area based upon the content. “Off” : Turns off the “Auto Display Area”. Choose one from the “Display Area” options.
Display Area	Adjusts the picture display area. “Full Pixel” : Displays the picture for 1080/50i, 1080/60i, 1080/50p and 1080/60p sources (HDMI or component input only) or 1080/24p sources (HDMI input only) in the original size. (Available depending on the TV model.) “+1” : Displays pictures in their original size. “Normal” : Displays pictures in their recommended size. “-1” : Enlarges the picture so that the edges are outside the visible display area.
Horizontal Shift	Adjusts the horizontal position of the picture when “Wide Mode” is set to “Wide Zoom” or “Zoom”.
Vertical Shift	Adjusts the vertical position of the picture when “Wide Mode” is set to “Wide Zoom” or “Zoom”.
PC Settings	“Wide Mode” Selects a screen mode for displaying input from your PC, see page 10. “Reset” Resets all the “PC Settings” except “Wide Mode” to the factory settings. “Auto Adjustment” Automatically adjusts the display position, phase and pitch of the picture when the TV receives an input signal from the connected PC.  • “Auto Adjustment” may not work well with certain input signals. In such cases, manually adjust “Phase”, “Pitch”, “Horizontal Shift” and “Vertical Shift”. “Phase” Adjusts the phase when the screen flickers. “Pitch” Adjusts the pitch when the picture has unwanted vertical stripes. “Horizontal Shift” Adjusts the horizontal position of the picture. “Vertical Shift” Adjusts the vertical position of the picture.

PC input signal reference chart for  PC and HDMI IN 1, 2**For KDL-32BX320/KDL-26BX320/KDL-22BX320**

Signals	Horizontal (Pixel)	Vertical (Line)	Horizontal frequency (kHz)	Vertical frequency (Hz)	Standard
VGA	640	480	31.5	60	VGA
SVGA	800	600	37.9	60	VESA Guidelines
XGA	1024	768	48.4	60	VESA Guidelines
WXGA	1280	768	47.4	60	VESA
WXGA	1280	768	47.8	60	VESA
WXGA	1360	768	47.7	60	VESA

For KDL-40BX420

Signals	Horizontal (Pixel)	Vertical (Line)	Horizontal frequency (kHz)	Vertical frequency (Hz)	Standard
VGA	640	480	31.5	60	VGA
SVGA	800	600	37.9	60	VESA Guidelines
XGA	1024	768	48.4	60	VESA Guidelines
WXGA	1280	768	47.4	60	VESA
WXGA	1280	768	47.8	60	VESA
WXGA	1360	768	47.7	60	VESA
SXGA	1280	1024	64	60	VESA
HDTV	1920	1080	67.5	60	EIA

-  This TV's PC input does not support Sync on Green or Composite Sync.
- This TV's PC input does not support interlaced signals.
- This TV's PC input supports signals in the above chart with a 60 Hz vertical frequency.

Analogue Set-up

“Analogue Auto Tuning”: Tunes in all the available analogue channels. Usually you do not need to do this operation because the channels are already tuned when the TV was first installed. However, this option allows you to repeat the process (e.g., to retune the TV after moving house, or to search for new channels that have been launched by broadcasters).

“Manual Programme Preset”: Changes the available analogue channel setting. Press ⊕ to select the programme you want to modify.

Programme/TV System

Presets programme channels manually.

1 Press ⬆/⬇ to select “Programme”, then press ⊕.

2 Press ⬆/⬇ to select the programme number you want to manually tune (if tuning a VCR, select programme 0), then press ⊕.

3 Press ⬆/⬇ to select “TV System”, then press ⊕.

4 Press ⬆/⬇ to select the best received TV broadcast systems, then press ⊕.

 • Depending on the country/region selected for “Country”, this option may not be available.

Channel

1 Press ⬆/⬇ to select “Channel”, then press ⊕.

2 Press ⬆/⬇ to select “S” (for cable channels) or “C” (for terrestrial channels), then press ⇨.

3 Tune the channels as follows:

If you do not know the channel number (frequency)

Press ⬆/⬇ to search for the next available channel. When a channel has been found, the search will stop. To continue searching, press ⬆/⬇.

If you know the channel number (frequency)

Press the number buttons to enter the channel number of the broadcast you want or your VCR channel number.

4 Press ⊕ to jump to “Confirm”, then press ⊕.

Repeat the procedure above to preset other channels manually.

Label

Assigns a name of your choice, up to seven letters or numbers, to the selected channel.

AFT

Allows you to fine-tune the selected programme number manually if you feel that a slight tuning adjustment will improve the picture quality.

Audio Filter

Improves the sound for individual channels in the case of distortion in mono broadcasts. Sometimes a non-standard broadcast signal can cause sound distortion or intermittent sound muting when watching mono programmes.

If you do not experience any sound distortion, we recommend that you leave this option set to the factory setting “Off”.

Skip

Skips unused analogue channels when you press **PROG +/-** to select channels. (You can still select a skipped channel using the number buttons.)

Confirm

Saves changes made to the “Manual Programme Preset” settings.

“Programme Sorting”: Changes the order in which the analogue channels are stored on the TV.

1 Press ⬆/⬇ to select the channel you want to move to a new position, then press ⇨.

2 Press ⬆/⬇ to select the new position for your channel, then press ⊕.

Digital Set-up

“Digital Tuning”

- **“Digital Auto Tuning”:**

Tunes in the available digital channels.

This option allows you to retune the TV after moving house, or to search for new channels that have been launched by broadcasters. Press ⊕.

- **“Programme List Edit”:**

Removes any unwanted digital channels stored on the TV, and changes the order of the digital channels stored on the TV.

1 Press \uparrow/\downarrow to select the channel you want to remove or move to a new position.

Press the number buttons to enter the known three-digit programme number of the broadcast you want.

2 Remove or change the order of the digital channels as follows:

To remove the digital channel

Press ⊕. After a confirmation message appears, press \leftarrow to select “Yes”, then press ⊕.

To change the order of the digital channels

Press \rightarrow , then press \uparrow/\downarrow to select the new position for the channel and press \leftarrow .

3 Press RETURN.

- **“Digital Manual Tuning”:**

Tunes the digital channels manually.

1 Press the number button to select the channel number you want to manually tune, then press \uparrow/\downarrow to tune the channel.

2 When the available channels are found, press ⊕ to store programmes.

Repeat the above procedure to manually tune other channels.

∇ • Not available for Cable connection.

“Subtitle Set-up”

- **“Subtitle Setting”:** When “For Hard Of Hearing” is selected, some visual aids may also be displayed with the subtitles (if TV channels broadcast such information).

- **“Primary Preferred Language”:** Selects preferred language which subtitles are displayed in.

- **“Secondary Preferred Language”:** Selects secondary preferred language which subtitles are displayed in.

“Audio Set-up”

- **“Audio Type”:** Switches to broadcast for the hearing impaired when “For Hard Of Hearing” is selected.

- **“Primary Preferred Language”:** Selects the preferred language used for a programme. Some digital channels may broadcast several audio languages for a programme.

- **“Secondary Preferred Language”:** Selects the secondary preferred language used for a programme. Some digital channels may broadcast several audio languages for a programme.

- **“Audio Description”:** Provides audio description (narration) of visual information if TV channels broadcast such information.

- **“Mixing Level”:** Adjusts the TV main audio and Audio Description output levels.

- \odot • This option is only available when “Audio Description” is set to “On”.

- **“MPEG Audio Level”:** Adjusts the MPEG audio sound level.

Continued

“Technical Set-up”

- **“Auto Service Update”**: Enables the TV to detect and store new digital services as they become available.
- **“System Update”**: This TV set is capable of receiving software upgrades via the broadcast signal. In order to receive upgrades the System Update option in the Technical Setup menu should be set to “On”. When an upgrade is detected the user will be informed by a series of on screen displays on how to proceed with the upgrade. Please do not disconnect the set from the mains during the installation procedure.
- **“System Information”**: Displays the current software version and the signal level.
- **“Auto DST”**: Sets whether or not to automatically switch between summer time and winter time.
“On”: Automatically switches between summer time and winter time according to the calendar.
“Off”: The time is displayed according to the time difference set by “Time Zone”.
• When “Cable” is selected this function may not be available in some countries.
- **“Service Replacement”**: Select “On” to automatically change the channel when broadcaster changes transmission of the viewing programme to a different channel.

Parental Lock

PIN Code	Allows you to set up TV to block channel or external input. Use 0-9 on the remote to enter a four-digit PIN code.
Change PIN Code	Selects to change your PIN code.
Parental Rating	Singaporean model: Sets an age restriction to viewing. To view any programme rated for ages above the age you specify, enter the correct PIN code. Australian model and New Zealand model: Sets a parental guidance level. Programmes that exceed the set level can only be watched after entering the correct PIN code.



(Australian model)

Level	Function
Block All	All programmes need a password to view.
G and above	To lock “General” and above programmes.
PG and above	To lock “Parental Guidance” and above programmes.
M and above	To lock “Mature” and above programmes.
MA and above	To lock “Mature Adult” and above programmes.
AV and above	To lock “Adult/Violence” and above programmes.
R and above	To lock “Restricted” and above programmes.
No block	No programmes need a password to view.











(New Zealand model)

Level	Function
Block All	All programmes need a password to view.
G and above	To lock “General” and above programmes.
PGR and above	To lock “Parental Guidance Recommended” and above programmes.
AO and above	To lock “Adults Only” and above programmes.
No block	No programmes need a password to view.

External Input Lock	Locks an external input from being watched. To view a blocked external input, select “Unblocked”.
----------------------------	--

 • Entering the correct PIN code for blocked channel or external input will temporarily deactivate the “Parental Lock” feature. To reactivate the “Parental Lock” settings, turn off and on the TV.
 • If you lost your PIN code, see page 35.

Set-up

USB Auto Start	Automatically enters the thumbnail view of the last played Photo/Music/Video when the TV is turned on and a USB device is connected to the USB port then turned on.
Sleep Timer	Set the time in minutes (“Off”, “15”, “30”, “45”, “60”, “90”, or “120”) that you would like the TV to remain on before shutting off automatically.
Auto Start-up	Starts the initial set-up procedure (page 6). This option allows you to retune the TV after moving house, or to search for new channels that have been launched by broadcasters.
Language	Selects the language in which the menus are displayed.
Start-up Sound	Select “On” to play sound when the TV is turned on. Select “Off” to disable it.
AV Set-up	<p>“Video Labels”</p> <p>Assigns a name to any equipment connected to the side and rear jacks. The name will be displayed briefly on the screen when the equipment is selected.</p> <p>1 Press  to select the desired input source, then press .</p> <p>2 Press  to select the desired option below, then press .</p> <p>Equipment labels: Uses one of the preset labels to assign a name to connected equipment.</p> <p>“Edit”: Creates your own label. Follow steps 2 to 3 of “Label” (page 26).</p> <p>“Skip”: Skips an unnecessary input source.</p> <p>“Video 1/Component Input”</p> <p>Select “Auto” to have the TV detect and switch between the component video jack  or the video jack  1 when component video jack  or video jack  1 is connected.</p> <p> • You cannot use the component video jack  and the video jack  1 at the same time.</p>

HDMI Set-up	<p>Allows the TV to communicate with equipment that is compatible with the Control for HDMI function, and connected to the HDMI jacks of the TV. Note that communication settings must also be made on the connected equipment.</p> <p>“Control for HDMI” Sets whether or not to link the operations of the TV and the connected equipment that is compatible with Control for HDMI. When set to “On”, the following functions are available.</p> <p>If the specific Sony equipment that is compatible with Control for HDMI is connected, this setting is applied to the connected equipment automatically when the “Control for HDMI” is set to “On” using the TV.</p> <p>“Auto Devices Off” When this is set to “On”, the connected equipment that is compatible with Control for HDMI turns off when you turn off the TV by remote.</p> <p>“Auto TV On” When this is set to “On”, the TV turns on when you turn on the connected equipment that is compatible with Control for HDMI.</p> <p>“HDMI Device List” Displays a list of connected equipment that is compatible with Control for HDMI. Selects “Enable” to update the “HDMI Device List”.</p> <p>“Device Control Keys” Select button functions of the TV’s remote control to operate the connected equipment. “Normal”: For basic operations, such as navigation buttons (up, down, left or right, etc). “Tuning Keys”: For basic operations and operation of channel-related buttons, such as PROG +/- or (0-9), etc. Useful when you control a tuner or set-top box, etc; via the remote control. “Menu Keys”: For basic operations and operation of the HOME/OPTIONS buttons. Useful when you select menus of a BD player, etc; via the remote control. “Tuning and Menu Keys”: For basic operations and operation of channel-related buttons and HOME/OPTIONS button.</p> <ul style="list-style-type: none"> 🔗 • You cannot use “Control for HDMI” if the TV operations are linked to the operations of an audio system that is compatible with Control for HDMI. • Some equipment with “Control for HDMI” does not support the “Device Control” feature.
DivX(R) VOD	<p>Select “DivX(R) VOD Registration Code” to register your TV for playback of DivX contents. Select “DivX(R) VOD Deregistration Code” to delete the registration.</p> <ul style="list-style-type: none"> 🔗 • A new registration code will be displayed in “DivX(R) VOD Registration Code” after deleting registration via “DivX(R) VOD Deregistration Code”.
Product Information	Displays your TV’s product information.
Factory Settings	<p>Resets all settings to factory settings. After completing this process, the initial set-up screen is displayed.</p> <ul style="list-style-type: none"> 🔗 • Be sure not to turn the TV off during this period (it takes about 30 seconds) or press any buttons.



Eco

Reset	Resets the current Eco settings to the default values.
Power Saving	<p>Reduces power consumption of the TV by adjusting the backlight.</p> <p>When you select “Picture Off”, the picture is switched off, and the  (Picture Off) indicator on the TV front panel lights up in green. The sound remains unchanged.</p>
Idle TV Standby	Turns the TV off after it has been kept idle for the preset length of time.
Light Sensor	Optimises the picture settings according to the ambient lighting.
PC Power Management	Switches the TV to standby mode when the TV receives no signal from the PC input source for 30 seconds.

Installing the accessories (Wall-Mount Bracket)

To Customers:

For product protection and safety reasons, Sony strongly recommends that installing of your TV be performed by Sony dealers or licensed contractors. Do not attempt to install it yourself.

To Sony Dealers and Contractors:

Provide full attention to safety during the installation, periodic maintenance and examination of this product.

Your TV can be installed using the Wall-Mount Bracket SU-WL50B or SU-WL100 (sold separately).

- Refer to the Instructions supplied with the Wall-Mount Bracket to properly carry out the installation.
- Refer to "Detaching the stand from the TV" (page 6).

✎ • Place the TV on the stand, when securing the Mounting Hook.

SU-WL100: (KDL-26/22BX320)

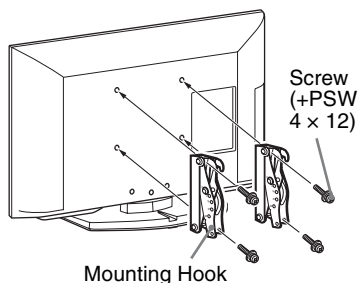

SU-WL50B: (KDL-40BX420/KDL-32BX320)

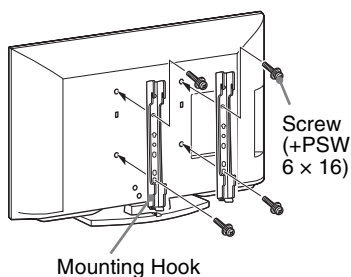

Note when installing

When using the SU-WL50B or SU-WL100 Wall-Mount Bracket, the space between the wall and the TV will be 6 cm. Use this space to route cables to the TV.

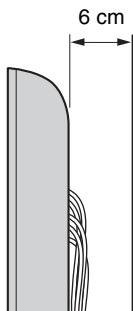

Sufficient expertise is required for installing these products, especially to determine the strength of the wall for withstanding the TV's weight. Be sure to entrust the attachment of these products to the wall to Sony dealers or licensed contractors and pay adequate attention to safety during the installation. Sony is not liable for any damage or injury caused by mishandling or improper installation.

TV installation dimensions table

SU-WL100:

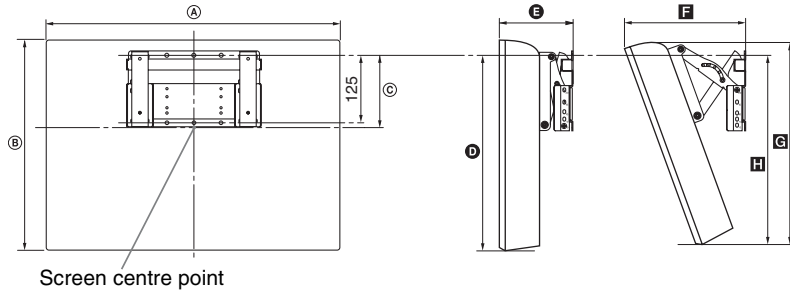

Unit: mm

Model name	Display dimensions		Screen centre dimension C	Length for each mounting angle				
	A	B		Angle (0°)		Angle (20°)		
				D	E	F	G	H
KDL-26BX320	668	424	117	336	147	244	403	338
KDL-22BX320	551	363	107	302	122	212	338	295

SU-WL50B:

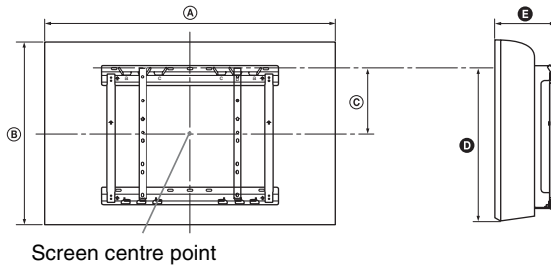

Unit: mm

Model name	Display dimensions		Screen centre dimension C	Length for mounting	
	A	B		D	E
KDL-40BX420	988	600	175	478	147
KDL-32BX320	800	496	200	453	147

Figures in the above table may differ slightly depending on the installation.

WARNING

The wall that the TV will be installed on should be capable of supporting a weight of at least four times that of the TV. Refer to "Specifications" for its weight.

Screw and hook locations diagram/table

Screw location - When installing the Mounting Hook on the TV.

SU-WL50B

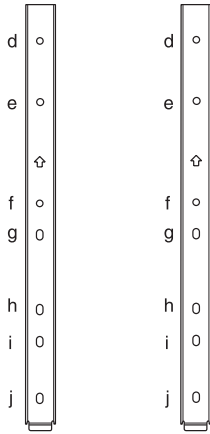

Hook location - When installing the TV onto the Base Bracket.

SU-WL100

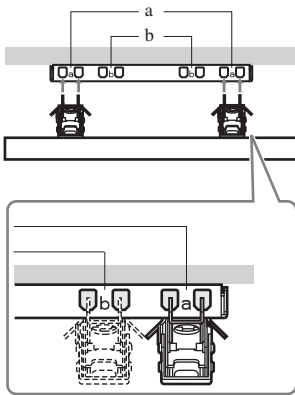

SU-WL50B

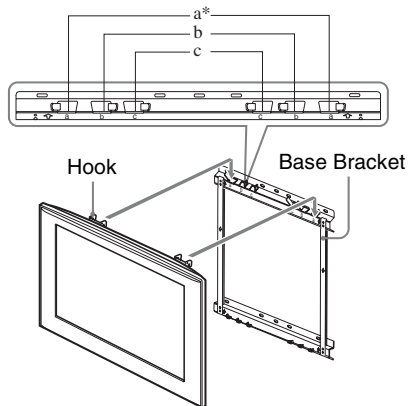

* Hook location "a" cannot be used for the models in the table below.

Model name	Screw location	Hook location
	SU-WL50B	SU-WL50B
KDL-40BX420	d, i	b
KDL-32BX320	e, h	c
		SU-WL100
KDL-26BX320		a
KDL-22BX320		b

Troubleshooting

Check whether the  (standby) indicator is flashing in red.

When it is flashing

The self-diagnosis function is activated.

- 1 Count how many times the  (standby) indicator flashes between each three second break.

For example, the indicator flashes three times, then there is a three second break, followed by another three flashes, etc.



- 2 Press  on the TV to turn it off, disconnect the AC power cord, and inform your dealer or Sony service centre of how the indicator flashes (number of flashes).

When it is not flashing

- 1 Check the items listed below.
- 2 If the problem still persists, have your TV serviced by qualified service personnel.

Picture

No picture (screen is dark) and no sound

- Check the antenna/cable connection.
- Connect the TV to the AC power outlet, and press  on the TV.
- If the  (standby) indicator lights up in red, press .

No picture or no menu information from equipment connected to the video input jack appears on the screen

- Press  to display the connected equipment list, then select the desired input.
- Check the connection between the optional equipment and the TV.

Double images or ghosting

- Check the antenna/cable connection, location or direction.

Only snow and noise appear on the screen

- Check if the antenna is broken or bent.
- Check if the antenna has reached the end of its serviceable life (three to five years in normal use, one to two years at the seaside).

Distorted picture (dotted lines or stripes)

- Keep the TV away from electrical noise sources such as cars, motorcycles, hair-dryers or optional equipment.
- When installing optional equipment, leave some space between the optional equipment and the TV.
- Check the antenna/cable connection.
- Keep the antenna cable away from other connecting cables.

Picture or sound noise when viewing a TV channel

- Adjust “AFT” (Automatic Fine Tuning) to obtain better picture reception (page 26).

Some tiny black points and/or bright points appear on the screen

- The picture of a display unit is composed of pixels. Tiny black points and/or bright points (pixels) on the screen do not indicate a malfunction.

Picture contours are distorted

- Change the current setting of “Cinema Drive” to other settings (page 21).

No colour on programmes

- Select “Reset” (page 21).

No colour or irregular colour when viewing a signal from the Y, P_B/C_B, P_R/C_R jacks of

- Check the connection of the Y, P_B/C_B, P_R/C_R jacks of  and check if each jacks are firmly seated in their respective jacks.

No picture from the connected equipment appears on the screen



- Turn the connected equipment on.
- Check the cable connection.
- Press  to display the connected equipment list, then select the desired input.
- Correctly insert the memory card or other storage device in the digital still camera.
- Use a digital still camera memory card or other storage device that has been formatted according to the instruction manual supplied with the digital still camera.
- Operations are not guaranteed for all USB devices. Also, operations differ depending on the features of the USB device and the video being played.

Cannot select the connected equipment on the menu or cannot switch the input

- Check the cable connection.

Sound

No sound, but good picture

- Press  +/- or  (Mute).
- Check if the “Speakers” is set to “TV Speakers” (page 23).

No sound or noisy sound

- Check if the TV system setting is appropriate (page 26).

Channels

The desired channel cannot be selected

- Switch between digital and analogue mode and select the desired digital/analogue channel.

Some channels are blank

- The channel is for scrambled/subscription service only. Subscribe to a pay TV service.
- Channel is used only for data (no picture or sound).
- Contact the broadcaster for transmission details.

Digital channels are not displayed

- Contact a local installer to find out if digital transmissions are provided in your area.
- Upgrade to a higher gain aerial.

General

The TV turns off automatically (the TV enters standby mode)

- Check if the “Sleep Timer” is activated (page 29).
- Check if the “Idle TV Standby” is activated (page 30).

Some input sources cannot be selected

- Select “Video Labels” and cancel “Skip” of the input source (page 29).

The remote does not function

- Replace the batteries.

HDMI equipment does not appear on “HDMI Device List”

- Check that your equipment is compatible with Control for HDMI.













Cannot select “Off” in “Control for HDMI”

- If you have connected any audio system that is compatible with Control for HDMI, you cannot select “Off” in this menu. To change the audio output to the TV speaker, select “TV Speakers” in the “Speakers” menu (page 23).

Lost password

- Select the “PIN Code” settings on the “Parental Lock” settings, then enter the following master password: 9999. This password clears your previous password and allows you to enter a new password (page 28).

Specifications

Model name	KDL-40BX420	KDL-32BX320	KDL-26BX320	KDL-22BX320	
System					
Panel system	LCD (Liquid Crystal Display) Panel				
TV system	Analogue: B/G, I, D/K Digital: DVB-T				
Colour/video system	Analogue: PAL, PAL60 (only video input), SECAM, NTSC3.58, NTSC4.43 (only video input) Digital: MPEG-2 MP@ML/HL (Australian model), MPEG-2 MP@ML/HL, H.264/MPEG-4 AVC MP/HP@L4 (New Zealand and Singaporean model)				
Channel coverage	Analogue: B/G: VHF: E2-E12/UHF: E21-E69/CATV: S01-S03, S1-S41 VHF: 0-12, 5A, 9A/UHF: 28-69/CATV: S01-S03, S1-S44 (Australia and Singapore only) VHF: 1-11/UHF: 21-69/CATV: S1-S41 (New Zealand and Singapore only) I: UHF: B21-B69/CATV: S01-S03, S1-S41 (Australia and New Zealand only) D/K: VHF: C1-C12, R1-R12/UHF: C13-C57, R21-R60/CATV: S01-S03, S1-S41, Z1-Z39 (Australia and New Zealand only) Digital: VHF/UHF (Australia and Singapore only), UHF (New Zealand only)				
Sound output	8 W + 8 W		5 W + 5 W		
Input/Output jacks					
Antenna	75 ohm external terminal for VHF/UHF				
 COMPONENT IN/  1	 COMPONENT IN Supported formats: 1080p, 1080i, 720p, 576p, 576i, 480p, 480i Y: 1 Vp-p, 75 ohms, 0.3V negative sync/Pb/Cb: 0.7 Vp-p, 75 ohms/Pr/Cr: 0.7 Vp-p, 75 ohms  1 Video input (phono jack)				
 COMPONENT IN	Audio input (phono jacks)				
 2	Video input (phono jacks)				
 2	Audio input (phono jacks)				
HDMI IN 1, 2	Video: 1080/24p, 1080p, 1080i, 720p, 576p, 576i, 480p, 480i Audio: Two channel linear PCM: 32, 44.1 and 48 kHz, 16, 20 and 24 bits  Analogue audio input (minijack) (HDMI IN 2 only) PC Input (see page 25)				
 DIGITAL AUDIO OUT (OPTICAL)	Digital optical jack (Two channel linear PCM, Dolby Digital)				
	Audio output (phono jacks)				
PC IN 	PC Input (D-sub 15-pin) (see page 25) G: 0.7 Vp-p, 75 ohms, non Sync on Green/B: 0.7 Vp-p, 75 ohms/ R: 0.7 Vp-p, 75 ohms/HD: 1-5 Vp-p/VD: 1-5 Vp-p				
PC IN 	PC audio input (minijack)				
	USB port				
	Headphones jack				
Power and others					
Power requirements	110-240 V AC, 50/60 Hz				
Screen size (measured diagonally)	inches	40	32	26	22
	cm (Approx.)	101.6	80.0	66.1	54.8
Display resolution	1,920 pixels (horizontal) × 1,080 lines (vertical)		1,366 pixels (horizontal) × 768 lines (vertical)		
Power consumption	Indicated on the rear of the TV.				
Dimensions (Approx.) (w × h × d)	with stand (mm)	988 × 632 × 250	800 × 528 × 220	668 × 455 × 220	551 × 393 × 215
	without stand (mm)	988 × 600 × 94	800 × 496 × 91	668 × 424 × 91	551 × 363 × 61
Mass (Approx.)	with stand (kg)	15.7	10.7	8.8	6.2
	without stand (kg)	13.6	9.1	7.3	5.6
Optional accessories	Wall-Mount Bracket	SU-WL50B		SU-WL100	

Design and specifications are subject to change without notice.

Instructions on "Installing the Wall-Mount Bracket" are not supplied in the form of a separate leaflet with this TV. These installation instructions are included within this TV's instructions manual.

<http://www.sony.net/>

 Customer support http://www.sony-asia.com/support

