

**Multi-CD control High power cassette player
with RDS tuner**

www.DataSheet4U.com

Manual

**KEH-P5900R
KEH-P4930R
KEH-P4900R**

Pioneer

www.DataSheet4U.com

Installation	4	Tuner operation	19
Installation with the rubber bush	4	• Local Seek Tuning	
Removing the Unit	5	• Best Stations Memory (BSM)	
Connecting the Units	6	Using RDS Functions	20
Connection in a car featuring an		What is RDS	20
ISO Connector	8	Program Service Name Display	20
Changing the switch	9	AF Function	21
Connection Diagram	10	• Activating/Deactivating the AF Function	
Key Finder	12	PI Seek Function	22
• Head Unit		• PI Seek	
• Steering Remote Controller (CD-SR77)		• Auto PI Seek (for preset station)	
Before Using This Product	13	Regional Function	22
About This Product	13	• Activating/Deactivating the REG Function	
About This Manual	13	TA Function	23
About Optional Steering Remote Controller		• Activating/Deactivating the TA Function	
(for KEH-P5900R)	13	• Canceling Traffic Announcements	
Precaution	14	• Adjusting the TA Volume	
In Case of Trouble	14	• TP Alarm Function	
Basic Operation	15	PTY Function	25
To Listen to Music	15	• PTY Search Setting Function	
Basic Operation of Tuner	16	• PTY Search Function	
• Manual and Seek Tuning		• PTY Alarm	
• Preset Tuning		• Canceling Emergency Announcements	
• Band		Using the Cassette Player	28
Basic Operation of Cassette Player	17	• Repeat Play	
• Fast Forward/Rewind and Music Search		• Blank Skip	
• Cassette Loading Slot		• Radio Intercept	
• Direction Change			
• Eject			
Basic Operation of Multi-CD Player	18		
• Track Search and Fast Forward/Reverse			
• Disc Search			
• Disc Number Search			
(for 6-Disc, 12-Disc types)			

Using Multi-CD Players29

- Repeat Play
- Random Play
- Scan Play
- Pause www.DataSheet4U.com
- Disc Title 31
 - Disc Title Input
 - Displaying Disc Title
- Playing Discs on a 50-Disc Type Multi-CD Player 33

Audio Adjustment34

- Selecting the Equalizer Curve 34
- Entering the Audio Menu 34
- Audio Menu Functions 35
 - Balance Adjustment (FAD)
 - Equalizer Curve Adjustment (EQ-LOW/MID/HIGH)
 - Loudness Adjustment (LOUD)
 - Front Image Enhancer Function (FIE)
 - Source Level Adjustment (SLA)

Detaching and Replacing the Front Panel40

- Theft protection 40
 - Detaching the Front Panel
 - Replacing the Front Panel

Initial Setting Menu 41

- Entering the Initial Setting Menu 41
- Initial Setting Menu Functions 42
 - Changing the FM Tuning Step (FM)
 - Switching the Auto PI Seek (A-PI)
 - Switching the AUX Mode (AUX)
 - Selecting the Illumination Color (ILM)

Other Functions44

- Using the AUX Source 44
 - Selecting the AUX Source
 - AUX Title Input
- Cellular Telephone Muting 44

Cassette Player and Care 45

- Precaution 45
 - About the Cassette Player
 - About Cassette Tapes
- Cleaning the Head 45

Specifications 47

Installation

Note:

- Before finally installing the unit, connect the wiring temporarily, making sure it is all connected up properly, and the unit and the system work properly.
- Use only the parts included with the unit to ensure proper installation. The use of unauthorized parts can cause malfunctions.
- Consult with your nearest dealer if installation requires the drilling of holes or other modifications of the vehicle.
- Install the unit where it does not get in the driver's way and cannot injure the passenger if there is a sudden stop, like an emergency stop.
- If installation angle exceeds 30° from horizontal, the unit might not give its optimum performance.

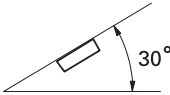

Installation with the rubber bush

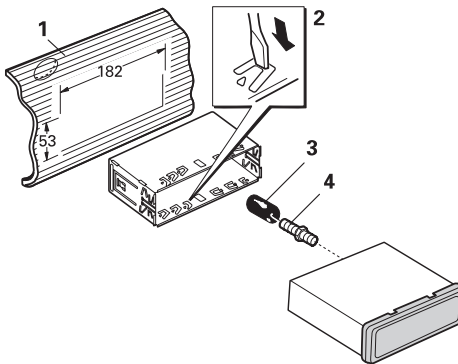

1. Dashboard
2. Holder

After inserting the holder into the dashboard, then select the appropriate tabs according to the thickness of the dashboard material and bend them. (Install as firmly as possible using the top and the bottom tabs. To secure, bend the tabs 90 degrees.)

3. Rubber bush
4. Screw

Removing the Unit

www.DataSheet4U.com

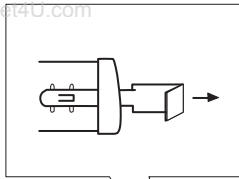

5. Insert the supplied extraction keys into the unit, as shown in the figure, until they click into place. Keeping the keys pressed against the sides of the unit, pull the unit out.

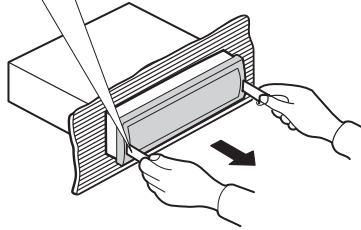

Note:

- This unit is for vehicles with a 12-volt battery and negative grounding. Before installing it in a recreational vehicle, truck, or bus, check the battery voltage.
- To avoid shorts in the electrical system, be sure to disconnect the ⊖ battery cable before beginning installation.
- Refer to the owner's manual for details on connecting the power amp and other units, then make connections correctly.
- Secure the wiring with cable clamps or adhesive tape. To protect the wiring, wrap adhesive tape around them where they lie against metal parts.
- Route and secure all wiring so it cannot touch any moving parts, such as the gear shift, handbrake and seat rails. Do not route wiring in places that get hot, such as near the heater outlet. If the insulation of the wiring melts or gets torn, there is a danger of the wiring short-circuiting to the vehicle body.
- Don't pass the yellow lead through a hole into the engine compartment to connect to the battery. This will damage the lead insulation and cause a very dangerous short.
- Do not shorten any leads. If you do, the protection circuit may fail to work when it should.
- Never feed power to other equipment by cutting the insulation of the power supply lead of the unit and tapping into the lead. The current capacity of the lead will be exceeded, causing overheating.
- When replacing fuse, be sure to use only fuse of the rating prescribed on this unit.
- Since a unique BPTL circuit is employed, never wire so the speaker leads are directly grounded or the left and right ⊖ speaker leads are common.
- Speakers connected to this unit must be high-power types with minimum rating of 40 W and impedance of 4 to 8 ohms. Connecting speakers with output and/or impedance values other than those noted here may result in the speakers catching fire, emitting smoke or becoming damaged.
- When this product's source is switched ON, a control signal is output through the blue/white lead. Connect to an external power amp's system remote control or the car's Auto-antenna relay control terminal. (Max. 300 mA 12 V DC.) If the car features a glass antenna, connect to the antenna booster power supply terminal.
- When an external power amp is being used with this system, be sure not to connect the blue/white lead to the amp's power terminal. Likewise, do not connect the blue/white lead to the power terminal of the auto-antenna. Such connection could cause excessive current drain and malfunction.
- To avoid short-circuiting, cover the disconnected lead with insulating tape. Especially, insulate the unused speaker leads without fail. There is a possibility of short-circuiting if the leads are not insulated.

- To prevent incorrect connection, the input side of the IP-BUS connector is blue, and the output side is black. Connect the connectors of the same colors correctly.
- If this unit is installed in a vehicle that does not have an ACC (accessory) position on the ignition switch, the red lead of the unit should be connected to a terminal coupled with ignition switch ON/OFF operations. If this is not done, the vehicle battery may be drained when you are away from the vehicle for several hours.



ACC position

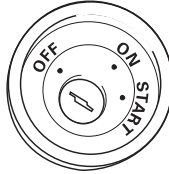

No ACC position

- The black lead is ground. Please ground this lead separately from the ground of high-current products such as power amps. If you ground the products together and the ground becomes detached, there is a risk of damage to the products or fire.

- Cords for this product and those for other products may be different colors even if they have the same function. When connecting this product to another product, refer to the supplied Installation manuals of both products and connect cords that have the same function.

Connection in a car featuring an ISO Connector

You can connect the car stereo power cord as it is.
(Do not use the power cord supplied with this unit.)

Refer to "Connection in a car not featuring an ISO Connector."

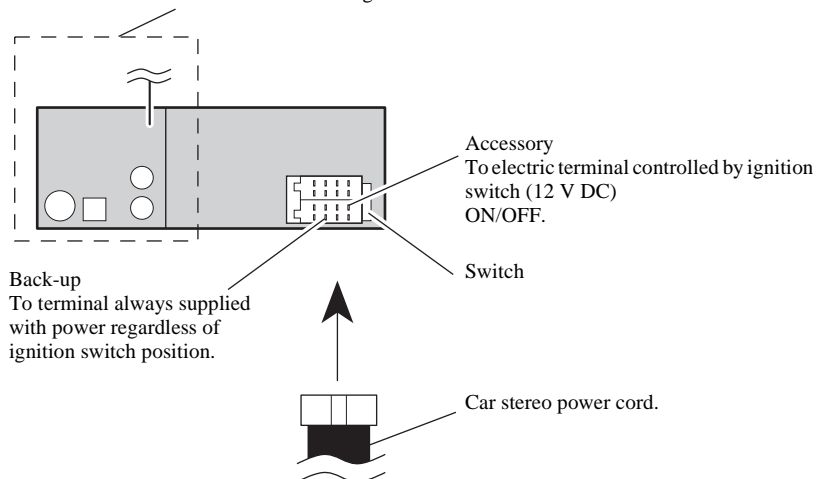

Attention:

The connector wiring may vary depending on the car manufacturer, even when ISO connectors are used. We recommend to check the car's wiring provision before connecting the car stereo. Please pay particular attention to pin 5, where a misconnection might cause damage to the car or radio.

Take special care when installing into 98 or later VW/Audi/Skoda/Seat models as there may be a 12 V connection on Pin 5, which could damage the car stereo or into Ford from 97 or later, with an ISO connector, on which damage to the car's microcomputers is possible if misconnected. Use of ISO connector adapters available on the market may facilitate installation.

Changing the switch

With some cars, it may be necessary to change the switch on the rear of this unit. Refer to the illustration above to confirm the power cord. With cars in which Back-up and ACC are reversed, insert the switch in the lower side.

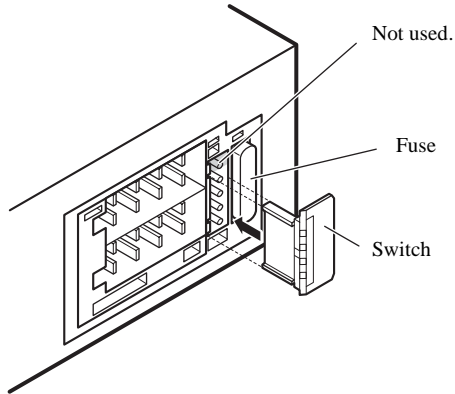

Connection Diagram

This product conforms to new cord colors.

www.DataSheet4U.com

Yellow/black

If you use a cellular telephone, connect it via the Audio Mute lead on the cellular telephone. If not, keep the Audio Mute lead free of any connections.

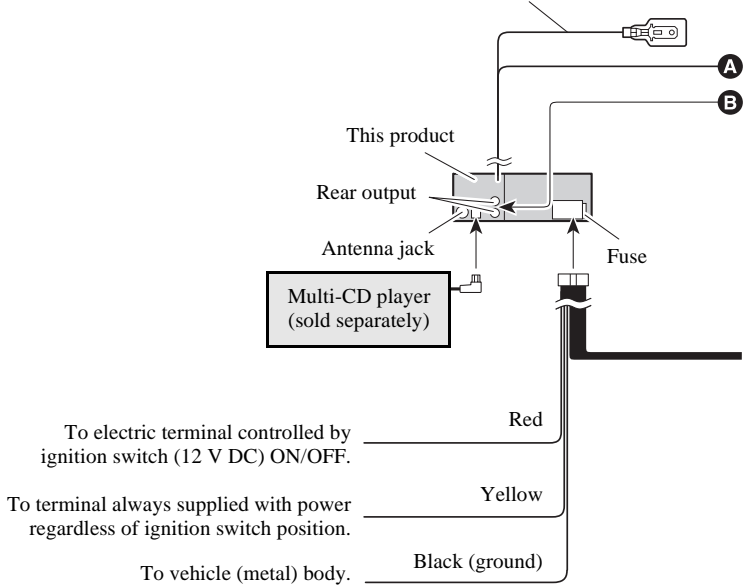

www.DataSheet4U.com

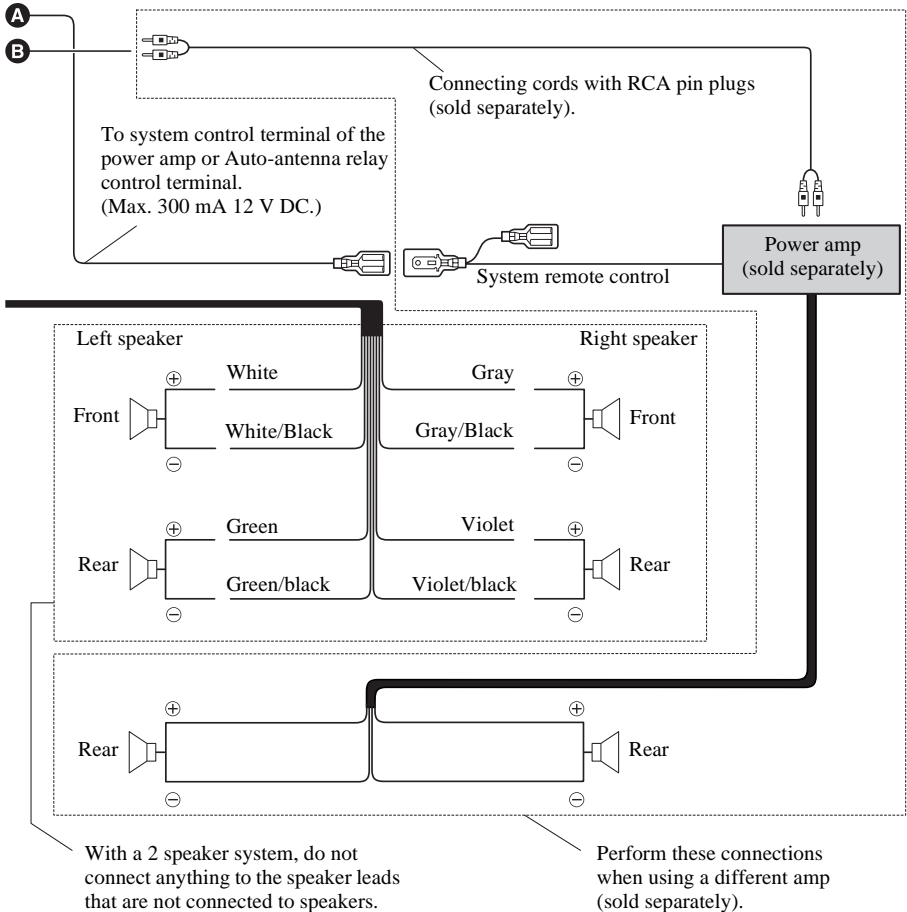

■ Head Unit

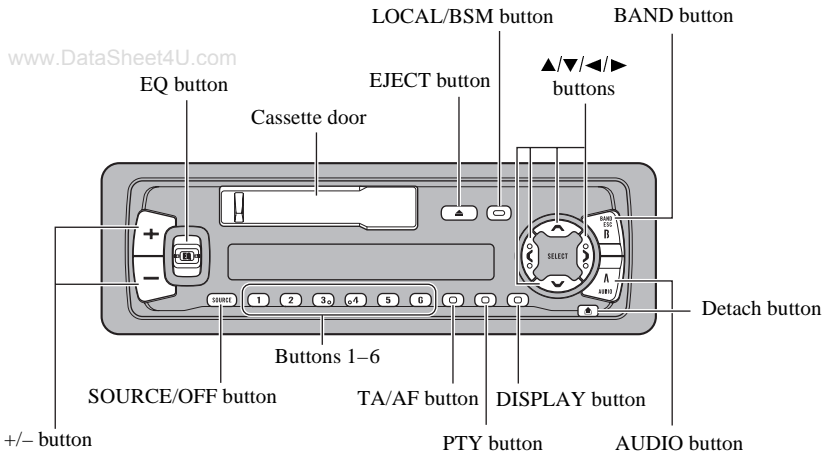

■ Steering Remote Controller (CD-SR77)

The steering remote controller (CD-SR77) is an option only for KEH-P5900R.

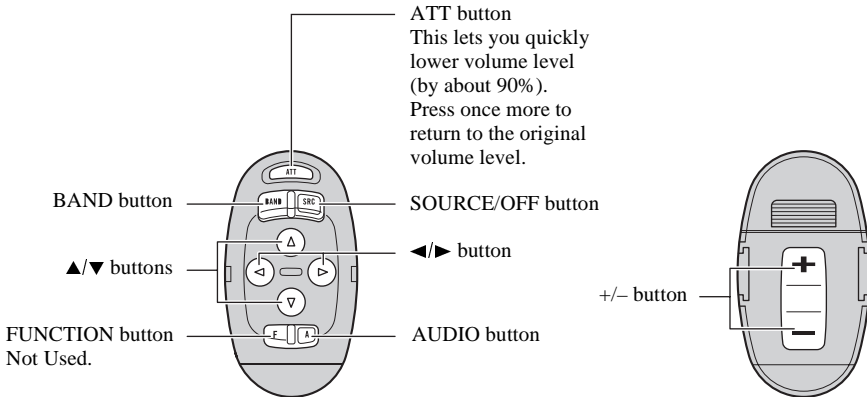

About This Product

- This product complies with the EMC Directives (89/336/EEC, 92/31/EEC) and CE Marking Directive (93/68/EEC).

The tuner frequencies on this product are allocated for use in Western Europe, Asia, the Middle East, Africa and Oceania. Use in other areas may result in improper reception.

The RDS function operates only in areas with FM stations broadcasting RDS signals.

About This Manual

This product features a number of sophisticated functions ensuring superior reception and operation. All are designed for the easiest possible use, but many are not self-explanatory. This operation manual is intended to help you benefit fully from their potential and to maximize your listening enjoyment.

We recommend that you familiarize yourself with the functions and their operation by reading through the manual before you begin using this product. It is especially important that you read and observe the “Precaution” on the next page and in other sections.

This manual explains head unit operation. You can perform the same operations with the steering remote controller (CD-SR77) only when operating KEH-P5900R. The steering remote controller offers the convenience of ATT, a function not provided on the head unit.

About Optional Steering Remote Controller (for KEH-P5900R)

Optional steering remote controller (CD-SR77) for KEH-P5900R has a switch inside the cover on the back. Use the steering remote controller in the MAIN UNIT position without switching. (Initially, it is already set to the MAIN UNIT position.) This product will not work properly in the other positions.

Before Using This Product

Precaution

- The Pioneer CarStereo-Pass is for use only in Germany.
- Keep this manual handy as a reference for operating procedures and precautions.
- Always keep the volume low enough for outside sounds to be audible.
- Protect this product from moisture.
- If the battery is disconnected, the preset memory will be erased and must be reprogrammed.

In Case of Trouble

Should this product fail to operate properly, contact your dealer or nearest authorized Pioneer Service Station.

To Listen to Music

The following explains the initial operations required before you can listen to music.

Note: www.DataSheet4U.com

- Loading a cassette in this product. (Refer to page 17.)

1. Select the desired source (e.g. Tuner).



Each press changes the Source ...

Each press of the SOURCE/OFF button selects the desired source in the following order:
Tuner → Tape → Multi-CD player → External Unit → AUX

Note:

- External Unit refers to a Pioneer product (such as one available in the future) that, although incompatible as a source, enables control of basic functions by this product. Only one External Unit can be controlled by this product.
- In the following cases, the sound source will not change:
 - * When a product corresponding to each source is not connected to this product.
 - * When no tape is set in this product.
 - * When no magazine is set in the Multi-CD player.
 - * When the AUX (external input) is set to OFF. (Refer to page 43.)
- When this product's blue/white lead is connected to the car's Auto-antenna relay control terminal, the car's Auto-antenna extends when this product's source is switched ON. To retract the antenna, switch the source OFF.

2. Raise or lower the volume.

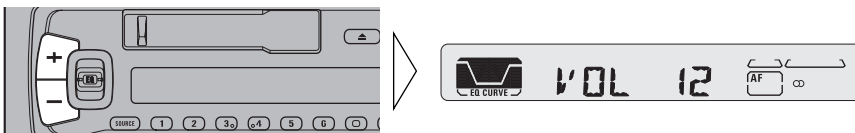

3. Turn the source OFF.

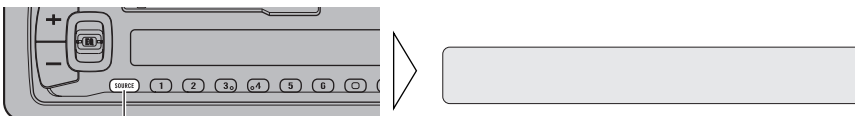

Hold for 1 second

Basic Operation of Tuner

This product's AF function can be switched ON and OFF. AF should be switched OFF for normal tuning operations. (Refer to page 21.)

Manual and Seek Tuning

- You can select the tuning method by changing the length of time you press the ◀▶ button.

Manual Tuning (step by step)	0.5 seconds or less
------------------------------	---------------------

Seek Tuning	0.5 seconds or more
-------------	---------------------

Note:

- If you continue pressing the button for longer than 0.5 seconds, you can skip broadcast stations. Seek Tuning starts as soon as you stop pressing the button.
- Stereo indicator "◯" stereo indicator lights when a stereo station is selected.

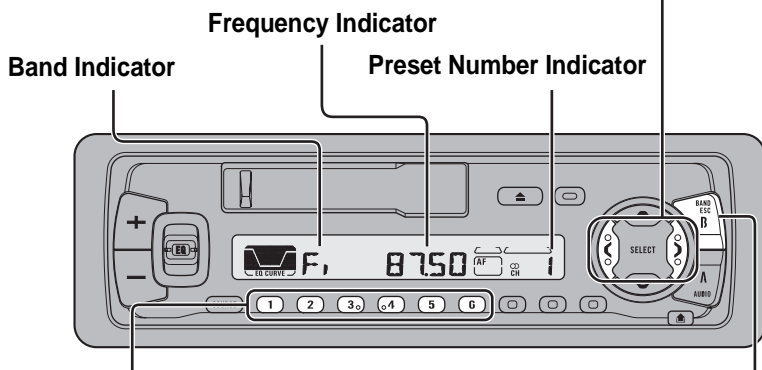

Preset Tuning

- You can memorize broadcast stations in buttons 1 through 6 for easy, one-touch station recall.

Preset station recall	2 seconds or less
-----------------------	-------------------

Broadcast station preset memory	2 seconds or more
---------------------------------	-------------------

Note:

- Up to 18 FM stations (6 in F_I (FM1), F_{II} (FM2) and F_{III} (FM3)) and 6 MW/LW stations can be stored in memory.
- You can also use the ▲ or ▼ buttons to recall broadcast stations memorized in buttons 1 through 6.

Band

F_I (FM1) → F_{II} (FM2)
→ F_{III} (FM3)

Basic Operation of Cassette Player

www.DataSheet4U.com

Fast Forward/Rewind and Music Search

- Each press of the ► button selects **Fast Forward** or **Forward-Music Search**.
FF (Fast Forward) → F-MS (Forward-Music Search) → Normal Playback
- Each press of the ◀ button selects **Rewind** or **Rewind-Music Search**.
REW (Rewind) → R-MS (Rewind-Music Search) → Normal Playback

Note:

- Fast Forward/Rewind and Music Search can be canceled by pressing the BAND button.

Cassette Loading Slot

Direction Indicator

Direction Change

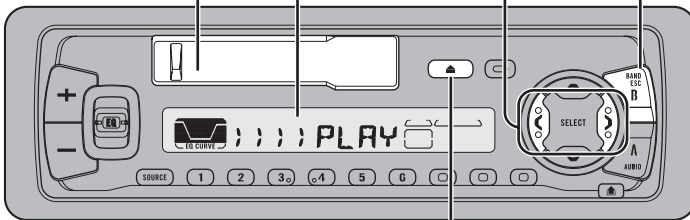

Eject

Note:

- The Tape function can be turned ON/OFF with the cassette tape remaining in this product.
(Refer to page 15.)

Basic Operation of Multi-CD Player

This product can control a Multi-CD player (sold separately).

www.DataSheet4U.com

Track Search and Fast Forward/Reverse

- You can select between Track Search or Fast Forward/Reverse by pressing the ◀▶ button for a different length of time.

Track Search	0.5 seconds or less
Fast Forward/Reverse	Continue pressing

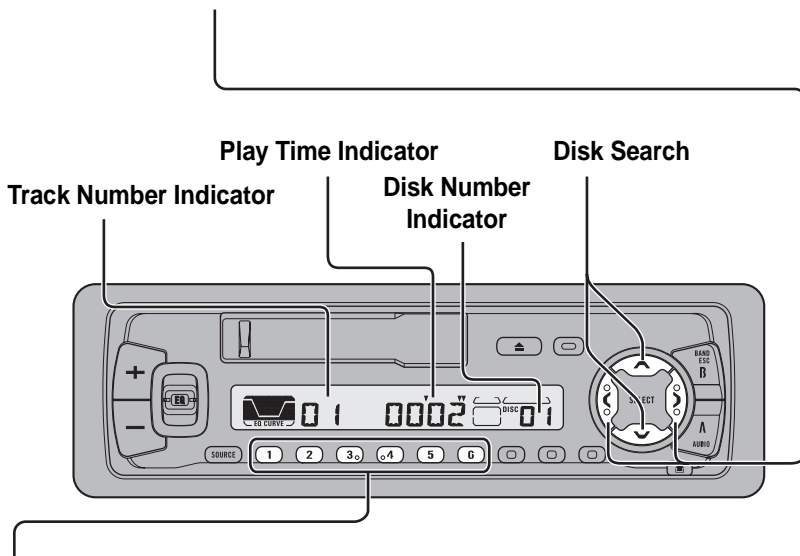

Disc Number Search (for 6-Disc, 12-Disc types)

- You can select discs directly with the 1 to 6 buttons. Just press the number corresponding to the disc you want to listen to.

Note:

- When a 12-Disc Multi-CD Player is connected and you want to select disc 7 to 12, press the 1 to 6 buttons for 2 seconds or longer.

Note:

- The Multi-CD player may perform a preparatory operation, such as verifying the presence of a disc or reading disc information, when the power is turned ON or a new disc is selected for playback. "READY" is displayed.
- If the Multi-CD player cannot operate properly, an error message such as "ERROR-14" is displayed. Refer to the Multi-CD player owner's manual.
- If there are no discs in the Multi-CD player magazine, "NO DISC" is displayed.

Tuner operation

■ Local Seek Tuning

This function selects only stations with especially strong signals.

- Switch the Local ON/OFF with the LOCAL/BSM button.



■ Best Stations Memory (BSM)

The BSM function stores stations in memory automatically.

- Press the LOCAL/BSM button for 2 seconds to switch BSM ON.



The stations with the strongest signals will be stored under buttons 1–6 and in order of their signal strength.

- To cancel the process, press the LOCAL/BSM button before memorization is complete.

What is RDS?

RDS (Radio Data System) is a system for transmitting data along with FM programs. This data, which is inaudible, provides a variety of features such as: program service name, program type display, traffic announcement standby, automatic tuning and program type tuning, intended to aid radio listeners in tuning to a desired station.

Note:

- RDS service may not be provided by all stations.
- RDS functions, like AF (Alternative frequencies search) and TA (Traffic Announcement standby), are only active when your radio is tuned to RDS stations.

Program Service Name Display

With this function, the names of networks/stations providing RDS services replace the frequency on the display a few seconds after they are tuned in.

- **When you want to know PTY Information or the frequency of the current station, change the display.**

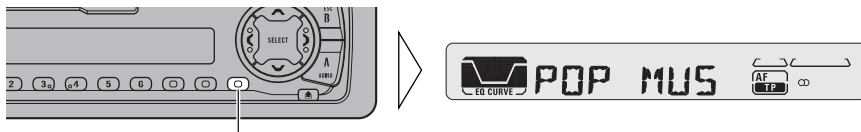

Each press changes the Display ...

Each press of the DISP button selects the display in the following order:
Program Service Name → PTY Information → Frequency

Note:

- After switching displays, if you do not perform an operation within 8 seconds, the Program Service Name is automatically displayed.

■ PTY Information

PTY (Program Type ID code) information for the currently tuned station appears on the display for 8 seconds. The information is correlated with the list in the section "PTY Function" on page 25.

Note:

- If a PTY code of zero is received from a station, "NONE" will be displayed. This indicates that the station has not defined its program contents.
- If the signal is too weak for this product to pick up the PTY code, "NO PTY" will be displayed.

■ Frequency

The frequency of the current station appears on the display.

AF Function

The AF (Alternative Frequencies search) function is used to search for other frequencies in the same network as the currently tuned station. It automatically retunes the receiver to another frequency in the network which is broadcasting a stronger signal when there are problems with reception of the currently tuned station or better reception is possible on a different frequency.

Note:

- AF tunes the receiver only to RDS stations when you use Seek tuning or BSM Auto Memory with the "AF" indicator ON.
- When you recall a preset station, the tuner may update the preset station with a new frequency from the station's AF list. (This is only available when using presets on the FM1 band.) No preset number appears on the display if the RDS data for the station received differs from that for the originally stored station.
- Sound may be temporarily interrupted by another program during an AF frequency search.
- When the tuner is tuned to a non-RDS station, the "AF" indicator flashes.
- AF can be switched ON or OFF independently for each FM band.

■ Activating/Deactivating the AF Function

AF is set to ON by default.

● Turn AF to OFF.

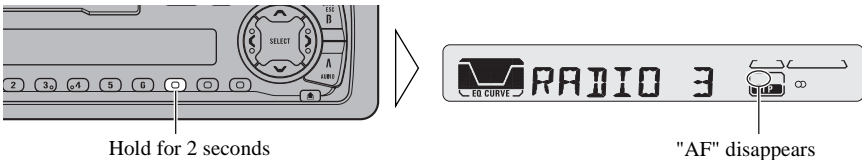

To turn AF back ON, repeat the preceding operation.

PI Seek Function

The tuner searches for another frequency broadcasting the same programming. "PI SEEK" appears on the display and the radio volume is muted during a PI Seek. The muting is discontinued after completion of the PI Seek, whether or not the PI seek has succeeded. If the PI Seek is unsuccessful, the tuner returns to the previous frequency.

■ **PI Seek**

If the tuner fails to locate a suitable alternative frequency or if the broadcasting signal is too weak for proper reception, the PI Seek will automatically start.

■ **Auto PI Seek (for preset station)**

When preset stations cannot be recalled, as when traveling long distances, this product can be set to perform PI Seek also during preset recall.

The default setting for Auto PI Seek is OFF.

Note:

- Refer to "Initial Setting" for details on how to switch Auto PI Seek ON/OFF.

Regional Function

When AF is used to retune the tuner automatically, REG (regional) limits the selection to stations broadcasting regional programs.

Note:

- Regional programming and regional networks are organized differently depending on the country (i.e., they may change according to the hour, state or broadcast area).
- The preset number may disappear on the display if the tuner tunes in a regional station which differs from the originally set station.
- REG can be switched ON or OFF independently for each FM band.

■ **Activating/Deactivating the REG Function**

The REG function is set to ON by default.

● **Turn REG to OFF.**

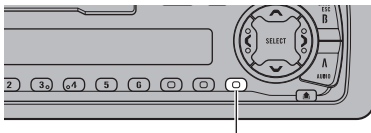

Hold for 2 seconds



To turn REG back ON, repeat the preceding operation.

TA Function

The TA (Traffic Announcement standby) function lets you receive traffic announcements automatically, no matter what source you are listening to. The TA function can be activated for either a TP station (a station that broadcasts traffic information) or an EON TP station (a station carrying information which cross-references TP stations).

■ Activating/Deactivating the TA Function

1. Tune in a TP or EON TP station.

The "TP" indicator lights when the tuner is tuned to a TP station or an EON TP station.

2. Activate the TA function.

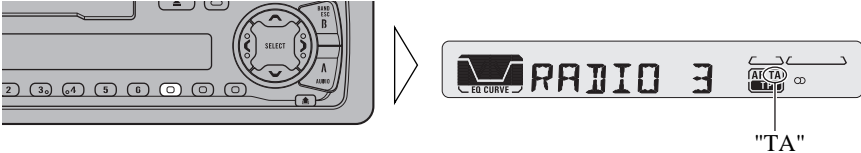

The "TA" indicator lights, indicating that the tuner is waiting for traffic announcements.

Repeat the preceding operation when no traffic announcement is being received to deactivate the TA function.

Note:

- The system switches back to the original source following traffic announcement reception.
- The TA function can be activated from sources other than tuner if the tuner was last set to the FM band but not if it was last set to the MW/LW band.
- If the tuner was last set to FM, turning on the TA function lets you operate other tuning functions while listening to the sources other than tuner.
- Only TP or EON TP stations are tuned in during the Seek Tuning mode when the "TA" indicator is ON.
- Only TP or EON TP stations are stored by BSM when the "TA" indicator is ON.

■ Canceling Traffic Announcements

- Press the TA/AF button while a traffic announcement is being received to cancel the announcement and return to the original source.

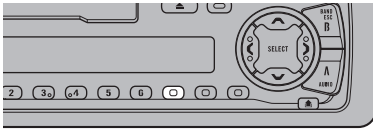

The announcement is canceled but the tuner remains in the TA mode until the TA/AF button is pressed again.

■ Adjusting the TA Volume

When a traffic announcement begins, the volume adjusts automatically to a preset level to enable you to hear the announcement clearly.

- Set the volume by adjusting it during reception of a traffic announcement.

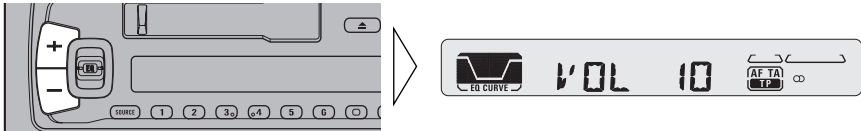

The newly set volume is stored in memory and recalled for subsequent traffic announcements.

■ TP Alarm Function

About 30 seconds after the "TP" indicator is extinguished due to a weak signal, a 5 second beep sounds to remind you to select another TP or EON TP station.

- If you are listening to the tuner, tune in another TP station or EON TP station.

In sources other than tuner, the tuner automatically seeks out the TP station with the strongest signal in the current area 10 (or 30)* seconds after "TP" disappears from the display.

* Time taken before Seek begins.

TA function ON	10 seconds
TA, AF functions ON	30 seconds

PTY Function

The PTY function enables you to select stations by the type of programming they broadcast (PTY Search). It also provides automatic tuning to emergency broadcasts (PTY Alarm).

Note:

- PTY code program types are as follows:
 1. NEWS: News.
 2. AFFAIRS: Current affairs.
 3. INFO: General information and advice.
 4. SPORT: Sports programs.
 5. EDUCATE: Educational programs.
 6. DRAMA: All radio plays and serials.
 7. CULTURE: Programs concerned with any aspect of national or regional culture.
 8. SCIENCE: Programs about nature, science and technology.
 9. VARIED: Light entertainment programs.
 10. POP MUS: Popular music.
 11. ROCK MUS: Contemporary modern music.
 12. EASY MUS: Easy listening music.
 13. L. CLASS: Light classical music.
 14. CLASSIC: Serious classical music.
 15. OTH MUS: Other types of music, which can't be categorized.
 16. WEATHER: Weather reports/Meteorological information.
 17. FINANCE: Stock market reports, commerce, trading etc.
 18. CHILDREN: Children's programs.
 19. SOCIAL: Social affairs programs.
 20. RELIGION: Religion affairs programs or services.
 21. PHONE IN: Phone in based programs.
 22. TOURING: Travel programs, not for announcements about traffic problem.
 23. LEISURE: Programs about hobbies and recreational activities.
 24. JAZZ: Jazz music based programs.
 25. COUNTRY: Country music based programs.
 26. NAT MUS: National music based programs.
 27. OLDIES: Oldies music, 'Golden age' based programs.
 28. FOLK MUS: Folk music based programs.
 29. DOCUMENT: Documentary programs.

■ PTY Search Setting Function

1. Enter the PTY Search setting mode.

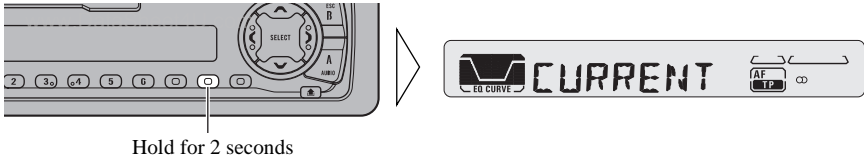

The name of a program type appears on the display for 5 seconds.

Note:

- CURRENT sets desired PTY to the program type of the current station (only for RDS stations broadcasting PTY information).

2. Select one of the PTYs.

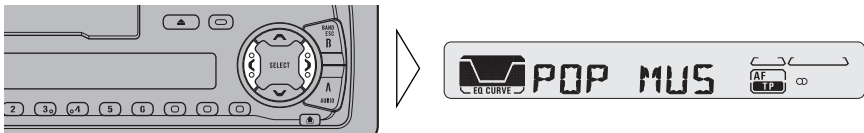

3. When the desired programming type appears on the display, return to the normal display.

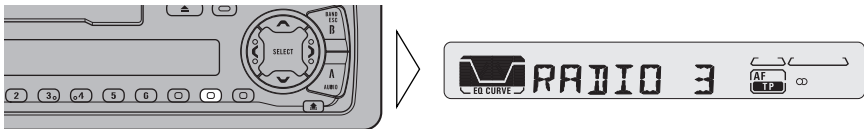

■ PTY Search Function

- **Initiate a PTY search.**

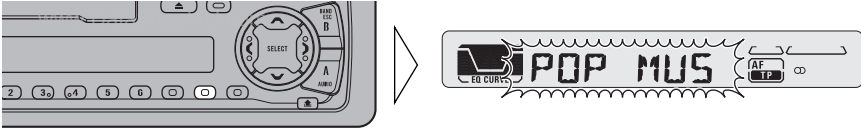

The tuner searches for a station broadcasting the desired PTY.

Note:

- The program of some stations may differ from that indicated by the transmitted PTY.
- If no station broadcasting the selected programming type is found, "NOTFOUND" is displayed for about 2 seconds, and the tuner returns to the original station.

■ PTY Alarm

PTY Alarm is a special PTY code for announcements regarding emergencies such as natural disasters. When the tuner receives the radio alarm code, "ALARM" appears on the display and the volume adjusts to the TA volume. When the station stops broadcasting the emergency announcement, the system returns to the previous source.



Note:

- The system switches back to the original source following emergency announcement reception.

■ Canceling Emergency Announcements

- **Press the TA/AF button during emergency announcement reception to cancel the announcement and return to the previous source.**

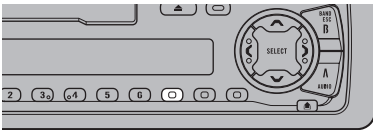

Using the Cassette Player

■ Repeat Play

The repeat mode lets you hear the same song over again.

- Switch the Repeat Play ON/OFF with the PTY button .



■ Blank Skip

This function fast-forwards to the next song automatically if there is a long period of silence (12 seconds or longer) between songs.

- Switch the Blank Skip ON/OFF with the button 5.



■ Radio Intercept

This function allows you to listen to the radio during tape fast-forwarding/rewinding.

Note:

- The radio intercept function does not work during a Music Search operation.
- Switch the Radio Intercept ON/OFF with the button 6.



Repeat Play

There are three repeat play ranges: One-track Repeat, Disc Repeat and Multi-CD player Repeat. Default repeat play range is Multi-CD player Repeat.

www.DataSheet4U.com

● Select the desired repeat play range with the PTY button.

Multi-CD player Repeat (Nothing) → One-track Repeat (“RPT” indicator lights) → Disc Repeat (“RPT” and “DISC” indicators light)

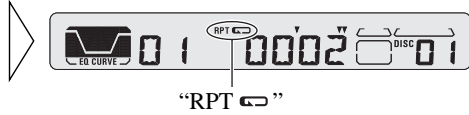

Note:

- If you select other discs during the repeat play, the repeat play range changes to Multi-CD player Repeat.
- If you perform Track Search or Fast Forward/Reverse during One-track Repeat, the repeat play range changes to Disc Repeat.

Random Play

Tracks are played at random within the selected repeat play range as explained in “Repeat Play” above.

● Press the PTY button for 2 seconds to switch the Random Play ON/OFF.

After selecting the desired repeat play range from those referred to in “Repeat Play” above, switch Multi-CD Player Random Play ON.



Indicator	Play range
“RPT” + “DISC”	Disc Repeat
Nothing	Multi-CD player Repeat

Note:

- One-track Repeat changes to the Disc Repeat when you switch the Random Play ON.

■ Scan Play

In the Disc Repeat, the beginning of each track on the selected disc is scanned for about 10 seconds. In the Multi-CD player Repeat, the beginning of the first track on each disc is scanned for about 10 seconds.

1. Press the LOCAL/BSM button for 2 seconds to switch the Scan Play ON.

After selecting the desired repeat play range from those referred to in “Repeat Play” on page 29, switch Multi-CD Player Scan Play ON.



2. When you find the desired track (or disc), cancel the Scan Play by pressing the LOCAL/BSM button for 2 seconds.



Indicator	Play range
“RPT” + “DISC”	Disc Repeat
Nothing	Multi-CD player Repeat

Note:

- Scan Play is canceled automatically after all the tracks or discs have been scanned.
- One-track Repeat changes to the Disc Repeat when you switch the Scan Play ON.

■ Pause

Pause pauses the currently playing track.

- Switch the Pause play ON/OFF with the LOCAL/BSM button.



Disc Title

■ Disc Title Input

You can input Titles up to 8 letters long for up to 100 discs. Using this function lets you easily search for and select a desired disc for play.

1. Play the disc you wish to input the disc title.
2. Select the Disc Title Input mode by pressing the DISPLAY button for 2 seconds.

Note:

- When playing a CD TEXT disc on a CD TEXT compatible Multi-CD player, you cannot switch to this mode.
- A CD TEXT disc is a CD featuring recorded text information such as Disc Title.

3. Select letters, numbers and symbols with the ▲/▼ buttons.

To insert a space, select the flashing cursor “_”.



4. Move the box left and right with the ◀/▶ buttons.

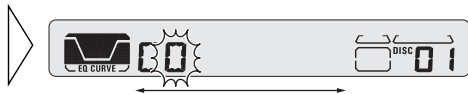

5. When you have completed title input, make the 8th letter flash, then memorize by pressing the ► button.



Note:

- Titles remain in memory, even after the disc has been removed from the magazine, and are recalled when the disc is reinserted.
- After the titles for 100 discs have been entered, data for a new disc will overwrite the data for the disc that has not been played back for the longest time.
- You can display the disc title of the disc currently playing. For details, refer to “Displaying Disc Title” on page 32.

■ Displaying Disc Title

You can display the currently playing Disc Title.

Note:

- You can also display the currently playing Disc Title when playing a CD TEXT disc on a CD TEXT compatible Multi-CD player.

● **Switch the Disc Title Display with the DISPLAY button.**

Each press of the DISPLAY button changes the display in the following order:

Playback mode (Play Time) →
Disc Title



Note:

- If you switch displays when disc titles have not been input, "NO TITLE" is displayed.
- When playing a CD TEXT disc on a CD TEXT compatible Multi-CD Player:
- You can use the Disc Title display function only.
- You cannot scroll the display. Therefore you can only display the first 8 letters of the title even if the title is more than 8 letters.

Playing Discs on a 50-Disc Type Multi-CD Player

When a magazine is loaded into a 50-Disc type Multi-CD Player, information on all the discs in the magazine is read.

If you start playing a disc on a 50-Disc type Multi-CD Player before reading of information on all discs has been completed, reading of information stops part way through.

Note:

- “LOAD” will be displayed in the following cases:
 - * If the disc in the extra tray is selected.
 - * If the disc is moved from the extra tray to the magazine.
(Refer to the 50-Disc type Multi-CD player owner’s manual.)
- You cannot use the “Ejecting a Single Disc”, “Frequency Play”, “Music Group Play” or “ABC Disc Title Search” functions with this product.

■ Disc Number Rough Search

This handy function lets you select discs loaded in a 50-Disc Multi-CD Player using the 1 to 5 buttons. The 50 discs are divided into five blocks, with each of the 1 to 5 buttons assigned to a block.

- **Select the desired block with the 1 to 5 buttons.**

Note:

- After completing a rough search, use the ▲ and ▼ buttons to select a desired disc.

Selecting the Equalizer Curve

You can switch between Equalizer curves.

- Move the EQ button up or down to select the desired Equalizer curve.

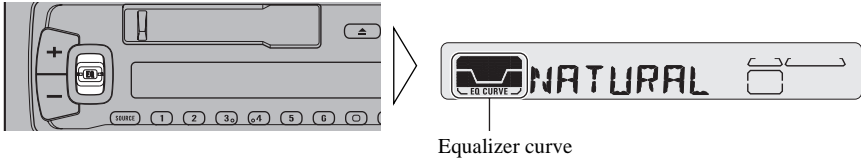

POWERFUL ↔ NATURAL ↔ VOCAL ↔ CUSTOM ↔ EQ FLAT ↔ S-BASS

Note:

- “CUSTOM” stores an equalizer curve you have made adjustments to. (Refer to “Equalizer Curve Adjustment” on page 36.)

Entering the Audio Menu

With this Menu, you can adjust the sound quality.

Note:

- After entering the Audio Menu, if you do not perform an operation within about 30 seconds, the Audio Menu is automatically canceled.

1. Select the desired mode in the Audio Menu.

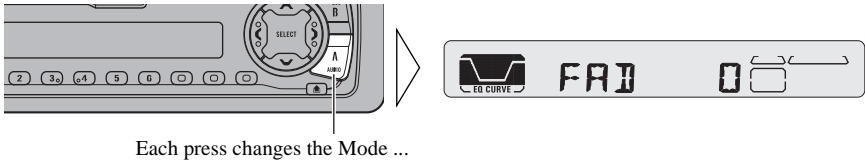

2. Operate a mode.

3. Cancel the Audio Menu.

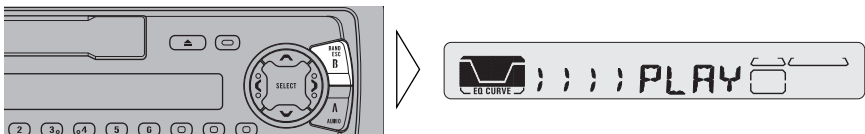

Audio Menu Functions

The Audio Menu features the following functions.

■ Balance Adjustment (FAD)

This function allows you to select a Fader/Balance setting that provides ideal listening conditions in all occupied seats.

1. Press the **AUDIO** button and select the **Fader/Balance mode (FAD)** in the **Audio Menu**.

2. Adjust front/rear speaker balance with the **▲/▼** buttons.

“FAD F15” – “FAD R15” is displayed as it moves from front to rear.



3. Adjust left/right speaker balance with the **◀/▶** buttons.

“BAL L9” – “BAL R9” is displayed as it moves from left to right.



Note:

- “FAD 0” is the proper setting when 2 speakers are in use.

■ Equalizer Curve Adjustment (EQ-L/M/H)

You can adjust the currently selected equalizer curve settings as desired. Adjusted equalizer curve settings are memorized in “CUSTOM”.

www.DataSheet4U.com

1. Press the **AUDIO** button and select the Equalizer mode (EQ-L/M/H) in the Audio Menu.

2. Select the band you want to adjust with the **◀/▶** buttons.

EQ-L ↔ EQ-M ↔ EQ-H



3. Boost or attenuate the selected band with the **▲/▼** buttons.

The display shows “+6” – “- 6”.



Note:

- If you make adjustments when a curve other than “CUSTOM” is selected, the newly adjusted curve will replace the previous adjusted curve. Then a new curve with “- (CUSTOM EQ)” appears on the display while selecting the equalizer curve. (Refer to page 34.)

■ Loudness Adjustment (LOUD)

The Loudness function compensates for deficiencies in the low and high sound ranges at low volume. You can select a desired Loudness level.

www.DataSheet4U.com

1. Press the **AUDIO** button and select the Loudness mode (**LOUD**) in the Audio Menu.

2. Switch the Loudness function ON/OFF with the ▲/▼ buttons.



3. Select the desired level with the ◀/▶ buttons.

LOW → MID → HI



■ Front Image Enhancer Function (FIE)

The F.I.E. (Front Image Enhancer) function is a simple method of enhancing front imaging by cutting mid- and high-range frequency output from the rear speakers, limiting their output to low-range frequencies. You can select the frequency you want to cut.

Precaution

- When the F.I.E. function is deactivated, the rear speakers output sound of all frequencies, not just bass sounds. Reduce the volume before disengaging F.I.E. to prevent a sudden increase in volume.

1. Press the **AUDIO** button and select the **F.I.E. mode (FIE)** in the Audio Menu.

2. Switch the **F.I.E. function ON/OFF** with the **▲/▼** buttons.



3. Select the desired frequency with the **◀/▶** buttons.

100 ↔ 160 ↔ 250 (Hz)



Note:

- After switching the F.I.E. function ON, select the Fader/Balance mode in the Audio Menu, and adjust front and rear speaker volume levels until they are balanced.
- Switch the F.I.E. function OFF when using a 2-speaker system.

■ Source Level Adjustment (SLA)

The SLA (Source Level Adjustment) function prevents radical leaps in volume level when switching between sources. Settings are based on the FM volume level, which remains unchanged. (Since the FM volume is the control, SLA is not possible in the FM modes.) The MW/LW, cassette, CD, External Unit and AUX levels can all be adjusted.

1. Compare the FM volume with the volume of the other source.
(e.g. Cassette player.)
2. Press the **AUDIO** button and select the SLA mode (SLA) in the Audio Menu.
3. Increase or decrease the level with the ▲/▼ buttons.

The display shows “+4” – “-4”.



Theft Protection

The front panel of the head unit is detachable to discourage theft.

■ Detaching the Front Panel

1. Eject the front panel.

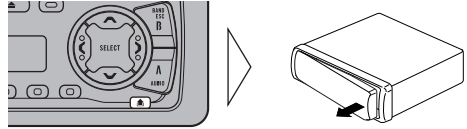

2. To remove the front panel, pull its right-hand side toward you.

Take care not to grip it tightly or drop it.

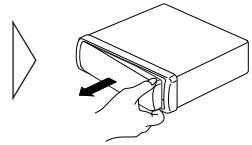

3. Use the protective case provided to store/carry the detached front panel.

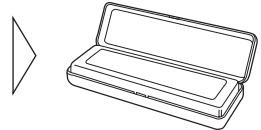

■ Replacing the Front Panel

● Replace the front panel by clipping it into place.

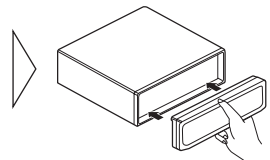

Precaution:

- Never use force or grip the display tightly when removing or replacing the front panel.
- Avoid subjecting the front panel to excessive shocks.
- Keep the front panel out of direct sunlight and high temperatures.

Entering the Initial Setting Menu

With this menu, you can perform initial settings for this product.

1. Switch the source OFF.

2. Enter the Initial Setting Menu.

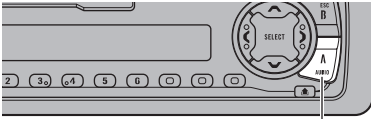

Hold for 2 seconds



3. Select a desired mode.

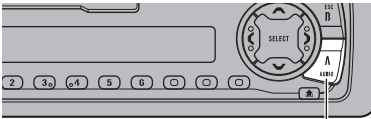

Each press changes the Mode...



4. Operate a mode.

5. Cancel the Initial Setting Menu.

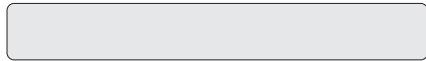
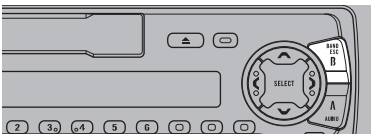

Note:

- Holding down the AUDIO button for 2 seconds also cancels the Initial Setting Menu.

Initial Setting Menu Functions

■ Changing the FM Tuning Step (FM)

Normally set at 50 kHz during Seek tuning in the FM mode, the tuning step changes to 100 kHz when the AF or TA mode is activated.

It may be preferable to set tuning step to 50 kHz in the AF mode.

1. Press the **AUDIO** button and select the **FM Tuning Step mode (FM)** in the **Initial Setting Menu**.
2. Select the desired tuning step with the **▲/▼** buttons.



Note:

- The tuning step remains set at 50 kHz during Manual tuning.
- The tuning step returns to 100 kHz if the battery is temporarily disconnected.

■ Switching the Auto PI Seek (A-PI)

During Preset Station PI Seek operation, you can switch the Auto PI Seek function ON/OFF. (Refer to "PI Seek Function" on page 22.)

1. Press the **AUDIO** button and select the **Auto PI Seek mode (A-PI)** in the **Initial Setting Menu**.
2. Switch the Auto PI Seek ON/OFF with the **▲/▼** buttons.



■ Switching the AUX Mode (AUX)

It is possible to use auxiliary (AUX) equipment with this product.

Activate the AUX mode when using external equipment with this product.

www.DataSheet4U.com

1. Press the **AUDIO** button and select the **AUX Setting mode (AUX)** in the **Initial Setting Menu**.
2. Switch the **AUX ON/OFF** with the **▲/▼** buttons.



■ Selecting the Illumination Color (ILM)

KEH-P5900R is equipped with two illumination colors, green and red.

You can select the desired illumination color.

1. Press the **FUNCTION** button and select the **Illumination Color mode (ILM)** in the **Initial Setting Menu**.
2. Select the desired illumination color with the **◀/▶** buttons.



Using the AUX Source

It is possible to use auxiliary (AUX) equipment with this product.

To listen to auxiliary equipment, switch the AUX mode in the Initial Setting Menu ON, and then select the desired source.

■ Selecting the AUX Source

- **Select AUX. (Refer to page 15.)**

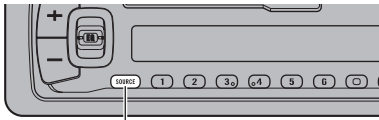

Each press changes the Source ...



■ AUX Title Input

The display title for AUX source can be changed.

1. **Select the Aux Title Input mode by pressing the DISPLAY button for 2 seconds.**

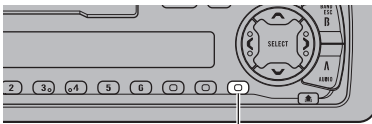

Hold for 2 seconds



2. **Input the Aux Title.**

Refer to “Disc Title Input” on page 31, and perform procedures 3 to 5 in the same way.

Cellular Telephone Muting

Sound from this system is muted automatically when a call is made or received using a cellular telephone connected to this product.

- The sound is turned off, “MUTE” is displayed and no audio adjustment is possible. Operation returns to normal when the phone connection is ended.



Precaution

■ About the Cassette Player

- A loose or warped label on a cassette tape may interfere with the eject mechanism of the unit or cause the cassette to become jammed in the unit. Avoid using such tapes or remove such labels from the cassette before attempting use.
- The music search and repeat functions may not work properly with the following kinds of recorded tapes because the gap between songs cannot be found correctly.
 - * A tape with a gap of 4 seconds or less between songs.
 - * A tape containing dialog, etc., with pauses lasting for 4 seconds or longer.
 - * A tape with an extremely quiet passage in the music lasting for 4 seconds or longer.

■ About Cassette Tapes

- Do not use tapes longer than C-90 type (90 min.) cassettes. Longer tapes can interfere with tape transport.
- Storing cassettes in areas directly exposed to sunlight or high temperatures can distort them and subsequently interfere with tape transport.



- Store unused tapes in a tape case where there is no danger of them becoming loose or being exposed to dust.

Cleaning the Head

If the head becomes dirty, the sound quality will deteriorate and there will be sound dropouts and other imperfections in performance. In this case, the head must be cleaned.



www.DataSheet4U.com

Specifications

General

Power source	14.4 V DC (10.8 – 15.1 V allowable)
Grounding system	Negative type
Max. current consumption	8.5 A
Dimensions	
(mounting size)	178 (W) × 50 (H) × 155 (D) mm
(front face)	188 (W) × 58 (H) × 20 (D) mm
Weight	1.2 kg

Amplifier

Maximum power output	40 W × 4
Continuous power output	22 W × 4
	(DIN45324, +B = 14.4 V)
Load impedance	4 Ω (4 – 8 Ω allowable)
Preout maximum output level/output impedance	2.2 V/1Ω
Equalizer (3-Band Equalizer)	
(Low)	±12 dB
(Mid)	±12 dB
(High)	±12 dB
Loudness contour	
(Low)	+3.5 dB (100 Hz), +3 dB (10 kHz)
(Mid)	+10 dB (100 Hz), +6.5 dB (10 kHz)
(High)	+11 dB (100 Hz), +11 dB (10 kHz)
	(volume: -30 dB)

Cassette player

Tape	Compact cassette tape (C-30 – C-90)
Tape speed	4.8 cm/sec.
Fast forward/rewinding time	Approx. 100 sec. for C-60
Wow & flutter	0.09% (WRMS)
Frequency response	30 – 16,000 Hz (±3 dB)
Stereo separation	45 dB
Signal-to-noise ratio	61 dB (IEC-A network)

FM tuner

Frequency range	87.5 – 108 MHz
Usable sensitivity	
	11 dBf (1.0 μV/75 Ω, mono, S/N: 30 dB)
50 dB quieting sensitivity	16 dBf (1.7 μV/75 Ω, mono)
Signal-to-noise ratio	70 dB (IEC-A network)
Distortion	0.3% (at 65 dBf, 1 kHz, stereo)
Frequency response	30 – 15,000 Hz (±3 dB)
Stereo separation	40 dB (at 65 dBf, 1 kHz)

MW tuner

Frequency range	531 – 1,602 kHz
Usable sensitivity	18 μV (S/N: 20 dB)
Selectivity	50 dB (±9 kHz)

LW tuner

Frequency range	153 – 281 kHz
Usable sensitivity	30 μV (S/N: 20 dB)
Selectivity	50 dB (±9 kHz)

Note:

- Specifications and the design are subject to possible modification without notice due to improvements.

France: tapez 36 15 PIONEER

PIONEER ELECTRONIC CORPORATION

1-4-1 MEGURO, MEGURO-KU, TOKYO 153-8654, JAPAN

PIONEER ELECTRONICS (USA) INC.

P.O. Box 1760, Long Beach, California 90801, U.S.A.

TEL: (800) 421-1404

PIONEER ELECTRONIC (EUROPE) N.V.

Haven 1087 Keetberglaan 1, 9120 Melsele, Belgium

TEL:(0) 3/570.05.11

PIONEER ELECTRONICS AUSTRALIA PTY. LTD.

178-184 Boundary Road, Braeside, Victoria 3195, Australia

TEL: (03) 580-9911

PIONEER ELECTRONICS OF CANADA, INC.

300 Allstate Parkway, Markham, Ontario L3R 0P2, Canada

TEL: (905) 479-4411

PIONEER ELECTRONICS DE MEXICO, S.A. de C.V.

San Lorenzo Num 1009 3er piso Desp. 302

Col. Del Valle, Mexico D.F. C.P. 03100

TEL: 5-688-52-90

Published by Pioneer Electronic Corporation. Copyright © 1999 by Pioneer Electronic Corporation. All rights reserved.