

Dual N-channel MOSFET**KFC6B21B70L
Datasheet**

The information described in this document is the exclusive intellectual property of Nuvoton Technology Corporation Japan and shall not be reproduced without permission from Nuvoton.

Nuvoton is providing document only for reference purposes of KFC6B21B70L based system design.

Nuvoton assumes no responsibility for errors or omissions.

All data and specifications are subject to change without notice.

For additional information or question, please contact Nuvoton Technology Corporation Japan.

www.nuvoton.co.jp

1. GENERAL DESCRIPTION

Gate resistor installed Dual N-channel MOSFET for lithium-ion secondary battery protection circuits.

2. FEATURES

- Source-source On-state Resistance: $R_{SS(on)}$ typ = 4.6 m Ω ($V_{GS} = 3.8$ V)
- CSP (Chip Size Package)
- Halogen-free / RoHS compliant (EU RoHS / UL-94 V-0 / MSL: Level 1)

3. MARKING SYMBOL: X7

4. PACKAGING

Embossed type (Thermo-compression sealing): 10,000 pcs / reel (standard)

5. ABSOLUTE MAXIMUM RATINGS $T_a = 25$ °C

Parameter	Symbol	Rating	Unit
Source-source Voltage	VSS	12	V
Gate-source Voltage	VGS	± 8	V
Source Current	DC ^{*1}	IS1	9.0
	DC ^{*2}	IS2	15.1
	DC ^{*3}	IS3	19.4
	Pulsed ^{*4}	ISp	90
Total Power Dissipation	DC ^{*1}	PD1	0.50
	DC ^{*2}	PD2	1.40
	DC ^{*3}	PD3	2.60
Operating Junction and Storage Temperature Range	Tj, Tstg	- 55 to + 150	°C

6. THERMAL CHARACTERISTICS $T_a = 25$ °C

Parameter	Symbol	Rating	Unit
Thermal Resistance (ch-a)	Rth1 ^{*1}	250	°C / W
	Rth2 ^{*2}	89	
	Rth3 ^{*3}	48	

- Note
- *1 Mounted on FR4 board (25.4 mm x 25.4 mm x t1.0 mm).
FR4 board partially covered with copper pad (22 mm² area, 36 μ m thickness).
 - *2 Mounted on FR4 board (25.4 mm x 25.4 mm x t1.0 mm).
FR4 board fully covered with copper pad (598 mm² area, 36 μ m thickness).
 - *3 Mounted on ceramic board (70 mm x 70 mm x t1.0 mm).
 - *4 t = 10 μ s, Duty Cycle \leq 1 %.

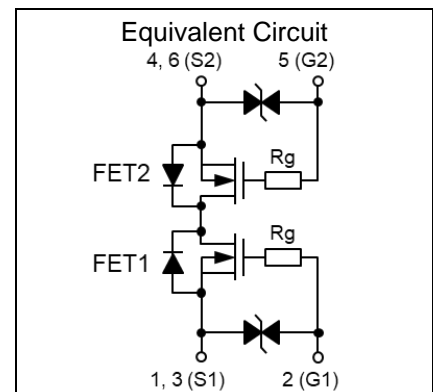
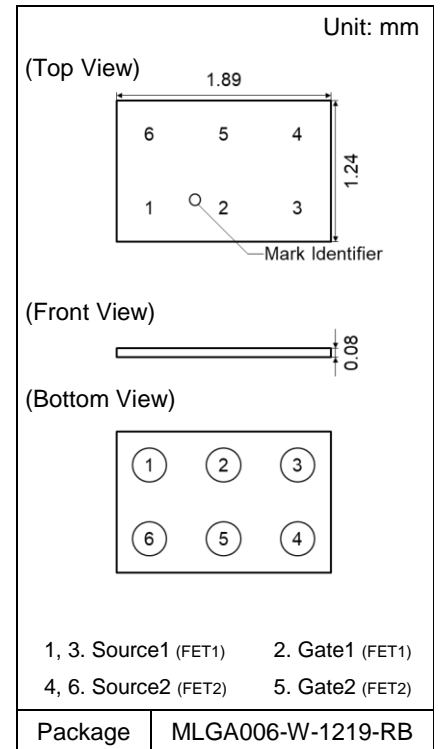

7. ELECTRICAL CHARACTERISTICS Ta = 25 °C ± 3 °C

Parameter	Symbol	Conditions	Min	Typ	Max	Unit
Source-source Breakdown Voltage	VSSS	IS = 1 mA, VGS = 0 V	12			V
Zero Gate Voltage Source Current	ISSS	VSS = 12 V, VGS = 0 V			1	μA
Gate-source Leakage Current	IGSS1	VGS = ± 8 V, VSS = 0 V			± 10	μA
	IGSS2	VGS = ± 5 V, VSS = 0 V			± 1	
Gate-source Threshold Voltage	Vth	IS = 0.26 mA, VSS = 6 V	0.35	0.90	1.40	V
Source-source On-state Resistance	RSS(on)1	IS = 4.5 A, VGS = 4.5 V	2.9	4.2	5.5	mΩ
	RSS(on)2	IS = 4.5 A, VGS = 3.8 V	3.2	4.6	6.1	
	RSS(on)3	IS = 4.5 A, VGS = 3.1 V	3.4	5.4	7.8	
	RSS(on)4	IS = 4.5 A, VGS = 2.5 V	4.4	7.4	13.8	
Body Diode Forward Voltage	VF(s-s)	IF = 4.5 A, VGS = 0 V		0.7	1.0	V
Input Capacitance *1	Ciss	VSS = 10 V, VGS = 0 V, f = 1 kHz		1810		pF
Output Capacitance *1	Coss			300		
Reverse Transfer Capacitance *1	Crss			240		
Turn-on Delay Time *1,*2	td(on)	VDD = 6 V, VGS = 0 to 4 V		2.1		μs
Rise Time *1,*2	tr	IS = 4.5 A		3.1		
Turn-off Delay Time *1,*2	td(off)	VDD = 6 V, VGS = 4 to 0 V		8.8		μs
Fall Time *1,*2	tf	IS = 4.5 A		4.8		
Total Gate Charge *1	Qg	VDD = 6 V		15		nC
Gate-source Charge *1	Qgs	VGS = 0 to 4 V		4.1		
Gate-drain Charge *1	Qgd	IS = 9.0 A		3.3		
Gate Resistance *1	Rg	f = 1 MHz	1100	2000	2900	Ω

Note Measuring methods are based on JAPANESE INDUSTRIAL STANDARD JIS C 7030 Measuring methods for transistors.

*1 Guaranteed by design, not subject to production testing.

*2 Measurement circuit for Turn-on Delay Time / Rise Time / Turn-off Delay Time / Fall Time.

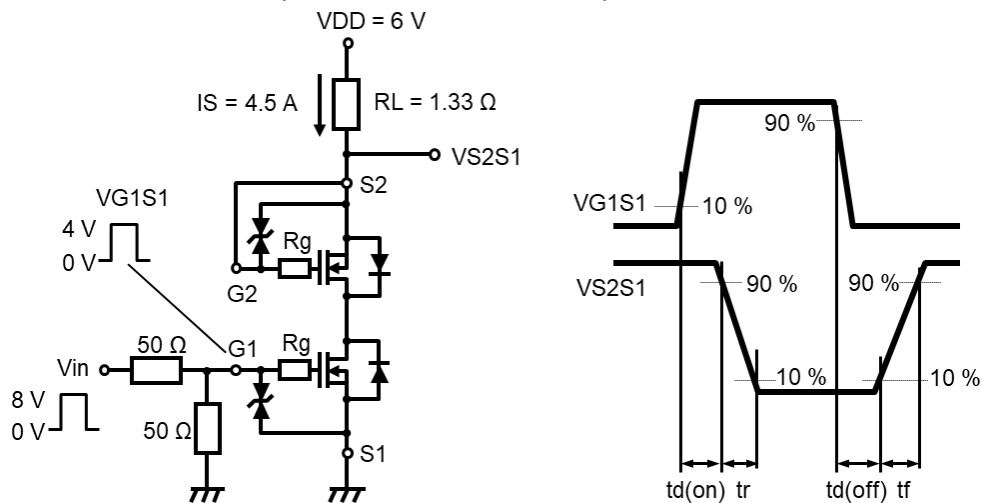

8. ELECTROSTATIC DISCHARGE CHARACTERISTIC Ta = 25 °C ± 3 °C

Standard	Test Type	Symbol	Conditions	Class	Value	Unit
AEC-Q101-001	Human Body Model	HBM	C = 100 pF, R = 1.5 kΩ	H2	> 2 to ≤ 4	kV

9. TECHNICAL DATA (Reference)

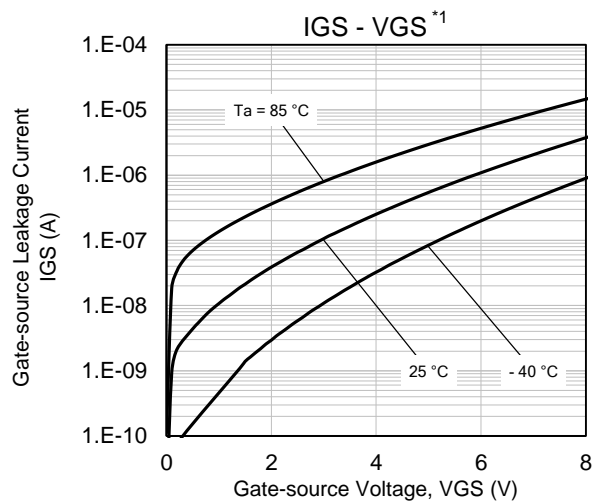
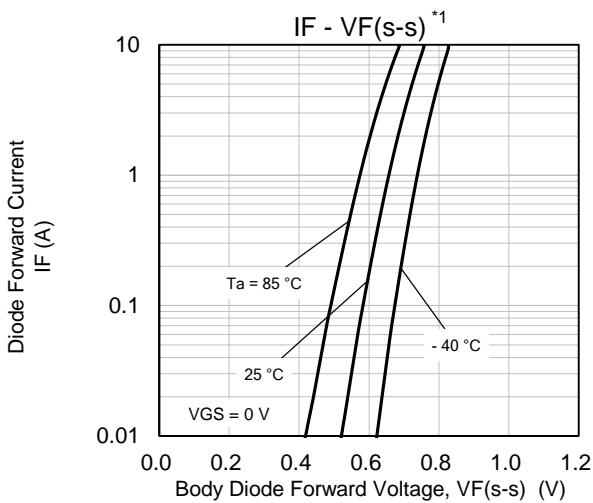
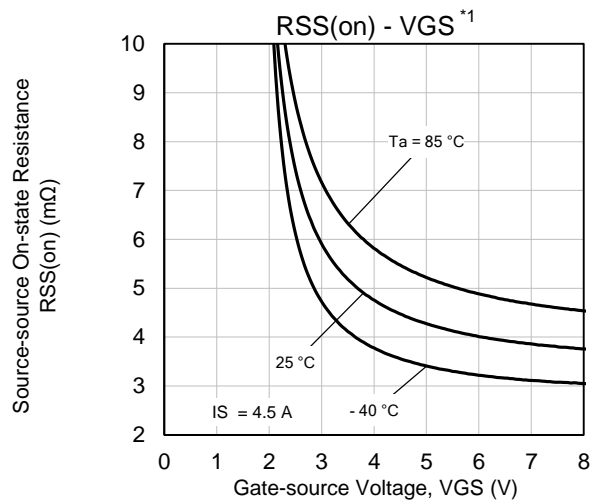
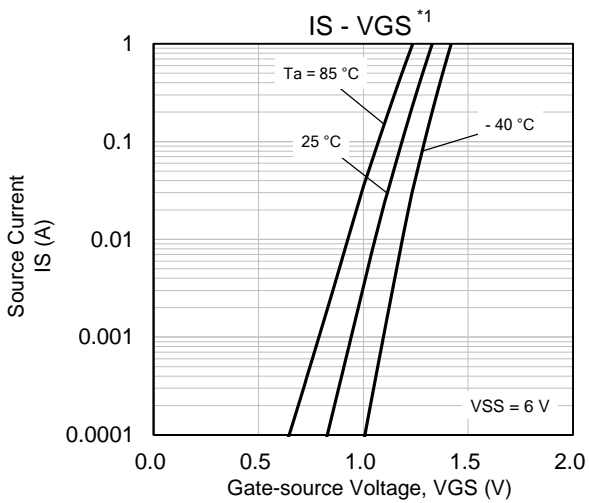
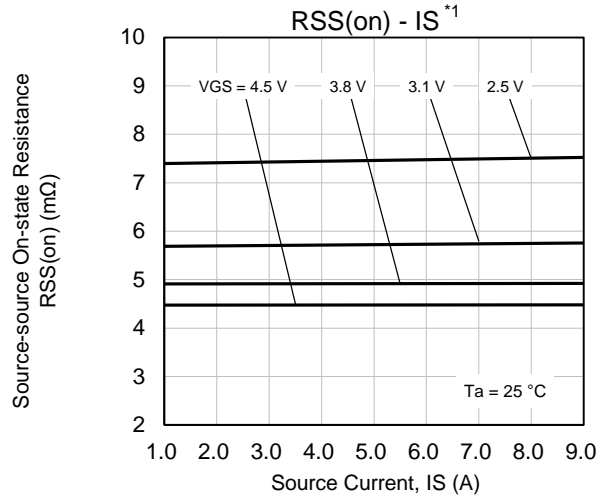
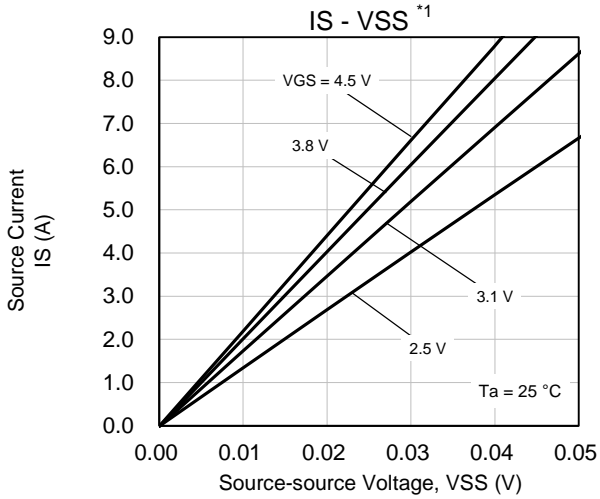

TECHNICAL DATA (Reference)

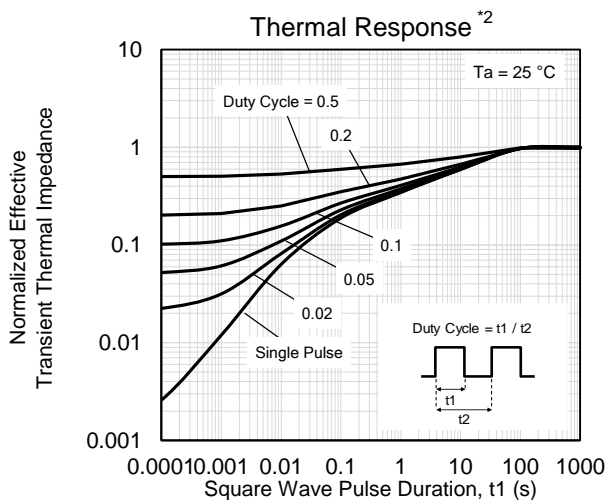
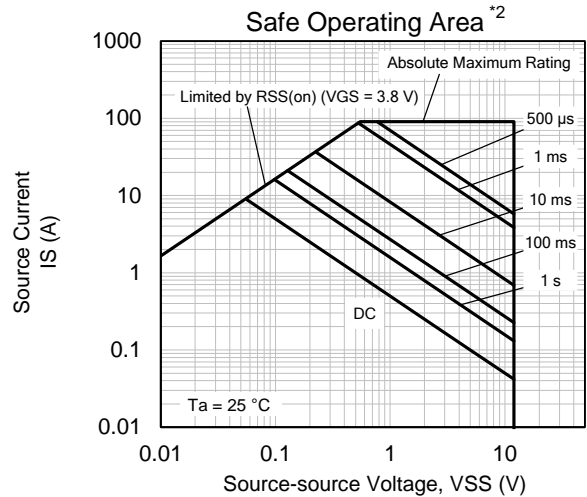
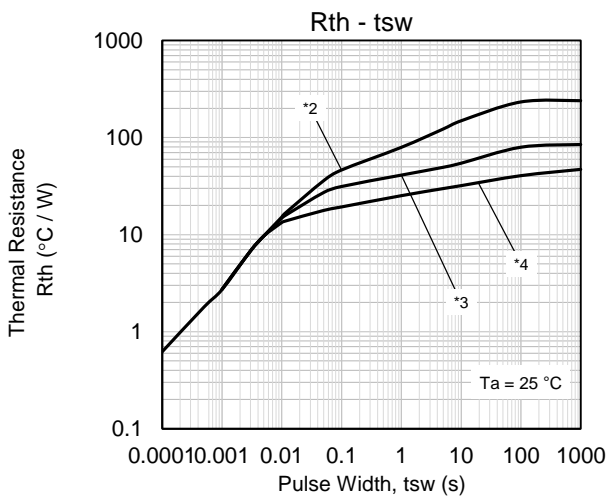
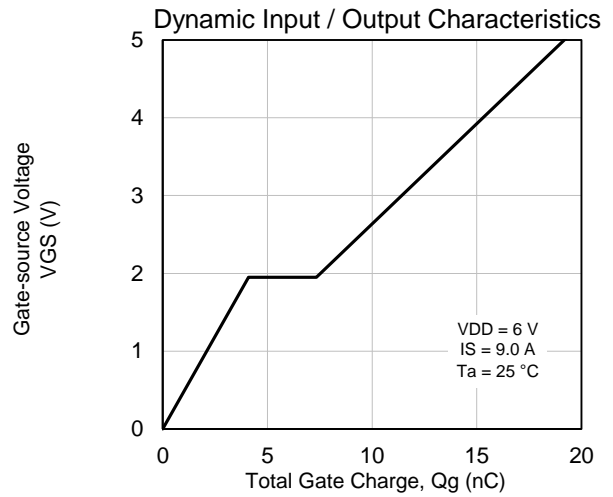
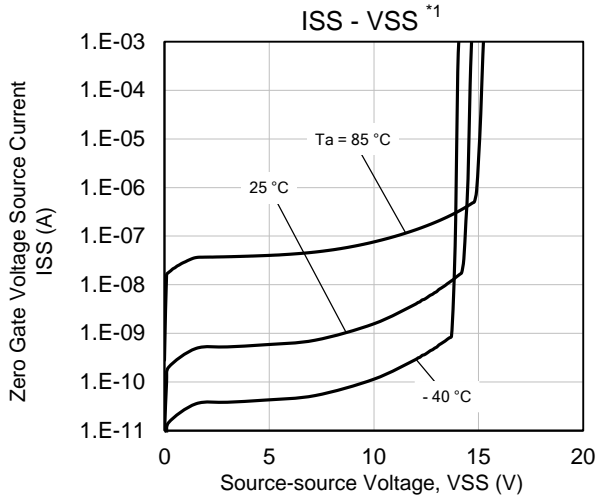

Note

- *1 Pulse measurement.
- *2 Mounted on FR4 board (25.4 mm x 25.4 mm x t1.0 mm). FR4 board partially covered with copper pad (22 mm² area, 36 µm thickness).
- *3 Mounted on FR4 board (25.4 mm x 25.4 mm x t1.0 mm). FR4 board fully covered with copper pad (598 mm² area, 36 µm thickness).
- *4 Mounted on ceramic board (70 mm x 70 mm x t1.0 mm).

10. OUTLINE

(Top View)

Unit: mm

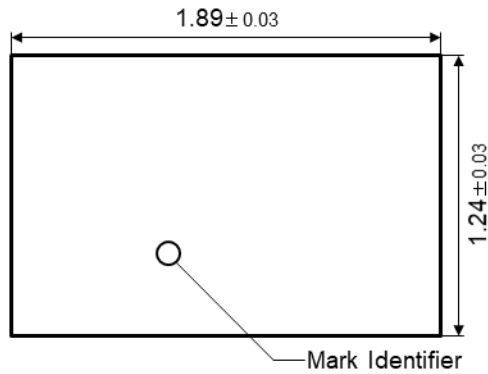

(Front View)

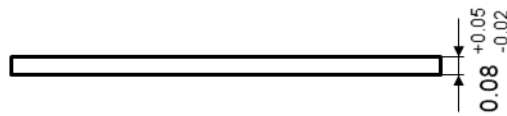

(Bottom View)

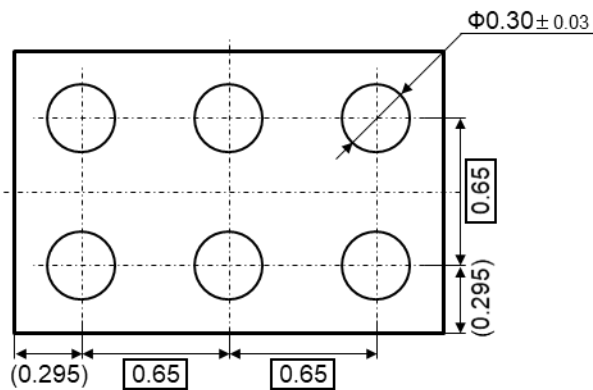

11. LAND & STENCIL PATTERN (Reference)

Unit: mm

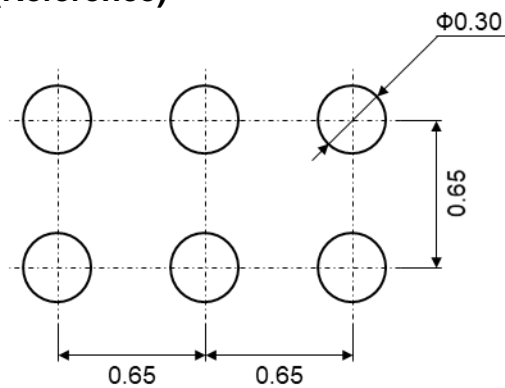

Important notice:

Solder Mask Defined (SMD) pattern is strongly recommended for pad design.
Please check the information in the Nuvoton WL-CSP Application Notes about mounting process.

12. REVISION HISTORY

Date	Revision	Description
2021.9.27	1.00	1. Initially issued.

Request for your special attention and precautions in using the technical information and semiconductors described in this book

(1) If any of the products or technical information described in this book is to be exported or provided to non-residents, the laws and regulations of the exporting country, especially, those with regard to security export control, must be observed.

(2) The technical information described in this book is intended only to show the main characteristics and application circuit examples of the products. No license is granted in and to any intellectual property right or other right owned by Nuvoton Technology Corporation Japan or any other company. Therefore, no responsibility is assumed by our company as to the infringement upon any such right owned by any other company which may arise as a result of the use of technical information described in this book.

(3) The products described in this book are intended to be used for general applications (such as office equipment, communications equipment, measuring instruments and household appliances), or for specific applications as expressly stated in this book.

It is to be understood that our company shall not be held responsible for any damage caused as a result of the following special applications: Special applications (such as for automotive, airplanes, aerospace, transport equipment, traffic signaling equipment, combustion equipment, medical equipment and safety devices) in which exceptional quality and reliability are required, or if the failure or malfunction of the products may directly jeopardize life or harm the human body.

It is to be understood that our company shall not be held responsible for any damage incurred as a result of or in connection with your using the products described in this book for any special application, unless our company agrees to your using the products in this book for any special application.

(4) When designing your equipment, comply with the range of absolute maximum rating and the guaranteed operating conditions (operating power supply voltage and operating environment etc.). Especially, please be careful not to exceed the range of absolute maximum rating on the transient state, such as power-on, power-off and mode-switching. Other-wise, we will not be liable for any defect which may arise later in your equipment. Please pay attention about moisture proof because the product is unmolded device. It is not special consideration to use in environmental which is high temperature or high humidity where dew condensation may occur. Any use and storage under the circumstance may affect the performance of the product. Prior confirmation of performance and reliability is requested to customers.

Even when the products are used within the guaranteed values, take into the consideration of incidence of break down and failure mode, possible to occur to semiconductor products. Measures on the systems such as redundant design, arresting the spread of fire or preventing glitch are recommended in order to prevent physical injury, fire, social damages, for example, by using the products.

(5) Please pay attention about breakdown and characteristics change due to external factors (ESD, EOS, thermal stress and mechanical stress, touching the product with bare hands) at the time of handling, mounting or at customer's process. We do not guarantee quality for disassembled products or the product re-mounted after removing from the mounting board. When using products for which damp-proof packing is required, satisfy the conditions, such as shelf life and the elapsed time since first opening the packages.

(6) When reselling products described in this book to other companies without our permission and receiving any claim of request from the resale destination, please understand that customers will bear the burden.

(7) This book may be not reprinted or reproduced whether wholly or partially, without the prior written permission of our company.

Important Notice

Nuvoton Products are neither intended nor warranted for usage in systems or equipment, any malfunction or failure of which may cause loss of human life, bodily injury or severe property damage. Such applications are deemed, "Insecure Usage".

Insecure usage includes, but is not limited to: equipment for surgical implementation, atomic energy control instruments, airplane or spaceship instruments, the control or operation of dynamic, brake or safety systems designed for vehicular use, traffic signal instruments, all types of safety devices, and other applications intended to support or sustain life.

All Insecure Usage shall be made at customer's risk, and in the event that third parties lay claims to Nuvoton as a result of customer's Insecure Usage, customer shall indemnify the damages and liabilities thus incurred by Nuvoton.

*Please note that all data and specifications are subject to change without notice.
All the trademarks of products and companies mentioned in this datasheet belong to their respective owners.*