

# OKI electronic components

## KGF1521

### Small-Signal Amplifier

#### GENERAL DESCRIPTION

The KGF1521 is a high-performance GaAs FET small-signal amplifier for L-band frequencies that features low voltage operation, low current operation, low noise, and low distortion. The KGF1521 specifications are guaranteed to a fixed matching circuit for 3 V and 1.9 GHz; external impedance-matching circuits are also required. Because of its high 3rd-order intercept point, even at its low operating current, the KGF1521 is ideal as a small-signal amplifier for L-band personal handy phones, such as digital keying cordless phones that require low intermodulation properties.

#### FEATURES

- Low voltage and low current operation: 3 V, 2.5 mA (max.)
- Specifications guaranteed to a fixed matching circuit for 3 V, 1.9 GHz
- Low noise figure: 1.8 dB (typ.) at 1.9 GHz
- High linear gain: 12.5 dB (typ.) at 1.9 GHz
- High output power: 1 dB compression point = 0 dBm (typ.) at 1.9 GHz
- Low distortion: 3rd-order intercept point = 12 dBm (typ.) at 1.9 GHz
- Self-bias circuit configuration with built-in source capacitor
- Package: 4PSOP

#### PACKAGE DIMENSIONS

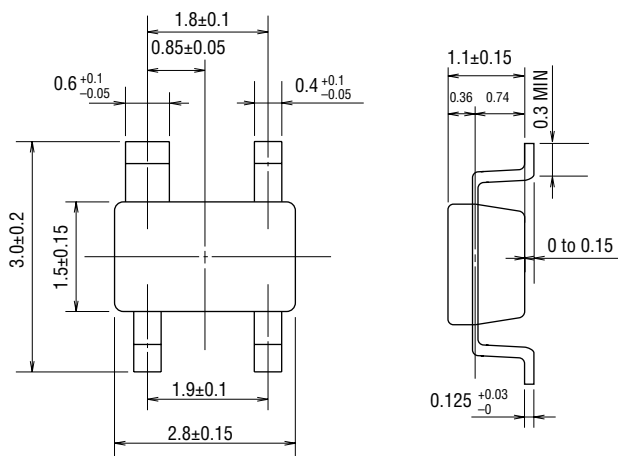

(Unit: mm)

Package material	Epoxy resin
Lead frame material	42 alloy
Pin treatment	Solder plating
Solder plate thickness	5 μm or more

### MARKING

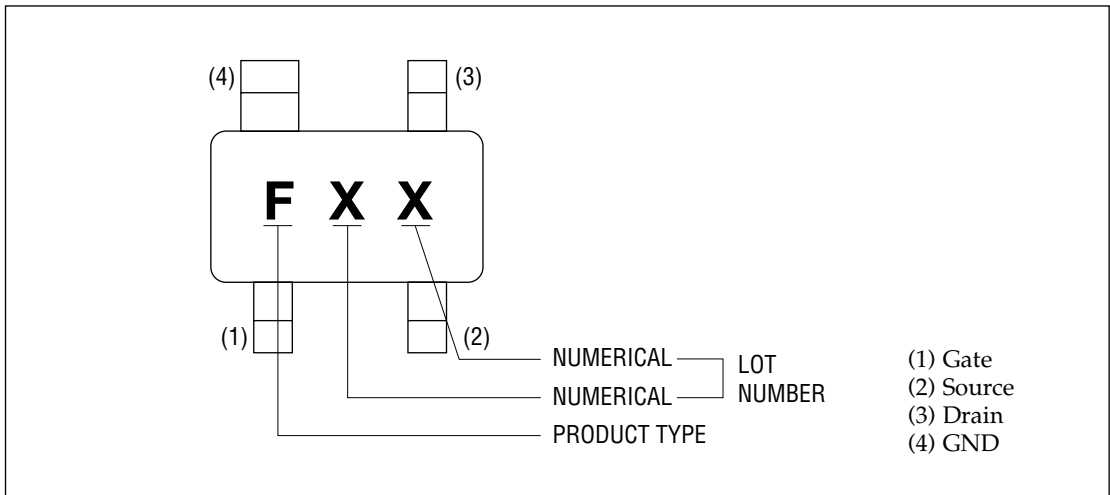

### CIRCUIT

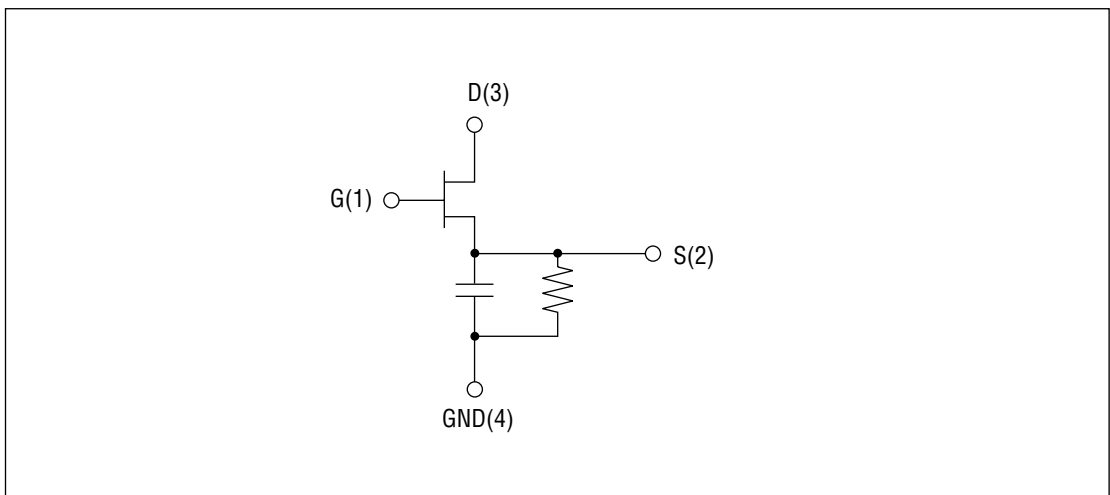

**ABSOLUTE MAXIMUM RATINGS**

Item	Symbol	Condition	Unit	Min.	Max.
Drain-source voltage	$V_{DS}$	$T_a = 25^\circ\text{C}$	V	—	4.0
Gate-source voltage	$V_{GS}$	$T_a = 25^\circ\text{C}$	V	-3.0	0.4
Drain current	$I_{DS}$	$T_a = 25^\circ\text{C}$	mA	—	50
Total power dissipation	$P_{tot}$	$T_a = 25^\circ\text{C}$	mW	—	200
Channel temperature	$T_{ch}$	—	$^\circ\text{C}$	—	150
Storage temperature	$T_{stg}$	—	$^\circ\text{C}$	-45	125

**ELECTRICAL CHARACTERISTICS**

(Ta = 25°C)

Item	Symbol	Condition	Unit	Min.	Typ.	Max.
Gate-source leakage current	$I_{GSS}$	$V_{GS} = -3\text{ V}$	$\mu\text{A}$	—	—	30
Gate-drain leakage current	$I_{GDO}$	$V_{GD} = -6\text{ V}$	$\mu\text{A}$	—	—	30
Drain-source leakage current	$I_{DS(off)}$	$V_{DS} = 3\text{ V}, V_{GS} = -2\text{ V}$	$\mu\text{A}$	—	—	30
Drain current	$I_{DSS}$	$V_{DS} = 3\text{ V}, V_{GS} = 0\text{ V}$	mA	15	25	—
Operating current	$I_D$	(*1), $P_{IN} = -20\text{ dBm}$	mA	—	2.0	2.5
Gate-source cut-off voltage	$V_{GS(off)}$	$V_{DS} = 3\text{ V}, I_{DS} = 100\ \mu\text{A}$	V	-1.4	—	-0.6
Transconductance	$g_m$	$V_{DS} = 3\text{ V}, I_{DS} = 2\text{ mA}$	mS	14	17	—
Noise figure	F	(*1)	dB	—	1.8	2.5
Linear gain	$G_{LIN}$	(*1), $P_{IN} = -20\text{ dBm}$	dB	11.0	12.5	—
Output power	$P_{O1}$	(*1)	dBm	-3.0	0	—
Third-order intercept point	$IP_3$	(*2), $f_2 = 1.901\text{ GHz}$	dBm	—	12	—

\*1 Self-bias condition:  $V_{DD} = 3\text{ V} \pm 0.3\text{ V}, V_G = 0\text{ V}, f = 1.9\text{ GHz}$

RF CHARACTERISTICS

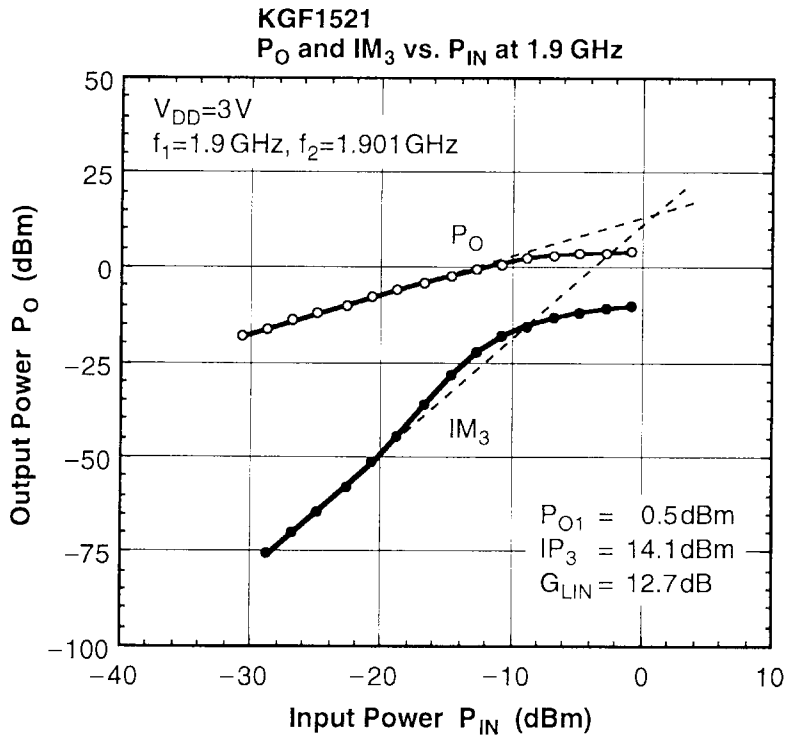
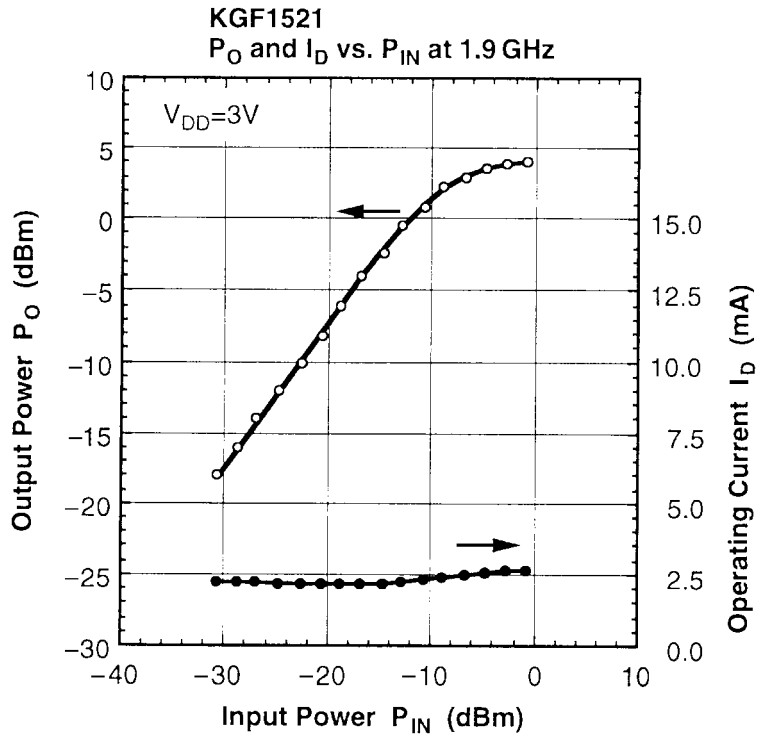

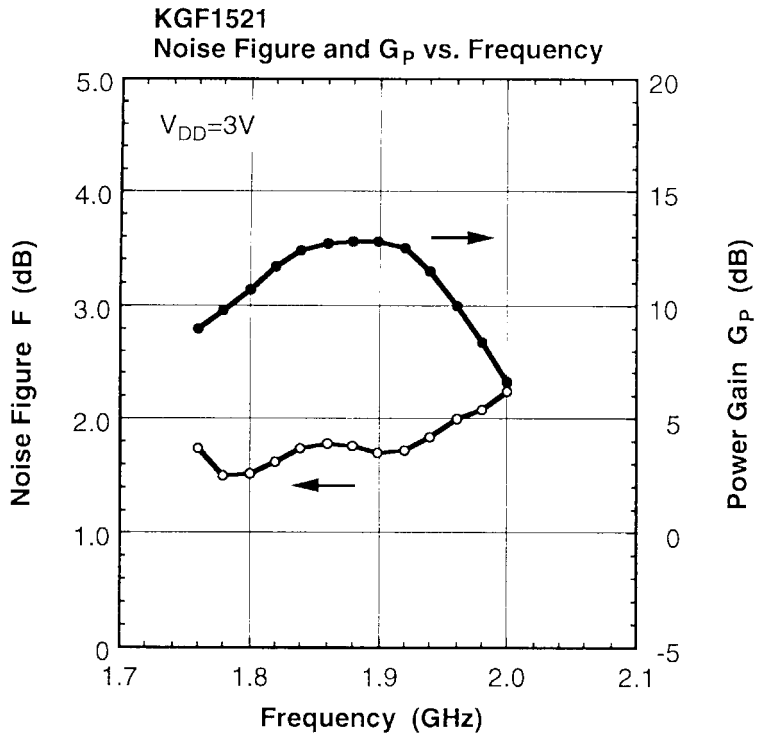

## Typical S Parameters

 $V_{DD} = 3\text{ V}$ ,  $I_D = 2.23\text{ mA}$ 

Freq(MHz)	MAG(S <sub>11</sub> )	ANG(S <sub>11</sub> )	MAG(S <sub>21</sub> )	ANG(S <sub>21</sub> )	MAG(S <sub>12</sub> )	ANG(S <sub>12</sub> )	MAG(S <sub>22</sub> )	ANG(S <sub>22</sub> )
500.0	1.006	-9.13	1.330	176.30	0.010	77.66	0.939	-6.40
600.0	1.004	-10.96	1.338	172.44	0.012	75.14	0.937	-7.42
700.0	1.001	-12.83	1.346	168.98	0.013	74.67	0.934	-8.59
800.0	0.998	-14.68	1.353	165.93	0.015	74.75	0.933	-9.60
900.0	0.995	-16.53	1.354	163.08	0.016	74.68	0.932	-10.71
1000.0	0.992	-18.33	1.359	160.07	0.018	72.86	0.930	-11.75
1100.0	0.987	-20.18	1.359	157.16	0.018	73.49	0.927	-12.88
1200.0	0.983	-22.02	1.369	154.84	0.020	72.57	0.926	-13.89
1300.0	0.978	-23.88	1.374	152.28	0.021	71.18	0.925	-14.99
1400.0	0.972	-25.70	1.376	149.79	0.022	70.96	0.922	-16.04
1500.0	0.966	-27.62	1.388	146.67	0.022	71.48	0.920	-17.08
1600.0	0.959	-29.46	1.397	144.51	0.022	70.80	0.918	-18.12
1700.0	0.950	-31.22	1.393	141.98	0.023	70.04	0.914	-18.95
1800.0	0.941	-33.22	1.409	138.88	0.023	71.52	0.911	-20.20
1900.0	0.935	-35.13	1.418	136.15	0.023	72.15	0.910	-21.19
2000.0	0.924	-37.04	1.434	133.84	0.022	75.12	0.905	-22.16
2100.0	0.915	-38.95	1.440	131.23	0.023	80.13	0.903	-23.29
2200.0	0.905	-40.60	1.435	128.21	0.024	80.50	0.900	-24.24
2300.0	0.893	-42.34	1.440	125.19	0.023	82.84	0.894	-25.15
2400.0	0.881	-44.23	1.458	122.85	0.023	87.86	0.892	-26.13
2500.0	0.866	-15.91	1.448	120.01	0.023	91.51	0.887	-26.95
2600.0	0.852	-47.73	1.455	116.96	0.024	97.20	0.883	-27.96
2700.0	0.837	-49.40	1.447	114.13	0.025	105.76	0.879	-28.80
2800.0	0.821	-51.16	1.467	111.27	0.027	110.78	0.874	-29.63
2900.0	0.806	-52.74	1.454	108.42	0.029	118.12	0.871	-30.58
3000.0	0.790	-54.25	1.462	105.45	0.032	122.68	0.868	-31.21

Typical S Parameters

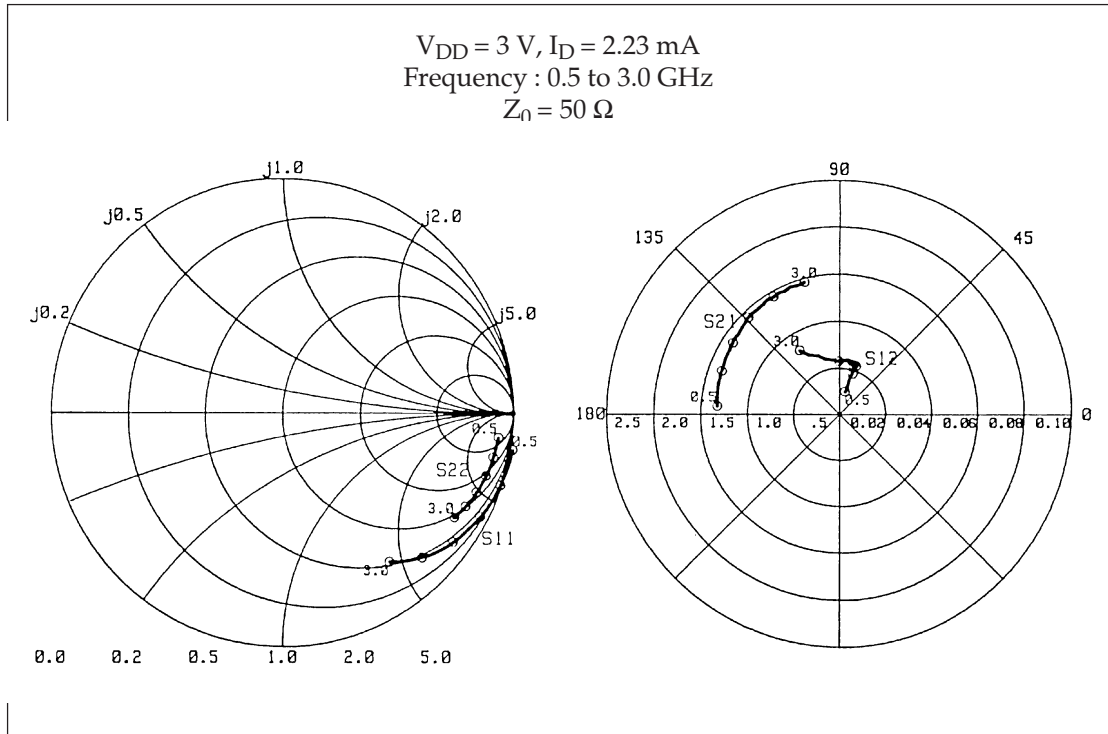

Test Circuit and Bias Configuration for KGF1521 at 1.9 GHz

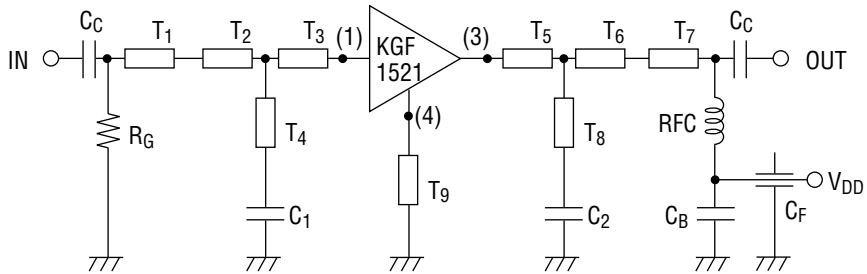

$T_1$ :  $Z_0 = 75 \Omega$ ,  $E = 23 \text{ deg}$        $T_5$ :  $Z_0 = 100 \Omega$ ,  $E = 87 \text{ deg}$   
 $T_2$ :  $Z_0 = 100 \Omega$ ,  $E = 2 \text{ deg}$        $T_6$ :  $Z_0 = 100 \Omega$ ,  $E = 25 \text{ deg}$   
 $T_3$ :  $Z_0 = 100 \Omega$ ,  $E = 68 \text{ deg}$        $T_7$ :  $Z_0 = 75 \Omega$ ,  $E = 20 \text{ deg}$   
 $T_4 = T_8$ :  $Z_0 = 100 \Omega$ ,  $E = 10 \text{ deg}$        $T_9$ :  $Z_0 = 100 \Omega$ ,  $E = 5 \text{ deg}$   
 $C_1 = 1.40 \text{ pF}$ ,  $C_2 = 1.35 \text{ pF}$   
 $C_{C(\text{DC Block})} = 1000 \text{ pF}$ ,  $C_{B(\text{By-pass})} = 1000 \text{ pF}$ ,  $C_{F(\text{Feed through})} = 1000 \text{ pF}$   
 $\text{RFC} = 60 \text{ nH}$ ,  $R_G = 1000 \Omega$