

KGPE-D16



Motherboard

Contents

Notices.....	vii
Safety information	viii
About this guide	x
KGPE-D16 specifications summary.....	xii
Chapter 1: Product introduction	
1.1 Welcome!	1-3
1.2 Package contents.....	1-3
1.3 Serial number label.....	1-4
1.4 Special features.....	1-4
1.4.1 Product highlights	1-4
1.4.2 Innovative ASUS features	1-6
Chapter 2: Hardware information	
2.1 Before you proceed	2-3
2.2 Motherboard overview.....	2-6
2.2.1 Placement direction	2-6
2.2.2 Screw holes	2-6
2.2.3 Motherboard layouts	2-7
2.2.4 Layout contents.....	2-8
2.3 Central Processing Unit (CPU)	2-10
2.3.1 Installing the CPU	2-10
2.3.2 Installing the CPU heatsink and fan	2-13
2.4 System memory	2-16
2.4.1 Overview	2-16
2.4.2 Memory Configurations.....	2-17
2.4.3 Installing a DIMM	2-19
2.4.4 Removing a DIMM	2-19
2.5 Expansion slots.....	2-20
2.5.1 Installing an expansion card	2-20
2.5.2 Configuring an expansion card	2-20
2.5.3 Interrupt assignments	2-21
2.5.4 MIO/PCIE slot	2-22
2.5.5 PCI Express x16 slots (x16 link; x8 link)	2-22
2.5.6 PCI slot	2-22
2.5.7 PIKE slot	2-22

Contents

- 2.5.8 Installing an ASUS PIKE RAID card 2-23
- 2.5.9 Installing ASMB4 management board..... 2-24
- 2.5.10 Connecting the thermal sensor cable 2-24
- 2.5.11 Installing the audio card 2-25
- 2.6 Jumpers 2-26**
- 2.7 Connectors 2-31**
 - 2.7.1 Rear panel connectors 2-31
 - 2.7.2 Internal connectors 2-32

- Chapter 3: Powering up**
 - 3.1 Starting up for the first time..... 3-3**
 - 3.2 Powering off the computer..... 3-4**
 - 3.2.1 Using the OS shut down function..... 3-4
 - 3.2.2 Using the dual function power switch..... 3-4

- Chapter 4: BIOS setup**
 - 4.1 Managing and updating your BIOS 4-3**
 - 4.1.1 ASUS EZ Flash 2 utility..... 4-3
 - 4.1.2 BUPDATER utility..... 4-4
 - 4.1.3 ASUS CrashFree BIOS 3 utility 4-6
 - 4.2 BIOS setup program 4-7**
 - 4.2.1 BIOS menu screen..... 4-8
 - 4.2.2 Menu bar..... 4-8
 - 4.2.3 Navigation keys..... 4-8
 - 4.2.4 Menu items 4-9
 - 4.2.5 Submenu items 4-9
 - 4.2.6 Configuration fields 4-9
 - 4.2.7 Pop-up window 4-9
 - 4.2.8 Scroll bar..... 4-9
 - 4.2.9 General help 4-9
 - 4.3 Main menu 4-10**
 - 4.3.1 System Time [xx:xx:xx] 4-10
 - 4.3.2 System Date [Day xx/xx/xxxx]..... 4-10
 - 4.3.3 SATA1–6 4-11
 - 4.3.4 Storage Configuration 4-12
 - 4.3.5 System Information 4-13

Contents

4.4	Advanced menu	4-15
4.4.1	CPU Configuration	4-15
4.4.2	Chipset Configuration	4-17
4.4.3	Onboard Devices Configuration	4-27
4.4.4	USB Configuration	4-28
4.4.5	PCI/PnP	4-29
4.4.6	Event Log Configuration	4-29
4.5	Server menu	4-30
4.6	Power menu	4-32
4.6.1	Suspend Mode [Auto]	4-32
4.6.2	Repost Video on S3 Resume [No]	4-32
4.6.3	ACPI 2.0 Support [ACPI v2.0]	4-32
4.6.4	ACPI APIC support [Enabled]	4-32
4.6.5	APM Configuration	4-33
4.6.6	Hardware Monitor	4-34
4.7	Boot menu	4-36
4.7.1	Boot Device Priority	4-36
4.7.2	Hard Disk Drives; CDROM Drives	4-36
4.7.3	Boot Settings Configuration	4-37
4.7.4	Security	4-38
4.8	Tools menu	4-40
4.9	Exit menu	4-41
 Chapter 5: RAID configuration		
5.1	Setting up RAID	5-3
5.1.1	RAID definitions	5-3
5.1.2	Installing hard disk drives.....	5-4
5.1.3	Setting the RAID item in BIOS	5-4
5.2	FastBuild Utility	5-5
5.2.1	Creating a RAID set	5-6
5.2.2	Deleting a RAID set	5-12
5.2.3	Viewing the Drive Assignment.....	5-14
5.2.4	Viewing the Controller Configuration.....	5-15

Contents

Chapter 6: Driver installation

6.1	RAID driver installation	6-3
6.1.1	Creating a RAID driver disk	6-3
6.1.2	Installing the RAID controller driver	6-5
6.2	AMD® processor driver installation	6-15
6.3	LAN driver installation.....	6-16
6.4	ATI SM Bus controller driver installation.....	6-20
6.5	Display driver installation	6-21
6.6	Management applications and utilities installation	6-24
6.6.1	Running the support DVD	6-24
6.6.2	Drivers menu.....	6-24
6.6.3	Utilities menu	6-25
6.6.4	Make disk menu.....	6-25
6.6.5	Contact information.....	6-25

Appendix: Reference information

A.1	KGPE-D16 block diagram.....	A-3
------------	------------------------------------	------------

Notices

Federal Communications Commission Statement

This device complies with Part 15 of the FCC Rules. Operation is subject to the following two conditions:

- This device may not cause harmful interference, and
- This device must accept any interference received including interference that may cause undesired operation.

This equipment has been tested and found to comply with the limits for a Class B digital device, pursuant to Part 15 of the FCC Rules. These limits are designed to provide reasonable protection against harmful interference in a residential installation. This equipment generates, uses and can radiate radio frequency energy and, if not installed and used in accordance with manufacturer's instructions, may cause harmful interference to radio communications. However, there is no guarantee that interference will not occur in a particular installation. If this equipment does cause harmful interference to radio or television reception, which can be determined by turning the equipment off and on, the user is encouraged to try to correct the interference by one or more of the following measures:

- Reorient or relocate the receiving antenna.
- Increase the separation between the equipment and receiver.
- Connect the equipment to an outlet on a circuit different from that to which the receiver is connected.
- Consult the dealer or an experienced radio/TV technician for help.



The use of shielded cables for connection of the monitor to the graphics card is required to assure compliance with FCC regulations. Changes or modifications to this unit not expressly approved by the party responsible for compliance could void the user's authority to operate this equipment.

Canadian Department of Communications Statement

This digital apparatus does not exceed the Class B limits for radio noise emissions from digital apparatus set out in the Radio Interference Regulations of the Canadian Department of Communications.

This class B digital apparatus complies with Canadian ICES-003.

REACH

Complying with the REACH (Registration, Evaluation, Authorization, and Restriction of Chemicals) regulatory framework, we publish the chemical substances in our products at ASUS REACH website at <http://csr.asus.com/english/REACH.htm>.

Safety information

Electrical safety

- To prevent electrical shock hazard, disconnect the power cable from the electrical outlet before relocating the system.
- When adding or removing devices to or from the system, ensure that the power cables for the devices are unplugged before the signal cables are connected. If possible, disconnect all power cables from the existing system before you add a device.
- Before connecting or removing signal cables from the motherboard, ensure that all power cables are unplugged.
- Seek professional assistance before using an adapter or extension cord. These devices could interrupt the grounding circuit.
- Make sure that your power supply is set to the correct voltage in your area. If you are not sure about the voltage of the electrical outlet you are using, contact your local power company.
- If the power supply is broken, do not try to fix it by yourself. Contact a qualified service technician or your retailer.

Operation safety

- Before installing the motherboard and adding devices on it, carefully read all the manuals that came with the package.
- Before using the product, make sure all cables are correctly connected and the power cables are not damaged. If you detect any damage, contact your dealer immediately.
- To avoid short circuits, keep paper clips, screws, and staples away from connectors, slots, sockets and circuitry.
- Avoid dust, humidity, and temperature extremes. Do not place the product in any area where it may become wet.
- Place the product on a stable surface.
- If you encounter technical problems with the product, contact a qualified service technician or your retailer.



DO NOT throw the motherboard in municipal waste. This product has been designed to enable proper reuse of parts and recycling. This symbol of the crossed out wheeled bin indicates that the product (electrical and electronic equipment) should not be placed in municipal waste. Check local regulations for disposal of electronic products.



DO NOT throw the mercury-containing button cell battery in municipal waste. This symbol of the crossed out wheeled bin indicates that the battery should not be placed in municipal waste.

Australia statement notice

From 1 January 2012 updated warranties apply to all ASUS products, consistent with the Australian Consumer Law. For the latest product warranty details please visit <http://support.asus.com>. Our goods come with guarantees that cannot be excluded under the Australian Consumer Law. You are entitled to a replacement or refund for a major failure and compensation for any other reasonably foreseeable loss or damage. You are also entitled to have the goods repaired or replaced if the goods fail to be of acceptable quality and the failure does not amount to a major failure.

If you require assistance please call ASUS Customer Service 1300 2787 88 or visit us at <http://support.asus.com>

About this guide

This user guide contains the information you need when installing and configuring the motherboard.

How this guide is organized

This user guide contains the following parts:

- **Chapter 1: Product introduction**
This chapter describes the features of the motherboard and the new technologies it supports.
- **Chapter 2: Hardware information**
This chapter lists the hardware setup procedures that you have to perform when installing system components. It includes description of the switches, jumpers, and connectors on the motherboard.
- **Chapter 3: Powering up**
This chapter describes the power up sequence and ways of shutting down the system.
- **Chapter 4: BIOS setup**
This chapter tells how to change system settings through the BIOS Setup menus. Detailed descriptions of the BIOS parameters are also provided.
- **Chapter 5: RAID configuration**
This chapter provides instructions for setting up, creating, and configuring RAID sets using the available utilities.
- **Chapter 6: Driver installation**
This chapter provides instructions for installing the necessary drivers for different system components.

Where to find more information

Refer to the following sources for additional information and for product and software updates.

1. **ASUS websites**
The ASUS website provides updated information on ASUS hardware and software products. Refer to the ASUS contact information.
2. **Optional documentation**
Your product package may include optional documentation, such as warranty flyers, that may have been added by your dealer. These documents are not part of the standard package.

Conventions used in this guide

To make sure that you perform certain tasks properly, take note of the following symbols used throughout this manual.



DANGER/WARNING: Information to prevent injury to yourself when trying to complete a task.



CAUTION: Information to prevent damage to the components when trying to complete a task.



IMPORTANT: Instructions that you **MUST** follow to complete a task.



NOTE: Tips and additional information to help you complete a task.

Typography

Bold text

Indicates a menu or an item to select.

Italics

Used to emphasize a word or a phrase.

<Key>

Keys enclosed in the less-than and greater-than sign means that you must press the enclosed key.

Example: <Enter> means that you must press the Enter or Return key.

<Key1+Key2+Key3>

If you must press two or more keys simultaneously, the key names are linked with a plus sign (+).

Example: <Ctrl+Alt+Del>

Command

Means that you must type the command exactly as shown, then supply the required item or value enclosed in brackets.

Example: At the DOS prompt, type the command line: **format A:/S**

KGPE-D16 specifications summary

Processor Support / System Bus		2 x socket G34 (LGA 1944) 4/8/12/16 Core AMD® Opteron™ 6300 Series 4/8/12/16 Core AMD® Opteron™ 6200 Series 8/12 Core AMD® Opteron™ 6100 Series * Please check http://www.asus.com/server_workstation/ for the latest update HyperTransport™ Technology 3.0, 6.4 GT/s per link (triple link)
Core Logic		Northbridge: AMD® SR5690 Southbridge: AMD® SP5100
Form Factor		SSI EEB, 12" x 13"
ASUS Features	Fan Speed Control	V
	Rack Ready (Rack and Pedestal dual use)	V
Memory	Total Slots	16 (4-channel per CPU)
	Capacity	Maximum up to 256GB (RDIMM) Maximum up to 64GB (UDIMM)
	Memory Type	DDR3 800/1066/1333/1600 UDIMM with ECC / non ECC DDR3 800/1066/1333/1600 RDIMM * DDR3 1600 can only be supported with AMD® Opteron™ 6300/6200 series processor
	Memory Size	1GB, 2GB, 4GB, 8GB, 16GB (RDIMM) 1GB, 2GB, 4GB (UDIMM)
Expansion Slots (follow SSI Location #)	Total PCI/PCI-X/PCI-E Slots	6
	Slot Location 1	1 x PCI 32bit/33 MHz
	Slot Location 2	1 x PCI-E x16 (Gen2 x8 Link)
	Slot Location 3	1 x PCI-E x16 (Gen2 x16 Link) (Auto switch to x8 Link if slot 2 is occupied)
	Slot Location 4	1 x PCI-E x8 (Gen2 x4 Link)
	Slot Location 5	1 x PCI-E x16 (Gen2 x16 Link)
	Slot Location 6	1 x PCI-E x16 (Gen2 x16 Link for 1U FH/FL Card) (Auto turn off if slot 5 is occupied; MIO supported)
	Additional Slot 1	1* PIKE Slot for Storage expansion

(continued on the next page)

KGPE-D16 specifications summary

Management Solution	Out of Band Remote Management	Optional ASMB4-iKVM for KVM-over-Internet
Monitoring	CPU Temperature	V
	FAN RPM	V
Environment	Operation temperature: 10°C—35°C Non operation temperature: -40°C—70°C Non operation humidity: 20%—90% (Non condensing)	

*Specifications are subject to change without notice.



DO NOT touch the Northbridge chipset! The Northbridge chipset may become overheated. Remember to provide sufficient air flow to keep the system stable.

This chapter describes the motherboard features and the new technologies it supports.

1 Product introduction

1.1 Welcome!

Thank you for buying an ASUS® KGPE-D16 motherboard!

The motherboard delivers a host of new features and latest technologies, making it another standout in the long line of ASUS quality motherboards!

Before you start installing the motherboard, and hardware devices on it, check the items in your package with the list below.

1.2 Package contents

Check your motherboard package for the following items.

		Standard Gift Box Pack	Standard Bulk Pack
Cables	SATA data cable	6	--
Accessories	IO shield	1	1
Application CD	Support CD	1	1
Documentation	User Guide	1	1
Packing Qty.		1pcs per carton	10pcs per carton



If any of the above items is damaged or missing, contact your retailer.

Optional items	Description
PIKE 1064E	LSI 4 port SAS RAID card
PIKE 1068E	LSI 8 port SAS RAID card
PIKE 1078	LSI 8 port SAS RAID card with Hardware RAID 5, 6, 50, 60
PIKE 6480	Marvell 8 port SAS RAID card
PIKE 2008	LSI 8 port SAS2 RAID card
ASMB4-iKVM	Remote Management solution provides KVM over IP solution.
ASUS MIO audio card	Discrete 8 channel audio card provides clearest high quality sounds

1.3 Serial number label

Before requesting support from the ASUS Technical Support team, you must take note of the motherboard's serial number containing 12 characters **xxS2xxxxxxxx** shown as the figure below. With the correct serial number of the product, ASUS Technical Support team members can then offer a quicker and satisfying solution to your problems.



1.4 Special features

1.4.1 Product highlights

Latest processor technology

This motherboard supports the latest AMD® Opteron™ 6300/6200/6100 series processors in LGA 1944 package with integrated memory controller to support 4-channel (8 DIMM per CPU) DDR3 memory. AMD® Opteron™ 6300/6200/6100 series processor supports AMD® HyperTransport™ technology with a system bus of up to 6.4GT/s per link. AMD® Opteron™ 6300/6200/6100 series processor is the one of the most powerful and energy-efficient CPUs in the world.

AMD 4-16 Core Architecture

The motherboard supports AMD 4-16 core processors with discrete L2 cache structure for each core and shared L3 cache to meet demands for more powerful computing.

HyperTransport™ technology 3.0 (HT3)

HyperTransport™ technology 3.0 (HT3) is a high-speed, low latency, point-to-point link designed to improve the overall system balance and scalability with the maximum interconnect rate of 6.4GT/s.

DDR3 memory support

The KGPE-D16 supports UDIMM and RDIMM DDR3 memory that features data transfer rates of 1600/1333/1066/800 MHz to meet the higher bandwidth requirements of server and workstation applications. The 4-channel DDR3 architecture boosts system performance, eliminating bottlenecks. Furthermore, the supply voltage for the memory is reduced from 1.8 V for DDR2 to just 1.5V for DDR3. This voltage reduction limits the power consumption and heat generation of DDR3 which makes it an ideal memory solution.

PCI Express™ interface

The motherboard fully supports PCI Express, the latest I/O interconnect technology that speeds up the PCI bus. PCI Express features point-to-point serial interconnections between devices and allows higher clockspeeds by carrying data in packets. This high speed interface is software compatible with existing PCI specifications.

82574L LAN Solution

The motherboard comes with dual Gigabit LAN controllers and ports which provide a total solution for your networking needs. The onboard Intel 82574L Gigabit LAN controllers use the PCI Express interface and could achieve network throughput close to Gigabit bandwidth.

Serial ATA II technology



The motherboard supports the Serial ATA II 3 Gb/s technology through the Serial ATA interface and Intel ICH10R chipset. The Serial ATA II specification provides twice the bandwidth of the current Serial ATA products with a host of new features, including Native Command Queuing (NCQ), Power Management (PM) Implementation Algorithm, and Hot Swap. Serial ATA allows thinner, more flexible cables with lower pin count and reduced voltage requirements.

USB 2.0 technology

The motherboard implements the Universal Serial Bus (USB) 2.0 specification, dramatically increasing the connection speed from the 12 Mbps bandwidth on USB 1.1 to a fast 480 Mbps on USB 2.0. USB 2.0 is backward compatible with USB 1.1.

Temperature, fan, and voltage monitoring

The CPU temperature is monitored to prevent overheating and damage. The system fan rotations per minute (RPM) is monitored for timely failure detection. The chip monitors the voltage levels to ensure stable supply of current for critical components.

1.4.2 Innovative ASUS features

ASUS Fan Speed technology

The ASUS Fan Speed technology smartly adjusts the fan speeds according to the system loading to ensure quiet, cool, and efficient operation.

PIKE (Proprietary I/O Kit Expansion)



PIKE is an on-demand upgrade kit for users. This ASUS unique feature enables users to choose their preferred I/O solutions. ASUS provides multiple SAS solutions for different segments and purposes and PIKE saves lots of validation efforts and hardware cost for end users. Moreover, the special patent design offers multiple I/O solutions without occupying the Slot 6 in 1U system.

ASUS MIO Audio card

Enjoy high-end sound quality! The ASUS MIO audio card is a discrete 8-channel high definition audio (High Definition Audio previously codenamed Azalia) CODEC enable clearest high quality audio output, jack-sensing feature, retasking functions, and multi-streaming technology that simultaneously send different audio streams to different destinations.

This chapter lists the hardware setup procedures that you have to perform when installing system components. It includes description of the jumpers and connectors on the motherboard.

Hardware information



2.1 Before you proceed

Take note of the following precautions before you install motherboard components or change any motherboard settings.



- Unplug the power cord from the wall socket before touching any component.
- Use a grounded wrist strap or touch a safely grounded object or a metal object, such as the power supply case, before handling components to avoid damaging them due to static electricity.
- Hold components by the edges to avoid touching the ICs on them.
- Whenever you uninstall any component, place it on a grounded antistatic pad or in the bag that came with the component.
- Before you install or remove any component, ensure that the power supply is switched off or the power cord is detached from the power supply. Failure to do so may cause severe damage to the motherboard, peripherals, and/or components.

Onboard LED

1. Standby Power LED

The motherboard comes with a standby power LED. The green LED lights up to indicate that the system is ON, in sleep mode, or in soft-off mode. This is a reminder that you should shut down the system and unplug the power cable before removing or plugging in any motherboard component. The illustration below shows the location of the onboard LED

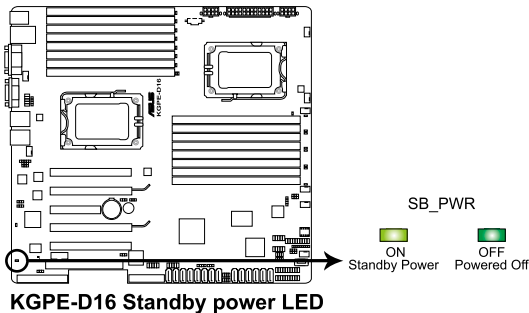

2. CPU warning LED (ERR_CPU1, ERR_CPU2)

The CPU warning LEDs light up to indicate that an impending failure of the corresponding CPU.

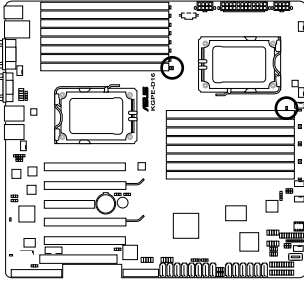

KGPE-D16 ERR CPU LED

3. DIMM warning LED (ERR_DIMMA1/2; ERR_DIMMB1/2; ERR_DIMMC1/2; ERR_DIMMD1/2; ERR_DIMME1/2; ERR_DIMMF1/2; ERR_DIMMG1/2; ERR_DIMMH1/2)

The DIMM warning LEDs light up to indicate that an impending failure of the corresponding DIMMs.

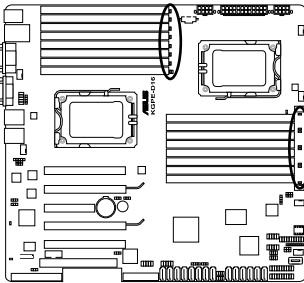

KGPE-D16 ERR DIMM LED

4. **BMC LED (BMC_LED1)**

The green heartbeat LED blinks per second to indicate that the ASMB4 is working normally.

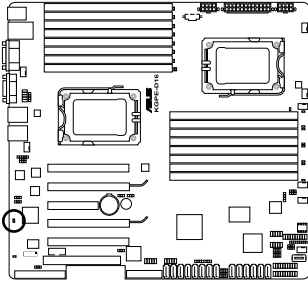

KGPE-D16 BMC LED



The heartbeat LED functions only when you install the ASUS ASMB4.

2.2 Motherboard overview

Before you install the motherboard, study the configuration of your chassis to ensure that the motherboard fits into it.

To optimize the motherboard features, we highly recommend that you install it in an SSI EEB 1.1 compliant chassis.



Ensure to unplug the chassis power cord before installing or removing the motherboard. Failure to do so can cause you physical injury and damage motherboard components!

2.2.1 Placement direction

When installing the motherboard, ensure that you place it into the chassis in the correct orientation. The edge with external ports goes to the rear part of the chassis as indicated in the image below.

2.2.2 Screw holes

Place nine (9) screws into the holes indicated by circles to secure the motherboard to the chassis.



DO NOT overtighten the screws! Doing so can damage the motherboard.

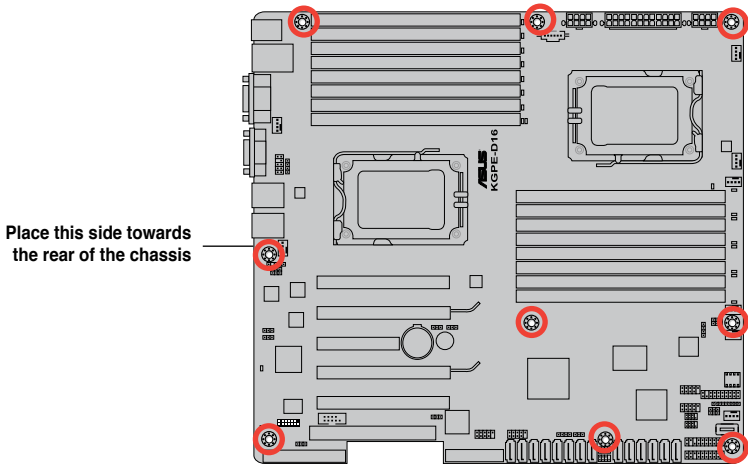

2.2.3 Motherboard layouts

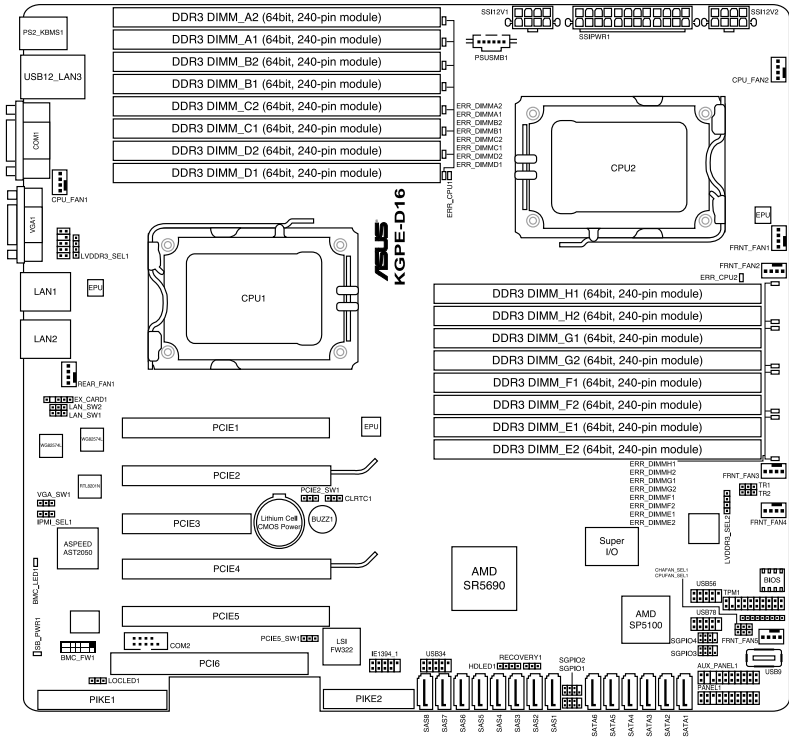

2.2.4 Layout contents

Slots/Socket		Page
1.	CPU sockets	2-10
2.	DDR3 sockets	2-16
3.	MIO / PCIE slot	2-22
4.	PCI Express x 16 slots	2-22
5.	PIKE slot	2-22

Jumpers		Page
1.	Clear RTC RAM (CLRRTC1)	2-26
2.	VGA controller setting (3-pin VGA_SW1))	2-27
3.	CPU Fan and Chassis Fan control setting (3-pin CPUFAN_SEL1, CHAFAN_SEL1)	2-27
4.	LAN controller setting (3-pin LAN_SW1, LAN_SW2)	2-28
5.	DDR3 voltage control setting (4-pin LVDDR3_SEL1; LVDDR3_SEL2)	2-28
6.	PCI Express slot setting (3-pin PCIE2_SW1, PCIE5_SW1)	2-29
7.	IPMI setting (3-pin IPMI_SEL1)	2-29
8.	Force BIOS recovery setting (3-pin RECOVERY1)	2-30

Rear panel connectors		Page
1.	PS/2 mouse port (green)	2-31
2.	RJ-45 port for ASMB4-iKVM	2-31
3.	PS/2 keyboard port (purple)	2-31
4.	USB 2.0 ports 1 and 2	2-31
5.	Serial (COM1) port	2-31
6.	Video Graphics Adapter port	2-31
7.	LAN 1 (RJ-45) port	2-31
8.	LAN 2 (RJ-45) port	2-31

Internal connectors		Page
1.	Serial ATA connectors (7-pin SATA1, SATA2, SATA3, SATA4; RED) (7-pin SATA5, SATA6; Black)	2-32
2.	SAS connectors (7-pin SAS1, SAS2, SAS3, SAS4; Red) (7-pin SAS5, SAS6, SAS7, SAS8; Blue)	2-33
3.	Hard disk activity LED connector (4-pin HDLED1)	2-33
4.	USB connector (10-1 pin USB34, USB56; USB78; A-Type USB9)	2-34
5.	Thermal sensor cable connectors (3-pin TR1, TR2)	2-34
6.	CPU, front and rear fan connectors (4-pin CPU_FAN1, CPU_FAN2, FRNT_FAN1, FRNT_FAN2, FRNT_FAN3, FRNT_FAN4, FRNT_FAN5, REAR_FAN1)	2-35
7.	Serial General Purpose Input/Output connectors (8-1 pin SGPIO1/2)	2-36
8.	Serial General Purpose Input/Output connectors (8-1 pin SGPIO3/4)	2-36
9.	IEEE 1394a port connector (10-1 pin IE1394_2)	2-37
10.	Serial port connector (10-1 pin COM2)	2-37
11.	BMC header (BMC_FW1)	2-38
12.	TPM connector (20-1 pin TPM1)	2-38
13.	Power Supply SMBus connector (5-pin PSUSMB1)	2-39
14.	Location LED cable connector (3-pin LOCLE1)	2-39
15.	SSI power connectors (24-pin SSIPWR1, 8-pin SSI12V1, 8-pin SSI12V2)	2-40
16.	System panel connector (20-1 pin PANEL1)	2-41
17.	Auxiliary panel connector (20-2 pin AUX_PANEL1)	2-42

2.3 Central Processing Unit (CPU)

The motherboard comes with dual surface mount LGA 1944 Socket designed for the AMD® Opteron™ 6300/6200/6100 series CPU in the Land Grid Array (LGA) package.



- Upon purchase of the motherboard, ensure that the PnP cap is on the socket and the socket contacts are not bent. Contact your retailer immediately if the PnP cap is missing, or if you see any damage to the PnP cap/socket contacts/motherboard components. ASUS shoulders the repair cost only if the damage is shipment/transit-related.
- Keep the cap after installing the motherboard. ASUS will process Return Merchandise Authorization (RMA) requests only if the motherboard comes with the cap on the Socket 1944.
- The product warranty does not cover damage to the socket contacts resulting from incorrect CPU installation/removal, or misplacement/loss/incorrect removal of the PnP cap.

2.3.1 Installing the CPU

To install a CPU:

1. Locate the CPU socket on the motherboard.

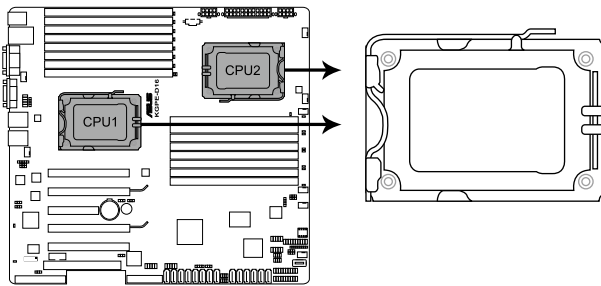

KGPE-D16 CPU LGA1944 Socket



Before installing the CPU, ensure that the socket box is facing toward you and the load lever is on your left.

2. Press the load lever with your thumb (A), then move it to the right (B) until it is released from the retention tab.



To prevent damage to the socket pins, do not remove the PnP cap unless you are installing a CPU.

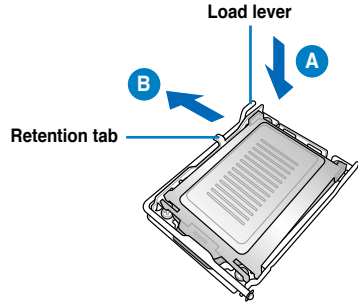

3. Lift the load lever in the direction of the arrow.

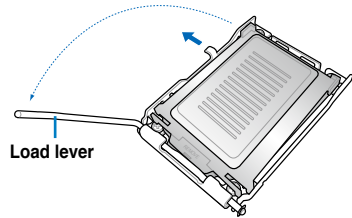

4. Lift the load plate with your thumb and forefinger.

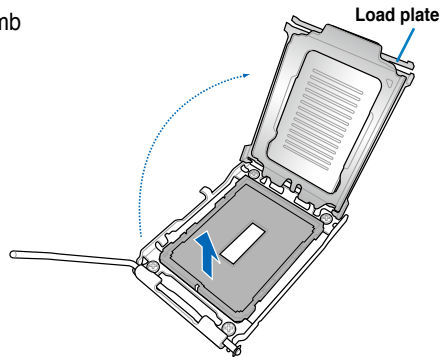

5. Position the CPU over the socket, ensuring that the gold triangle is on the bottom-right corner of the socket, and then fit the socket alignment keys into the CPU notches.

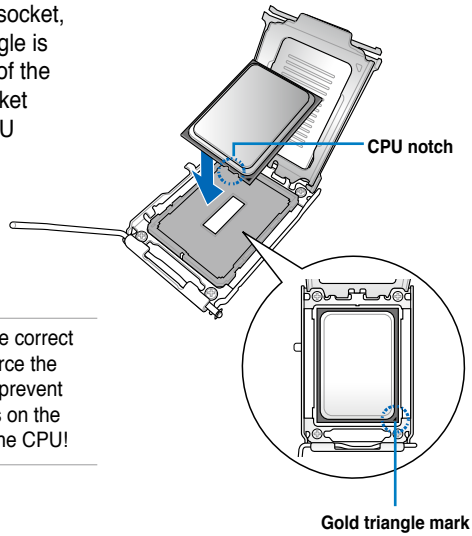

The CPU fits in only one correct orientation. DO NOT force the CPU into the socket to prevent bending the connectors on the socket and damaging the CPU!

6. Close the load plate (A), then push the load lever (B) until it snaps into the retention tab.

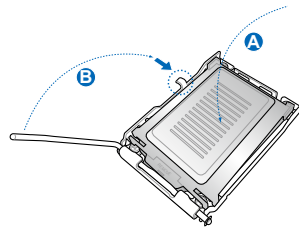

7. Remove the PnP cap from the CPU socket.
8. Apply some Thermal Interface Material to the exposed area of the CPU that the heatsink will be in contact with, ensuring that it is spread in an even thin layer. Some heatsinks come with pre-applied Thermal Interface Material. If so, skip this step.

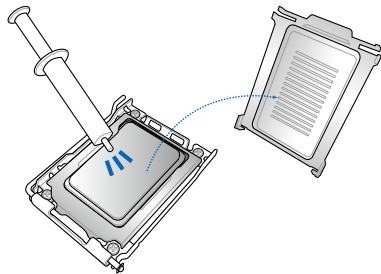

2.3.2 Installing the CPU heatsink and fan

The AMD® Opteron™ 6300/6200/6100 series processors require a specially designed heatsink to ensure optimum thermal condition and performance.



- Ensure to use qualified heatsink assembly only.
- Ensure that you have applied the thermal grease to the top of the CPU before installing the heatsink and fan.

To install the CPU heatsink and fan:

1. Place the heatsink on top of the installed CPU, ensuring that the heatsink fits properly on the retention module base.



- The retention module base is already installed on the motherboard upon purchase.
- You do not have to remove the retention module base when installing the CPU or installing other motherboard components.
- If you purchased a separate CPU heatsink and fan assembly, ensure that a Thermal Interface Material is properly applied to the CPU heatsink or CPU before you install the heatsink and fan assembly.

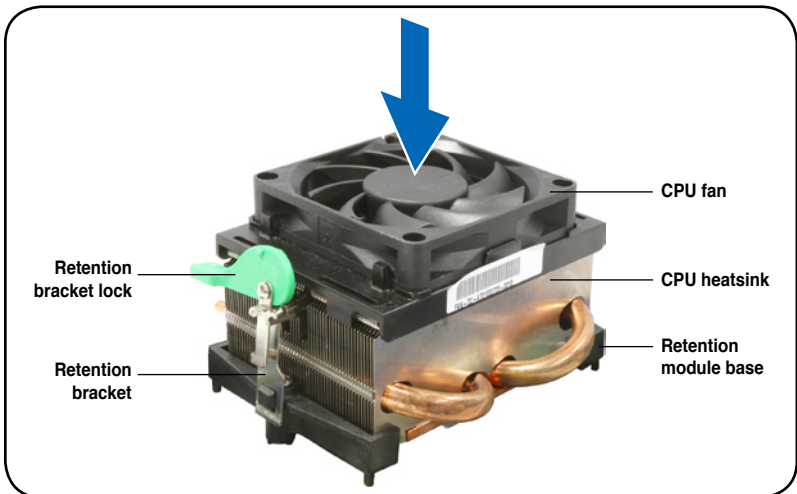

Your boxed CPU heatsink and fan assembly should come with installation instructions for the CPU, heatsink, and the retention mechanism. If the instructions in this section do not match the CPU documentation, follow the latter.

2. Attach one end of the retention bracket to the retention module base.



3. Align the other end of the retention bracket to the retention module base. A clicking sound denotes that the retention bracket is in place.



Ensure that the fan and heatsink assembly perfectly fits the retention mechanism module base, otherwise you cannot snap the retention bracket in place.

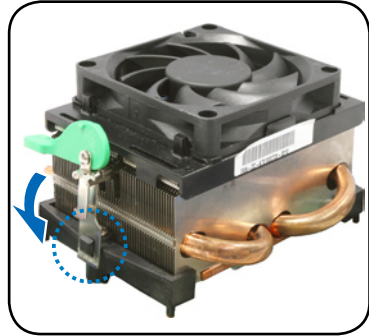

4. Push down the retention bracket lock on the retention mechanism to secure the heatsink and fan to the module base.

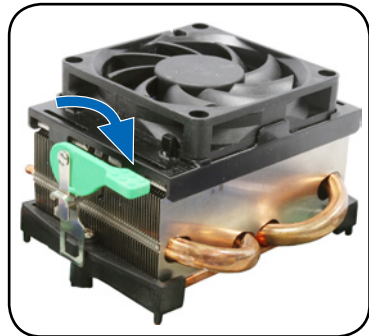

- When the fan and heatsink assembly is in place, connect the CPU fan cable to the connector on the motherboard labeled CPU_FAN.

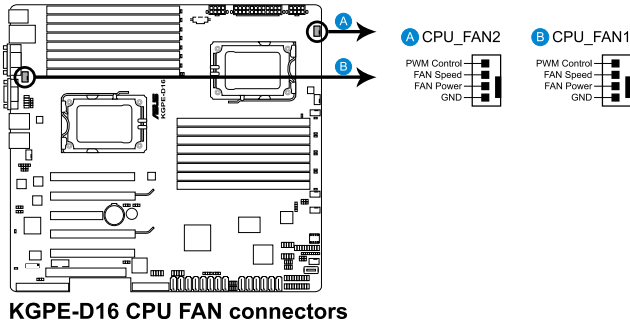

- Do not forget to connect the CPU fan connector! Hardware monitoring errors can occur if you fail to plug this connector.
- This connector is backward compatible with old 3-pin CPU fan.

- Repeat steps 1 to 5 to install the other heatsink if you have installed a second CPU, then connect the fan cable to the other 4-pin connector.

2.4 System memory

2.4.1 Overview

The motherboard comes with sixteen (16) Double Data Rate 3 (DDR3) Dual Inline Memory Modules (DIMM) sockets.

A DDR3 module has the same physical dimensions as a DDR2 DIMM but is notched differently to prevent installation on a DDR2 DIMM socket. DDR3 modules are developed for better performance with less power consumption.

The figure illustrates the location of the DDR3 DIMM sockets:

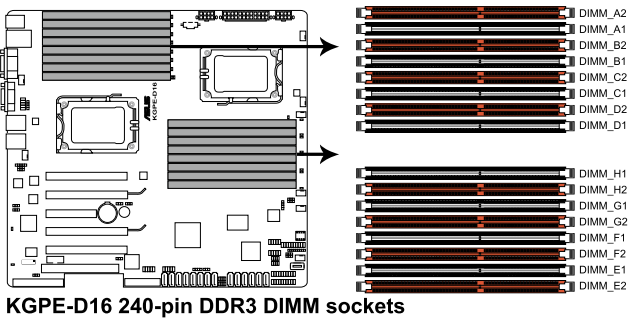

2.4.2 Memory Configurations

You may install 1GB/2GB/4GB/8GB/16GB Registered or 1GB/2GB/4GB Unbuffered with ECC/Non-ECC DDR3 DIMMs into the DIMM sockets using the memory configurations in this section.



-
- Always install DIMMs with the same CAS latency. For optimum compatibility, it is recommended that you obtain memory modules from the same vendor.
 - For CPU1 configuraton, install DIMMs from the orange slots and in the order as follows: DIMM_A2 -> DIMM_C2 -> DIMM_B2 -> DIMM_D2.
For CPU1 + CPU2 configuraton, install DIMMs from the orange slots and in the order as follows: DIMM_A2 -> DIMM_E2 -> DIMM_C2 -> DIMM_G2.
 - **For Quad Ranks DIMMs, when installing less than or equal to four DIMMs:**
For CPU1 configuration, install DIMMs to the orange slots and in the order as follows: DIMM_A2 -> DIMM_C2 -> DIMM_B2 -> DIMM_D2.
For CPU1 + CPU2 configuration, install DIMMs to the orange slots and in the order as follows: DIMM_A2 -> DIMM_E2 -> DIMM_C2 -> DIMM_G2.
 - **For Quad Ranks DIMMs, when installing more than four DIMMs:**
For CPU1 configuration, install DIMMs in the order as follows: DIMM_A2 -> DIMM_C2 -> DIMM_B2 -> DIMM_D2 -> DIMM_A1 -> DIMM_C1 -> DIMM_B1 -> DIMM_D1.
For CPU1 + CPU2 configuration, install DIMMs in the order as follows: DIMM_A2 -> DIMM_E2 -> DIMM_C2 -> DIMM_G2 -> DIMM_B2 -> DIMM_F2 -> DIMM_D2 -> DIMM_H2 --> DIMM_A1 -> DIMM_E1 -> DIMM_C1 -> DIMM_G1 -> DIMM_B1 -> DIMM_F1 -> DIMM_D1 -> DIMM_H1.
-

Memory population table

For UDIMM (Single Rank, Dual Ranks)

CPU1 Configuration																
	A2	A1	B2	B1	C2	C1	D2	D1	-	-	-	-	-	-	-	-
2 DIMMs	V				V											
4 DIMMs	V		V		V		V									
6 DIMMs	V	V	V		V	V	V									
8 DIMMs	V	V	V	V	V	V	V	V								
CPU1 + CPU2 Configuration																
	A2	A1	B2	B1	C2	C1	D2	D1	E2	E1	F2	F1	G2	G1	H2	H1
2 DIMMs	V								V							
4 DIMMs	V				V				V				V			
6 DIMMs	V		V		V				V		V		V			
8 DIMMs	V		V		V		V		V		V		V		V	
10 DIMMs	V	V	V		V		V		V	V	V		V		V	
12 DIMMs	V	V	V		V	V	V		V	V	V		V	V	V	
14 DIMMs	V	V	V	V	V	V	V		V	V	V	V	V	V	V	
16 DIMMs	V	V	V	V	V	V	V	V	V	V	V	V	V	V	V	V

For RDIMM (Single Rank, Dual Ranks & Quad Ranks)

CPU1 Configuration																
	A2	A1	B2	B1	C2	C1	D2	D1	-	-	-	-	-	-	-	-
2 DIMMs	V				V											
4 DIMMs	V		V		V		V									
6 DIMMs	V	V	V		V	V	V									
8 DIMMs	V	V	V	V	V	V	V	V								
CPU1 + CPU2 Configuration																
	A2	A1	B2	B1	C2	C1	D2	D1	E2	E1	F2	F1	G2	G1	H2	H1
2 DIMMs	V								V							
4 DIMMs	V				V				V				V			
6 DIMMs	V		V		V				V		V		V			
8 DIMMs	V		V		V		V		V		V		V		V	
10 DIMMs	V	V	V		V		V		V	V	V		V		V	
12 DIMMs	V	V	V		V	V	V		V	V	V		V	V	V	
14 DIMMs	V	V	V	V	V	V	V		V	V	V	V	V	V	V	
16 DIMMs	V	V	V	V	V	V	V	V	V	V	V	V	V	V	V	V

2.4.3 Installing a DIMM



Unplug the power supply before adding or removing DIMMs or other system components. Failure to do so can cause severe damage to both the motherboard and the components.

To install a DIMM:

1. Press the retaining clips outward to unlock a DIMM socket.
2. Align a DIMM on the socket such that the notch on the DIMM matches the break on the socket.
3. Firmly insert the DIMM into the socket until the retaining clips snap back in place and the DIMM is properly seated.

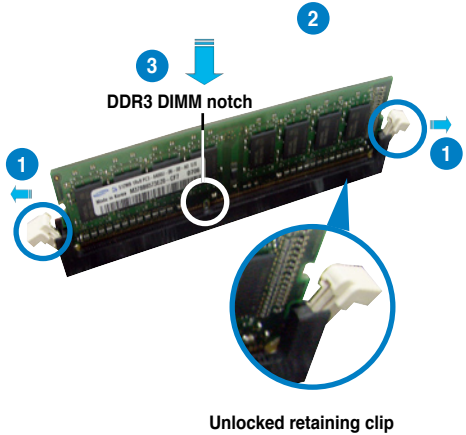

- A DDR3 DIMM is keyed with a notch so that it fits in only one direction. DO NOT force a DIMM into a socket to avoid damaging the DIMM.
- The DDR3 DIMM sockets do not support DDR and DDR2 DIMMs. DO NOT install DDR or DDR2 DIMMs to the DDR3 DIMM sockets.

2.4.4 Removing a DIMM

To remove a DIMM:

1. Simultaneously press the retaining clips outward to unlock the DIMM.



Support the DIMM lightly with your fingers when pressing the retaining clips. The DIMM might get damaged when it flips out with extra force.

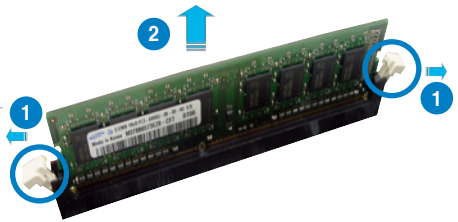

2. Remove the DIMM from the socket.

2.5 Expansion slots

In the future, you may need to install expansion cards. The following subsections describe the slots and the expansion cards that they support.



Ensure to unplug the power cord before adding or removing expansion cards. Failure to do so may cause you physical injury and damage motherboard components.

2.5.1 Installing an expansion card

To install an expansion card:

1. Before installing the expansion card, read the documentation that came with it and make the necessary hardware settings for the card.
2. Remove the system unit cover (if your motherboard is already installed in a chassis).
3. Remove the bracket opposite the slot that you intend to use. Keep the screw for later use.
4. Align the card connector with the slot and press firmly until the card is completely seated on the slot.
5. Secure the card to the chassis with the screw you removed earlier.
6. Replace the system cover.

2.5.2 Configuring an expansion card

After installing the expansion card, configure the it by adjusting the software settings.

1. Turn on the system and change the necessary BIOS settings, if any. See Chapter 4 for information on BIOS setup.
2. Assign an IRQ to the card. Refer to the tables on the next page.
3. Install the software drivers for the expansion card.



When using PCI cards on shared slots, ensure that the drivers support “Share IRQ” or that the cards do not need IRQ assignments. Otherwise, conflicts will arise between the two PCI groups, making the system unstable and the card inoperable.

2.5.3 Interrupt assignments

Standard Interrupt assignments

IRQ	Priority	Standard function
0	1	System Timer
1	2	Keyboard Controller
2	-	Programmable Interrupt
3*	11	Communications Port (COM2)
4*	12	Communications Port (COM1)
5*	13	--
6	14	Floppy Disk Controller
7*	15	--
8	3	System CMOS/Real Time Clock
9*	4	ACPI Mode when used
10*	5	IRQ Holder for PCI Steering
11*	6	IRQ Holder for PCI Steering
12*	7	PS/2 Compatible Mouse Port
13	8	Numeric Data Processor
14*	9	Primary IDE Channel
15*	10	Secondary IDE Channel

* These IRQs are usually available for ISA or PCI devices.

2.5.4 MIO/PCIE slot

The MIO/PCIE slot supports a MIO audio card or a PCI Express card. The MIO audio card offers great sound quality to complement the robust video power.

2.5.5 PCI Express x16 slots (x16 link; x8 link)

The onboard PCI Express x16 slots provides two x16 link or one x16 link and two x8 links to AMD SR5690 chipset. These slots support VGA cards and various server class high performance add-on cards.

2.5.6 PCI slot

The PCI slot supports cards such as a LAN card, SCSI card, USB card, and other cards that comply with PCI specifications.

2.5.7 PIKE slot

The PIKE slot allows you to choose and change your preferred SAS solution easily. Install an optional ASUS PIKE RAID card based on your needs.

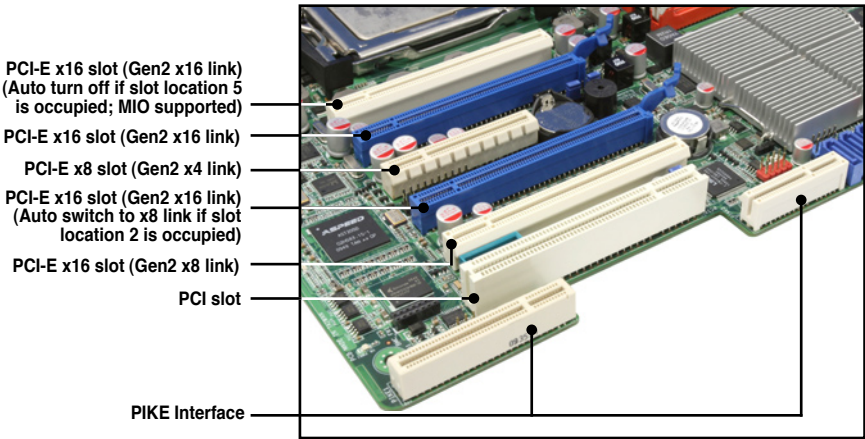

The PIKE Interface is for ASUS PIKE RAID card only.

2.5.8 Installing an ASUS PIKE RAID card

Follow the steps below to install an optional ASUS RAID card on your motherboard.

1. Locate the PIKE RAID card slot on the motherboard.

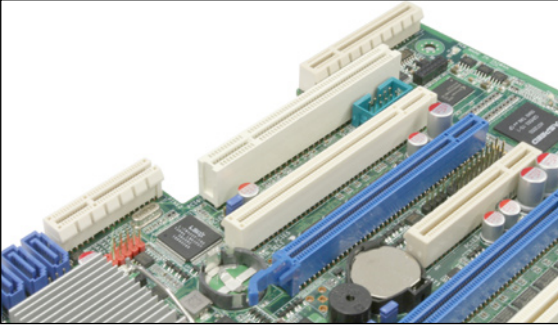

2. Align the golden fingers of the RAID card with the PIKE RAID card slot.

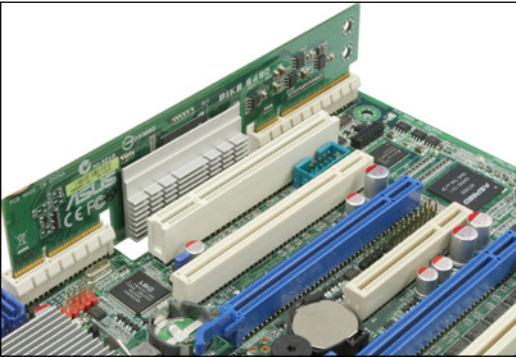

3. Insert the RAID card into the PIKE RAID card slot. Ensure that it is completely seated on the PIKE RAID card slot.

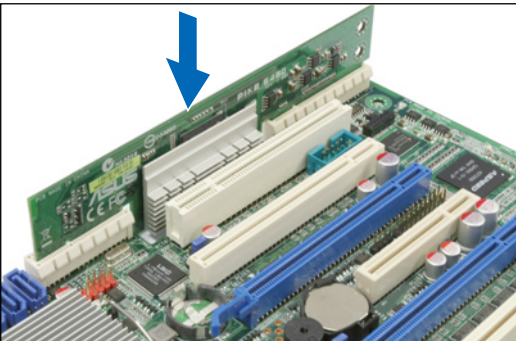

2.5.9 Installing ASMB4 management board

Follow the steps below to install an optional ASMB4 management board on your motherboard.

1. Locate the BMC_FW header on the motherboard.

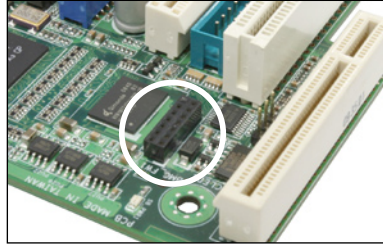

2. Orient and press the ASMB4 management card in place.

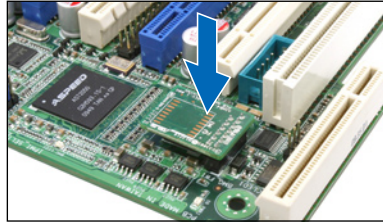

2.5.10 Connecting the thermal sensor cable

Follow the steps below to connect the thermal sensor cable to the connector on your motherboard.

1. Locate the TR1 or TR2 connector on the motherboard.

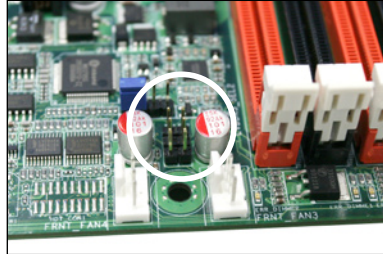

2. Connect the thermal sensor cable to the connector.

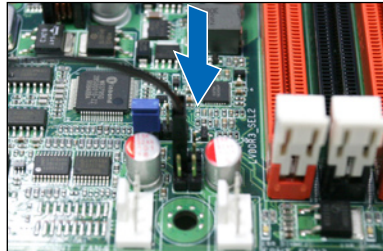

3. Place the other end of the thermal sensor cable to the device you would like to monitor temperature.

2.5.11 Installing the audio card

1. Locate the MIO/PCIE slot on the motherboard.

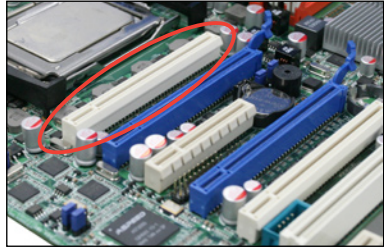

2. Align the card connector with the slot and press firmly until the card sits on the slot completely.

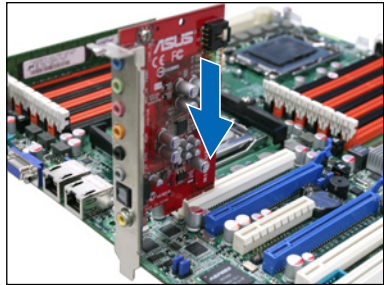

2.6 Jumpers

1. Clear RTC RAM (CLRTC1)

This jumper allows you to clear the Real Time Clock (RTC) RAM in CMOS. You can clear the CMOS memory of date, time, and system setup parameters by erasing the CMOS RTC RAM data. The onboard button cell battery powers the RAM data in CMOS, which include system setup information such as system passwords.

To erase the RTC RAM:

1. Turn OFF the computer and unplug the power cord.
2. Move the jumper cap from pins 1–2 (default) to pins 2–3. Keep the cap on pins 2–3 for about 5–10 seconds, then move the cap back to pins 1–2.
3. Plug the power cord and turn ON the computer.
4. Hold down the key during the boot process and enter BIOS setup to re-enter data.



Except when clearing the RTC RAM, never remove the cap on CLRTC1 jumper default position. Removing the cap will cause system boot failure!



If the steps above do not help, remove the onboard battery and move the jumper again to clear the CMOS RTC RAM data. After the CMOS clearance, reinstall the battery.

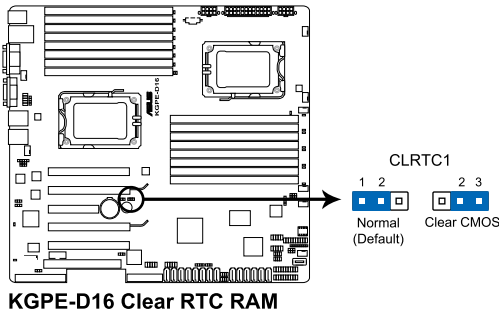

2. VGA controller setting (3-pin VGA_SW1)

This jumper allows you to enable or disable the onboard VGA controller. Set to pins 1–2 to activate the VGA feature.

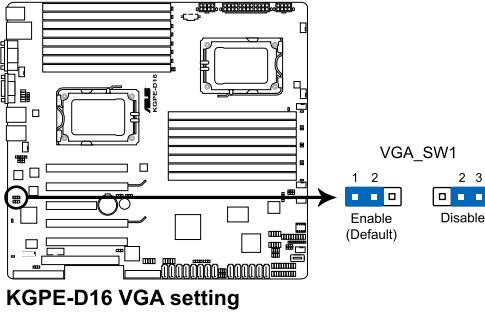

3. CPU Fan and Chassis Fan control setting (3-pin CPUFAN_SEL1, CHAFAN_SEL1)

These jumpers allow you to switch for fan pin selection. The CPUFAN_SEL1 jumper is for the CPU fans control and the CHAFAN_SEL1 jumper is for the front fans and rear fans control. Set to pins 1–2 when using 4-pin fans or pins 2–3 when using 3-pin fans.

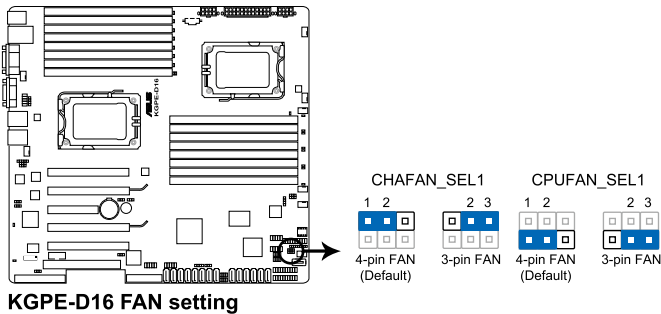

- If you use a 4-pin fan but set the jumper to pin 2-3, the fan you installed may not work.
- If you use a 3-pin fan but set the jumper for a 4-pin fan, the fan control will not work and the fan you installed will always run at full speed.

4. LAN controller setting (3-pin LAN_SW1, LAN_SW2)

These jumpers allow you to enable or disable the onboard Intel® 82574L Gigabit LAN controllers. Set to pins 1-2 to activate the Gigabit LAN feature.

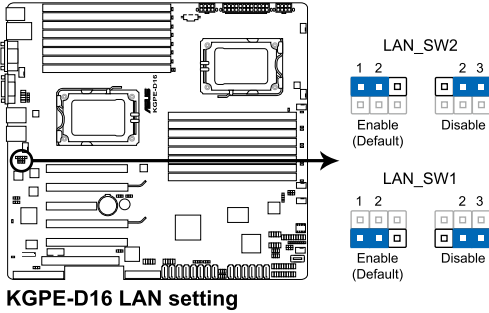

5. DDR3 voltage control setting (4-pin LVDDR3_SEL1; LVDDR3_SEL2)

These jumpers allow you to adjust the DIMM voltage. Set to pins 1–2 to select 1.5V BIOS control, pins 2–3 to select 1.2V Force or 3–4 to select 1.35V Force.

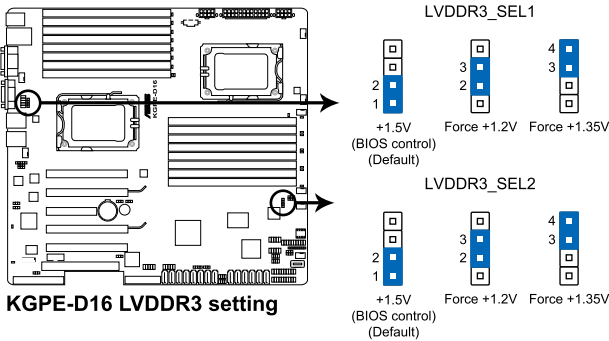

6. PCI Express slot setting (3-pin PCIE2_SW1; PCIE5_SW1)

These jumpers allow you to turn off slot 1 or 4 no matter slot 2 or 5 is occupied or not. Place the jumper caps on pins 1–2 to let the system detect if the slot 2 or slot 5 is occupied, and turn off slot 1 or 4 automatically (default). Or you can place the jumper caps on pins 2–3 to turn off slot 1 or 4.

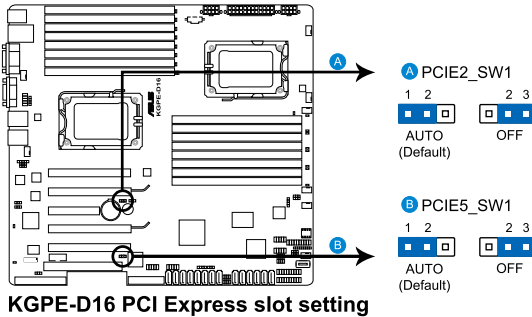

7. IPMI setting (3-pin IPMI_SEL1)

This jumper allows you to use the IPMI feature through the dedicated LAN or share LAN. Place the jumper caps on pins 1–2 if you want to use IPMI through the dedicated LAN (default). Or you can place the jumper caps on pins 2–3 to use IPMI through the shared LAN.

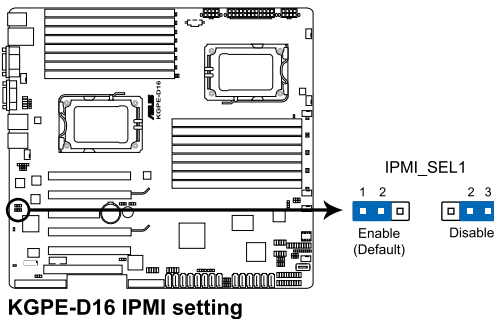

8. Force BIOS recovery setting (3-pin RECOVERY1)

This jumper allows you to quickly update or recover the BIOS settings when it becomes corrupted.

To update the BIOS:

1. Set the jumper to pins 2–3.
2. Insert the USB flash that contains the original or latest BIOS and turn on the system to recover or update the BIOS.
3. Shut down the system.
4. Set the jumper back to pins 1–2.
5. Turn on the system.

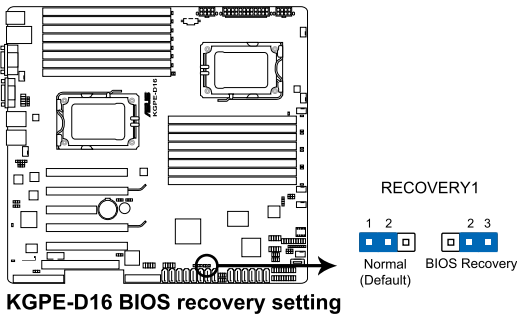

2.7 Connectors

2.7.1 Rear panel connectors

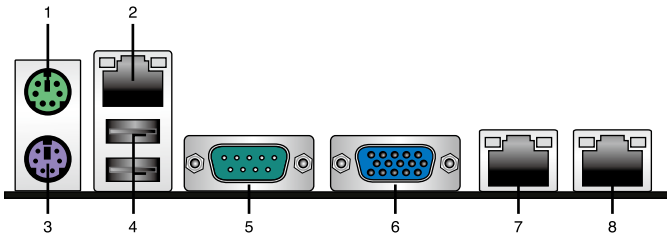

1. **PS/2 mouse port (green).** This port is for a PS/2 mouse.
2. **RJ-45 port for iKVM.** This RJ-45 port functions only when you install ASMB4 management card.
3. **PS/2 keyboard port (purple).** This port is for a PS/2 keyboard.
4. **USB 2.0 ports 1 and 2.** These two 4-pin Universal Serial Bus (USB) ports are available for connecting USB 2.0 devices.
5. **Serial (COM1) port.** This 9-pin communication port is for pointing devices or other serial devices.
6. **Video Graphics Adapter port.** This port is for a VGA monitor or other VGA-compatible devices.
7. **LAN 1 (RJ-45) port.** This port allows Gigabit connection to a Local Area Network (LAN) through a network hub. Refer to the table below for the LAN port LED indications.
8. **LAN 2 (RJ-45) port.** This port allows Gigabit connection to a Local Area Network (LAN) through a network hub. Refer to the table below for the LAN port LED indications.

LAN port LED indications

Activity/Link LED		Speed LED	
Status	Description	Status	Description
OFF	No link	OFF	10 Mbps connection
GREEN	Linked	ORANGE	100 Mbps connection
BLINKING	Data activity	GREEN	1 Gbps connection

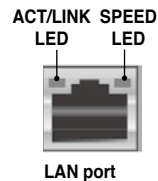

2. SAS connectors (7-pin SAS1, SAS2, SAS3, SAS4; Red) (7-pin SAS5, SAS6, SAS7, SAS8; Blue)

This motherboard comes with eight (8) Serial Attached SCSI (SAS) connectors, the next-generation storage technology that supports both Serial Attached SCSI (SAS) and Serial ATA (SATA). Each connector supports one device.



- These connectors function only when you install a PIKE RAID card.
- Connect the SAS hard disk drives to SAS connectors 1–4 (red) when installing a 4-port PIKE RAID card.

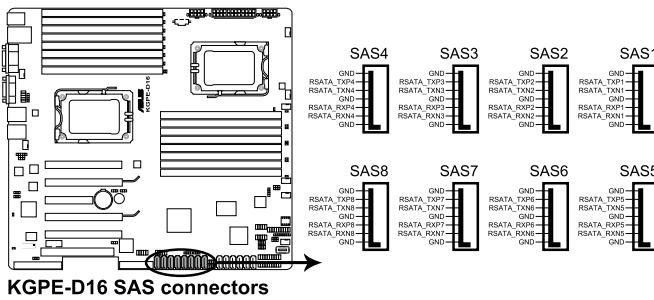

3. Hard disk activity LED connector (4-pin HDLED1)

This LED connector is for the storage add-on card cable connected to the SATA or SAS add-on card. The read or write activities of any device connected to the SATA or SAS add-on card causes the front panel LED to light up.

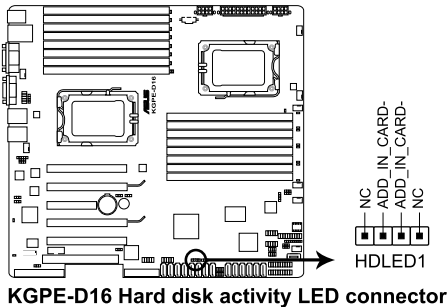

4. USB connector (10-1 pin USB34, USB56; USB78; A-Type USB9)

These connectors are for USB 2.0 ports. Connect the USB module cables to connectors USB34 and USB56, then install the modules to a slot opening at the back of the system chassis. These USB connectors comply with USB 2.0 specification that supports up to 480 Mbps connection speed.

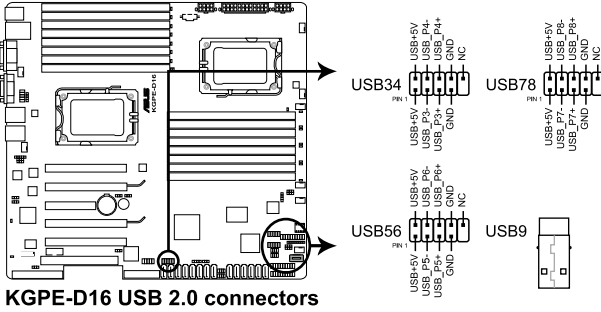

5. Thermal sensor cable connectors (3-pin TR1, TR2)

These connectors are for temperature monitoring. Connect the thermal sensor cables to these connectors and place the other ends to the devices, which you want to monitor temperature.

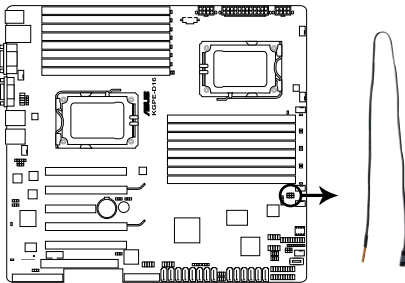

6. CPU, front and rear fan connectors
(4-pin CPU_FAN1, CPU_FAN2, FRNT_FAN1, FRNT_FAN2, FRNT_FAN3,
FRNT_FAN4, FRNT_FAN5, REAR_FAN1)

The fan connectors support cooling fans of 350 mA–740 mA (8.88 W max.) or a total of 3.15 A–6.66 A (53.28 W max.) at +12V. Connect the fan cables to the fan connectors on the motherboard, ensuring that the black wire of each cable matches the ground pin of the connector.



- DO NOT forget to connect the fan cables to the fan connectors. Insufficient air flow inside the system may damage the motherboard components.
- These are not jumpers! DO NOT place jumper caps on the fan connectors!
- All fans feature the ASUS Fan Speed technology.

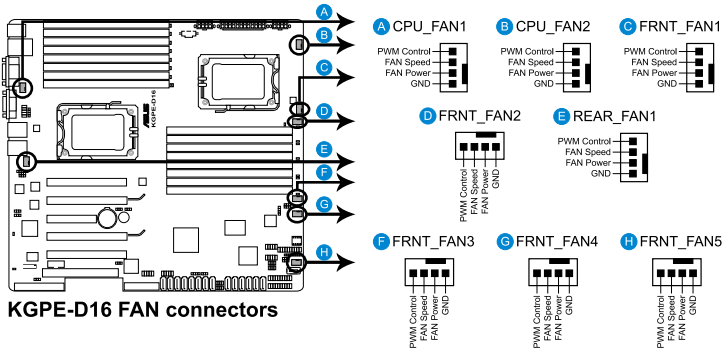

7. Serial General Purpose Input/Output connectors (8-1 pin SGPIO1/2)

These connector is used for the SAS chip SGPIO interface that controls the LED pattern generation, device information and general purpose data.

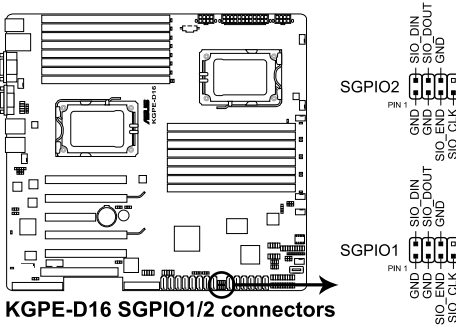

These connectors functions only when you install an ASUS PIKE SAS RAID card.

8. Serial General Purpose Input/Output connectors (8-1 pin SGPIO3/4)

These connectors are used for the SGPIO peripherals of the PROMISE® RAID SATA LED.

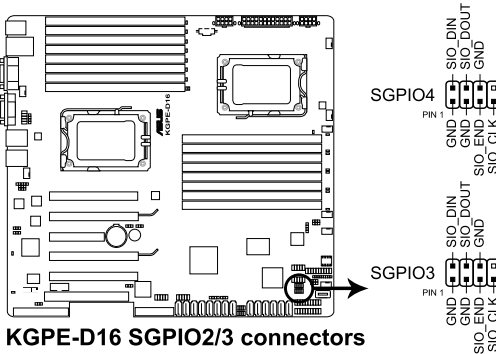

9. IEEE 1394a port connector (10-1 pin IE1394_2)

This connector is for an IEEE 1394a port. Connect the IEEE 1394a module cable to this connector, then install the module to a slot opening at the back of the system chassis.

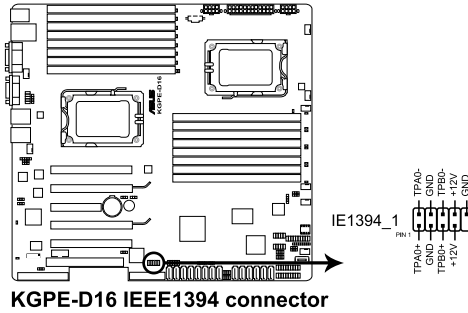

10. Serial port connector (10-1 pin COM2)

This connector is for a serial (COM) port. Connect the serial port module cable to this connector, then install the module to a slot opening at the back of the system chassis.

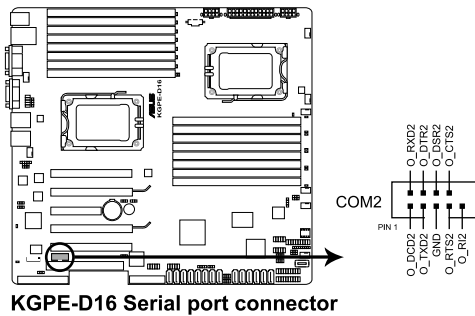

11. BMC header (BMC_FW1)

The BMC connector on the motherboard supports an ASUS® Server Management Board 4 Series (ASMB4).

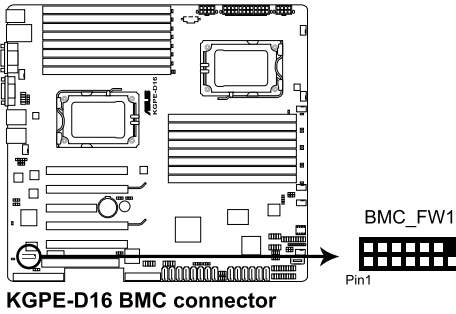

12. TPM connector (20-1 pin TPM)

This connector supports a Trusted Platform Module (TPM) system, which can securely store keys, digital certificates, passwords, and data. A TPM system also helps enhance network security, protects digital identities, and ensures platform integrity.

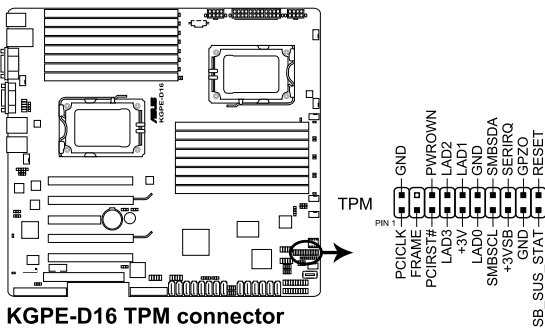

13. Location LED cable connector (3-pin LOCLED1)

This connector is for a LED cable that allows you to know the server location.

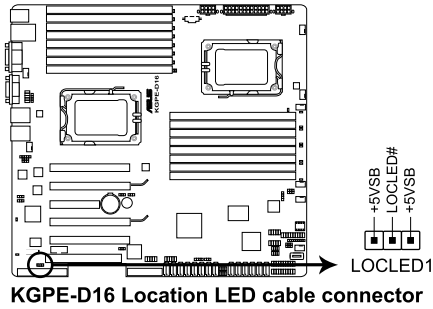

14. Power Supply SMBus connector (5-pin PSUSMB1)

This connector allows you to connect SMBus (System Management Bus) to the power supply unit to read PSU information. Devices communicate with an SMBus host and/or other SMBus devices using the SMBus interface.

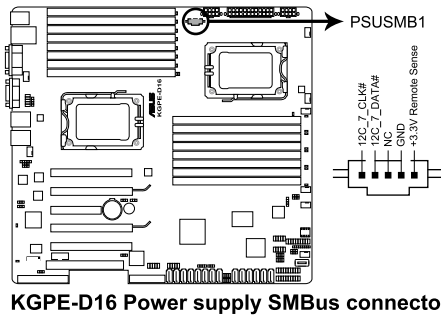

This connector functions only when you install the ASUS ASMB4.

15. SSI power connectors (24-pin SSIPWR1, 8-pin SSI12V1, 8-pin SSI12V2)

These connectors are for an SSI power supply plugs. The power supply plugs are designed to fit these connectors in only one orientation. Find the proper orientation and push down firmly until the connectors completely fit.



- DO NOT forget to connect the 24+8+8-pin power plugs; otherwise, the system will not boot up.
- Use of a PSU with a higher power output is recommended when configuring a system with more power-consuming devices. The system may become unstable or may not boot up if the power is inadequate.
- Ensure that your power supply unit (PSU) can provide at least the minimum power required by your system.

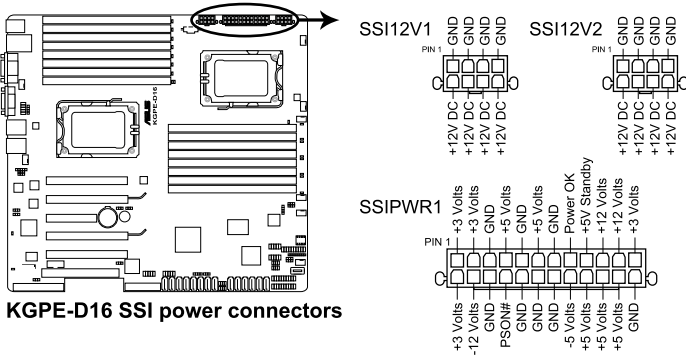

17. Auxiliary panel connector (20-pin AUX_PANEL1)

This connector is for additional front panel features including front panel SMB, locator LED and switch, chassis intrusion, and LAN LEDs.

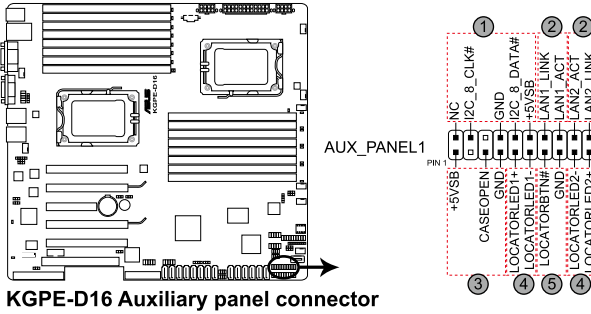

KGPE-D16 Auxiliary panel connector

- 1. Front panel SMB (6-1 pin FPSMB)**
These leads connect the front panel SMBus cable.
- 2. LAN activity LED (2-pin LAN1_LED, LAN2_LED)**
These leads are for Gigabit LAN activity LEDs on the front panel.
- 3. Chassis intrusion (4-1 pin CHASSIS)**
These leads are for the intrusion detection feature for chassis with intrusion sensor or microswitch. When you remove any chassis component, the sensor triggers and sends a high-level signal to these leads to record a chassis intrusion event. The default setting is short CASEOPEN and GND pin by jumper cap to disable the function.
- 4. Locator LED (2-pin LOCATORLED1 and 2-pin LOCATORLED2)**
These leads are for the locator LED1 and LED2 on the front panel. Connect the Locator LED cables to these 2-pin connector. The LEDs will light up when the Locator button is pressed.
- 5. Locator Button/Switch (2-pin LOCATORBTN)**
These leads are for the locator button on the front panel. This button queries the state of the system locator.

This chapter describes the power up sequence, and ways of shutting down the system.

Powering up **3**

Chapter summary

3

3.1	Starting up for the first time.....	3-3
3.2	Powering off the computer.....	3-4

3.1 Starting up for the first time

1. After making all the connections, replace the system case cover.
2. Be sure that all switches are off.
3. Connect the power cord to the power connector at the back of the system chassis.
4. Connect the power cord to a power outlet that is equipped with a surge protector.
5. Turn on the devices in the following order:
 - a. Monitor
 - b. External storage devices (starting with the last device on the chain)
 - c. System power
6. After applying power, the system power LED on the system front panel case lights up. For systems with ATX power supplies, the system LED lights up when you press the ATX power button. If your monitor complies with “green” standards or if it has a “power standby” feature, the monitor LED may light up or switch between orange and green after the system LED turns on.

The system then runs the power-on self-test or POST. While the tests are running, the BIOS beeps or additional messages appear on the screen. If you do not see anything within 30 seconds from the time you turned on the power, the system may have failed a power-on test. Check the jumper settings and connections or call your retailer for assistance.
7. At power on, hold down the key to enter the BIOS Setup. Follow the instructions in Chapter 4.

3.2 Powering off the computer

3.2.1 Using the OS shut down function

If you are using Windows® 2003 Server:

1. Click the **Start** button then click **Shut Down**.
2. Select **Shut Down** from the **What do you want the computer to do?** list box.
3. Select **Shutdown Event Tracker**.
4. Make sure that the **Planned** check box is checked.
5. Select shutdown option from the list box.
6. If necessary, key in comments.
7. Click **OK**.

3.2.2 Using the dual function power switch

While the system is ON, pressing the power switch for less than four seconds puts the system to sleep mode or to soft-off mode, depending on the BIOS setting. Pressing the power switch for more than four seconds lets the system enter the soft-off mode regardless of the BIOS setting. Refer to section **4.6 Power Menu** in Chapter 4 for details.

4.1	Managing and updating your BIOS	4-3
4.2	BIOS setup program	4-7
4.3	Main menu	4-10
4.4	Advanced menu	4-15
4.5	Server menu	4-30
4.6	Power menu.....	4-32
4.7	Boot menu	4-36
4.8	Tools menu	4-40
4.9	Exit menu	4-41

4.1 Managing and updating your BIOS

The following utilities allow you to manage and update the motherboard Basic Input/Output System (BIOS) setup:

1. **ASUS EZ Flash 2** (Updates the BIOS using a USB flash disk.)
2. **BUPDATER utility** (Updates the BIOS in DOS mode using a bootable USB flash disk drive.)
3. **ASUS CrashFree BIOS 3** (To recover the BIOS using a bootable USB flash disk drive when the BIOS file fails or gets corrupted.)

Refer to the corresponding sections for details on these utilities.



Save a copy of the original motherboard BIOS file to a bootable USB flash disk drive in case you need to restore the BIOS in the future. Copy the original motherboard BIOS using the ASUS Update or AFUDOS utilities.

4.1.1 ASUS EZ Flash 2 utility

The ASUS EZ Flash 2 feature allows you to update the BIOS without having to use a DOS-based utility.



Before you start using this utility, download the latest BIOS from the ASUS website at www.asus.com.

To update the BIOS using EZ Flash 2

1. Insert the USB flash disk that contains the latest BIOS file to the USB port.
2. Enter the BIOS setup program. Go to the **Tools** menu to select **EZ Flash 2** and press <Enter> to enable it.
Or, press <Alt> + <F2> during the POST to enable EZ Flash 2.

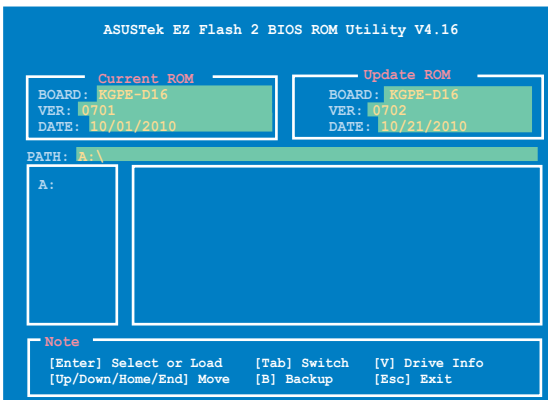

3. Press <Tab> to switch between drives until the correct BIOS file is found. When found, EZ Flash 2 performs the BIOS update process and automatically reboots the system when done.



- This function can support devices such as a USB flash disk with FAT 32/16 format and single partition only.
- DO NOT shut down or reset the system while updating the BIOS to prevent system boot failure!



Ensure to load the BIOS default settings to ensure system compatibility and stability. Select the **Load Setup Defaults** item under the **Exit** menu. See section **4.9 Exit Menu** for details.

4.1.2 BUPDATER utility



The succeeding BIOS screens are for reference only. The actual BIOS screen displays may not be the same as shown.

The BUPDATER utility allows you to update the BIOS file in DOS environment using a bootable USB flash disk drive with the updated BIOS file.

Updating the BIOS file

To update the BIOS file using the BUPDATER utility:

1. Visit the ASUS website at www.asus.com and download the latest BIOS file for the motherboard. Save the BIOS file to a bootable USB flash disk drive.
2. Copy the BUPDATER utility (BUPDATER.exe) from the ASUS support website at support.asus.com to the bootable USB flash disk drive you created earlier.
3. Boot the system in DOS mode, then at the prompt, type:

```
BUPDATER /i [filename] .ROM
```

where [filename] is the latest or the original BIOS file on the bootable USB flash disk drive, then press <Enter>.

```
A:\>BUPDATER /i[file name].ROM
```

- The utility verifies the file, then starts updating the BIOS file.

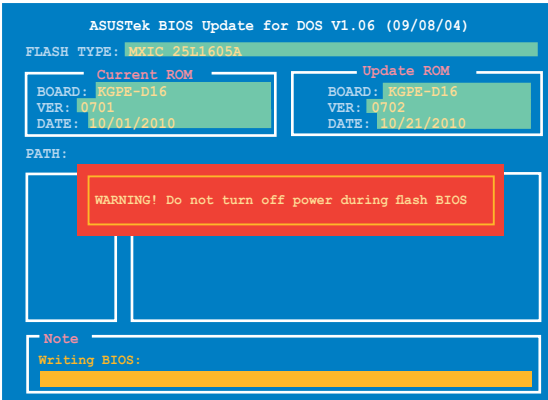

DO NOT shut down or reset the system while updating the BIOS to prevent system boot failure!

- The utility returns to the DOS prompt after the BIOS update process is completed. Reboot the system from the hard disk drive.



4.1.3 ASUS CrashFree BIOS 3 utility

The ASUS CrashFree BIOS 3 is an auto recovery tool that allows you to restore the BIOS file when it fails or gets corrupted during the updating process. You can update a corrupted BIOS file using a USB flash drive that contains the updated BIOS file.



Prepare a USB flash drive containing the updated motherboard BIOS before using this utility.

Recovering the BIOS from a USB flash drive

To recover the BIOS from a USB flash drive:

1. Insert the USB flash drive with the original or updated BIOS file to one USB port on the system.
2. The utility will automatically recover the BIOS. It resets the system when the BIOS recovery finished.



DO NOT shut down or reset the system while recovering the BIOS! Doing so would cause system boot failure!



The recovered BIOS may not be the latest BIOS version for this motherboard. Visit the ASUS website at www.asus.com to download the latest BIOS file.

4.2 BIOS setup program

This motherboard supports a programmable firmware chip that you can update using the provided utility described in section **4.1 Managing and updating your BIOS**.

Use the BIOS Setup program when you are installing a motherboard, reconfiguring your system, or prompted to “Run Setup.” This section explains how to configure your system using this utility.

Even if you are not prompted to use the Setup program, you can change the configuration of your computer in the future. For example, you can enable the security password feature or change the power management settings. This requires you to reconfigure your system using the BIOS Setup program so that the computer can recognize these changes and record them in the CMOS RAM of the firmware chip.

The firmware chip on the motherboard stores the Setup utility. When you start up the computer, the system provides you with the opportunity to run this program. Press during the Power-On Self-Test (POST) to enter the Setup utility; otherwise, POST continues with its test routines.

If you wish to enter Setup after POST, restart the system by pressing <Ctrl+Alt+Delete>, or by pressing the reset button on the system chassis. You can also restart by turning the system off and then back on. Do this last option only if the first two failed.

The Setup program is designed to make it as easy to use as possible. Being a menu-driven program, it lets you scroll through the various submenus and make your selections from the available options using the navigation keys.



- The default BIOS settings for this motherboard apply for most conditions to ensure optimum performance. If the system becomes unstable after changing any BIOS settings, load the default settings to ensure system compatibility and stability. Select the **Load Setup Defaults** item under the Exit Menu. See section **4.9 Exit Menu**.
- The BIOS setup screens shown in this section are for reference purposes only, and may not exactly match what you see on your screen.
- Visit the ASUS website (www.asus.com) to download the latest BIOS file for this motherboard.

4.2.1 BIOS menu screen

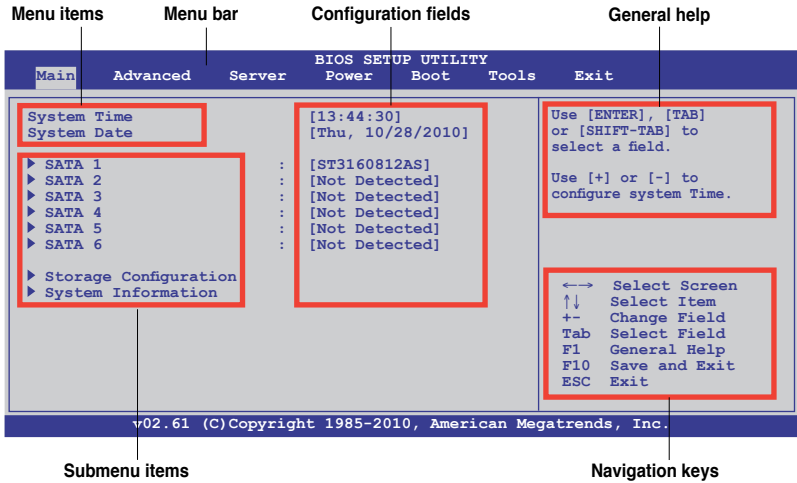

4.2.2 Menu bar

The menu bar on top of the screen has the following main items:

- Main** For changing the basic system configuration
- Advanced** For changing the advanced system settings
- Server** For changing the advanced server settings
- Power** For changing the advanced power management (APM) configuration
- Boot** For changing the system boot configuration
- Tools** For configuring options for special functions
- Exit** For selecting the exit options and loading default settings

To select an item on the menu bar, press the right or left arrow key on the keyboard until the desired item is highlighted.

4.2.3 Navigation keys

At the bottom right corner of a menu screen are the navigation keys for that particular menu. Use the navigation keys to select items in the menu and change the settings.



The navigation keys differ from one screen to another.

4.2.4 Menu items

The highlighted item on the menu bar displays the specific items for that menu. For example, selecting Main shows the Main menu items.

The other items (Advanced, Power, Boot, and Exit) on the menu bar have their respective menu items.

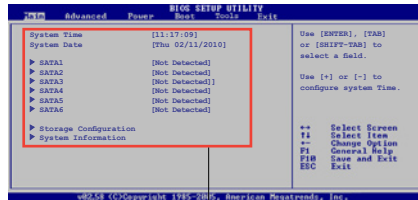

Main menu items

4.2.5 Submenu items

A solid triangle before each item on any menu screen means that the item has a submenu. To display the submenu, select the item and press <Enter>.

4.2.6 Configuration fields

These fields show the values for the menu items. If an item is user-configurable, you can change the value of the field opposite the item. You cannot select an item that is not user-configurable.

A configurable field is enclosed in brackets, and is highlighted when selected. To change the value of a field, select it then press <Enter> to display a list of options. Refer to 4.2.7 Pop-up window.

4.2.7 Pop-up window

Select a menu item then press <Enter> to display a pop-up window with the configuration options for that item.

4.2.8 Scroll bar

A scroll bar appears on the right side of a menu screen when there are items that do not fit on the screen. Press the Up/Down arrow keys or <Page Up> /<Page Down> keys to display the other items on the screen.

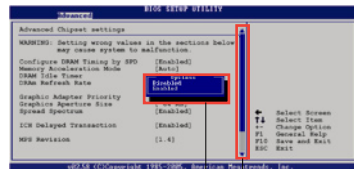

Pop-up window

Scroll bar

4.2.9 General help

At the top right corner of the menu screen is a brief description of the selected item.

4.3.3 SATA1–6

The items in this menu allow you to set or change the configurations for the SATA devices installed in the system. Select an item then press <Enter> if you wish to configure the item.

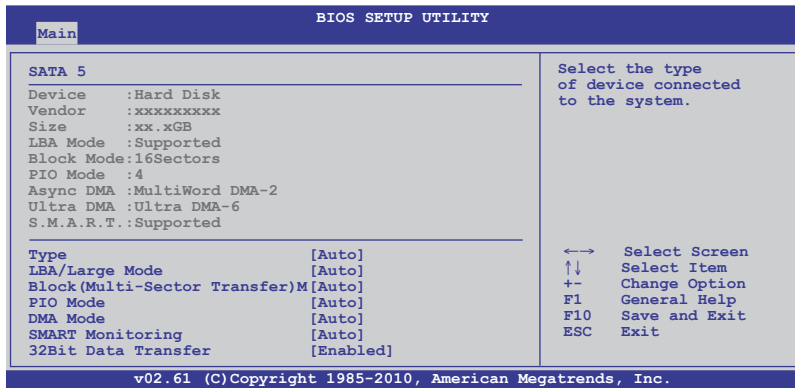

The BIOS automatically detects the values opposite the dimmed items (Device, Vendor, Size, LBA Mode, Block Mode, PIO Mode, Async DMA, Ultra DMA, and S.M.A.R.T. monitoring). These values are not user-configurable. These items show **Not Detected** if no SATA device is installed in the system.

Type [Auto]

Selects the type of SATA drive. Setting to [Auto] allows automatic selection of the appropriate SATA device type. Select [CDROM] if you are specifically configuring a CD-ROM drive. Select [ARMD] (ATAPI Removable Media Device) if your device is either a ZIP, LS-120, or MO drive.

Configuration options: [Not Installed] [Auto] [CDROM] [ARMD]



This item appears in SATA 5/6 only.

LBA/Large Mode [Auto]

Enables or disables the LBA mode. Setting to [Auto] enables the LBA mode if the device supports this mode, and if the device was not previously formatted with LBA mode disabled. Configuration options: [Disabled] [Auto]

Block (Multi-Sector Transfer) M [Auto]

Enables or disables data multi-sectors transfers. When set to [Auto], the data transfer from and to the device occurs multiple sectors at a time if the device supports multi-sector transfer feature. When set to [Disabled], the data transfer from and to the device occurs one sector at a time.

Configuration options: [Disabled] [Auto]

PIO Mode [Auto]

Allows you to select the data transfer mode.
Configuration options: [Auto] [0] [1] [2] [3] [4]

DMA Mode [Auto]

DMA (Direct Memory Access) allows your computer to transfer data to and from the hardware devices installed with much less CPU overhead.

The DMA mode consists of SDMA (single-word DMA), MDMA (multi-word DMA), and UDMA (Ultra DMA). Setting to [Auto] allows automatic selection of the DMA mode.

SMART Monitoring [Auto]

Sets the Smart Monitoring, Analysis, and Reporting Technology.
Configuration options: [Auto] [Disabled] [Enabled]

32Bit Data Transfer [Enabled]

Enables or disables 32-bit data transfer.
Configuration options: [Disabled] [Enabled]

4.3.4 Storage Configuration

The items in this menu allow you to set or change the configurations for the SATA devices installed in the system. Select an item then press <Enter> if you wish to configure the item.

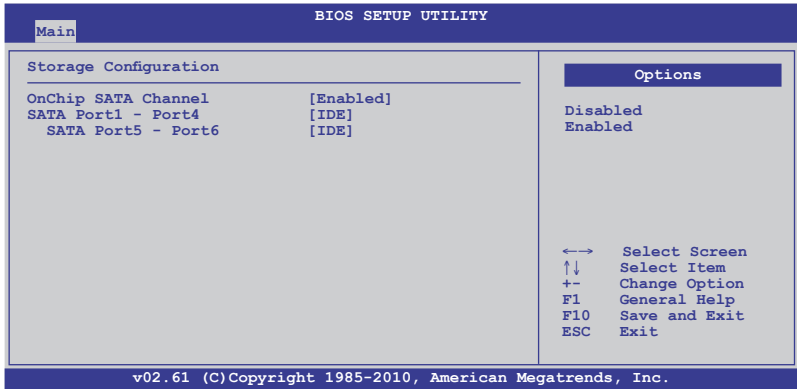

OnChip SATA Channel [Enabled]

Allows you to enable or disable the onboard SATA channel.
Configuration options: [Disabled] [Enabled]



The following two items appear only when you set the **OnChip SATA Channel** item to [Enabled].

SATA Port1 - Port4 [IDE]

Sets the configuration for the Serial ATA connectors supported by the Southbridge chip. Configuration options: [IDE] [RAID] [AHCI]



- If you want to use the Serial ATA hard disk drives as Parallel ATA physical storage devices, keep the default setting [IDE].
- If you want to create RAID sets with the PROMISE® RAID utility from the Serial ATA hard disk drives, set this item to [RAID].
- If you want the Serial ATA hard disk drives to use the Advanced Host Controller Interface (AHCI), set this item to [AHCI]. The AHCI allows the onboard storage driver to enable advanced Serial ATA features that increases storage performance on random workloads by allowing the drive to internally optimize the order of commands.
- When this item is set [AHCI], the information of the SATA connectors 1–6 can be seen only under the OS environment or during POST.

SATA Port5 - Port6 [IDE]

Setting this item to [IDE] instead of [RAID] or [AHCI] allows the system to recognize the optical drives connected to the SATA connectors 5 or 6 when installing OS.



If you use a SATA optical drive to run the OS installation disk, we strongly recommend that you install the optical drive to the SATA connectors 5/6 and set them to [IDE] mode.

4.3.5 System Information

This menu gives you an overview of the general system specifications. The BIOS automatically detects the items in this menu.

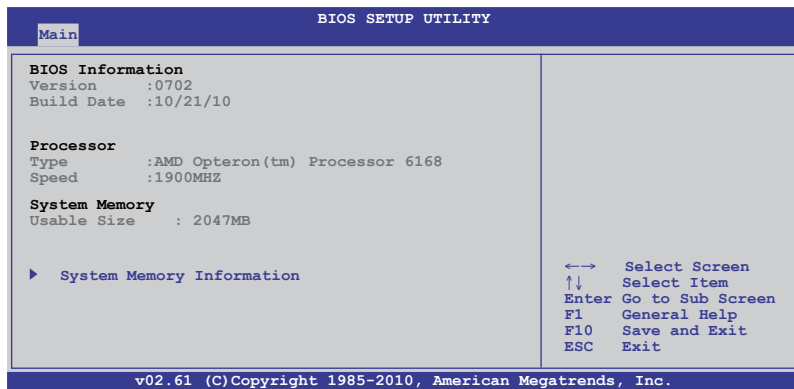

4.4 Advanced menu

The Advanced menu items allow you to change the settings for the CPU and other system devices.



Take caution when changing the settings of the Advanced menu items. Incorrect field values can cause the system to malfunction.

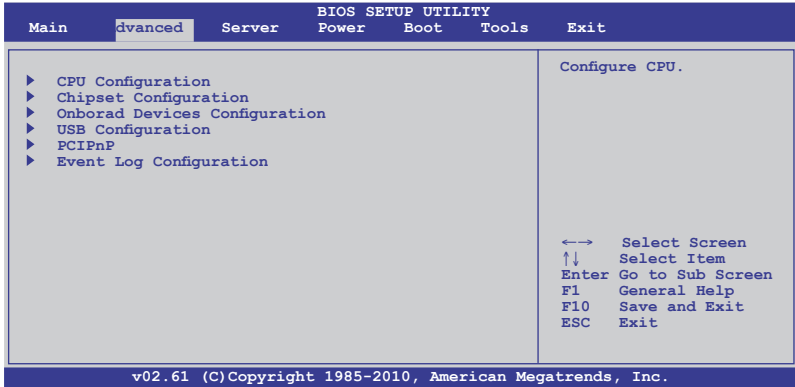

4.4.1 CPU Configuration

The items in this menu show the CPU-related information that the BIOS automatically detects. Some items may not appear if your CPU does not support the related functions.

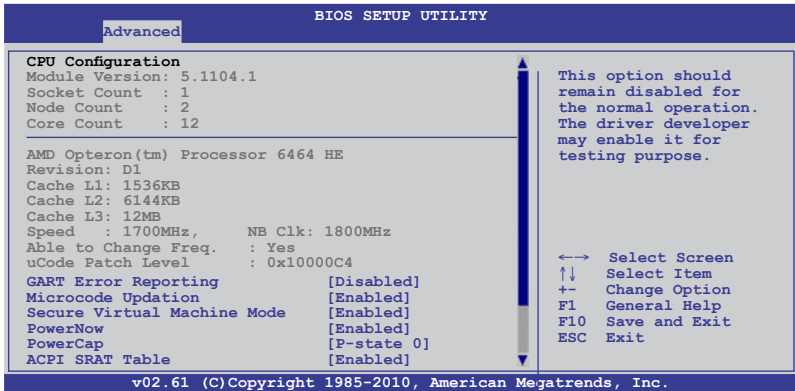

Scroll down for more items.

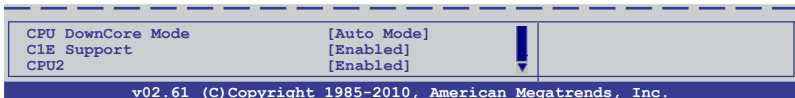

GART Error Reporting [Disabled]

This option should remain disabled for the normal operation. The driver developer may enable it for testing purpose. Configuration options: [Disabled] [Enabled]

Microcode Updation [Enabled]

Allows the system to update the Microcode automatically, enhancing system performance. Configuration options: [Disabled] [Enabled]

Secure Virtual Machine Mode [Enabled]

Allows you to enable or disable the AMD Secure Virtual Machine. Configuration options: [Disabled] [Enabled]

PowerNow [Enabled]

Allows you to enable or disable the generation of ACPI_PPC/_PSS/_PCT objects. Configuration options: [Enabled] [Disabled]

PowerCap [P-state 0]

Allows you to select the highest performance P-state in OS. Configuration options: [P-state 0] [P-state 1] [P-state 2] [P-state 3] [P-state 4]

ACPI SRAT Table [Enabled]

Allows you to enable or disable the building of ACPI SRAT Table. Configuration options: [Enabled] [Disabled]

CPU DownCore Mode [Auto Mode]

Allows you to select the CPU core level. Configuration options: [Auto Mode] [Maximum Core Level] [No Leveling] [2 Cores] [4 Cores] [6 Cores] [8 Cores] [10 Cores] [12 Cores]

C1E Support [Enabled]

Allows you to enable or disable the C1E support function. This item should be enabled in order to enable the Enhanced Halt State. Configuration options: [Disabled] [Enabled]

CPU2 [Enabled]

Allows you to enable or disable CPU2. Configuration options: [Enabled] [Disabled]

4.4.2 Chipset Configuration

The Chipset configuration menu allows you to change advanced chipset settings. Select an item then press <Enter> to display the submenu.

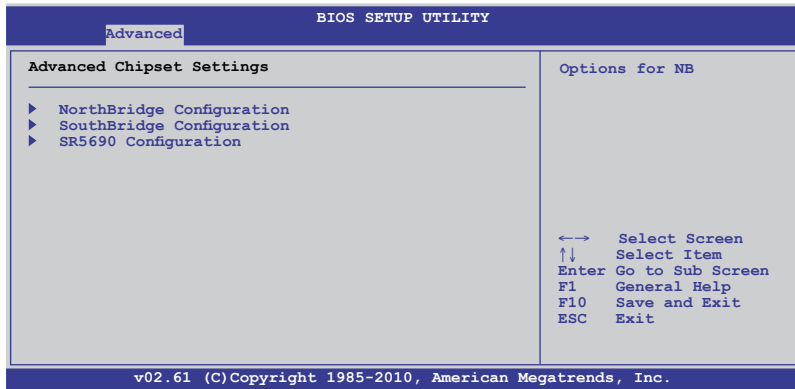

NorthBridge Configuration

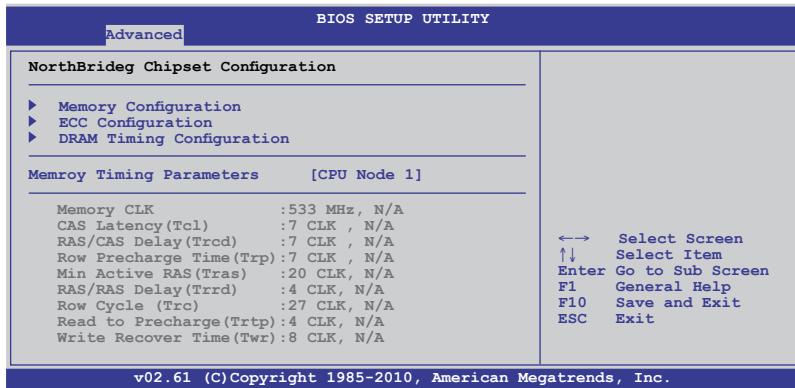

ECC Configuration

The screenshot shows the BIOS Setup Utility interface. At the top, it says 'BIOS SETUP UTILITY' and 'Advanced'. The main section is titled 'ECC Configuration'. On the left, there is a list of settings: 'ECC Mode' (set to [Basic]), 'DRAM ECC Enable' (set to [Enabled]), 'DRAM SCRUB REDIRECT' (set to [Disabled]), '4-Bit ECC Mode' (set to [Enabled]), 'DRAM BG Scrub' (set to [Disabled]), 'Data Cache BG Scrub' (set to [Disabled]), 'L2 Cache BG Scrub' (set to [Disabled]), and 'L3 Cache BG Scrub' (set to [Disabled]). On the right, there is a description: 'Set the level of ECC protection. Note: The 'Super' ECC mode dynamically sets the DRAM scrub rate so all of memory is scrubbed in 8 hours.' Below the description, there are navigation instructions: '<--> Select Screen', '↑↓ Select Item', '+- Change Option', 'F1 General Help', 'F10 Save and Exit', and 'ESC Exit'. At the bottom, it says 'v02.61 (C) Copyright 1985-2010, American Megatrends, Inc.'

ECC Mode [Basic]

Disables or sets the DRAM ECC mode that allows the hardware to report and correct memory errors.

Configuration options: [Disabled] [Basic] [Good] [Super] [Max] [User]

DRAM Timing Configuration

The screenshot shows the BIOS Setup Utility interface. At the top, it says 'BIOS SETUP UTILITY' and 'Advanced'. The main section is titled 'DRAM Timing Configuration'. On the left, there is a list of settings: 'DRAM Timing Config' (set to [Auto]). On the right, there is a sub-section titled 'Options' with two options: 'Auto' and 'Manual'. Below the options, there are navigation instructions: '<--> Select Screen', '↑↓ Select Item', '+- Change Option', 'F1 General Help', 'F10 Save and Exit', and 'ESC Exit'. At the bottom, it says 'v02.61 (C) Copyright 1985-2010, American Megatrends, Inc.'

DRAM Timing Config [Auto]

Allows you to select the DRAM timing mode. Configuration options: [Auto] [Manual]

Memory Clock Speed [400 MHz]

This item appears only when you set the **DRAM Timing Config** item to [Manual] and allows you to set the memory clock frequency.

Configuration options: [400 MHz] [533 MHz] [667 MHz]

Memory Timing Parameters [CPU Node 1]

Allows you to select which node's timing parameters to display.

SouthBridge Configuration

Advanced		BIOS SETUP UTILITY	
SouthBridge Chipset Configuration		Options for SB HD Azalia	
SP5100 CIMx Version : 5.7.0			
▶ SB Azalia Audio Configuration			
▶ SB Debug Configuration			
OHCI HC (Bus 0 Dev 18 Fn 0)	[Enabled]		
OHCI HC (Bus 0 Dev 18 Fn 1)	[Enabled]		
EHCI HC (Bus 0 Dev 18 Fn 2)	[Enabled]		
OHCI HC (Bus 0 Dev 19 Fn 0)	[Enabled]		
OHCI HC (Bus 0 Dev 19 Fn 1)	[Enabled]		
EHCI HC (Bus 0 Dev 19 Fn 2)	[Enabled]		
OHCI HC (Bus 0 Dev 20 Fn 5)	[Enabled]		
		←→ Select Screen	
		↑↓ Select Item	
		Enter Go to Sub Screen	
		F1 General Help	
		F10 Save and Exit	
		ESC Exit	
v02.61 (C) Copyright 1985-2010, American Megatrends, Inc.			

SB Azalia Audio Configuration

Advanced		Onchip HD Azalia Configuration	
HD Audio Azalia Device	[Auto]	Auto : When MIO installed then MIO will be enabled.	
HD Onboard PIN Config	[Enabled]		
Azalia Front Panel	[Auto]		
SDIN0 Pin Config	[Azalia]		
SDIN1 Pin Config	[Azalia]		
SDIN2 Pin Config	[Azalia]		
SDIN3 Pin Config	[Azalia]		
Azalia Snoop	[Disabled]		
Azalia Clock Gating	[Disabled]		
		←→ Select Screen	
		↑↓ Select Item	
		+- Change Option	
		F1 General Help	
		F10 Save and Exit	
		ESC Exit	
v02.61 (C) Copyright 1985-2010, American Megatrends, Inc.			

HD Audio Azalia Device [Auto]

Enables the High Definition Audio Azalia devie.

Configuration options: [Auto] [Disabled] [Enabled]

HD Onboard PIN Config [Enabled]

This item appears only when you set the previous item to [Auto] or [Enabled], and allows you to enable the HD Onboard PIN Config.

Configuration options: [Disabled] [Enabled]

Azalia Front Panel [Auto]

This item appears only when you set the previous item to [Enabled], and allows you to enable or disable the Azalia Front Panel.

Configuration options: [Auto] [Disabled]



The following items appear when **HD Audio Azalia Device** is set to [Auto] or [Enabled].

SDIN0/1/2/3 Pin Config [Azalia]

Selects the SDIN Pin setting.

Configuration options: [GPIO] [Azalia]

Azalia Snoop [Disabled]

Configuration options: [Disabled] [Enabled]

Azalia Clock Gating [Disabled]

Configuration options: [Disabled] [Enabled]

SB Debug Configuration

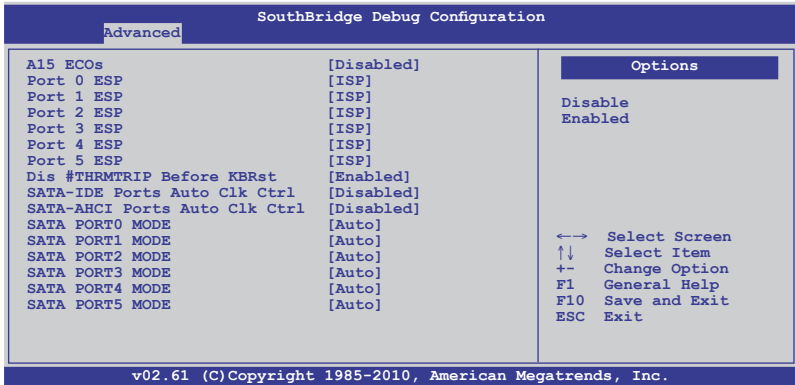

A15 ECOS [Disabled]

Configuration options: [Disabled] [Enabled]

Port 0/1/2/3/4/5 ESP [ISP]

Selects the type or the Port ESP help.

Configuration options: [ISP] [ESP]

Dis #THRMTRIP Before KBRst [Enabled]

Configuration options: [Enabled] [Disabled]

SATA-IDE Ports Auto Clk Ctrl [Disabled]

When set to [Enabled], the system will turn off the clocks for the unused SATA ports in IDE modes. Doing so will enable some power savings.

Configuration options: [Disabled] [Enabled]



The hot-plug function will be disabled when turning off the clock for the SATA port.

SATA-AHCI Ports Auto Clk Ctrl [Disabled]

When set to [Enabled], the system will turn off the clocks for the unused SATA ports in AHCI modes. Doing so will enable some power savings.

Configuration options: [Disabled] [Enabled]



The hot-plug function will be disabled when turning off the clock for the SATA port.

SATA PORT0/1/2/3/4/5 MODE [Auto]

When set to [GEN1], the SATA prot will run at GEN1 mode. Setting to [Auto] will leave the SATA port to run at the default mode.

Configuration options: [Auto] [GEN1]

OHCI HC(Bus 0 Dev 18 Fn 0) [Enabled]

Configuration options: [Disabled] [Enabled]

OHCI HC(Bus 0 Dev 18 Fn 1) [Enabled]

Configuration options: [Disabled] [Enabled]

EHCI HC(Bus 0 Dev 18 Fn 2) [Enabled]

Configuration options: [Disabled] [Enabled]

OHCI HC(Bus 0 Dev 19 Fn 0) [Enabled]

Configuration options: [Disabled] [Enabled]

OHCI HC(Bus 0 Dev 19 Fn 1) [Enabled]

Configuration options: [Disabled] [Enabled]

EHCI HC(Bus 0 Dev 19 Fn 2) [Enabled]

Configuration options: [Disabled] [Enabled]

OHCI HC (Bus 0 Dev 20 Fn 5) [Enabled]

Configuration options: [Disabled] [Enabled]

SR5690 Configuration

Advanced	
SR5690 Configuration <ul style="list-style-type: none">▶ PCI Express Configuration▶ Hyper Transport Configuration IOMMU [Disabled] VGA ROM Boot Priority [PCIE VGA Card] <ul style="list-style-type: none">▶ Debug Option	PCI Express Configuration ←→ Select Screen ↑↓ Select Item Enter Go to Sub Screen F1 General Help F10 Save and Exit ESC Exit
v02.61 (C) Copyright 1985-2010, American Megatrends, Inc.	

PCI Express Configuration

Advanced	
PCI Express Configuration <ul style="list-style-type: none">▶ PCIE Slot 1/2 Features▶ PCIE Slot 3 Features▶ PCIE Slot 4 Features▶ PCIE Slot 5 Features▶ PIKE Slot Features▶ NB-SB Port Features ▶ PCIE Slot 1/2 Core Setting▶ PCIE Slot 3 Core Setting▶ PCIE Slot 4/5 Core Setting▶ PIKE Slot Core Setting▶ SB Core Setting	PCI Express Configuration ←→ Select Screen ↑↓ Select Item Enter Go to Sub Screen F1 General Help F10 Save and Exit ESC Exit
v02.61 (C) Copyright 1985-2010, American Megatrends, Inc.	

PCIE Slot 1/2, PCIE Slot 3, PCIE Slot 4, PCIE Slot 4, PCIE Slot 5, PIKE Slot Features

Select an item, and then press <Enter> to display its sub-items.

Gen2 High Speed Mode [Auto]

Configuration options: [Auto] [Disabled] [Software Initiated] [Advertised RC]

Link ASPM [Disabled]

Configuration options: [Disabled] [L0s] [L1] [L0s & L1] [L0s Downstream] [L0s Downstream + L1]

Compliance Mode [Disabled]

Configuration options: [Disabled] [Enabled]

Lane Reversal [Disabled]

Configuration options: [Disabled] [Enabled]

Hyper Transport Configuration

Advanced

Hyper Transport Configuration

HT Extended Address	[Disabled]
HT3 Link Power State	[Auto]
UnitID Clumping	[Auto]
HT Link Tristate	[Auto]
NB Deempasies Level	[Disabled]

Options

Auto
Disabled
Enabled

←→ Select Screen
↑↓ Select Item
+- Change Option
F1 General Help
F10 Save and Exit
ESC Exit

v02.61 (C) Copyright 1985-2010, American Megatrends, Inc.

HT Extended Address [Disabled]

Configuration options: [Auto] [Disabled] [Enabled]

HT3 Link Power State [Auto]

Configuration options: [Auto] [LS0] [LS1] [LS2] [LS3]

UnitID Clumping [Auto]

Configuration options: [Auto] [Disabled] [UnitID 2/3] [UnitID B/C]
[UnitID 2/3&B/C]

HT Link Tristate [Auto]

Configuration options: [Auto] [Disabled] [CAD/CTL] [CAD/CTL/CLK]

NB Deempasies Level [Disabled]

Configuration options: [Disabled] [-0.4dB] [-1.32dB] [-2.08dB] [-3.1dB]
[-4.22dB] [-5.50dB] [-7.05dB]

IOMMU [Disabled]

Configuration options: [Disabled] [Enabled]

VGA ROM Boot Priority [PCIe VGA Card]

Allows you to select the VGA boot priority.

Configuration options: [PCIe VGA Card] [Onboard VGA]

Debug Option

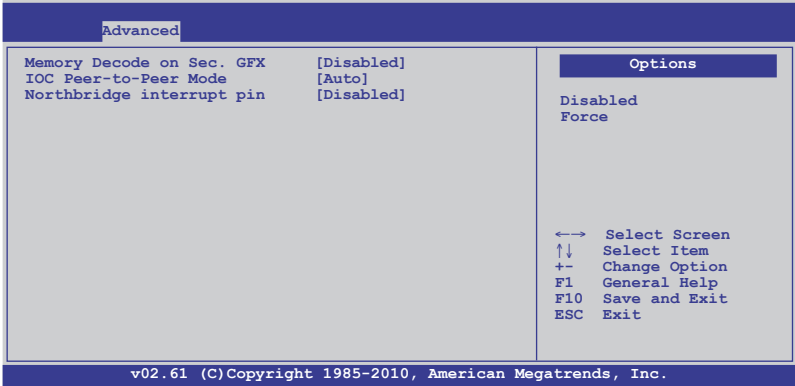

Memory Decode on Sec. GFX [Disabled]

Configuration options: [Disabled] [Force]

IOC Peer-to-Peer Mode [Auto]

Configuration options: [Auto] [Default] [Mode 1] [Mode 2]

Northbridge interrupt pin [Disabled]

Configuration options: [Disabled] [Enabled]

4.4.3 Onboard Devices Configuration

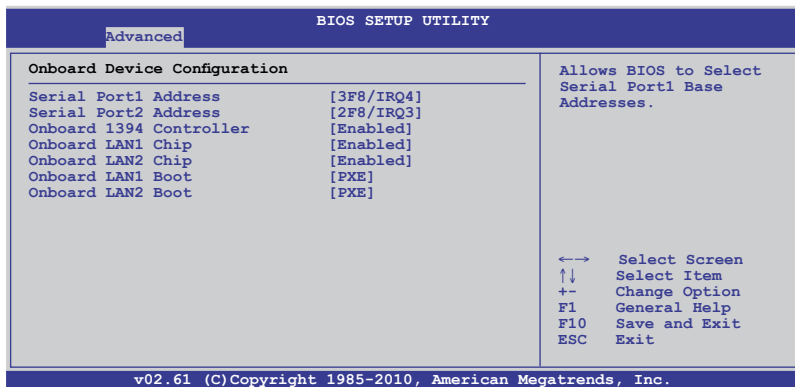

Serial Port1 Address [3F8/IRQ4]

Allows you to select the Serial Port1 base address.

Configuration options: [Disabled] [3F8/IRQ4] [3E8/IRQ4] [2E8/IRQ3]

Serial Port2 Address [2F8/IRQ3]

Allows you to select the Serial Port2 base address.

Configuration options: [Disabled] [2F8/IRQ3] [3E8/IRQ4] [2E8/IRQ3]

Onboard 1394 Controller [Enabled]

Enables or disables the onboard IEEE 1394 controller.

Configuration options: [Disabled] [Enabled]

Onboard LAN1/LAN2 Chip [Enabled]

Enables or disables the onboard LAN1/2 controller.

Configuration options: [Disabled] [Enabled]



The following items appear only when you set **Onboard LAN1/LAN2 Chip** to [Enabled].

Onboard LAN1/LAN2 Boot [PXE]

Allows you to configure the onboard LAN1/2 boot mode.

Configuration options: [Disabled] [PXE] [iSCSI]

4.4.4 USB Configuration

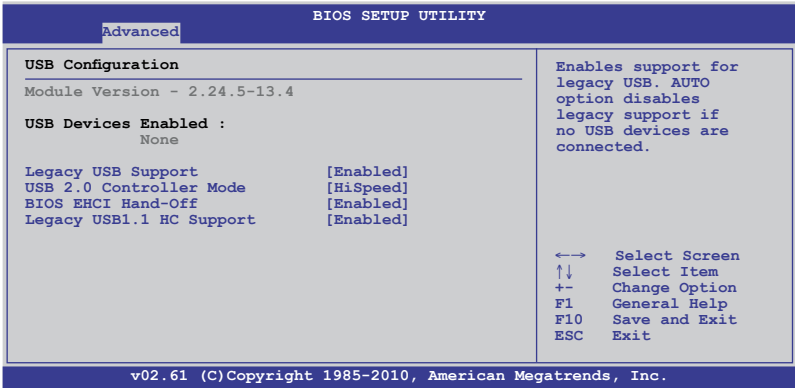

The **USB Devices Enabled** item shows the auto-detected values. If no USB device is detected, the item shows **None**.

Legacy USB Support [Enabled]

Allows you to enable or disable support for legacy USB devices. Setting to [Auto] allows the system to detect the presence of USB devices at startup. If detected, the USB controller legacy mode is enabled. If no USB device is detected, the legacy USB support is disabled. Configuration options: [Disabled] [Enabled] [Auto]

USB 2.0 Controller Mode [HiSpeed]

Allows you to set the USB 2.0 controller to HiSpeed (480Mbps) or FullSpeed (12Mbps). Configuration options: [FullSpeed] [HiSpeed]

BIOS EHCI Hand-Off [Enabled]

Enables or disables the BIOS EHCI hand-off support. Configuration options: [Disabled] [Enabled]



The following item appears only when you set **Legacy USB Support** to [Enabled] and [Auto].

Legacy USB1.1 HC Support [Enabled]

This item appears only when you set Legacy USB Support to [Enabled], and allows you to configure the Legacy USB1.1 HC support. Configuration options: [Disabled] [Enabled]

4.4.5 PCIPnP

The PCIPnP menu items allow you to change the advanced settings for PCI/PnP devices.



Take caution when changing the settings of the PCI/PnP Configuration menu items. Incorrect field values can cause the system to malfunction.

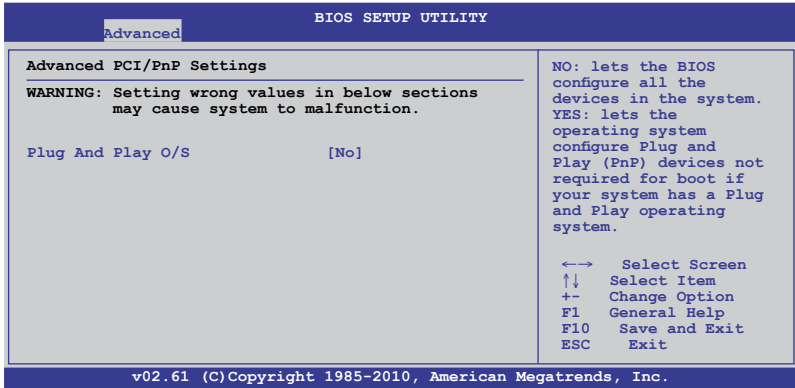

Plug And Play O/S [No]

When set to [No], BIOS configures all the devices in the system. When set to [Yes] and if you install a Plug and Play operating system, the operating system configures the Plug and Play devices not required for boot.

Configuration options: [No] [Yes]

4.4.6 Event Log Configuration

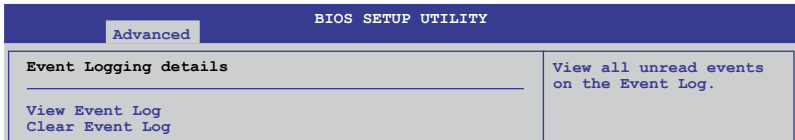

View Event Log

Press <Enter> to read all the unread event log.

Clear Event Log

Press <Enter> to clear all events on the event log.

4.5 Server menu

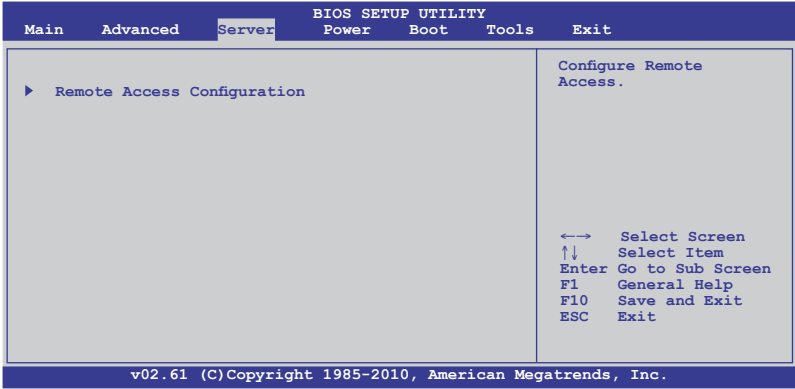

Remote Access Configuration

The items in this menu allows you to configure the Remote Access features. Select an item then press <Enter> to display the configuration options.

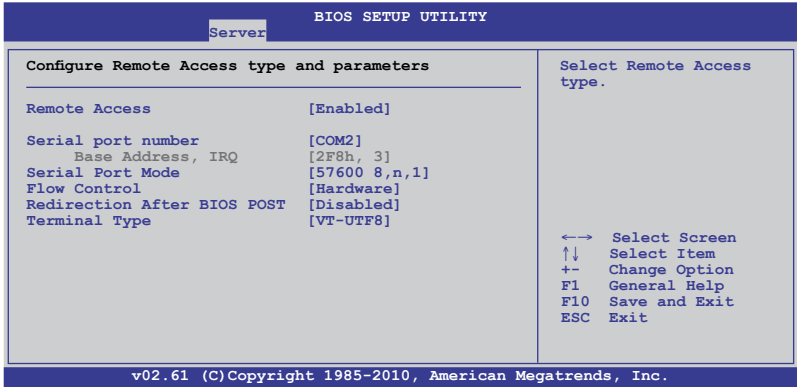

Remote Access [Enabled]

Enables or disables the remote access feature.

Configuration options: [Disabled] [Enabled]



The following items appear only when **Remote Access** is set to [Enabled].

Serial port number [COM2]

Selects the serial port for console redirection.

Configuration options: [COM1] [COM2]

Base Address. IRQ [2F8h, 3]

This item is not user-configurable and changes with the configuration of Serial port number.

Serial Port Mode [57600 8,n,1]

Sets the Serial port mode.

Configuration options: [115200 8,n,1] [57600 8,n,1] [38400 8,n,1] [19200 8,n,1] [09600 8,n,1]

Flow Control [Hardware]

Allows you to select the flow control for console redirection.

Configuration options: [None] [Hardware] [Software]

Redirection After BIOS POST [Disabled]

Sets the redirection mode after the BIOS Power-On Self-Test (POST). Some operating systems may not work when set to [Always].

Configuration options: [Disabled] [Boot Loader] [Always]

Terminal Type [VT-UTF8]

Allows you to select the target terminal type.

Configuration options: [ANSI] [VT100] [VT-UTF8]

4.6 Power menu

The Power menu items allow you to change the settings for the Advanced Power Management (APM). Select an item then press <Enter> to display the configuration options.

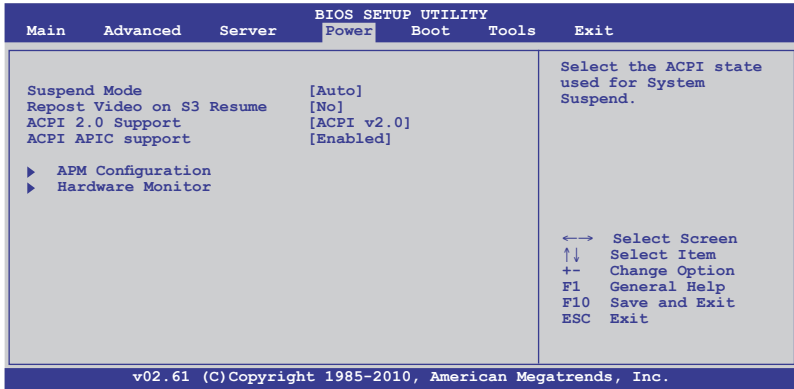

4.6.1 Suspend Mode [Auto]

Allows you to select the Advanced Configuration and Power Interface (ACPI) state to be used for system suspend.

Configuration options: [S1 (POS) only] [S3 only] [Auto]

4.6.2 Repost Video on S3 Resume [No]

Determines whether to invoke VGA BIOS POST on S3/STR resume.

Configuration options: [No] [Yes]

4.6.3 ACPI 2.0 Support [ACPI v2.0]

Specifies the Advanced Configuration and Power Interface (ACPI) version supported. Configuration options: [ACPI v1.0] [ACPI v2.0] [ACPI v3.0]

4.6.4 ACPI APIC support [Enabled]

Allows you to enable or disable the Advanced Configuration and Power Interface (ACPI) support in the Advanced Programmable Interrupt Controller (APIC). When set to Enabled, the ACPI APIC table pointer is included in the RSDT pointer list.

Configuration options: [Disabled] [Enabled]

4.6.5 APM Configuration

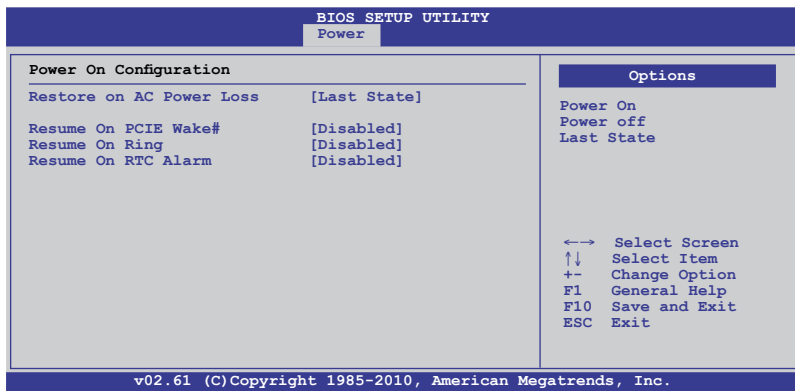

Restore on AC Power Loss [Last State]

When set to [Power Off], the system goes into off state after an AC power loss. When set to [Power On], the system will reboot after an AC power loss. When set to [Last State], the system goes into either off or on state, whatever the system state was before the AC power loss.

Configuration options: [Power Off] [Power On] [Last State]

Resume On PCIE Wake# [Disabled]

When set to [Enabled], the system enables the PCI-E to generate a wake event while the computer is in Soft-off mode.

Configuration options: [Disabled] [Enabled]

Resume On Ring [Disabled]

When set to [Enabled], the system enables RI to generate a wake event while the computer is in Soft-off mode. Configuration options: [Disabled] [Enabled]

Resume On RTC Alarm [Disabled]

Allows you to enable or disable RTC to generate a wake-up event.

Configuration options: [Disabled] [Enabled]



The following items appear only when the **Resume On RTC Alarm** item is set to [Enabled].

RTC Alarm Date [15]

To set the alarm date, highlight this item and press the <+> or <-> key to make the selection.

System Time [12:30:30]

Use the <ENTER>, <TAB> or <SHIFT-TAB> key to select a field. Use the <+> or <-> key to configure alarm time.

4.6.6 Hardware Monitor

BIOS SETUP UTILITY	
Power	
Hardware Monitor	
CPU1 Temperature	[27.5°C/ 81.5°F]
CPU2 Temperature	[N/A]
TR1 Temperature	[N/A]
TR2 Temperature	[N/A]
CPU Fan1 Speed	[1797RPM]
CPU Fan2 Speed	[N/A]
Front Fan1 Speed	[N/A]
Front Fan2 Speed	[N/A]
Front Fan3 Speed	[N/A]
Front Fan4 Speed	[N/A]
Front Fan5 Speed	[N/A]
Rear Fan1 Speed	[N/A]
Fan Speed Control	[Generic Mode]
VCORE1 Voltage	[1.090 V]
VCORE2 Voltage	[N/A]
P1DDR3 Voltage	[1.532 V]
P2DDR3 Voltage	[N/A]
P1 +1.2V Voltage	[1.220 V]

v02.61 (C)Copyright 1985-2010, American Megatrends, Inc.

Scroll down for more items.

P2 +1.2V Voltage	[N/A]
P1_VDDNB Voltage	[1.092 V]
+1.8V Voltage	[1.822 V]
+1.2V Voltage	[1.208 V]
+1.1V Voltage	[1.208 V]
+12V Voltage	[12.360 V]
+5V Voltage	[5.036 V]
+3.3V Voltage	[3.282 V]
+5VSB Voltage	[5.088 V]
+3.3VSB Voltage	[3.306 V]
VBAT Voltage	[3.132 V]

v02.61 (C)Copyright 1985-2010, American Megatrends, Inc.

CPU1/2 Temperature [xxx°C/xxx°F]

TR1/2 Temperature [xxx°C/xxx°F]

The onboard hardware monitor automatically detects and displays the motherboard component and CPU temperatures. Select [Ignored] if you do not wish to display the detected temperatures.

CPU Fan1/2; Front Fan1–5 Speed [xxxxRPM] or [Ignored] / [N/A]

Rear Fan1 Speed [xxxxRPM] or [Ignored] / [N/A]

The onboard hardware monitor automatically detects and displays the speed of CPU fans, front fans, and rear fan in rotations per minute (RPM). If the fan is not connected to the motherboard, the field shows [N/A].

Fan Speed Control [Generic Mode]

Allows you to configure the ASUS Smart Fan feature that smartly adjusts the fan speeds for more efficient system operation.

Configuration options: [Full Speed Mode] [Whisper Mode] [Generic Mode]
[High Density Mode]

**VCORE1/2 Voltage; P1/2DDR3 Voltage; P1/2_+1.2V Voltage;
P1_VDDNB Voltage; +1.8V Voltage; +1.2V Voltage; +1.1V Voltage;
+12V Voltage; +5V Voltage; +3.3V Voltage; +5VSB Voltage;
+3.3VSB Voltage; VBAT Voltage [xxxxV] or [ignored]**

The onboard hardware monitor automatically detects the voltage output through the onboard voltage regulators. Select [Ignored] if you do not want to detect this item.

4.7 Boot menu

The Boot menu items allow you to change the system boot options. Select an item then press <Enter> to display the submenu.

BIOS SETUP UTILITY						
Main	Advanced	Server	Power	Boot	Tools	Exit
Boot Settings			Specifies the Boot Device Priority sequence.			
▶ Boot Device Priority			A virtual floppy disk drive (Floppy Drive B:) may appear when you set the CD-ROM drive as the first boot device.			
▶ Hard Disk Drives						
▶ CDROM Drives						
▶ Boot Settings Configuration						
▶ Security						
			←→ Select Screen			
			↑↓ Select Item			
			Enter Go to Sub Screen			
			F1 General Help			
			F10 Save and Exit			
			ESC Exit			
v02.61 (C)Copyright 1985-2010, American Megatrends, Inc.						

4.7.1 Boot Device Priority

BIOS SETUP UTILITY			
Boot			
Boot Device Priority		Specifies the Boot Device Priority sequence.	
1st Boot Device	[Removable Dev.]	A device enclosed in parenthesis has been disabled in the corresponding type menu.	
2nd Boot Device	[ATAPI CD-ROM]		
3rd Boot Device	[Hard Drive]		
4th Boot Device	[Network:IBA GE Slot]		
5th Boot Device	[Network:IBA GE Slot]		
		←→ Select Screen	
		↑↓ Select Item	
		+- Change Option	
		F1 General Help	
		F10 Save and Exit	
		ESC Exit	
v02.61 (C)Copyright 1985-2010, American Megatrends, Inc.			

1st-xxth Boot Device [XXXXXXXX]

These items specify the boot device priority sequence from the available devices. The number of device items that appears on the screen depends on the number of devices installed in the system.

Configuration options: [Removable Dev.] [ATAPI CD-ROM] [Hard Drive] [Network:IBA GE Slot 0300 v1234] [Ntework:IBA GE Slot 0200 v1324] [Disabled]

4.7.2 Hard Disk Drives; CDROM Drives

These two items appear only when you install hard disk drives or optical drives to you system. These items allow you to specify the boot priority sequence of the hard disk drives or the optical drives.

4.7.3 Boot Settings Configuration

BIOS SETUP UTILITY	
Boot	
Boot Settings Configuration	
Quick Boot	[Enabled]
Full Screen Logo	[Enabled]
AddOn ROM Display Mode	[Force BIOS]
Bootup Num-Lock	[On]
Wait For 'F1' If Error	[Enabled]
Hit 'DEL' Message Display	[Enabled]
Interrupt 19 Capture	[Enabled]
Boot Device Seeking	[Endless PXE]

Quick Boot [Enabled]

Enabling this item allows the BIOS to skip some power on self tests (POST) while booting to decrease the time needed to boot the system. When set to [Disabled], BIOS performs all the POST items. Configuration options: [Disabled] [Enabled]

Full Screen Logo [Enabled]

Allows you to enable or disable the full screen logo display feature. Configuration options: [Disabled] [Enabled]



Set this item to [Enabled] to use the ASUS MyLogo2™ feature.

AddOn ROM Display Mode [Force BIOS]

Allows you to set the display mode for Options ROM. Configuration options: [Force BIOS] [Keep Current]

Bootup Num-Lock [On]

Allows you to select the power-on state for the NumLock. Configuration options: [Off] [On]

Wait For 'F1' If Error [Enabled]

When set to [Enabled], the system waits for the <F1> key to be pressed when error occurs. Configuration options: [Disabled] [Enabled]

Hit 'DEL' Message Display [Enabled]

When set to [Enabled], the system displays the message "Press DEL to run Setup" during POST. Configuration options: [Disabled] [Enabled]

Interrupt 19 Capture [Enabled]

When set to [Enabled], this function allows the option ROMs to trap Interrupt 19. Configuration options: [Disabled] [Enabled]

Boot Device Seeking [Endless PXE]

When set to [Endless PXE], the system will continuously seek the remote boot image until the boot image is found or the user abort (press <Ctrl> + <Alt> +). When set to [Normal], the system will seek the remote boot image once. Configuration options: [Endless PXE] [Normal]

4.7.4 Security

The Security menu items allow you to change the system security settings. Select an item then press <Enter> to display the configuration options.

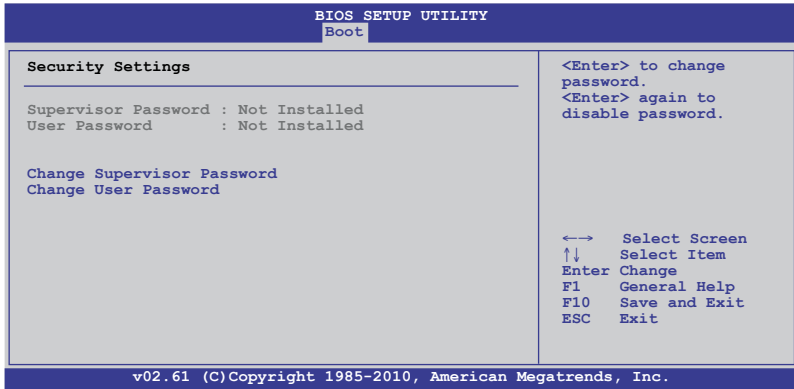

Change Supervisor Password

Select this item to set or change the supervisor password. The **Supervisor Password** item on top of the screen shows the default **Not Installed**. After you set a password, this item shows **Installed**.

To set a Supervisor Password:

1. Select the **Change Supervisor Password** item and press <Enter>.
2. From the password box, type a password composed of at least six letters and/or numbers, then press <Enter>.
3. Confirm the password when prompted.

The message "Password Installed" appears after you successfully set your password.

To change the supervisor password, follow the same steps as in setting a user password.

To clear the supervisor password, select the **Change Supervisor Password** then press <Enter>. The message "Password Uninstalled" appears.



If you forget your BIOS password, you can clear it by erasing the CMOS Real Time Clock (RTC) RAM. See section **2.6 Jumpers** for information on how to erase the RTC RAM.

After you have set a supervisor password, the other items appear to allow you to change other security settings.

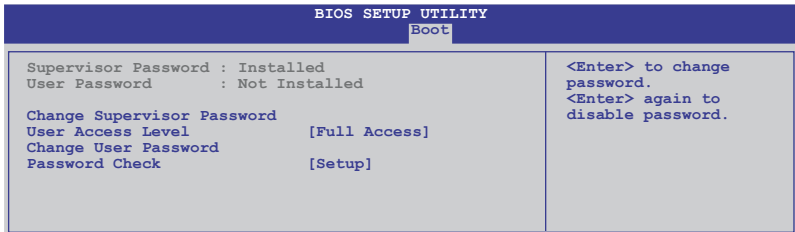

User Access Level [Full Access]

This item allows you to select the access restriction to the Setup items. Configuration options: [No Access] [View Only] [Limited] [Full Access]

No Access prevents user access to the Setup utility.

View Only allows access but does not allow change to any field.

Limited allows changes only to selected fields, such as Date and Time.

Full Access allows viewing and changing all the fields in the Setup utility.

Change User Password

Select this item to set or change the user password. The **User Password** item on top of the screen shows the default **Not Installed**. After you set a password, this item shows Installed.

To set a User Password:

1. Select the **Change User Password** item and press <Enter>.
2. On the password box that appears, type a password composed of at least six letters and/or numbers, then press <Enter>.
3. Confirm the password when prompted.

The message "Password Installed" appears after you set your password successfully.

To change the user password, follow the same steps as in setting a user password.

Password Check [Setup]

When set to [Setup], BIOS checks for user password when accessing the Setup utility. When set to [Always], BIOS checks for user password both when accessing Setup and booting the system. Configuration options: [Setup] [Always]

4.8 Tools menu

The Tools menu items allow you to configure options for special functions. Select an item then press <Enter> to display the submenu.

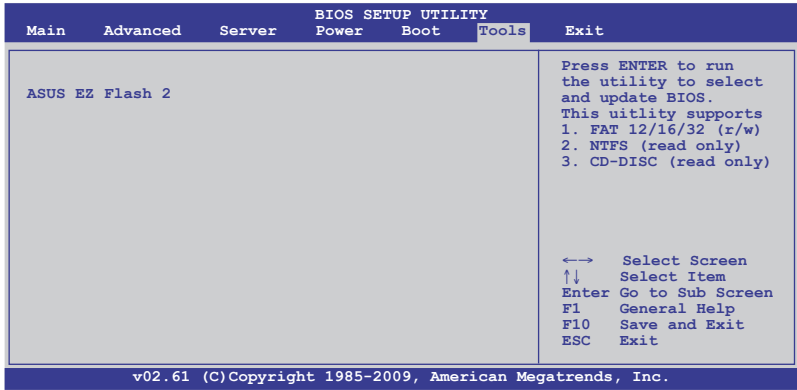

ASUS EZ Flash 2

Allows you to run ASUS EZ Flash 2. When you press <Enter>, a confirmation message appears. Use the left/right arrow key to select between [Yes] or [No], then press <Enter> to confirm your choice. Check section **4.1.1 ASUS EZ Flash 2 utility** for details.

4.9 Exit menu

The Exit menu items allow you to load the optimal or failsafe default values for the BIOS items, and save or discard your changes to the BIOS items.

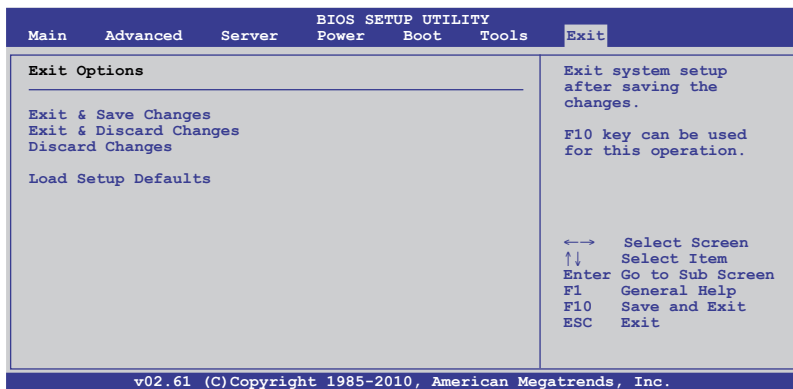

Pressing <Esc> does not immediately exit this menu. Select one of the options from this menu or <F10> from the legend bar to exit.

Exit & Save Changes

Once you are finished making your selections, choose this option from the Exit menu to ensure the values you selected are saved to the CMOS RAM. An onboard backup battery sustains the CMOS RAM so it stays on even when the PC is turned off. When you select this option, a confirmation window appears. Select YES to save changes and exit.



If you attempt to exit the Setup program without saving your changes, the program prompts you with a message asking if you want to save your changes before exiting. Press <Enter> to save the changes while exiting.

Exit & Discard Changes

Select this option only if you do not want to save the changes that you made to the Setup program. If you made changes to fields other than System Date, System Time, and Password, the BIOS asks for a confirmation before exiting.

Discard Changes

This option allows you to discard the selections you made and restore the previously saved values. After selecting this option, a confirmation appears. Select YES to discard any changes and load the previously saved values.

Load Setup Defaults

This option allows you to load the default values for each of the parameters on the Setup menus. When you select this option or if you press <F5>, a confirmation window appears. Select **YES** to load default values. Select **Exit & Save Changes** or make other changes before saving the values to the non-volatile RAM.

This chapter provides instructions for setting up, creating, and configuring RAID sets using the available utilities.

5 RAID configuration

5.1 Setting up RAID

5.1.1 RAID definitions

RAID 0 (*Data striping*) optimizes two identical hard disk drives to read and write data in parallel, interleaved stacks. Two hard disks perform the same work as a single drive but at a sustained data transfer rate, double that of a single disk alone, thus improving data access and storage. Use of two new identical hard disk drives is required for this setup.

RAID 1 (*Data mirroring*) copies and maintains an identical image of data from one drive to a second drive. If one drive fails, the disk array management software directs all applications to the surviving drive as it contains a complete copy of the data in the other drive. This RAID configuration provides data protection and increases fault tolerance to the entire system. Use two new drives or use an existing drive and a new drive for this setup. The new drive must be of the same size or larger than the existing drive.

RAID 10 is data striping and data mirroring combined without parity (redundancy data) having to be calculated and written. With the RAID 10 configuration you get all the benefits of both RAID 0 and RAID 1 configurations. Use four new hard disk drives or use an existing drive and three new drives for this setup.

RAID 5 stripes both data and parity information across three or more hard disk drives. Among the advantages of RAID 5 configuration include better HDD performance, fault tolerance, and higher storage capacity. The RAID 5 configuration is best suited for transaction processing, relational database applications, enterprise resource planning, and other business systems. Use a minimum of three identical hard disk drives for this setup.

JBOD (Spanning) stands for Just a Bunch of Disks and refers to hard disk drives that are not yet configured as a RAID set. This configuration stores the same data redundantly on multiple disks that appear as a single disk on the operating system. Spanning does not deliver any advantage over using separate disks independently and does not provide fault tolerance or other RAID performance benefits.

SPAN helps to combine the capacity of multiple physical disk drives into one single large drive volume, making the small-sized disk drives more useful. The disk drives in this mode need not to be identical in size or speed.



If you want to boot the system from a hard disk drive included in a created RAID set, copy first the RAID driver from the support CD to a floppy disk before you install an operating system to the selected hard disk drive.

5.1.2 Installing hard disk drives

The motherboard supports Serial ATA for RAID set configuration. For optimal performance, install identical drives of the same model and capacity when creating a disk array.

To install the SATA hard disks for RAID configuration:

1. Install the SATA hard disks into the drive bays following the instructions in the system user guide.
2. Connect a SATA signal cable to the signal connector at the back of each drive and to the SATA connector on the motherboard.
3. Connect a SATA power cable to the power connector on each drive.

5.1.3 Setting the RAID item in BIOS

You must set the RAID item in the BIOS Setup before you can create a RAID set from SATA hard disk drives attached to the SATA connectors supported by AMD SP5100 chipset. To do this:

1. Enter the BIOS Setup during POST.
2. Go to the **Main Menu > Storage Configuration**, then press <Enter>.
3. Set **SATA Port1-4** to [RAID] and **SATA Port5-6** will be set to [RAID] too.
4. Press <F10> to save your changes and exit the BIOS Setup.



Refer to Chapter 4 for details on entering and navigating through the BIOS Setup.

5.2 FastBuild Utility

The FastBuild Utility allows you to create RAID 0, RAID 1, RAID 10 ,and RAID 5, SPAN and JBOD set(s) from Serial ATA hard disk drives that are connected to the Serial ATA connectors supported by the Promise RAID.

To enter the FastBuild Utility:

1. Install all the Serial ATA hard disk drives at Red SATA Connector.
2. Turn on the system.
3. During POST, press <Ctrl> + <F> to enter the utility main menu.

```
FastBuild (tm) Utility (c) 2004-2010 Promise Technology, Inc.
[ Main Menu ]

View Drive Assignment .....[ 1 ]
LD View / LD Define Menu .....[ 2 ]
Delete LD Menu .....[ 3 ]
Controller Configuration .....[ 4 ]

[ Keys Available ]
Press 1..4 to Select Option [ESC]Exit
```



The RAID BIOS setup screens shown in this section are for reference only and may not exactly match the items on your screen.

5.2.1 Creating a RAID set (RAID 0, RAID 1, RAID 10, RAID 5, SPAN or JBOD)

To create a RAID set:

1. From the main control panel, press <2> to enter the **LD View Menu**.

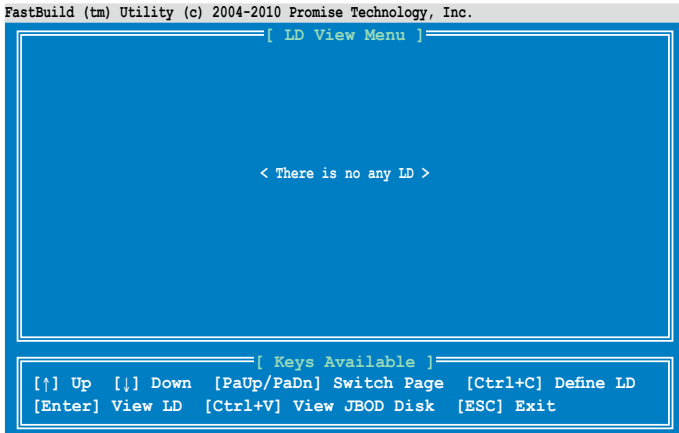
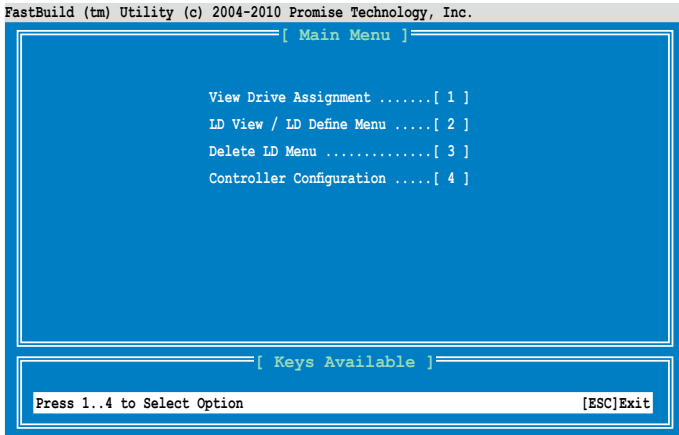

- Press <Ctrl> + <C> to define an LD and use <Spacebar> to select a desired RAID mode.

```
FastBuild (tm) Utility (c) 2004-2010 Promise Technology, Inc.
[ LD Define Menu ]
LD No  LD Name          RAID Mode  Drv
LD  1  Logical Drive 1  RAID 1    0

Stripe Block      128 KB      Initialization  Fast
Gigabyte Boundary ON
Read Policy        NA          Write Policy    WriteThru

[ Drives Assignments ]
Port:ID  Drive Model  Capabilities  Capacity (GB)  Assignment
01:01    HDTXXXXXXXXXX SATA 3G        250.05         N
02:01    HDTXXXXXXXXXX SATA 3G        250.05         N
03:01    HDTXXXXXXXXXX SATA 3G        250.05         N
04:01    HDTXXXXXXXXXX SATA 3G        250.05         N

[ Keys Available ]
[↑] Up [↓] Down [PaUp/PaDn] Switch Page [Space] Change Option
[Ctrl+Y] Save [ESC] Exit
```

- Use <Spacebar> to set Read Policy to Read Cache and Write Policy to WriteBack.

```
FastBuild (tm) Utility (c) 2004-2010 Promise Technology, Inc.
[ LD Define Menu ]
LD No  LD Name          RAID Mode  Drv
LD  1  Logical Drive 1  RAID 1    0

Stripe Block      128 KB      Initialization  Fast
Gigabyte Boundary ON
Read Policy        Read Cache   Write Policy    WriteBack

[ Drives Assignments ]
Port:ID  Drive Model  Capabilities  Capacity (GB)  Assignment
01:01    HDTXXXXXXXXXX SATA 3G        250.05         N
02:01    HDTXXXXXXXXXX SATA 3G        250.05         N
03:01    HDTXXXXXXXXXX SATA 3G        250.05         N
04:01    HDTXXXXXXXXXX SATA 3G        250.05         N

[ Keys Available ]
[↑] Up [↓] Down [PaUp/PaDn] Switch Page [Space] Change Option
[Ctrl+Y] Save [ESC] Exit
```

- After you have selected the desired RAID mode, use the down arrow key to select desired disks for the RAID set.

```
FastBuild (tm) Utility (c) 2004-2010 Promise Technology, Inc.
[ LD Define Menu ]
LD No  LD Name          RAID Mode  Drv
LD  1  Logical Drive 1  RAID 1    1

Stripe Block      128 KB      Initialization  Fast
Gigabyte Boundary ON          Write Policy    WriteBack
Read Policy

[ Drives Assignments ]
Port:ID  Drive Model  Capabilities  Capacity(GB)  Assignment
01:01   HDTXXXXXXXXXXXXXXXXX  SATA 3G      250.05        Y
02:01   HDTXXXXXXXXXXXXXXXXX  SATA 3G      250.05        N
03:01   HDTXXXXXXXXXXXXXXXXX  SATA 3G      250.05        N
04:01   HDTXXXXXXXXXXXXXXXXX  SATA 3G      250.05        N

[ Keys Available ]
[↑] Up [↓] Down [PaUp/PaDn] Switch Page [Space] Change Option
[Ctrl+Y] Save [ESC] Exit
```

- After you have selected desired disks for the RAID set, press <Ctrl> + <Y> to start building the RAID set.

```
FastBuild (tm) Utility (c) 2004-2010 Promise Technology, Inc.
[ LD Define Menu ]
LD No  LD Name          RAID Mode  Drv
LD  1  Logical Drive 1  RAID 1    2

Stripe Block      128 KB      Initialization  Fast
Gigabyte Boundary ON          Write Policy    WriteBack
Read Policy

[ Keys Available ]
[↑] Up [↓] Down [PaUp/PaDn] Switch Page [Space] Change Option
[Ctrl+Y] Save [ESC] Exit
```

Please Press Ctr-Y key to input the LD name
or press any key to exit.
If you do not input any LD name, the default
LD name will be used.

```
Port:ID  Drive Model  Capabilities  Capacity(GB)  Assignment
01:01   HDTXXXXXXXXXXXXXXXXX  SATA 3G      250.05        Y
02:01   HDTXXXXXXXXXXXXXXXXX  SATA 3G      250.05        Y
03:01   HDTXXXXXXXXXXXXXXXXX  SATA 3G      250.05        N
04:01   HDTXXXXXXXXXXXXXXXXX  SATA 3G      250.05        N
```

- Press <Ctrl> + <Y> again and enter the LD name. Press <Enter> to continue.

```
FastBuild (tm) Utility (c) 2004-2010 Promise Technology, Inc.
----- [ LD Define Menu ] -----
LD No  LD Name                      RAID Mode  Drv
LD  1  Logical Drive 1              RAID 1     2

Stripe Block      128 KB      Initialization  Fast
Gigabyte Boundary ON          Read Cache     Write Policy    WriteBack

----- [ Drives Assignments ] -----
Port:ID  Drive Model  Capabilities  Capacity(GB)  Assignment
01:01    HDTXXXXXXXXXX SATA 3G       250.05        Y
02:01    HDTXXXXXXXXXX SATA 3G       250.05        Y
03:01    [ ]           [ ]           [ ]           [ ]
04:01    [ ]           [ ]           [ ]           [ ]
Enter the LD name here: XXXX

----- [ Keys Available ] -----
[↑] Up [↓] Down [PaUp/PaDn] Switch Page [Space] Change Option
[Ctrl+Y] Save [ESC] Exit
```

- All the data on the selected disk drives will be deleted. Press <Ctrl> + <Y> to continue.

```
FastBuild (tm) Utility (c) 2004-2010 Promise Technology, Inc.
----- [ LD Define Menu ] -----
LD No  LD Name                      RAID Mode  Drv
LD  1  Logical Drive 1              RAID 1     2

Stripe Block      128 KB      Initialization  Fast
Gigabyte Boundary ON          Read Cache     Write Policy    WriteBack

----- [ Drives Assignments ] -----
Port:ID  Dri  Fast Initialization Option has been selected.  Assignment
01:01    HDT  It wil erase the MBR data of the disks.          Y
02:01    HDT  <Press Ctrl-Y Key if you are sure to erase it>    Y
03:01    HDT  <Press any other key to ignore this option>      N
04:01    HDT  [ ]           [ ]           [ ]           [ ]

----- [ Keys Available ] -----
[↑] Up [↓] Down [PaUp/PaDn] Switch Page [Space] Change Option
[Ctrl+Y] Save [ESC] Exit
```

- Press <Ctrl> + <Y> to modify the disk array size or press any other key to use all the available capacity of the disk drive.

```
FastBuild (tm) Utility (c) 2004-2010 Promise Technology, Inc.
[ LD Define Menu ]
LD No  LD Name          RAID Mode  Drv
LD 1   Logical Drive 1  RAID 1    2

Stripe Block      128 KB      Initialization  Fast
Gigabyte Boundary ON          Read Cache     Write Policy    WriteBack

[ Drives Assignments ]
Port:ID  Drive Model      Capabilities  Capacity(GB)  Assignment
01:01   HDTXXXXXXXXXXXX  SATA 3G      250.05        Y
02:01   HDTXXXXXXXXXXXX  SATA 3G      250.05        Y
03:01   HDTXXXXXXXXXXXX  SATA 3G      250.05        N
04:01   HDTXXXXXXXXXXXX  SATA 3G      250.05        N

Press Ctrl-Y to Modify Array Capacity or press
any other key to use maximum capacity...

[{} Up [{} Down [{}PaUp/PaDn] Switch Page [{}Space] Change Option
Fast Initializing...
```

- Use the number keys to enter your desired array capacity.

```
FastBuild (tm) Utility (c) 2004-2010 Promise Technology, Inc.
[ LD Define Menu ]
LD No  LD Name          RAID Mode  Drv
LD 1   Logical Drive 1  RAID 1    2

Stripe Block      128 KB      Initialization  Fast
Gigabyte Boundary ON          Read Cache     Write Policy    WriteBack

[ Drives Assignments ]
Port:ID  Drive Model      Capabilities  Capacity(GB)  Assignment
01:01   HDTXXXXXXXXXXXX  SATA 3G      250.05        Y
02:01   HDTXXXXXXXXXXXX  SATA 3G      250.05        Y
03:01   HDTXXXXXXXXXXXX  SATA 3G      250.05        N
04:01   HDTXXXXXXXXXXXX  SATA 3G      250.05        N
Enter array capacity (in GB) here: 200

[ Keys Available ]
[{} Up [{} Down [{}PaUp/PaDn] Switch Page [{}Space] Change Option
[0-9] Input Capacity [Enter] Save [BackSpace] Delete [Esc] Exit
```

- The RAID set has been built successfully and press <Enter> to view the content.

```
FastBuild (tm) Utility (c) 2004-2010 Promise Technology, Inc.
[ LD View Menu ]
LD No      RAID Mode   Drv      Capacity(GB)   Status
LD 1      RAID 1       2        199.99         Functional

[ Keys Available ]
[↑] Up [↓] Down [PaUp/PaDn] Switch Page [Ctrl+C] Define LD
[Enter] View LD [Ctrl+V] View JBOD Disk [ESC] Exit
```

- Press any key to return to the main control panel.

```
FastBuild (tm) Utility (c) 2004-2010 Promise Technology, Inc.
[ View LD Definition Menu ]
LD No  LD Name      RAID Mode   Drv      Capacity(GB)
LD 1   RAID1       RAID 1      2        199.99

Stripe Block      NA
Read Policy       Read Cache     Write Policy     WriteBack

[ Drives Assignments ]
Port:ID  Drive Model      Capabilities   Capacity(GB)
01:01   HDTXXXXXXXXXXXX  SATA 3G       250.05
02:01   HDTXXXXXXXXXXXX  SATA 3G       250.05

Any Key To Continue.....
```

5.2.2 Deleting a RAID set

To delete a RAID set:

1. From the main control panel, press <3> to enter the **Delete LD Menu**.

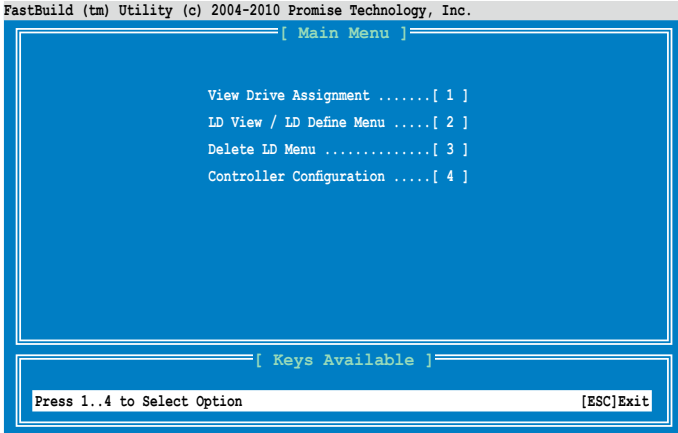

2. Select the RAID set you would like to delete and press /<Alt>+<D> to delete the selected RAID set.

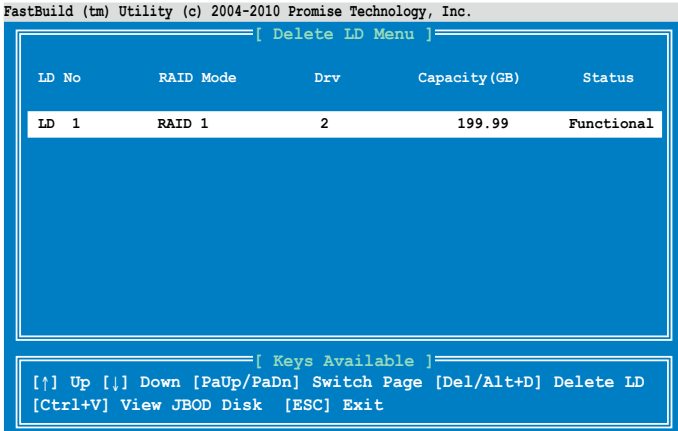

3. Press <Ctrl>+<Y> to confirm and delete the selected RAID set.

```
FastBuild (tm) Utility (c) 2004-2010 Promise Technology, Inc.
[ View LD Definition Menu ]
LD No  LD Name          RAID Mode  Drv   Capacity (GB)
LD 1   RAID1            RAID 1     2     199.99

Stripe Block      NA
Read Policy       NA           Write Policy  WriteThru

[ Drives Assignments ]
Port:ID  Drive Model          Capabilities  Capacity (GB)
01:01   HDTXXXXXXXXXXXXXX  SATA 3G      250.05
02:01   HDTXXXXXXXXXXXXXX  SATA 3G      250.05

Press Ctrl-Y to delete the data in the disk!
or press any other key to abort...
```

4. The selected RAID set has been deleted.

```
FastBuild (tm) Utility (c) 2004-2010 Promise Technology, Inc.
[ Delete LD Menu ]

< There is no any LD >

[ Keys Available ]
[↑] Up [↓] Down [PaUp/PaDn] Switch Page [Del/Alt+D] Delete LD
[Ctrl+V] View JBOD Disk [ESC] Exit
```

5.2.3 Viewing the Drive Assignment

To view the drive assignment:

1. From the main control panel, press <1> to enter the **Drive Assignment Menu**.

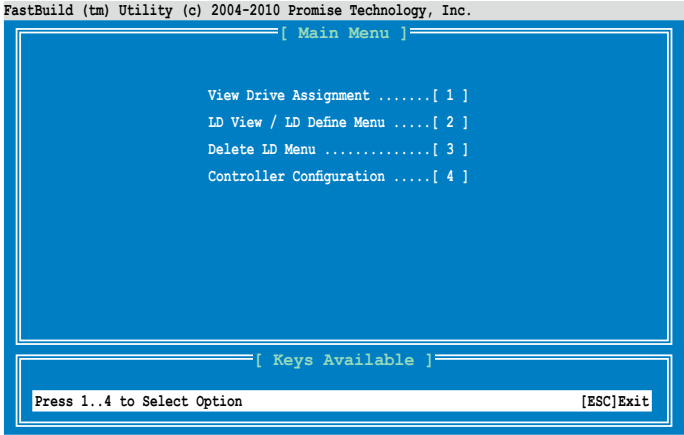

2. The drive assignment is displayed as shown.

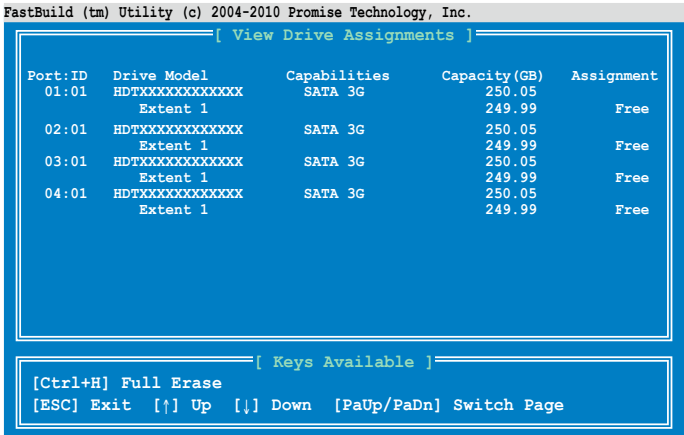

5.2.4 Viewing the Controller Configuration

To view the controller configuration:

1. From the main control panel, press <4> to enter the **Controller Configuration Menu**.

```
FastBuild (tm) Utility (c) 2004-2010 Promise Technology, Inc.
[ Main Menu ]

View Drive Assignment .....[ 1 ]
LD View / LD Define Menu .....[ 2 ]
Delete LD Menu .....[ 3 ]
Controller Configuration .....[ 4 ]

[ Keys Available ]
Press 1..4 to Select Option [ESC]Exit
```

2. The system resources configuration is displayed as shown.

```
FastBuild (tm) Utility (c) 2004-2010 Promise Technology, Inc.
[ Adapter Configuration - Options ]
No Parameters Defined for Current Disk(s)...

[ System Resources Configuration ]

Controller IRQ: 10
AHCI HBA MMIO Base Address: FAFFE400

[ Keys Available ]
[ESC] Exit
```

This chapter provides instructions for installing the necessary drivers for different system components.

6 Driver installation

6.1 RAID driver installation

After creating the RAID sets for your server system, you are now ready to install an operating system to the independent hard disk drive or bootable array. This part provides instructions on how to install the RAID controller drivers during OS installation.



The RAID card driver might be included in the Linux OS installation CD, and could be loaded automatically during the OS installation. However, we recommend you use the RAID driver packaged in the RAID card support CD for a better reliability.

6.1.1 Creating a RAID driver disk



- You may have to use another system to create the RAID driver disk from the system/motherboard support CD or from the Internet.
- When you use a SATA optical drive and PROMISE® RAID, you cannot boot into FreeDOS using the support CD. Either reset **SATA Port1 - Port4** in BIOS to [IDE] and boot again or create the RAID driver disk in another computer.

A floppy disk with the RAID driver is required when installing Windows® or Linux operating system on a hard disk drive that is included in a RAID set. You can create a RAID driver disk in DOS (using the Makedisk application in the support CD).

To create a RAID driver disk in DOS environment:

1. Place the motherboard support CD in the optical drive.
2. Restart the computer, then enter the BIOS Setup.
3. Select the optical drive as the first boot priority to boot from the support CD. Save your changes, then exit the BIOS Setup.
4. Restart the computer.
5. The Makedisk menu appears. Select **Promise SW ROMB Controller Driver**, and press <Enter> to enter the submenu.

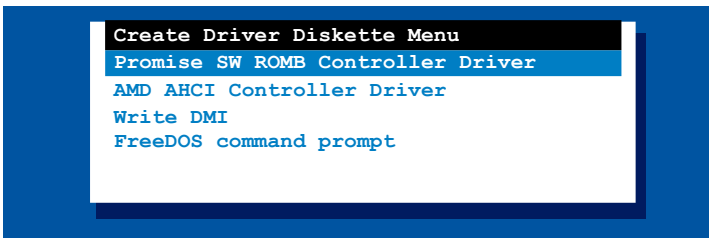

6. Use the arrow keys to select the type of RAID driver disk you want to create.

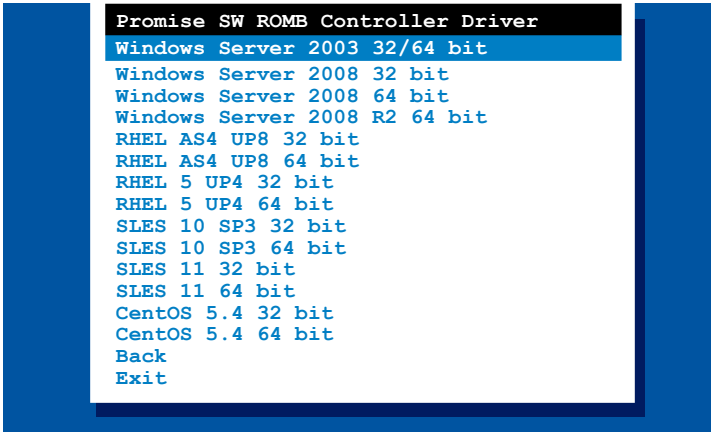

7. Place a blank, high-density floppy disk to the floppy disk drive.
8. Press <Enter>.
9. Follow screen instructions to create the driver disk.

6.1.2 Installing the RAID controller driver

Windows® Server OS

During Windows® Server OS installation

To install the RAID controller driver when installing Windows® Server OS:

1. Boot the computer using the Windows® Server installation DVD. The Windows® Server OS Setup starts.

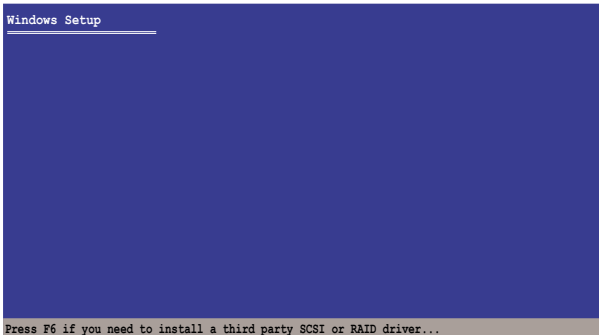

2. Press <F6> when the message “Press F6 if you need to install a third party SCSI or RAID driver...” appears at the bottom of the screen.
3. When prompted, press <S> to specify an additional device.



4. Insert the RAID driver disk you created earlier to the floppy disk drive, then press <Enter>.

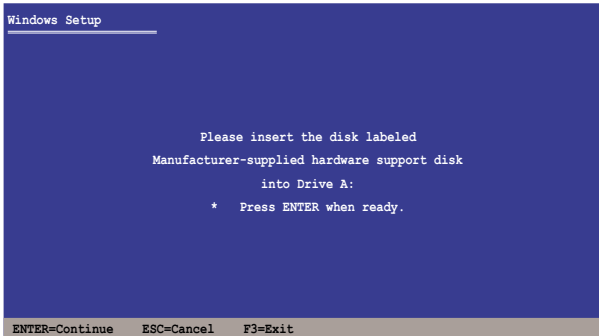

5. Select the RAID controller driver you need from the list, then press <Enter>.
6. The Windows® Setup loads the RAID controller drivers from the RAID driver disk. When prompted, press <Enter> to continue installation.
7. Setup then proceeds with the OS installation. Follow screen instructions to continue.

To an existing Windows® Server OS

To install the RAID controller driver on an existing Windows® Server OS

1. Restart the computer, and then log in with **Administrator** privileges.
2. Windows® automatically detects the RAID controller and displays a **New Hardware Found** window. Click **Cancel**.
3. Right-click the **My Computer** icon on the Windows® desktop, and then select **Properties** from the menu.
4. Click the **Hardware** tab, and then click the **Device Manager** button to display the list of devices installed in the system.
5. Right-click the **RAID controller** item, then select **Properties**.
6. Click the **Driver** tab, and then click the **Update Driver** button.
7. The **Upgrade Device Driver Wizard** window appears. Click **Next**.
8. Insert the RAID driver disk you created earlier to the floppy disk drive.
9. Select the option **Install the software automatically (Recommended)**, and then click **Next**.
10. The wizard searches the RAID controller drivers. When found, click **Next** to install the drivers.
11. Click **Finish** after the driver installation is done.

To verify the RAID controller driver installation:

1. Right-click the **My Computer** icon on the Windows® desktop, and then select **Properties** from the menu.
2. Click the **Hardware** tab, and then click the **Device Manager** button.
3. Click the “+” sign before the item **SCSI and RAID controllers**, and then the **Promise AHCI Compatible RAID Controller** item should appear.

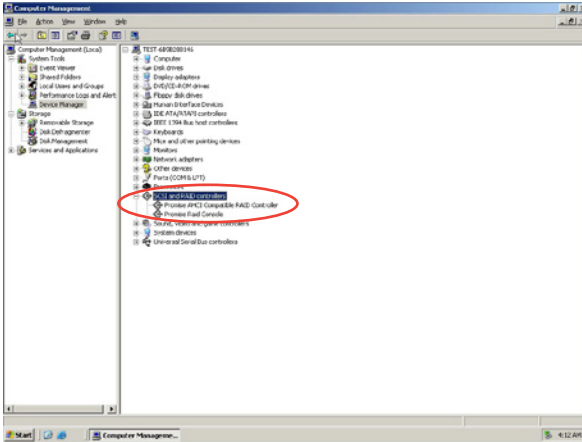

The screen differs based on the controller.

4. Right-click the **RAID controller** driver item, and then select **Properties** from the menu.
5. Click the **Driver** tab, and then click the **Driver Details** button to display the RAID controller drivers.
6. Click **OK** when finished.

Red Hat® Enterprise Linux OS 4.8

To install the RAID controller driver when installing Red Hat® Enterprise OS:

1. Boot the system from the Red Hat® OS installation CD.
2. At the `boot:`, type `linux dd`.
3. Press `<Enter>`.

```
- To install or upgrade in graphical mode, press the <ENTER> key.  
- To install or upgrade in text mode, type: linux text <ENTER>.  
- Use the function keys listed below for more information.  
[F1-Main] [F2-Options] [F3-General] [F4-Kernel] [F5-Rescue]  
boot: linux dd
```

4. Select **Yes** using the `<Tab>` key when asked if you have the driver disk, then press `<Enter>`.

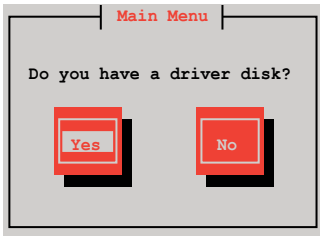

5. Press `<Enter>` to continue.

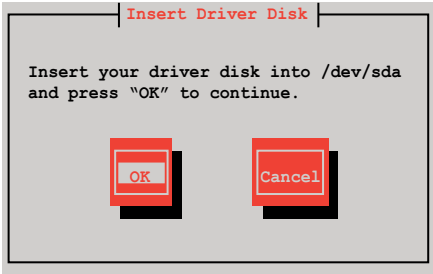

6. Select **No** and press `<Enter>` to continue.

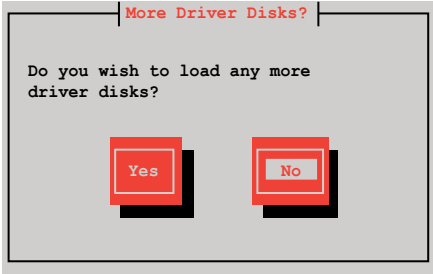

7. Select **Skip** and press <Enter> to continue.

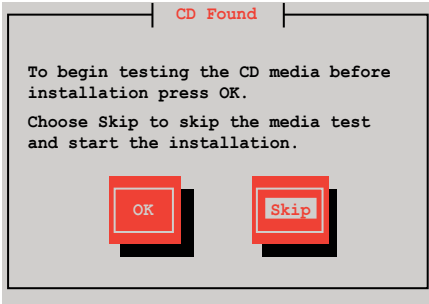

8. Follow the onscreen instructions to finish installing the RedHat operating system.

Red Hat® Enterprise Linux OS 5.0

To install the RAID controller driver when installing Red Hat® Enterprise OS:

1. Boot the system from the Red Hat® OS installation CD.
2. At the `boot:`, type `linux dd`
3. Press <Enter>.

```
- To install or upgrade in graphical mode, press the <ENTER> key.  
- To install or upgrade in text mode, type: linux text <ENTER>.  
- Use the function keys listed below for more information.  
[F1-Main] [F2-Options] [F3-General] [F4-Kernel] [F5-Rescue]  
boot: linux dd
```

4. Select **Yes** using the <Tab> key when asked if you have the driver disk, then press <Enter>.

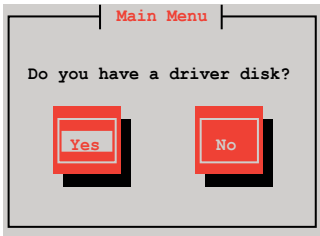

5. Insert the Red Hat® Enterprise RAID driver disk to the floppy disk drive, select **OK**, then press <Enter>.

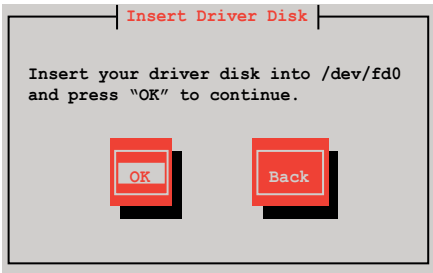

The drivers for the RAID card are installed to the system.

- When asked if you will load additional RAID controller drivers, select **No**, then press <Enter>.

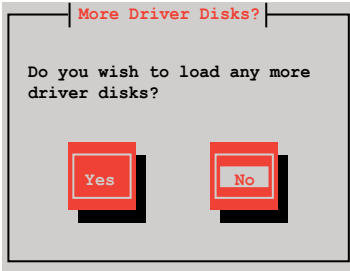

- Follow the onscreen instructions to finish the OS installation.

SUSE Linux 11 OS

To install the RAID controller driver when installing SUSE Linux Enterprise Server OS:

1. Boot the system from the SUSE OS installation CD.
2. Use the arrow keys to select **Installation** from the **Boot Options** menu.

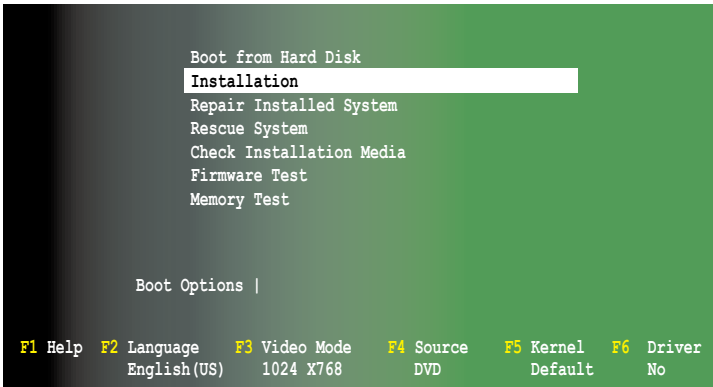

3. Press <F6>, then select **Yes** from the menu. Press <Enter>.

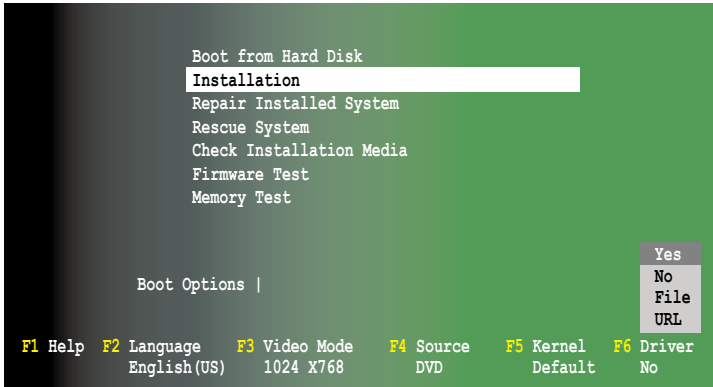

4. Insert the RAID driver disk to the floppy disk drive. Type the command **acpi=off apic=bigsm brokenmodules=ahci** in **Boot Options** field, and press <Enter>.

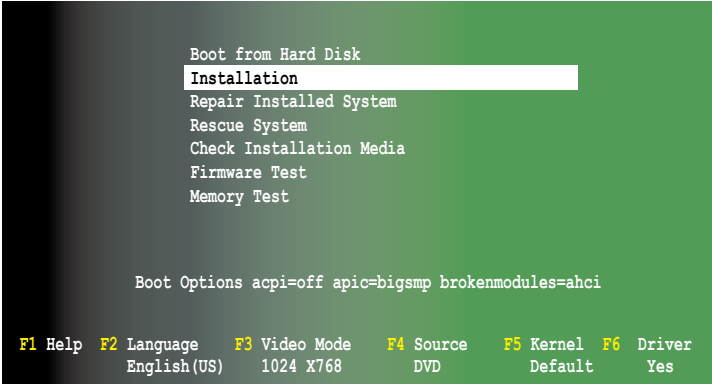

5. When below screen appears, select the USB floppy disk drive (sda) as the driver update medium. Select **OK**, then press <Enter>.

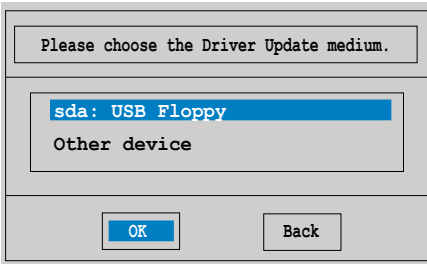

- The drivers for the RAID controller are installed to the system as shown below.

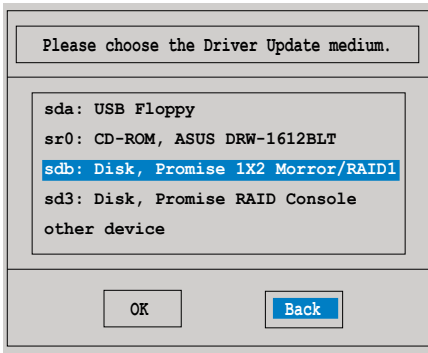

- Select **Back** and follow the onscreen instructions to finish the installation.

6.2 AMD® processor driver installation

This section provides instructions on how to install the AMD® processor driver on the system.

You need to manually install the AMD® processor driver on a Windows XP / Server 2003 operating system.

To install the AMD® processor driver:

1. Restart the computer, then log on with **Administrator** privileges.
2. Insert the motherboard/system support DVD to the optical drive. The support DVD automatically displays the **Drivers** menu if Autorun is enabled in your computer.



If Autorun is NOT enabled in your computer, browse the contents of the support DVD to locate the file **AUTORUN.EXE** and double-click the **AUTORUN.EXE** to run the support DVD.

3. Click the item **AMD Processor Driver** from the menu, and then follow the onscreen instructions to complete the installation.



4. When the **Intel® Network Connections – InstallShield Wizard** window appears, click **Next** to start the installation.



5. Click **I accept the terms in the license agreement** and then click **Next** to continue.

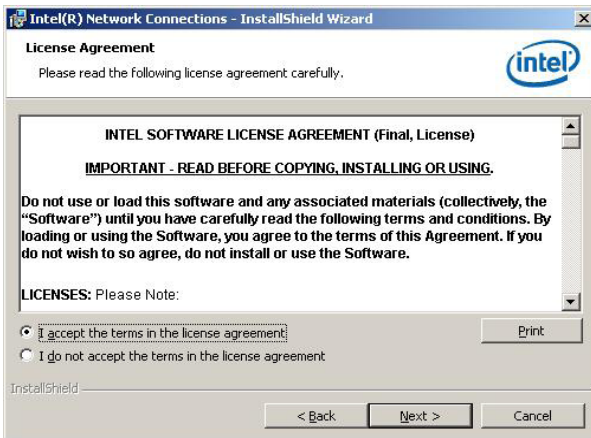

6. Select the programs you want to install and click **Next** to continue.

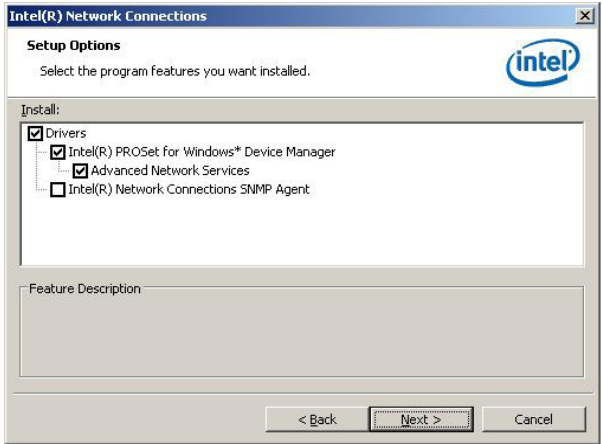

7. Click **Install** to start the installation.

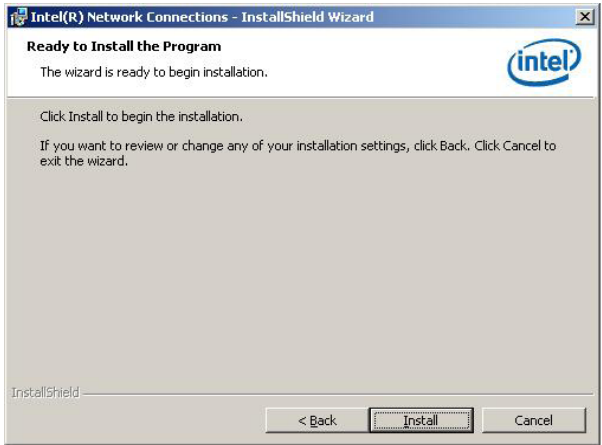

- The programs you select are being installed.

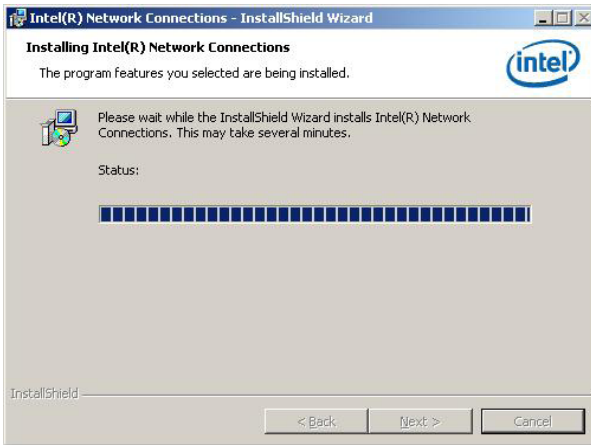

- Click **Finish** to finish the installation.

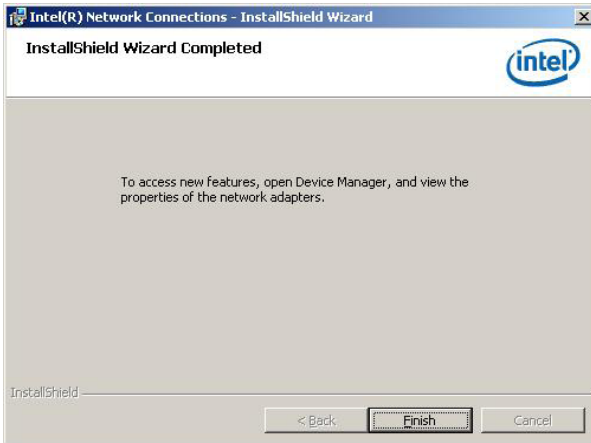

6.4 ATI SM Bus controller driver installation

This section provides instructions on how to install the ATI SM Bus driver on the system.

You need to manually install the ATI SMBus driver on a Windows® XP / Server 2003 operating system. To install the driver:

1. Restart the computer, then log on with **Administrator** privileges.
2. Insert the motherboard/system support DVD to the optical drive. The support DVD automatically displays the **Drivers** menu if Autorun is enabled in your computer.



If Autorun is NOT enabled in your computer, browse the contents of the support DVD to locate the file **AUTORUN.EXE** and double-click the **AUTORUN.EXE** to run the support DVD.

3. Click the item **ATI SM Bus Controller Driver** from the menu, and then follow the onscreen instructions to complete the installation.



6.5 Display driver installation

This section provides instructions on how to install the ASPEED display driver.

To install the ASPEED display driver on a Windows® OS:

1. Restart the computer, then log on with Administrator privileges.
2. Insert the motherboard/system support DVD to the optical drive. The support DVD automatically displays the Drivers menu if Autorun is enabled in your computer.



If Autorun is NOT enabled in your computer, browse the contents of the support DVD to locate the file **AUTORUN.EXE** and double-click the **AUTORUN.EXE** to run the support DVD.

3. Click **ASPEED AST2050 Display Driver**.



4. When the **ASPEED InstallShield Wizard** window appears, click **Next** to continue.

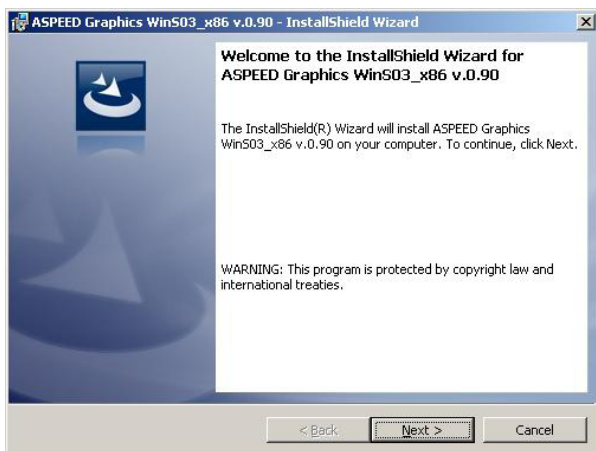

5. Click **Install** to start the installation.

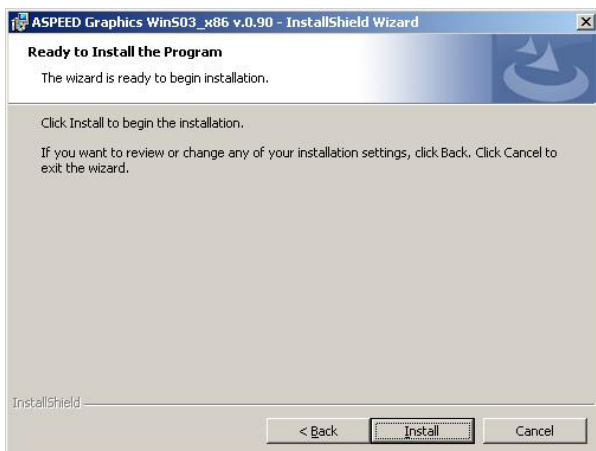

6. The system installs the driver automatically.

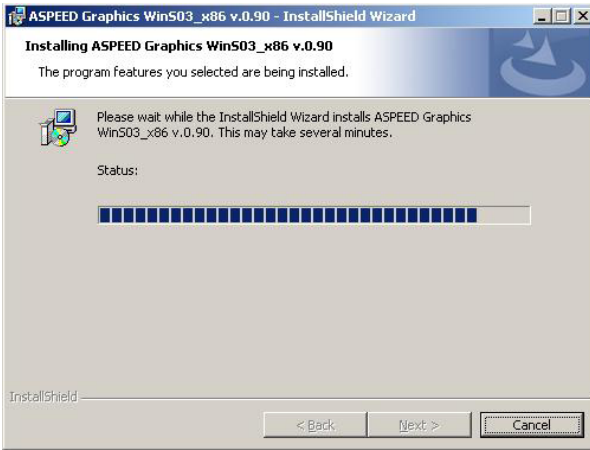

7. When the installation completes, click **Finish** to exit the wizard.



6.6 Management applications and utilities installation

The support DVD that came with the motherboard package contains the drivers, management applications, and utilities that you can install to avail all motherboard features.



The contents of the support DVD are subject to change at any time without notice. Visit the ASUS website (www.asus.com) for updates.

6.6.1 Running the support DVD

Place the support DVD to the optical drive. The DVD automatically displays the Drivers menu if Autorun is enabled in your computer.



If Autorun is NOT enabled in your computer, browse the contents of the support DVD to locate the file **ASSETUP.EXE** from the BIN folder. Double-click the **ASSETUP.EXE** to run the DVD.

6.6.2 Drivers menu

The Drivers menu shows the available device drivers if the system detects installed devices. Install the necessary drivers to activate the devices.



The screen display and driver options vary under different operating system versions.



6.6.3 Utilities menu

The Utilities menu displays the software applications and utilities that the motherboard supports. Click an item to install.



6.6.4 Make disk menu

The Make disk menu contains items to create the RAID driver disk.



6.6.5 Contact information

Click the Contact tab to display the ASUS contact information. You can also find this information on the inside front cover of this user guide.

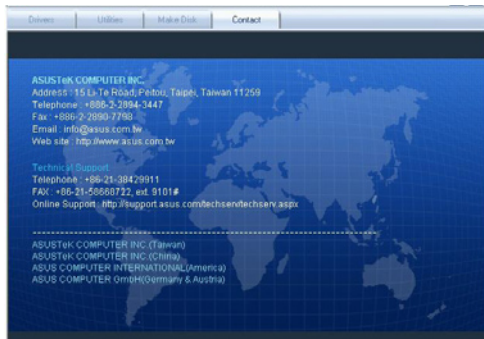

Appendix summary



A.1 KGPE-D16 block diagram A-3

A.1 KGPE-D16 block diagram

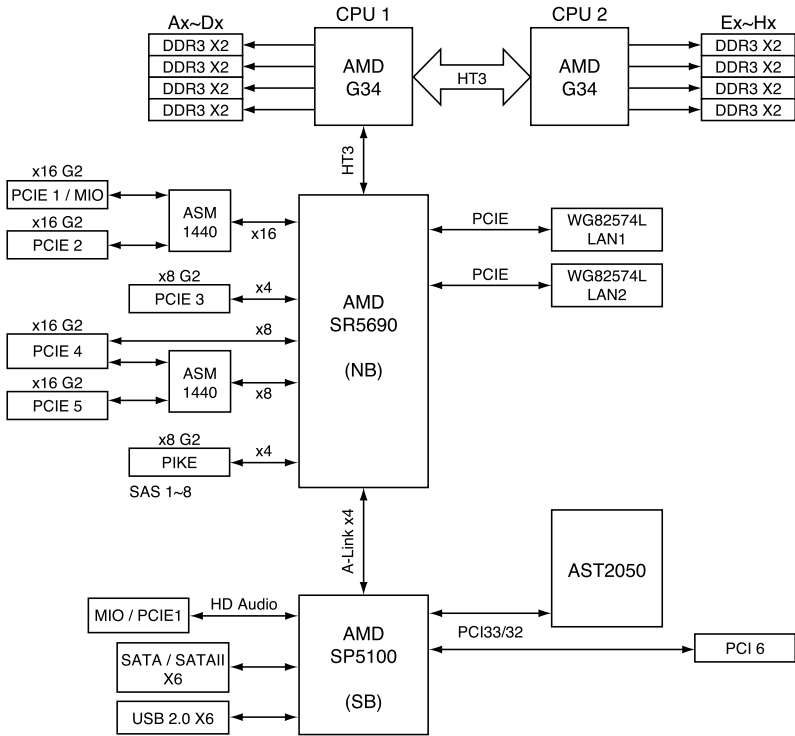

ASUS contact information

ASUSTeK COMPUTER INC.

Address 15 Li-Te Road, Peitou, Taipei, Taiwan 11259
Telephone +886-2-2894-3447
Fax +886-2-2890-7798
E-mail info@asus.com.tw
Web site <http://www.asus.com.tw>

Technical Support

Telephone +86-21-38429911
Fax +86-21-58668722 ext: 9101
Online Support <http://support.asus.com/techserv/techserv.aspx>

ASUSTeK COMPUTER INC. (Taiwan)

Address 15 Li-Te Road, Peitou, Taipei, Taiwan 11259
Telephone +886-2-2894-3447
Fax +886-2-2890-7798
E-mail info@asus.com.tw
Web site <http://www.asus.com.tw>

Technical Support

Telephone +886-2-2894-3447 (0800-093-456)
Online Support <http://support.asus.com/techserv/techserv.aspx>

ASUSTeK COMPUTER INC. (China)

Address No.508, Chundong Road, Xinzhuang Industrial Zone,
Minhang District, Shanghai, China.
Telephone +86-21-5442-1616
Fax +86-21-5442-0099
Web site <http://www.asus.com.cn>

Technical Support

Telephone 400-620-6655
Online Support <http://www.asus.com.cn>

ASUS contact information

ASUS COMPUTER INTERNATIONAL (America)

Address 800 Corporate Way, Fremont, CA 94539, USA
Fax +1-510-608-4555
Web site <http://usa.asus.com>

Technical Support

Support fax +1-812-284-0883
General support +1-812-282-2787
Online support <http://support.asus.com/techserv/techserv.aspx>

ASUS COMPUTER GmbH (Germany and Austria)

Address Harkort Str. 21-23, D-40880 Ratingen, Germany
Fax +49-2102-959911
Web site <http://www.asus.de>
Online contact <http://www.asus.de/sales>

Technical Support

Telephone +49-1805-010923
Support Fax +49-2102-959911
Online support <http://support.asus.com/techserv/techserv.aspx>

ASUS Czech Service s.r.o. (Europe)

Address Na Rovince 887, 720 00 Ostrava – Hrabová, Czech Republic
Telephone +420-596766888
Web site <http://www.asus.cz>

Technical Support

Telephone +420-596-766-891
Fax +420-596-766-329
E-mail advance.rma.eu@asus.com
Online Support <http://support.asus.com/techserv/techserv.aspx>

ASUS contact information

ASUS Holland BV (The Netherlands)

Address Marconistraat 2, 7825GD EMMEN, The Netherlands
Web site <http://www.asus.com>

Technical Support

Telephone +31-(0)591-5-70292
Fax +31-(0)591-666853
E-mail advance.rma.eu@asus.com
Online Support <http://support.asus.com/techserv/techserv.aspx>

ASUS Polska Sp. z o.o. (Poland)

Address Ul. Postępu 6, 02-676 Warszawa, Poland
Web site <http://pl.asus.com>

Technical Support

Telephone +48-225718033
Online Support <http://support.asus.com/techserv/techserv.aspx>

ASK-Service (Russia and CIS)

Address г. Москва, ул. Орджоникидзе, д.10, Россия
Telephone (495) 640-32-75
Web site <http://ru.asus.com>

Technical Support

Telephone 008-800-100-ASUS (008-800-100-2787)
Online Support <http://vip.asus.com/eservice/techserv.aspx?SLanguage=ru>

DECLARATION OF CONFORMITY

Per FCC Part 2, Section 2.1077(a)



Responsible Party Name: **Asus Computer International**

Address: **800 Corporate Way, Fremont, CA 94539.**

Phone/Fax No: **(510)739-3777/(510)608-4555**

hereby declares that the product

Product Name : Motherboard

Model Number : KGPE-D16

Conforms to the following specifications:

- FCC Part 15, Subpart B, Unintentional Radiators
- FCC Part 15, Subpart C, Intentional Radiators
- FCC Part 15, Subpart E, Intentional Radiators

Supplementary Information:

This device complies with part 15 of the FCC Rules. Operation is subject to the following two conditions: (1) This device may not cause harmful interference, and (2) this device must accept any interference received, including interference that may cause undesired operation.

Representative Person's Name : Steve Chang / President

Signature : *Steve Chang*
Date : Mar. 26, 2010

EC Declaration of Conformity



We, the undersigned,

Manufacturer: **ASUSTEK COMPUTER INC.**
4F, No. 150, LI-TE Rd., PEITOU, TAIPEI 112, TAIWAN
Country: **TAIWAN**
ASUS COMPUTER GmbH
Authorized representative in Europe:
Address: City: **HARKORT STR. 7-23, 40860 RATINGEN**
Country: **GERMANY**

declare the following apparatus:

Product name : **Motherboard**
Model name : **KGPE-D16**

conform with the essential requirements of the following directives:

2004/108/EC EMC Directive
 EN 55022:2010
 EN 61000-3-2:2006+A2:2009
 EN 55032:2007+A1:2009+A2:2006
 1989/5/EEC R & TTE Directive
 EN 300 328 V1.7.1 (2006-10)

EN 300 442 V1.4.1 (2010-08)
 EN 301 875 V1.0.2 (2003-03)
 EN 301 875 V1.1.1 (2005-11)
 EN 301 875 V1.2 (2006-07)
 EN 301 875 V1.3 (2005-11)
 EN 301 875 V1.4 (2006-08)
 EN 301 875 V1.5 (2006-08)
 EN 301 875 V1.6 (2011-11)
 EN 301 883 V1.6.1 (2011-11)
 EN 302 552 V1.1 (2009-01)
 EN 302 552 V1.2 (2007-06)
 EN 300 335-1 V1.7.1 (2010-02)
 EN 300 335-2 V1.5.1 (2010-02)
 EN 62479:2010
 EN 301 489-1 V1.9.2 (2011-09)
 EN 301 489-2 V1.9.2 (2011-09)
 EN 301 489-3 V1.9.2 (2011-09)
 EN 301 489-4 V1.4.1 (2006-05)
 EN 301 489-7 V1.3.1 (2005-11)
 EN 301 489-7 V1.3.2 (2005-11)
 EN 301 489-7 V1.4.1 (2006-05)
 EN 301 489-7 V2.1 (2006-05)
 EN 301 489-24 V1.6.1 (2010-09)
 EN 301 489-24 V1.6.2 (2010-09)
 EN 302 366-2 V1.2 (2007-06)
 EN 302 366-2 V1.3 (2007-06)
 EN 301 357-2 V1.4.1 (2008-11)
 EN 50365:2002
 EN 62311:2008

2006/95/EC LVD Directive
 EN 60950-1 /A11:2009
 EN 60950-1 /A12:2011

2009/125/EC EIP Directive
 Regulation (EC) No. 1275/2008
 Regulation (EC) No. 642/2009

2011/65/EU RoHS Directive
 CE marking

Ver. 12/01



(EC conformity marking)

Position : **CEO**
Name : **Jerry Shen**

Jerry Shen

Signature : _____

Declaration Date: **Jan. 25, 2013**
Year to begin affixing CE marking: **2013**