

General Description

This planar stripe MOSFET has better characteristics, such as fast switching time, low on resistance, low gate charge and excellent avalanche characteristics. It is mainly suitable for switching mode power supplies.

FEATURES

- $V_{DSS(Min.)} = 600V$, $I_D = 4.5A$
- Drain-Source ON Resistance :
 $R_{DS(ON)} = 2.5 \Omega @ V_{GS} = 10V$
- $Q_g(typ.) = 17nC$

MAXIMUM RATING (Tc=25°C)

CHARACTERISTIC	SYMBOL	RATING		UNIT
		KHB4D5N60P	KHB4D5N60F KHB4D5N60F2	
Drain-Source Voltage	V_{DSS}	600		V
Gate-Source Voltage	V_{GSS}	± 30		V
Drain Current	@Tc=25°C	4.5	4.5*	A
	@Tc=100°C	2.8	2.8*	
	Pulsed (Note1)	I_{DP}	18	
Single Pulsed Avalanche Energy (Note 2)	E_{AS}	260		mJ
Repetitive Avalanche Energy (Note 1)	E_{AR}	10.6		mJ
Peak Diode Recovery dv/dt (Note 3)	dv/dt	4.5		V/ns
Drain Power Dissipation	Tc=25°C	106	36	W
	Derate above 25°C	P_D	0.85	0.29
Maximum Junction Temperature	T_j	150		°C
Storage Temperature Range	T_{stg}	-55~150		°C
Thermal Characteristics				
Thermal Resistance, Junction-to-Case	R_{thJC}	1.18	3.47	°C/W
Thermal Resistance, Case-to-Sink	R_{thCS}	0.5	-	°C/W
Thermal Resistance, Junction-to-Ambient	R_{thJA}	62.5	62.5	°C/W

* : Drain current limited by maximum junction temperature.

PIN CONNECTION

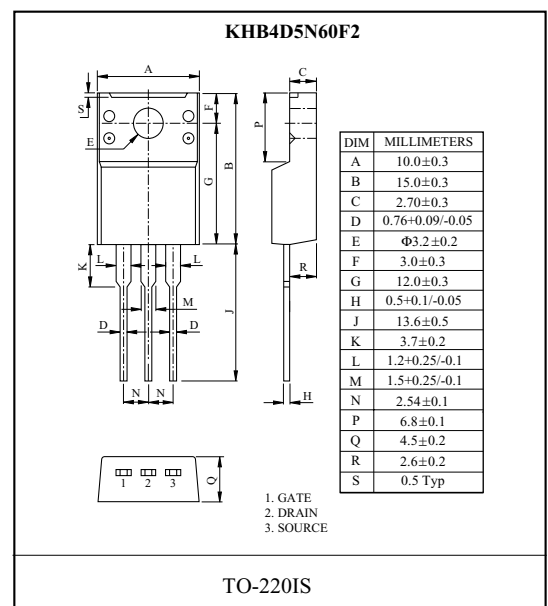
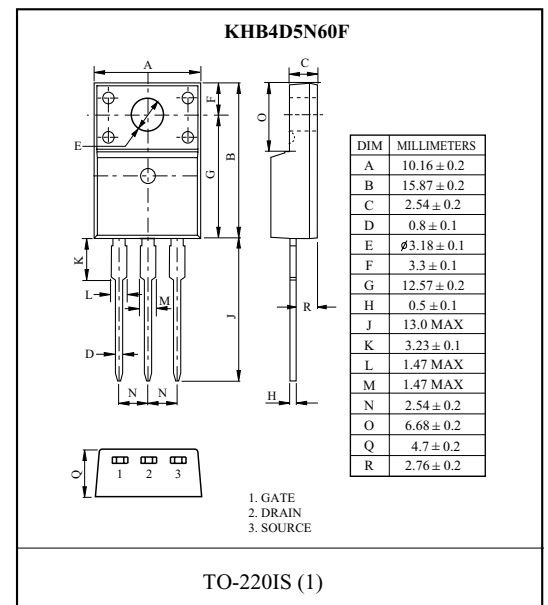
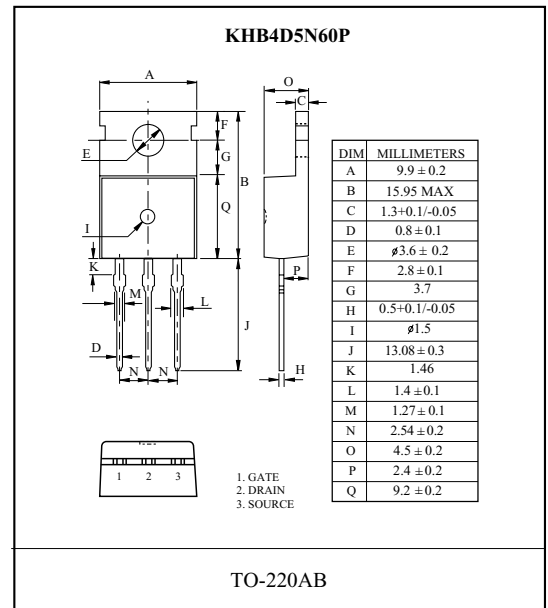
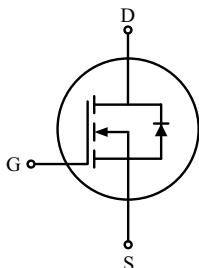

KHB4D5N60P/F/F2

ELECTRICAL CHARACTERISTICS (Tc=25 °C)

CHARACTERISTIC	SYMBOL	TEST CONDITION	MIN.	TYP.	MAX.	UNIT
Static						
Drain-Source Breakdown Voltage	BV _{DSS}	I _D =250μA, V _{GS} =0V	600	-	-	V
Breakdown Voltage Temperature Coefficient	ΔBV _{DSS} /ΔT _j	I _D =250μA, Referenced to 25 °C	-	0.6	-	V/°C
Drain Cut-off Current	I _{DSS}	V _{DS} =600V, V _{GS} =0V,	-	-	±10	μA
Gate Threshold Voltage	V _{th}	V _{DS} =V _{GS} , I _D =250μA	2	-	4	V
Gate Leakage Current	I _{GSS}	V _{GS} =±30V, V _{DS} =0V	-	-	±100	nA
Drain-Source ON Resistance	R _{DS(ON)}	V _{GS} =10V, I _D =2.25A	-	2.2	2.5	Ω
Dynamic						
Total Gate Charge	Q _g	V _{DS} =480V, I _D =4.5A V _{GS} =10V (Note4,5)	-	17	21	nC
Gate-Source Charge	Q _{gs}		-	3	-	
Gate-Drain Charge	Q _{gd}		-	7.3	-	
Turn-on Delay time	t _{d(on)}	V _{DD} =300V R _L =67 Ω R _G =25 Ω (Note4,5)	-	15	35	ns
Turn-on Rise time	t _r		-	35	80	
Turn-off Delay time	t _{d(off)}		-	70	150	
Turn-off Fall time	t _f		-	80	170	
Input Capacitance	C _{iss}	V _{DS} =25V, V _{GS} =0V, f=1.0MHz	-	655	850	pF
Output Capacitance	C _{oss}		-	66	86	
Reverse Transfer Capacitance	C _{rss}		-	8	11	
Source-Drain Diode Ratings						
Continuous Source Current	I _S	V _{GS} <V _{th}	-	-	4.5	A
Pulsed Source Current	I _{SP}		-	-	18	
Diode Forward Voltage	V _{SD}	I _S =4.5A, V _{GS} =0V	-	-	1.5	V
Reverse Recovery Time	t _{rr}	I _S =4.5A, V _{GS} =0V, dI _S /dt=100A/μs	-	350	-	ns
Reverse Recovery Charge	Q _{rr}		-	2.7	-	μC

Note 1) Repetivity rating : Pulse width limited by junction temperature.

Note 2) L = 25mH, I_S=4.5A, V_{DD}=50V, R_G = 25 Ω, Starting T_j = 25 °C.

Note 3) I_S ≤ 4.5A, dI/dt ≤ 200A/μs, V_{DD} ≤ BV_{DSS}, Starting T_j = 25 °C.

Note 4) Pulse Test : Pulse width ≤ 300μs, Duty Cycle ≤ 2%.

Note 5) Essentially independent of operating temperature.

KHB4D5N60P/F/F2

Fig1. $I_D - V_{DS}$

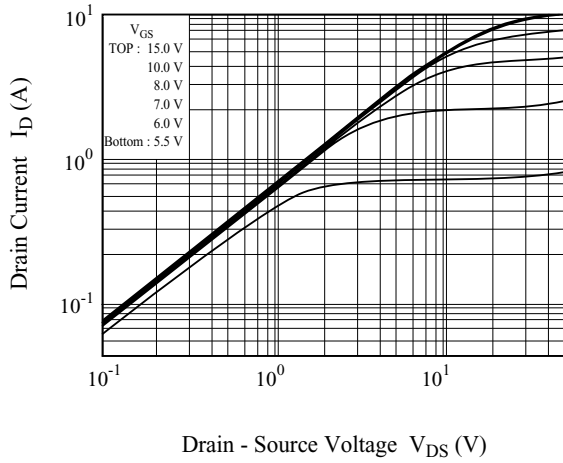

Fig2. $I_D - V_{GS}$

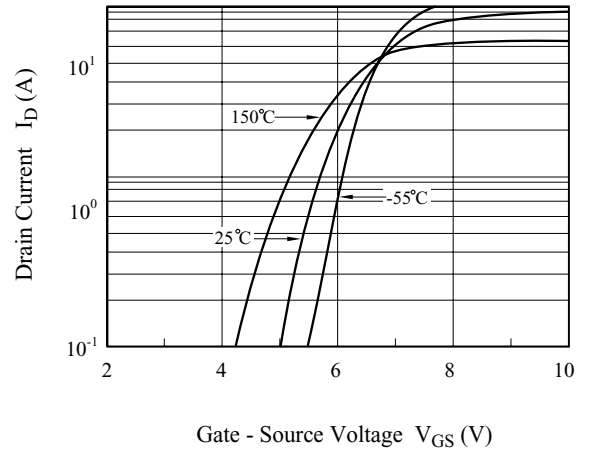

Fig3. $BV_{DSS} - T_j$

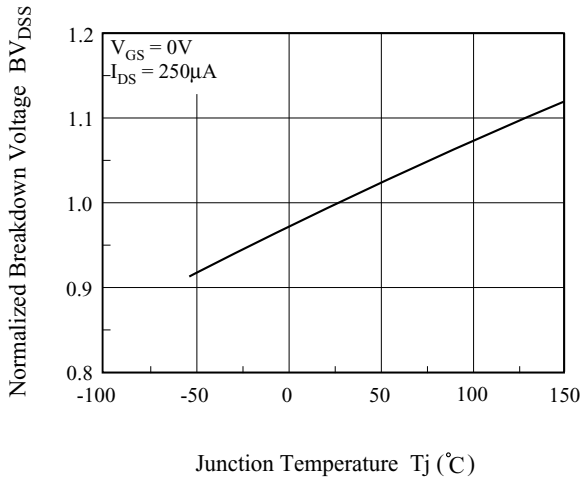

Fig4. $R_{DS(ON)} - I_D$

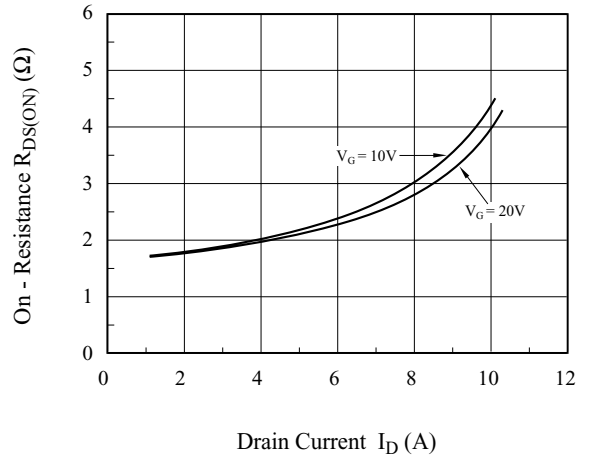

Fig5. $I_S - V_{SD}$

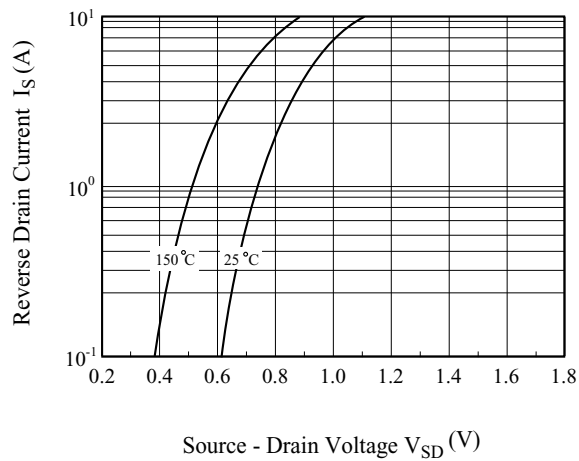
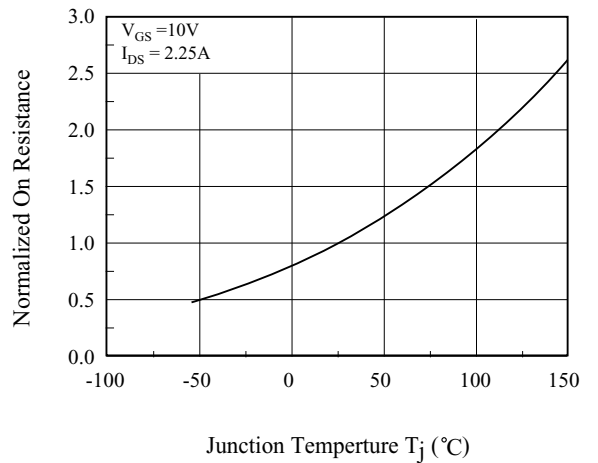

Fig6. $R_{DS(ON)} - T_j$



KHB4D5N60P/F/F2

Fig7. C - V_{DS}

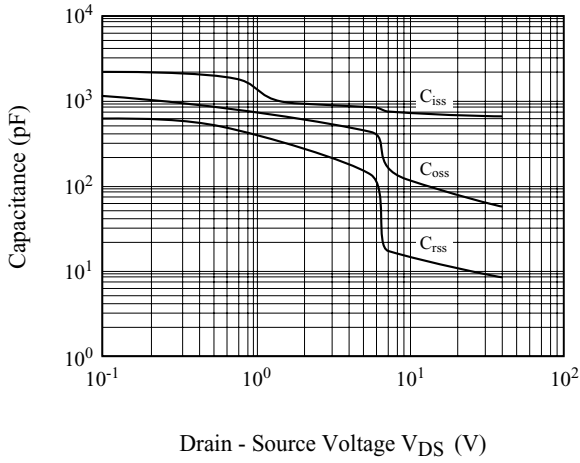

Fig8. Q_g- V_{GS}

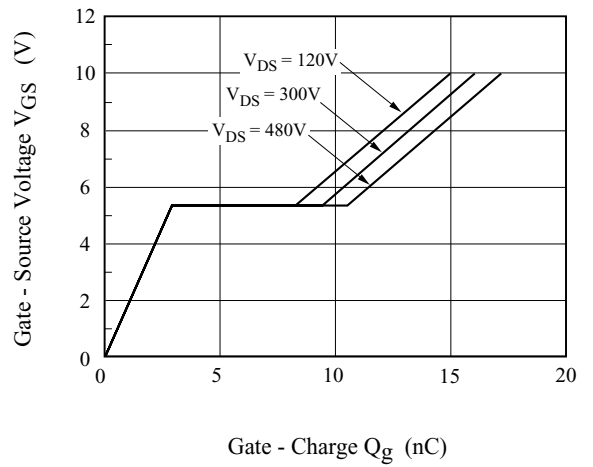

Fig9. Safe Operation Area

(KHB4D5N60P)

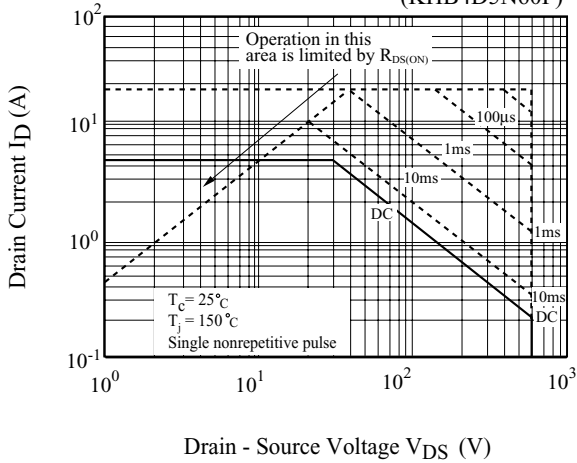

Fig10. Safe Operation Area

(KHB4D5N60F, KHB4D5N60F2)

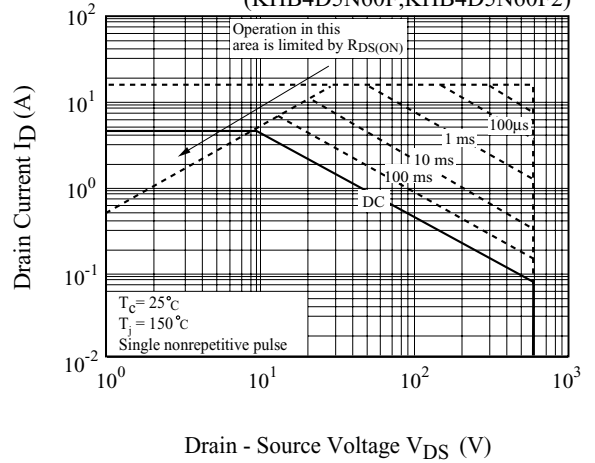

Fig11. I_D - T_j

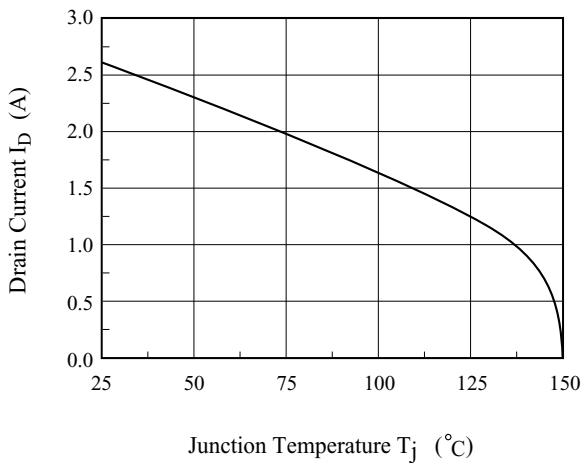

Fig12. Transient Thermal Response Curve

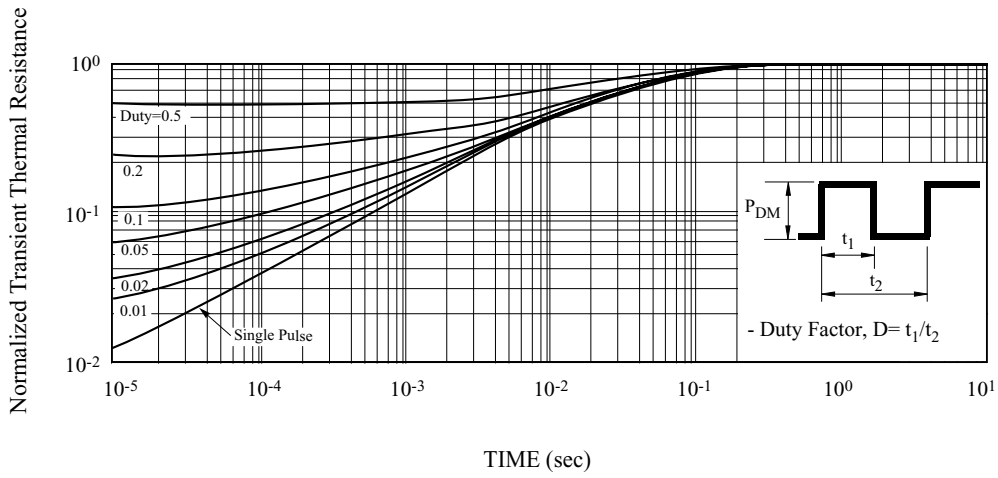
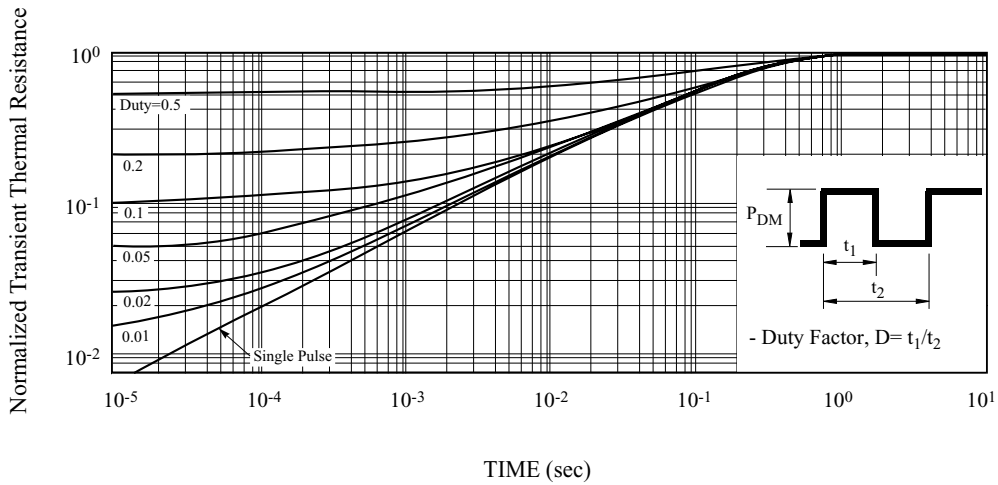

Fig13. Transient Thermal Response Curve



KHB4D5N60P/F/F2

Fig14. Gate Charge

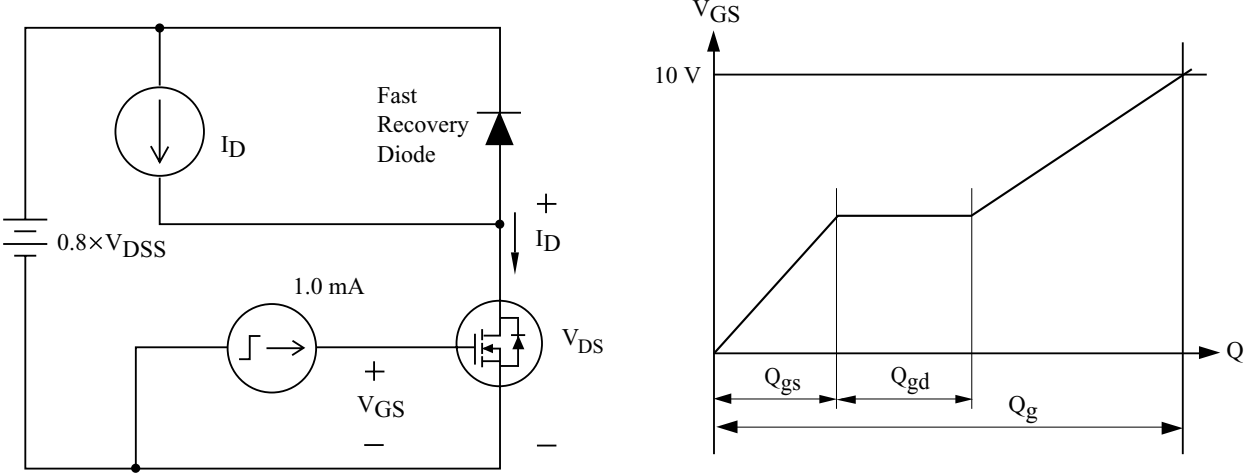
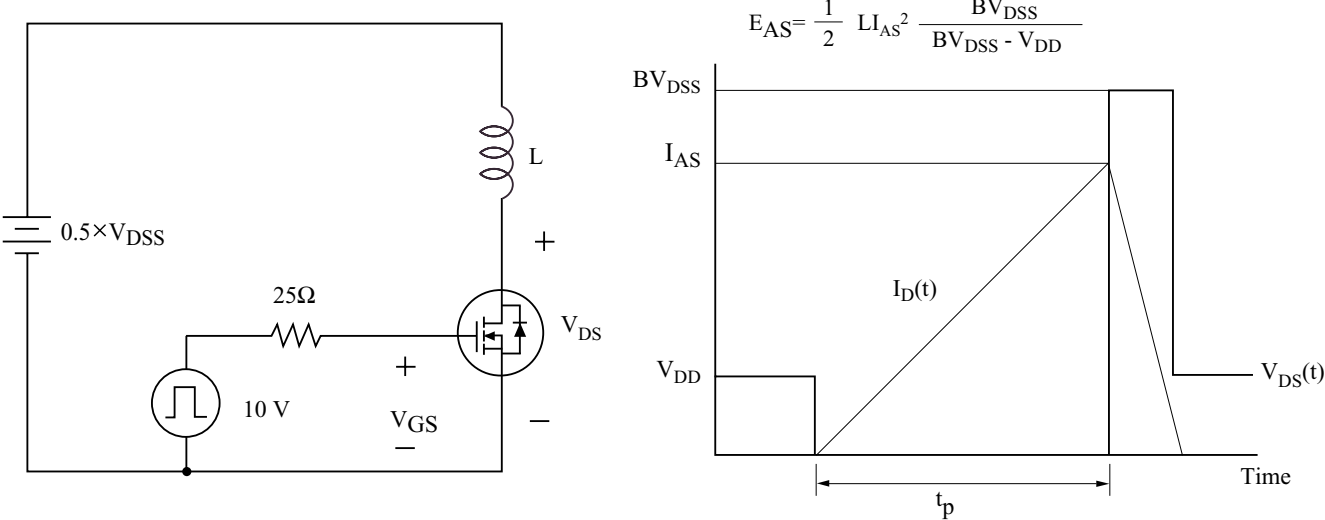

Fig15. Single Pulsed Avalanche Energy



KHB4D5N60P/F/F2

Fig16. Resistive Load Switching

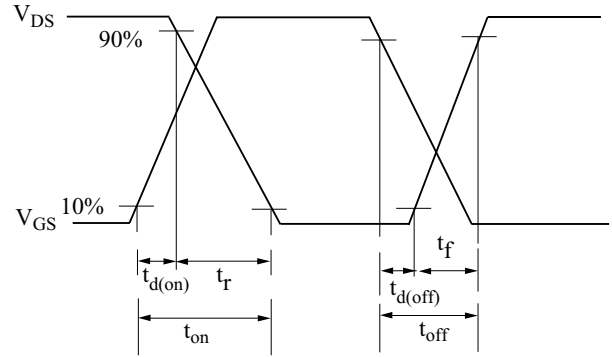
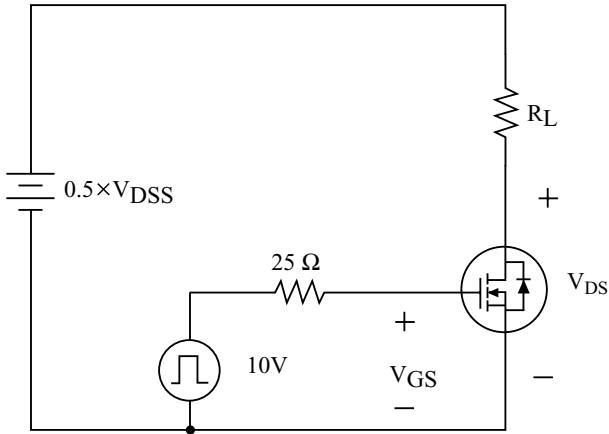

Fig17. Source - Drain Diode Reverse Recovery and dv/dt

