

Ripple Filter for 1.5V Headphone Stereo

The KIA2015FN is a ripple filter IC, which is developed for low voltage operation.(1.5V). It is especially suitable for supplying voltage for headphone stereo etc.

FUNCTIONS

- Built-in power switch
- Excellent ripple rejection ratio : RR=43dB(Typ.)
- Ripple filter output voltage can be controlled by external resistor.
- Output voltage is limited to V_{RF}=1.5V(Typ.)
- Built-in two constant current sources.
- Excellent low voltage operation.
- Low quiescent supply current (V_{CC}=1.2V, T_a=25°C)
: I_{CC}=0.7mA(Typ.)
- Operating supply voltage range : V_{CC(opr)}=0.9~2.2V.

MAXIMUM RATINGS (T_a=25°C)

CHARACTERISTIC	SYMBOL	RATING	UNIT
Supply Voltage	V _{CC}	4.5	V
Constant Current Source Output Voltage	V _S	4.5	
Constant Current Source Output Current	I _S	10	mW
Ripple Filter Output Current (Built-in transistor)	I _{RF}	20	
Power Dissipation	P _D (Note)	300	mW
Operating Temperature	T _{opr}	-25~75	°C
Storage Temperature	T _{stg}	-55~150	

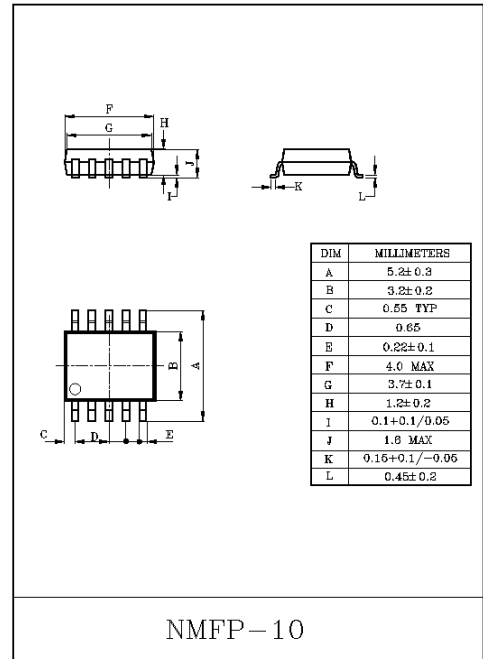

BLOCK DIAGRAM

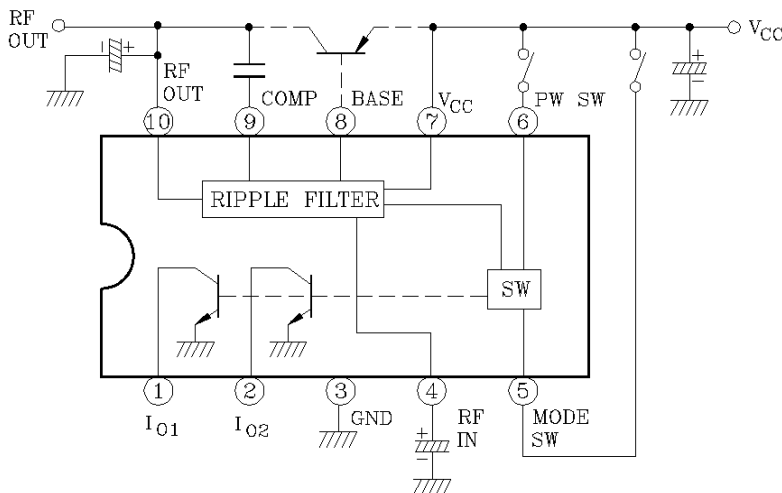

KIA2015FN

ELECTRICAL CHARACTERISTICS

(Unless otherwise specified, $V_{CC}=1.2V$, $T_a=25^{\circ}C$, $SW_1=ON$, $SW_2=OFF$)

CHARACTERISTIC	SYMBOL	TEST CIRCUIT	TEST CONDITION	MIN.	TYP.	MAX.	UNIT	
Quiescent Current	I_{CC1}	-	PW OFF, $SW_1:OPEN$ $SW_2:OPEN$	-	0.1	5	μA	
	I_{CC2}	-	$SW_2:OPEN$, $I_{O1}=I_{O2}=0$	-	0.5	0.8	mA	
	I_{CC3}	-	$I_{RF}=I_{O2}=0$	-	0.7	1.0		
Ripple Filter Output Voltage	V_{RF}	-	$V_{CC}=1V$, $I_{RF}=0$	0.91	0.94	-	V	
Ripple Rejection Ratio	RR	-	$V_r=-32dBV$, $f=100Hz$, $I_{RF}=30mA$	36	43	-	dB	
Constant Current Source Output Current	I_{O1}	-	$SW_2:OPEN$	50	-	-	μA	
	I_{O2}	-	-	50	-	-		
Power Switch ON Current	I_6	-	$V_{CC}=0.9V$	$V_{I0} \geq 0.6V$	5	-	μA	
Power Switch OFF Voltage	V_6	-		$V_{I0} \leq 0.3V$	0	-	0.3	V
Mode Switch ON Current	I_5	-		$V_{I0} \geq 0.6V$	5	-	-	μA
Mode Switch OFF Voltage	V_5	-		$V_{I0} \leq 0.3V$	0	-	0.3	V

TEST CIRCUIT

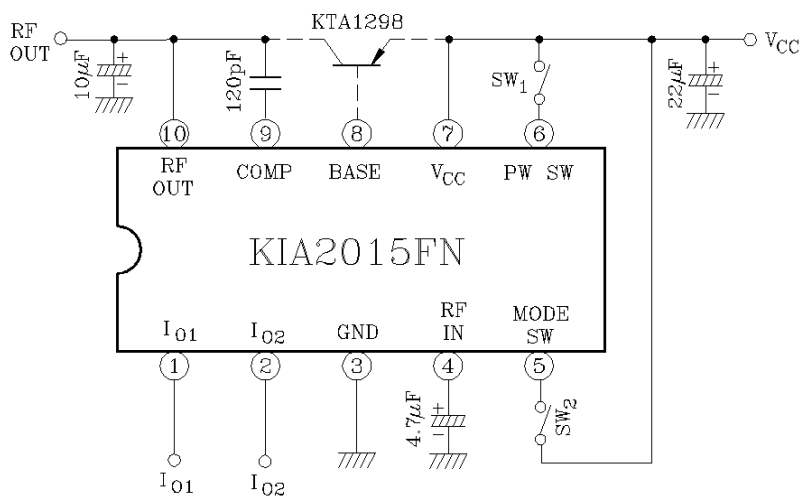

KIA2015FN

EXPLANATION OF TERMINAL

Terminal Voltage : Typical terminal voltage with test circuit ($V_{CC}=1.2V$, $T_a=25^{\circ}C$, non Load)

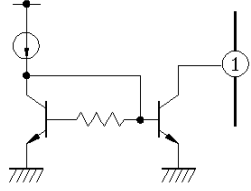
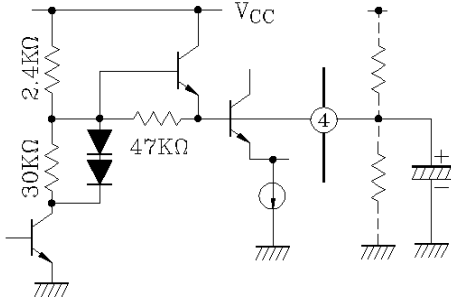
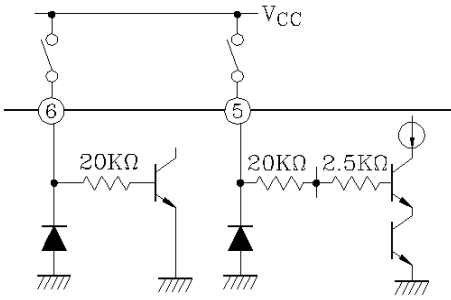
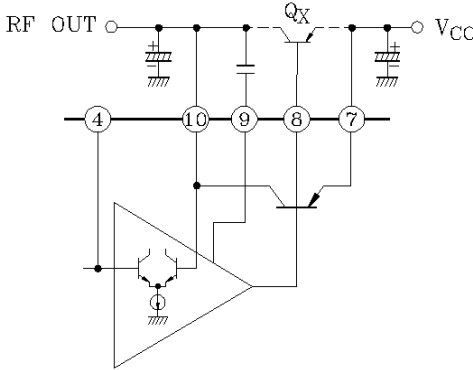
TERMINAL		FUNCTION	INTERNAL CIRCUIT	TERMINAL VOLTAGE(V)
No.	NAME			
1	IO ₁	Output of constant current source 1 Operating Condition • PW SW : H • MODE SW : L		-
2	IO ₂	Output of constant current source 2 Synchronized to PW SW		-
3	GND	-	-	0
4	RF IN	Ripple filter terminal Ripple filter output voltage can be controlled by external resistor. (See application note)		1
5	MODE SW	Mode Switch • V _{CC} : IO ₂ , RF OUT on • GND/OPEN : IO ₁ , IO ₂ on		-
6	PW SW	Power Switch • V _{CC} : Power on • GND/OPEN : Power off		-
7	V _{CC}	-	-	1.2
8	BASE	Base biasing terminal for ripple filter transistor. Output current capacity is 1.2mA with only built-in PNP transistor. This capacity can be increased with an external transistor Q _x .		0.5
9	COMP	Phase compensation terminal for a ripple filter circuit.		0.5
10	RF OUT	Ripple filter output.		1.14

APPLICATION NOTE

1. Operation mode of constant current source

Operation mode is decided by switch condition shown in table 1.
Output of constant current source 1 can be used as a reset circuit by changing start up timing of PW SW, MODE SW.

		MODE SW	
		H	L
PW SW	H	I_{O2} RF OUT	I_{O1} I_{O2}
	L	-	-

Table.1 Operation mode

2. Ripple filter output

It is necessary to connect an external pull-down resistor with PW SW (pin⑥) and MODE SW (pin⑤) in case that ripple filter circuit doesn't operated normally due to external noise etc.

3. Adjustment of ripple filter output voltage.

Internal circuit of pin ④ is shown in Fig.1 Ripple filter output voltage is decided by internal resistor R1, R2 and Q3, and limited by D_{1-2} and Q_3 to $V_{RF}=1.5V$ (Typ.)

Ripple filter output voltage can be controlled by method below.

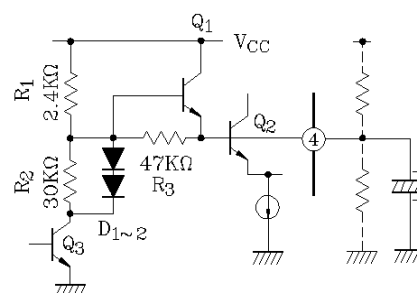

Fig. 1 Internal circuit of pin ④

(1) Method to rise the ripple filter output voltage

External resistor should be connected between V_{CC} and RF IN terminal (pin ④). In this case, output current capacity of ripple filter circuit is down. Because at ripple filter output stage, collector-emitter voltage of PNP transistor will small, and drive capacity of transistor is down.

(2) Method to rise the ripple filter output voltage

External resistor should be connected between GND and RF IN terminal (pin④). Current flows through external resistor and internal resistor R1, R3(2.4kΩ, 47kΩ). In case that output voltage dropped too much, ripple rejection ratio and other characteristics will be worse, because constant current source of differential amplifier is saturated especially at low voltage.

KIA2015FN

CHARACTERISTIC CURVES (Unless otherwise specified, $V_{CC}=1.2V$, $I_{RF}=0$, $I_{O1}=I_{O2}=0$, $T_a=25^\circ C$)

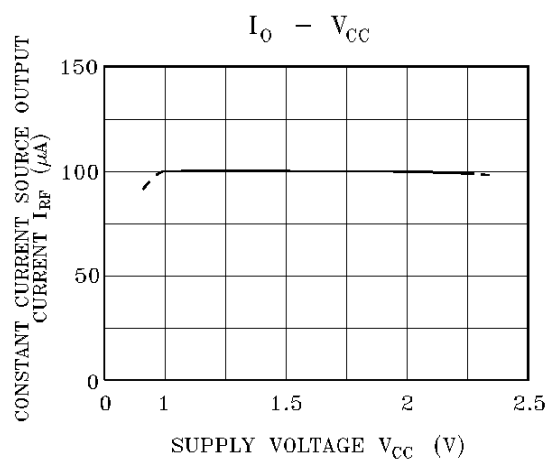
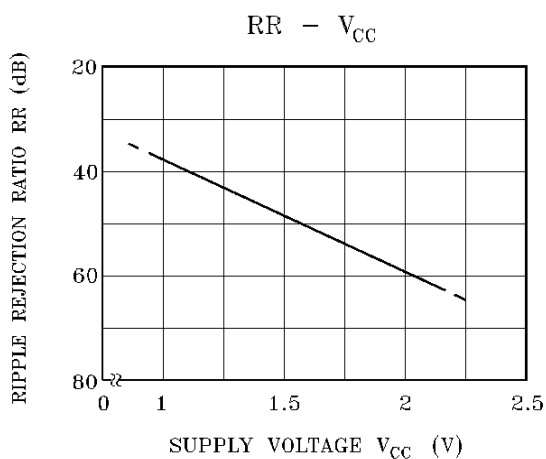
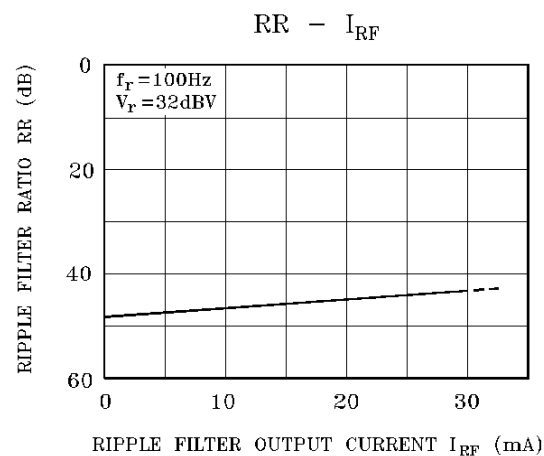
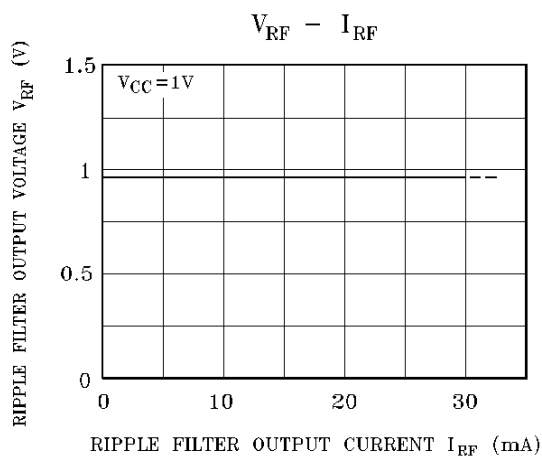
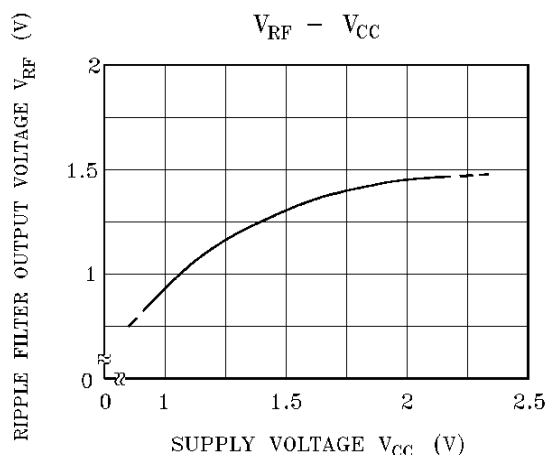
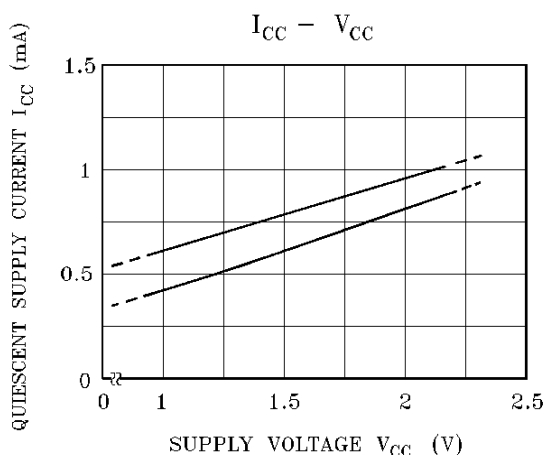

KIA2015FN

