

FM IF DIVERSITY IC

The KIA2017FN is a double-front-end type FM IF diversity IC developed for use in car tuners. For diversity, all you need is an FM front end and this IC. The FM IF diversity IC can be easily combined with main tuner RF processor KIA2074AF and FM processor KIA2093F. An excellent space factor and shrink package delivers diversity in the smallest possible space.

FUNCTIONS

- 2-type IF limiter amp.
- 2-type high-speed electric field detection.
- High-speed electric field detection DC offset control (slider)
- 2-type noise amp.
- Advanced multi-path detector.
- 2-type IF switch drive.
- Diversity mode switch.
- Operating power supply voltage range : $V_{opr}=7\sim 9V$.

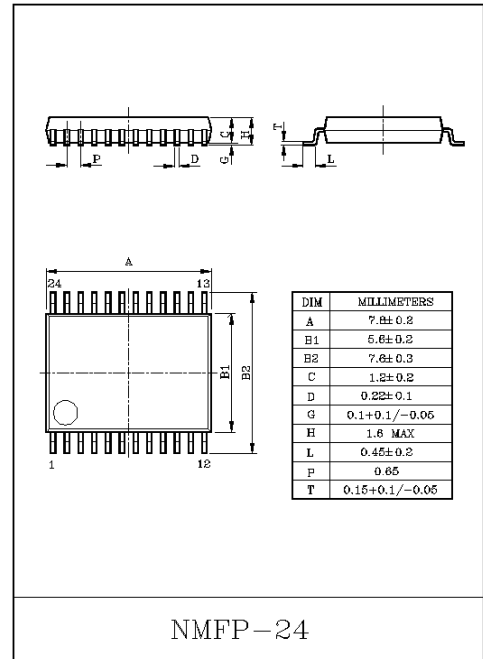

FEATURES

- Incorporates two types of high-speed electric field detector which are equivalent to each other in terms of silicon chip structure. Thus, high-precision comparison/detection of small deviations such as multi-path noise can be easily performed.
- Advanced multi-path detector employs a new method which separates the output of the two high-speed electric field detectors into a transient signal and an average electric field signal, then performs sharing (ratio subtraction) of the average electric field signal using the transient signal. This method allows diversity operation from weak to strong electric fields ; in other words, across a range of electric field detection output.
- To extract transient signals such as multi-path noise, incorporates an efficient noise amp.
- Incorporates a useful slider which absorbs deviations in electric field detection output by connecting gain deflection in the front end to the previous step.
- Diversity modes (auto, main antenna fixed, sub antenna fixed) are switched by direct microcontroller control.
- The constants of external components have low values. thus, all components can be integrated on a single 15×40mm printed circuit board.

KIA2017FN

MAXIMUM RATINGS (Ta=25°C)

CHARACTERISTIC	SYMBOL	RATING	UNIT
Power Supply Voltage	V _{CC}	10	V
Power Dissipation	P _D (Note)	550	mW
Operating Temperature	T _{opr}	-40~85	°C
Storage Temperature	T _{stg}	-55~150	°C
Drain Current of Pin 5	I ₅	4	mA
Drain Current of Pin 8	I ₈	4	mA

(Note) Derated above Ta=25°C in the proportion of 6.3mW/°C.

ELECTRICAL CHARACTERISTICS (Unless otherwise specified, V_{CC}=8.5V, Ta=25°C, fi=10.7MHz, Vi=Vi(main)=Vi(sub)=80dBμV (CW, SW₁=b, SW₂=off))

CHARACTERISTIC	SYMBOL	TEST CONDITION	MIN.	TYP.	MAX.	UNIT	
Quiescent Current	I _{CC}	V _i =-20dBμV CW (Except 1SV237 current)	17	25	33	mA	
Meter Output	V _{CO(Main)}	V _i =20dBμV CW	0	0.4	0.7	V	
	V _{CO(Sub)}		0	0.4	0.7		
	V _{C1(Main)}	V _i =40dBμV CW	0.2	0.6	0.9		
	V _{C1(Sub)}		0.2	0.6	0.9		
	V _{C2(Main)}	V _i =60dBμV CW	-	1.6	-		
	V _{C2(Sub)}		-	1.6	-		
	V _{C3(Main)}	-	2.1	2.9	3.5		
	V _{C3(Sub)}		2.1	2.9	3.5		
	V _{C4(Main)}	V _i =100dBμV CW	-	4.2	-		
	V _{C4(Sub)}		-	4.2	-		
	V _{C5(Main)}	V _i =120dBμV CW	3.6	4.8	5.4		
	V _{C5(Sub)}		3.6	4.8	5.4		
Meter Output for AM	V _{CAM1(Main)}	AM=19kHz 30%	1.7	2.2	2.7	V	
	V _{CAM1(Sub)}		1.7	2.2	2.7		
	V _{CAM2(Main)}	AM=19kHz 80%	-	0.8	-		
	V _{CAM2(Sub)}		-	0.8	-		
Meter Output Offset	ΔV _{C1}	V _{C(Main)} monitor, SW ₁ =b→a	-0.5	-0.3	-	V	
	ΔV _{C2}	V _{C(Main)} -V _{C(Sub)} , SW ₁ =b	-0.4	0	0.4		
	ΔV _{C3}	V _{C(Main)} monitor, SW ₁ =b→c	-	0.3	0.5		
Hysteresis	Hys	V _{i(Main)} =75dBμV CW, initial value V _{i(Sub)} =65dBμV, V ₅ , V ₈ monitor, Hys=V _{i(Sub)} -V _{i(Main)}	-	±2	-	dBμV	
Diversity Output	V ₅ , V ₈	-	6.4~ 4.7	7.0~ 5.3	7.4~ 5.7	V	
Mode Select Threshold Voltage	V _{th1}	SW ₂ =on	V5=L→H	-	1.8	-	V
	V _{th2}		V8=L→H	-	3.2	-	

KIA2017FN

SYSTEM BLOCK DIAGRAM

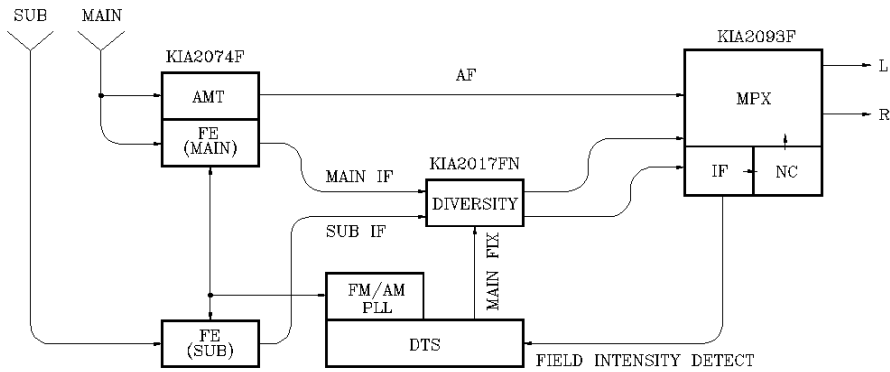

BLOCK DIAGRAM AND APPLICATION CIRCUIT

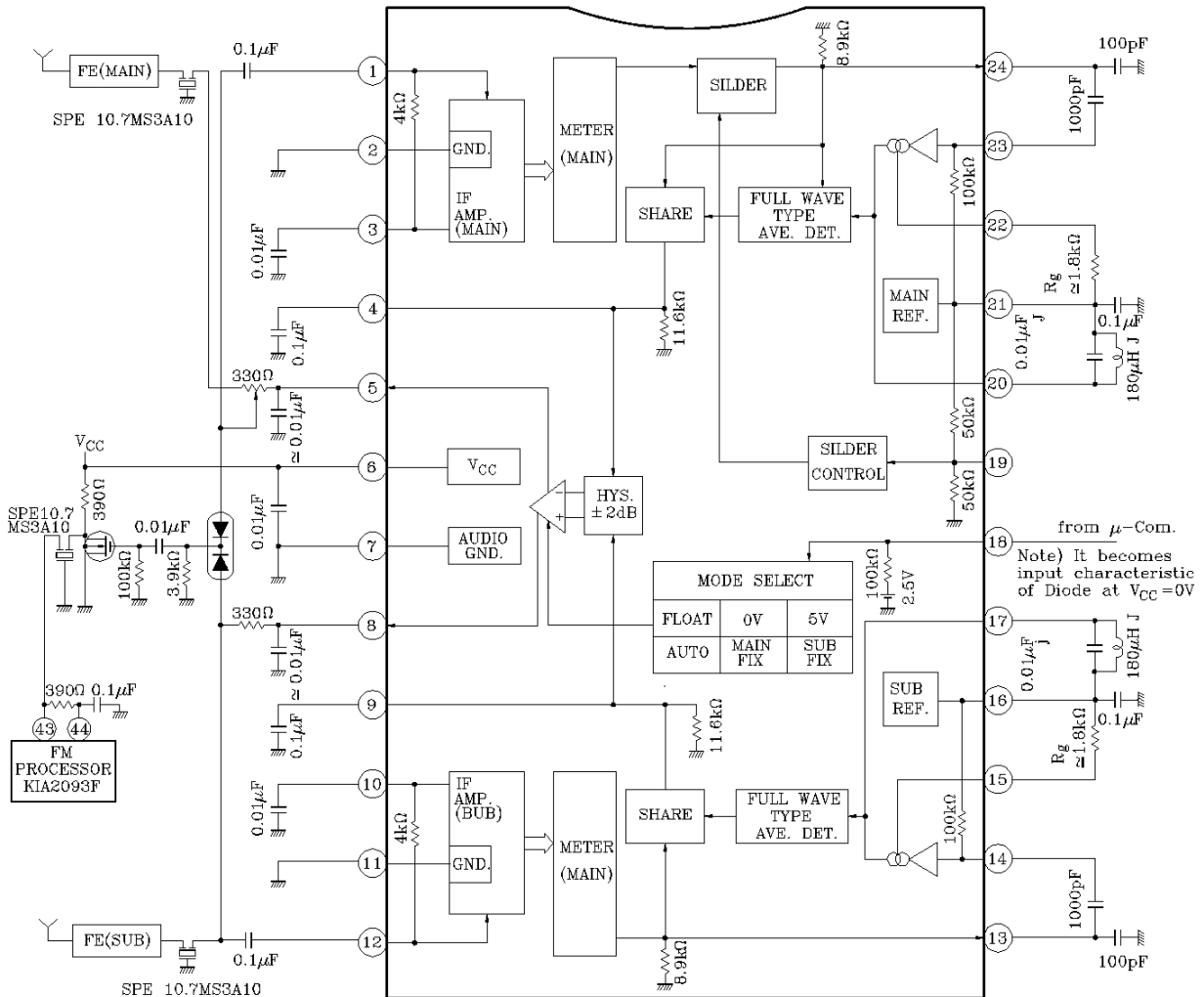

Note) When V_{CC}=0V, diode input characteristics are obtained.

KIA2017FN

TEST CIRCUIT

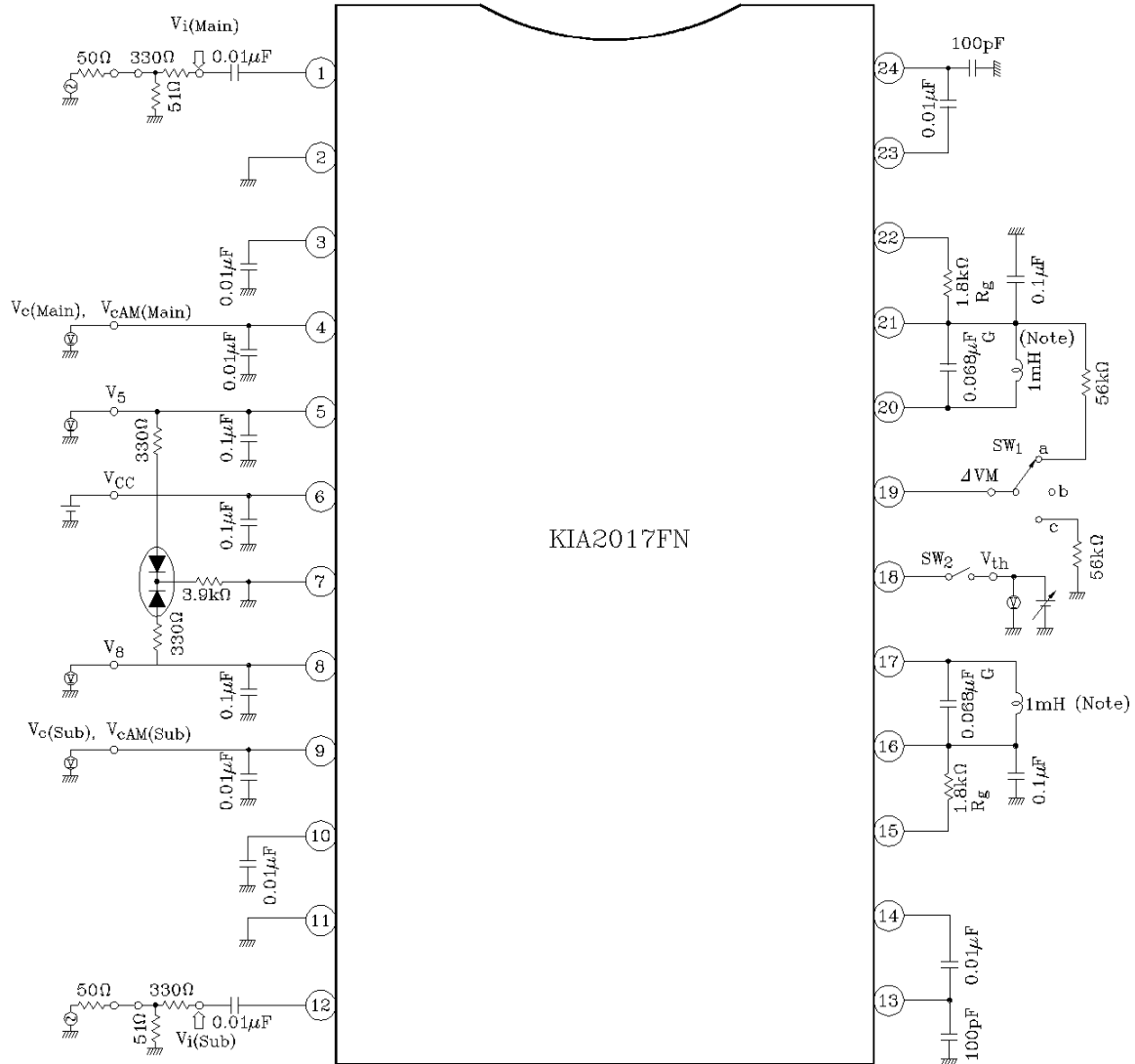

(NOTE) INDUCTOR SPECIFICATION

$L=1\text{mH} \pm 2\%$ at $f=19\text{kHz}$

$Q \approx 22$

$R = 5\Omega$

$V=100\text{mV}_{\text{rms}}$

KIA2017FN

PIN FUNCTION

(Pin voltage is a typical value when $V_{CC}=8.5V$, $T_a=25^{\circ}C$, and no DC signal is input to the test circuit.)

PIN NO.	PIN NAME	PIN VOLTAGE (V)	INTERNAL EQUIVALENT CIRCUIT/EXTERNAL TYPICAL VALUE (INTERNAL R AND C VALUES ARE TYPICAL)	PIN FUNCTION
1	Main IF in	3.3		IF input pins for the main and sub channels. Connect a 10.7MHz ceramic filter externally.
12	Sub IF in			0
2	Main IF GND.	3.3		
11	Sub IF GND.			0.1
3	Main IF Bypass	7.0 or 5.3		
10	Sub IF Bypass			8.5
4	Main Control-out	0		
9	Sub Control-out			0
5	Main-out	0		
8	Sub-out			0
6	V_{CC}	0		
7	GND			0

KIA2017FN

PIN NO.	PIN NAME	PIN VOLTAGE (V)	INTERNAL EQUIVALENT CIRCUIT/EXTERNAL TYPICAL VALUE (INTERNAL R AND C VALUES ARE TYPICAL)	PIN FUNCTION
13	Sub Meter-out	0.25		Signal meter output pin for main and bus channels. Connect a capacitor externally. Then connect the capacitor to noise input pin 14/23 for the main or sub channel. The capacitor to be grounded is used for eliminating carrier included in signal meter output.
24	Main Meter-out			Pin function description for pin 24 is merged into the main description above.
14	Sub Noise-in	5.0		Pin function description for pin 14 is merged into the main description above.
23	Main Noise-in			Pin function description for pin 23 is merged into the main description above.
15	Sub Noise Gain	5.0		Pin function description for pin 15 is merged into the main description above.
22	Main Noise Gain			Pin function description for pin 22 is merged into the main description above.
16	Sub Reference	5.0		Pin function description for pin 16 is merged into the main description above.
21	Main Reference			Pin function description for pin 21 is merged into the main description above.
17	Sub Noise Det.	5.0		Pin function description for pin 17 is merged into the main description above.
20	Main Noise Det.			Pin function description for pin 20 is merged into the main description above.
18	Mode Select	2.5		Pin used to switch main and sub channels. Connect this pin to the micro controller. When pin voltage is 1.8V or less, the main channel is fixed ; When 3.2V or more, the sub channel is fixed. When $V_{CC}=0V$, diode input characteristics are obtained.

KIA2017FN

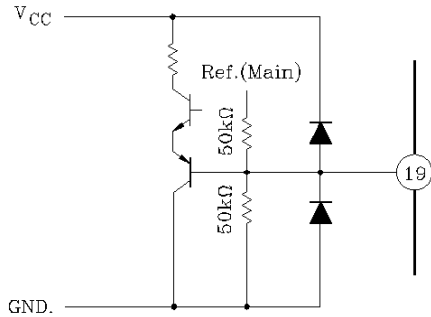
PIN NO.	PIN NAME	PIN VOLTAGE (V)	INTERNAL EQUIVALENT CIRCUIT/EXTERNAL TYPICAL VALUE (INTERNAL R AND C VALUES ARE TYPICAL)	PIN FUNCTION
19	Slider	2.5		<p>Pin used to control sliding amount for the main channel signal meter output. Adjust the signal meter DC offset as necessary by connecting a resistor between pin 19 and pin21, which is the main channel reference voltage pin, and grounding the resistor.</p>

KIA2017FN

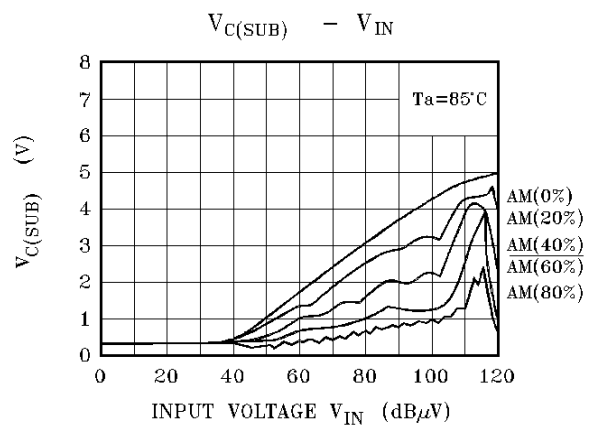
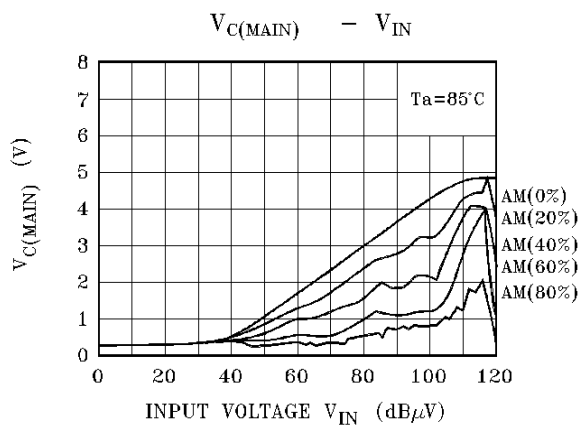
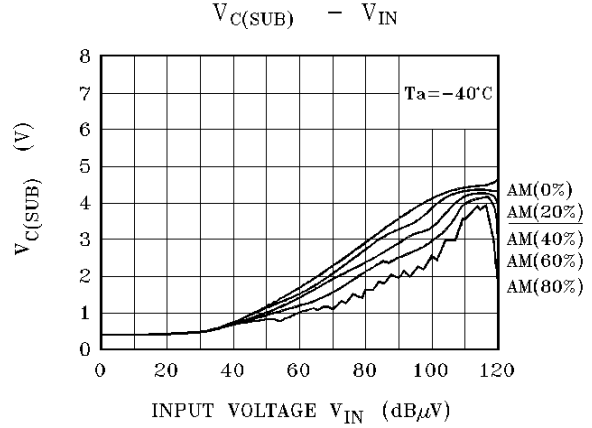
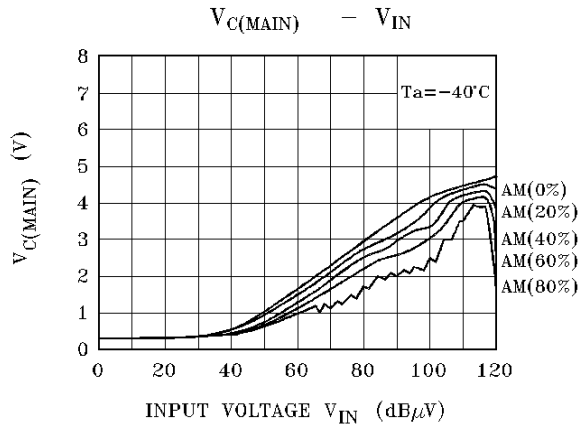
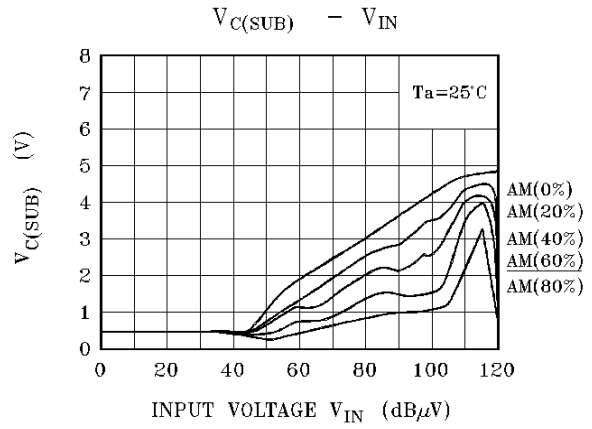
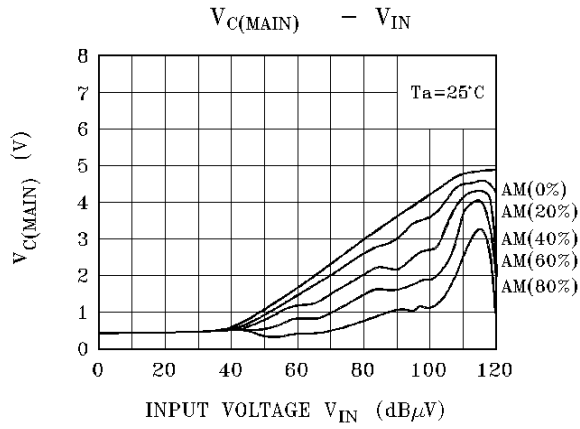

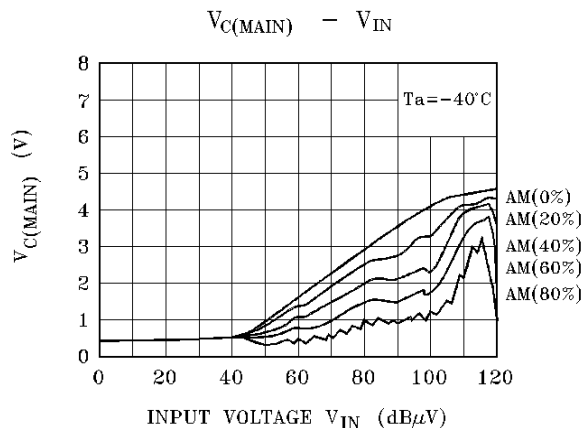
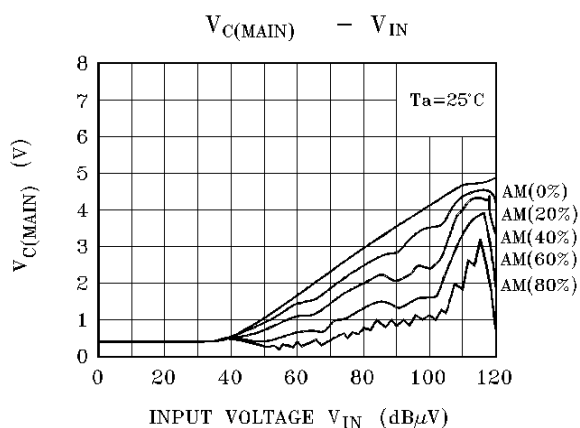

IC temperature characteristics (Measure the temperature characteristics of the IC by using the resistor instead of the resonant circuit.)

At room temperature vary R_1 and R_2 to obtain the same condition (Gain) as when the resonant circuit is connected.

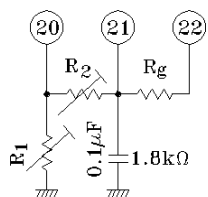

resonant circuit is connected.

R_1 : DC potential adjustment.

R_2 : Gain adjustment.

$$\text{Gain} = \frac{R_1/R_2}{R_g}$$

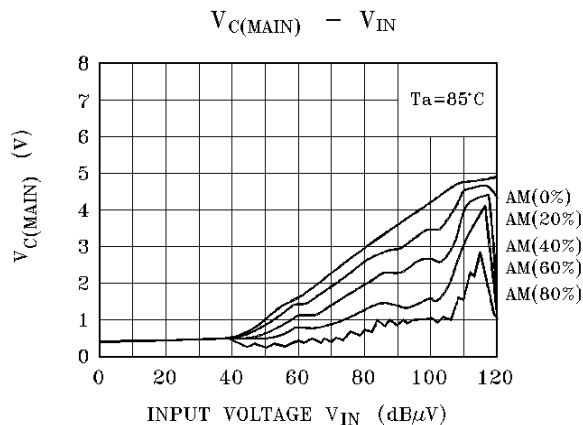

At high or low temperature adjust R_1 to DC ; R_2 to the gain at room temperature.

Shown below are the temperature characteristics of the resonant circuit (temperature characteristics of external components) under the above conditions.

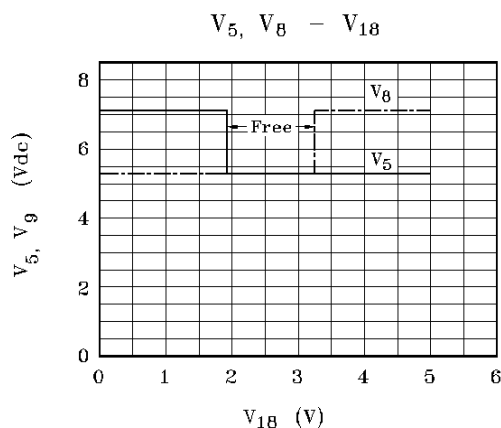
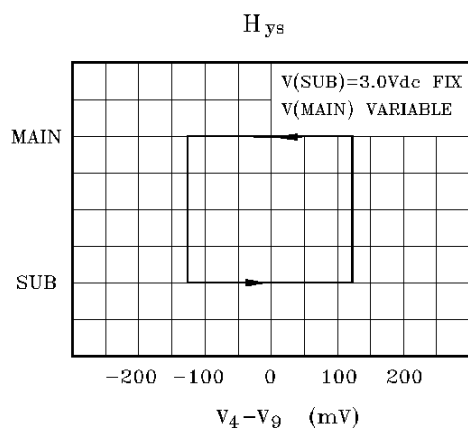

KIA2017FN

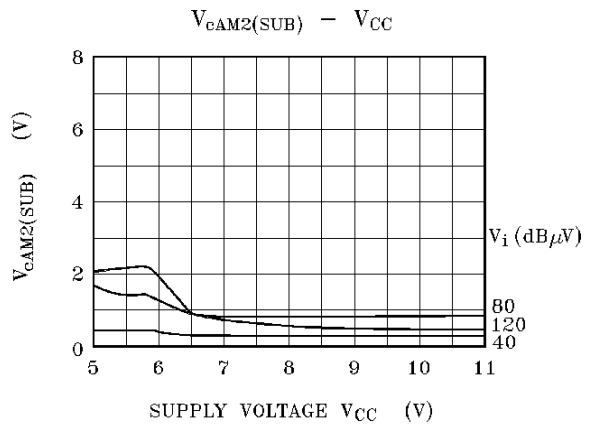
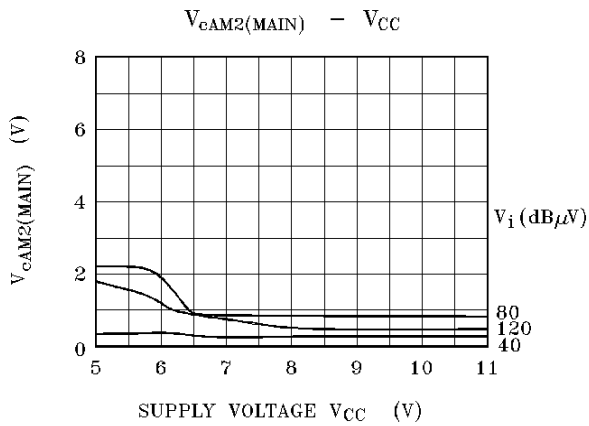
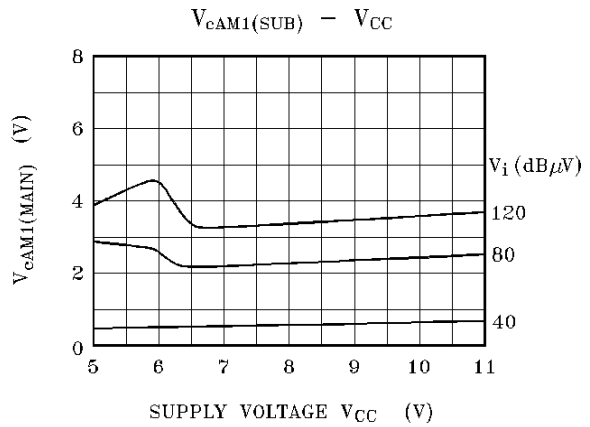
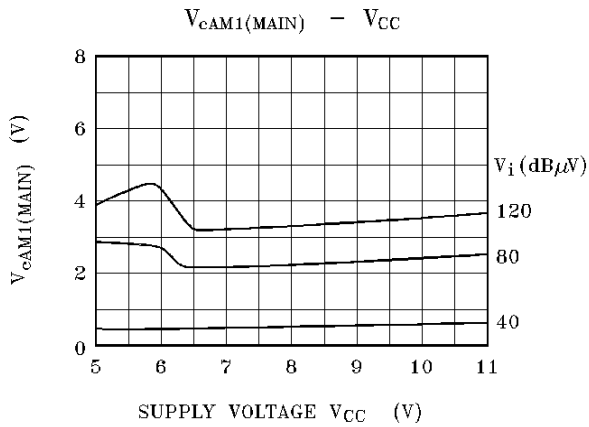
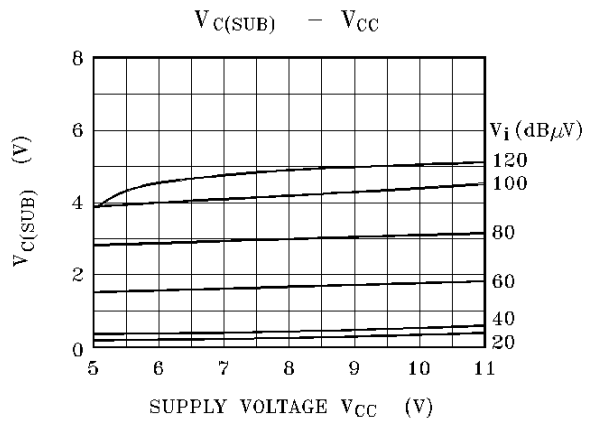
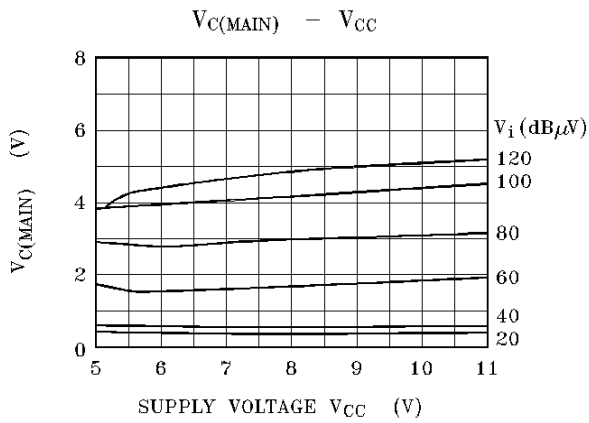

KIA2017FN

