

MULTI OUTPUT VOLTAGE REGULATOR FOR CD PLAYER.

The KIA8224H is voltage regulator IC, designed for compact displayer use, built in 3 outputs and reset circuit. In addition, protection of over voltage, output to GND short and thermal shut down are involved.

FEATURES

- 3 Regulated voltage outputs
 - $V_{OUT(1)}$ (for μ -com system)
 - : Fixed voltage output
 - : $V_{OUT1}=5V(Typ.) / 100mA(Max.)$
 - $V_{OUT(2)}$ (for servo system)
 - : Fixed voltage output
 - : $V_{OUT2}=5V(Typ.) / 300mA(Max.)$
 - $V_{OUT(3)}$ (for driver)
 - : Adjustable voltage output
 - : $V_{OUT3}=8V(Typ.) / 1.2A(Max.)$
- Built-in reset circuit : 2 input, 1 output
 - : Reset sense voltage $V_R=3.6V (Ta=25^\circ C)$
- Built-in stand-by circuit
 - : Servo system, driver
Power→ON/OFF STB 2 : (③ pin)
 - : μ -com system, servo system,
Driver power→ON/OFF STB 1 : (① pin)
- Built-in various protection circuits
 - : Over voltage, output to GND short, thermal shut down.
- Operating voltage ($Ta=25^\circ C$)
 - : $V_{IN(oper)}=7.5\sim 20V$: (Operating for $V_{out 1,2,3}$)
 - : $V_{IN(oper)}=7.5\sim 24V$: (Operating for $V_{out 1}$ only)

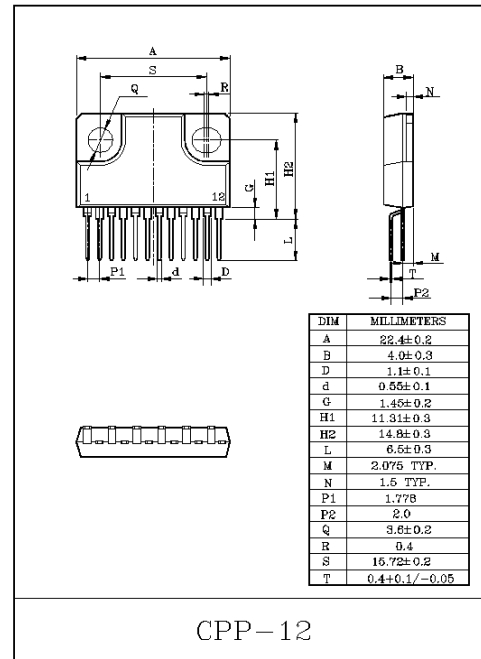

MAXIMUM RATINGS ($Ta=25^\circ C$)

CHARACTERISTIC	SYMBOL	RATING	UNIT
DC Input Voltage	V_{CC}	30	V
Power Dissipation	P_D (Note)	25	W
Operating Temperature	T_{opr}	-25~75	$^\circ C$
Storage Temperature	T_{stg}	-55~150	$^\circ C$

Note) Derated above $Ta=25^\circ C$ in the proportion 200mW/ $^\circ C$

KIA8224H

ELECTRICAL CHARACTERISTICS

(Unless otherwise specified, $V_{IN}=12V$, $I_{OUT1}=100mA$, $I_{OUT2}=300mA$, $I_{OUT3}=300mA$, $T_a=25^{\circ}C$)

CHARACTERISTIC	SYMBOL	TEST CIRCUIT	TEST CONDITION	MIN.	TYP.	MAX.	UNIT	
Output Voltage	V_{OUT1}	-	-	4.8	5.0	5.3	V	
	V_{OUT2}	-	-	4.8	5.0	5.3		
	V_{OUT3}	-	$R_1=18k\Omega$, $R_2=39k\Omega$	7.7	8.0	8.3		
Line Regulation	Reg1. line	-	$7.5V \leq V_{IN} \leq 24V$	-	20	100	mV	
	Reg2. line	-	$7.5V \leq V_{IN} \leq 20V$	-	20	100		
	Reg3. line	-	$10.3V \leq V_{IN} \leq 20V$	-	20	150		
Load Regulation	Reg1. load	-	$0mA \leq I_{OUT1} \leq 100mA$	-	20	100	mV	
	Reg2. load	-	$5mA \leq I_{OUT2} \leq 300mA$	-	20	100		
	Reg3. load	-	$5mA \leq I_{OUT3} \leq 300mA$	-	20	100		
			$5mA \leq I_{OUT3} \leq 1.2A$	-	50	-		
Ripple Rejection Ratio	R.R. 1	-	$V_{IN}=1V_{rms}$ $f=120Hz$	$10V \leq V_{IN} \leq 24V$	60	70	-	dB
	R.R. 2	-		$11V \leq V_{IN} \leq 20V$	60	70	-	
	R.R. 3	-		$12V \leq V_{IN} \leq 20V$	52	64	-	
Drop Voltage	V_{D1}	-	$V_{IN}=6V$	-	1.8	-	V	
	V_{D2}	-	$V_{IN}=6V$	-	1.8	-		
	V_{D3}	-	$V_{IN}=8V$	-	1.5	-		
Maximum Output Current	I_{MAX1}	-	-	100	200	-	mA	
	I_{MAX2}	-		300	400	-		
	I_{MAX3}	-		1.2	1.5	-	A	
Output Short Current	I_{SC1}	-	-	-	250	-	mA	
	I_{SC2}	-		-	400	-		
	I_{SC3}	-		-	-	1.0	-	A
Output Noise Voltage	V_{NO1}	-	-	-	180	-	μV	
	V_{NO2}	-		-	230	-		
	V_{NO3}	-		-	260	-		
Output Voltage Temperature Coefficient	T_{CV01}	-	-	-	0.5	-	mV/ $^{\circ}C$	
	T_{CV02}	-		-	-1.1	-		
	T_{CV03}	-		-	-1.2	-		
Bias Current	I_B	-	$I_{OUT1}=0mA$, $V_{OUT2, 3}$ -OFF	-	0.6	1.2	mA	
Reset Sense Voltage	V_R	-	-	3.4	-	3.75	V	
Hysteresis Voltage	ΔV_H	-	-	-	60	-	mV	
Output Saturation Voltage	V_{sat}	-	$R_3=510\Omega$	-	0.3	1.0	V	
Sensing Voltage Temperature Coefficient	$T_c VO4$	-	-	-	0.5	-	mV/ $^{\circ}C$	
Stand-by Current	I_{stb}	-	$V_1=0V$, $V_{OUT2, 3}$ -OFF	-	180	300	μV	
Threshold Voltage	V_{Sstb2}	-	-	1.2	-	3.0	V	

KIA8224H

BLOCK DIAGRAM

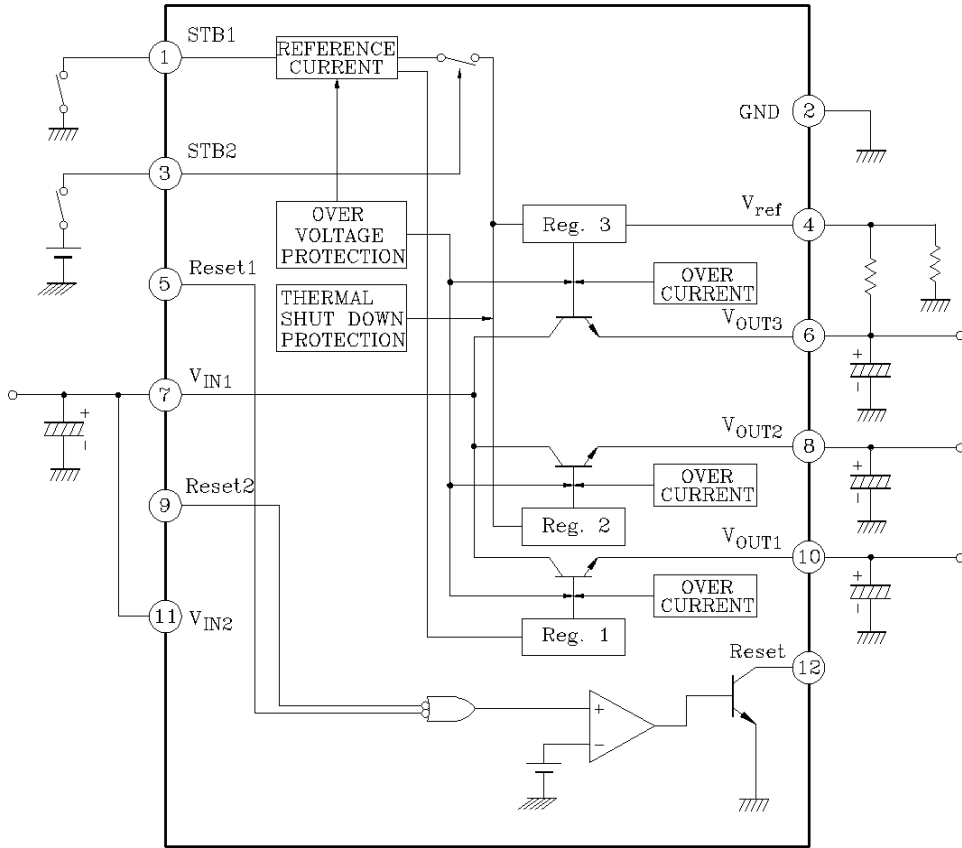

EXPLANATION FOR EACH TERMINAL

PIN NO.	SYMBOL	FUNCTION	REMARKS
1	STB1	Stand-by switch for Vout _{1,2,3}	GND terminal for bias circuit ①→GND : Power ON ①→OPEN : Power OFF
2	GND	GND	-
3	STB2	Stand-by switch for Vout _{2,3}	V _S STB ₂ ≥ 3.0V : V _{OUT2,3} ON ≤ 1.2V : V _{OUT2,3} OFF
4	V _{ref}	Reference for Vout ₃	-
5	Reset1	Reset input 1	V _{R1} ≤ 3.4V : Reset, ΔV _H = 60mV (Typ.)
6	V _{OUT3}	Adjustable voltage output	Adjustable by External Resistor R ₁ and R ₂
7	V _{IN1}	Input terminal 1	Driver stage supply terminal
8	V _{OUT2}	Output for servo system	5V Output
9	Reset2	Reset input 2	V _{R2} ≤ 3.4V : Reset, ΔV _H = 60mV (Typ.)
10	V _{OUT1}	Output for μ-com system	5V Output
11	V _{IN2}	Input 2	-
12	Reset	Reset Output	Open collector output

KIA8224H

TEST CIRCUIT

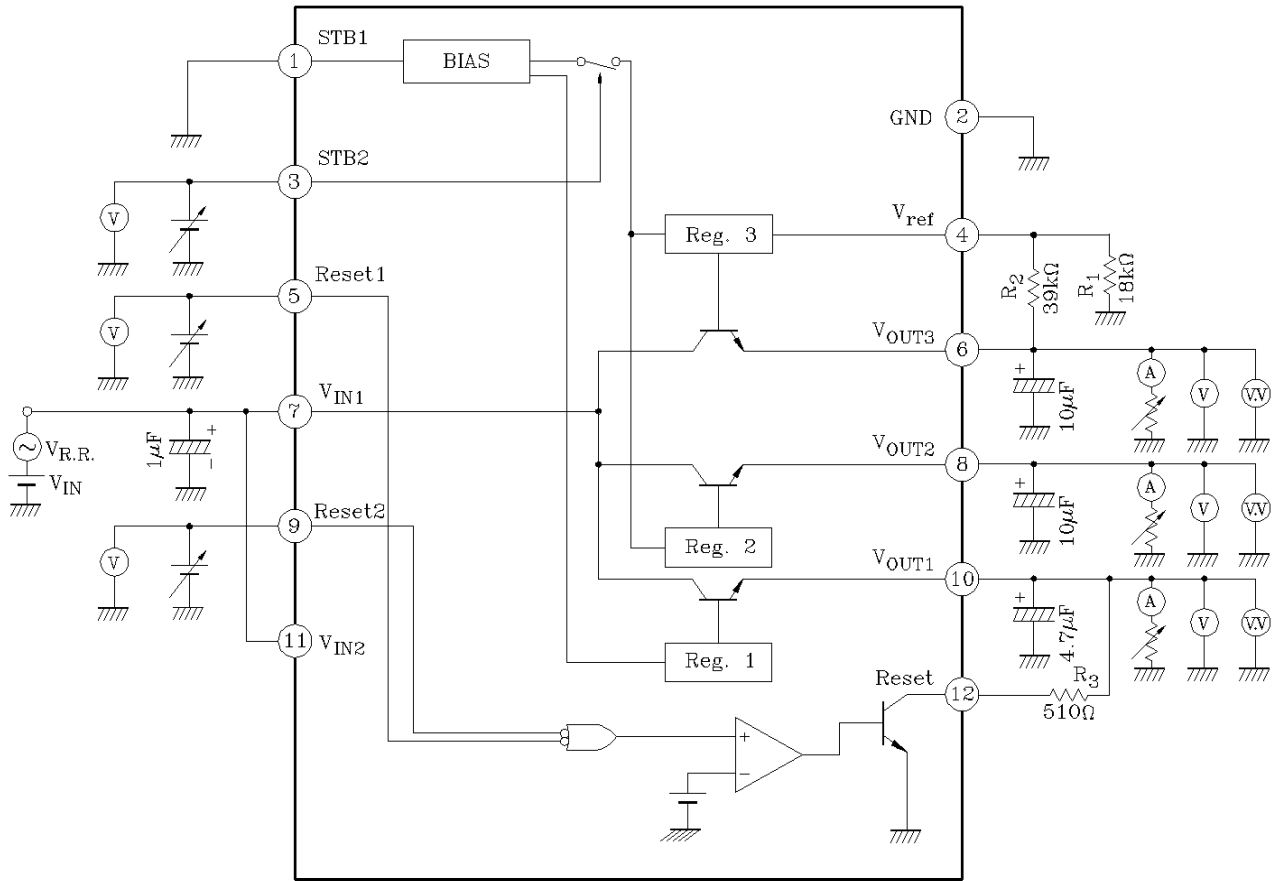

KIA8224H

APPLICATION CIRCUIT

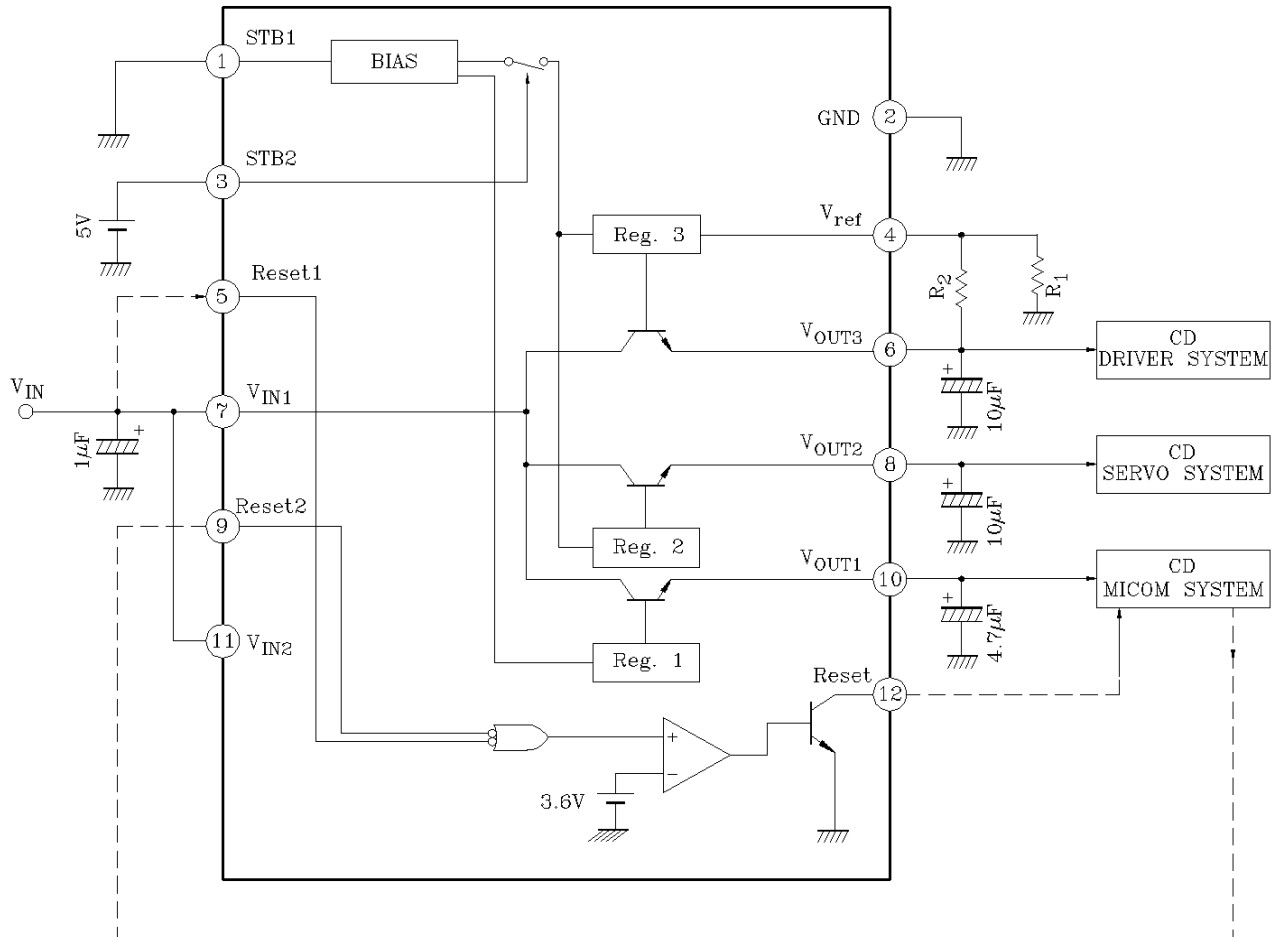

KIA8224H

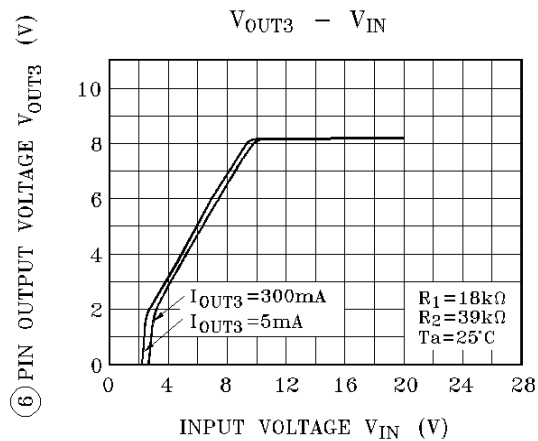
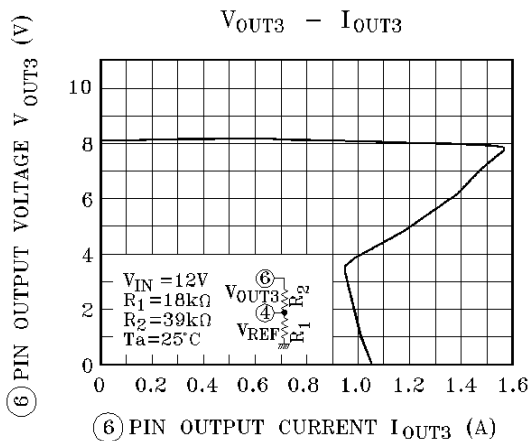
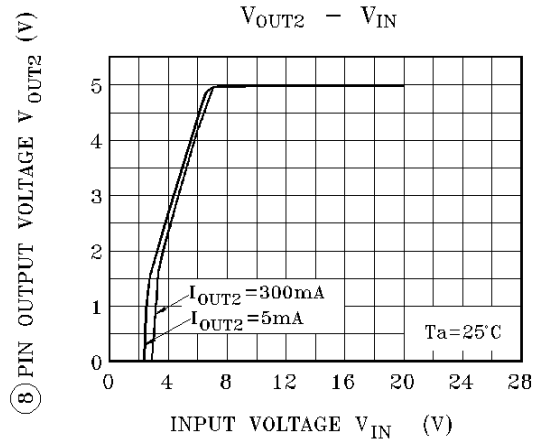
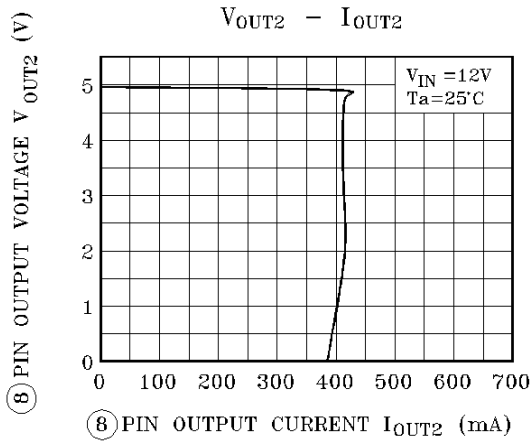
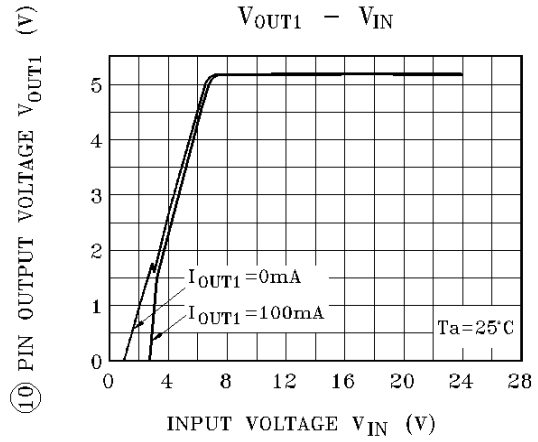
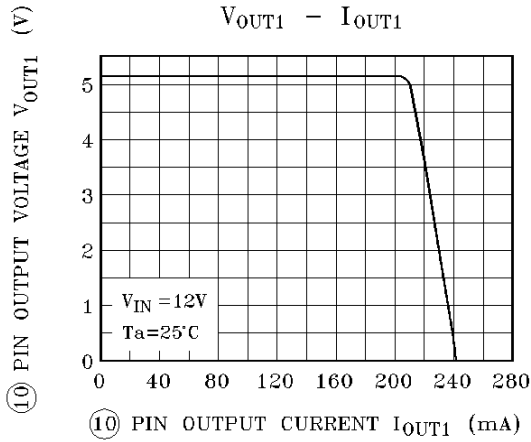

KIA8224H

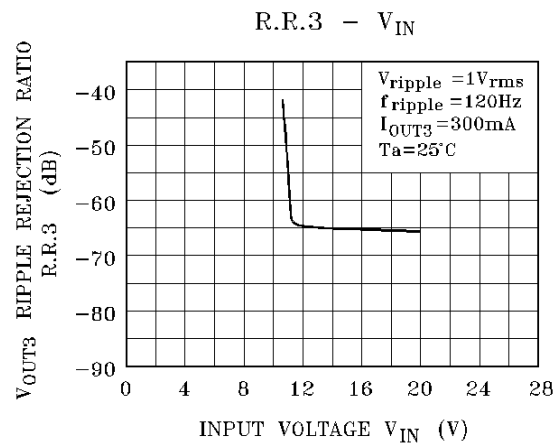
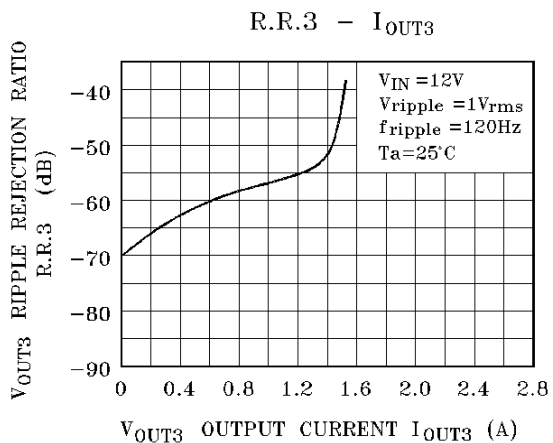
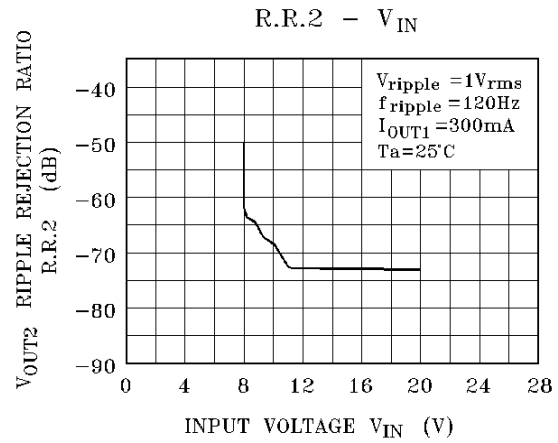
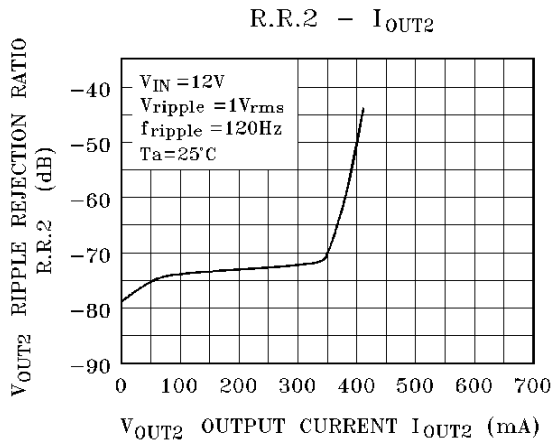
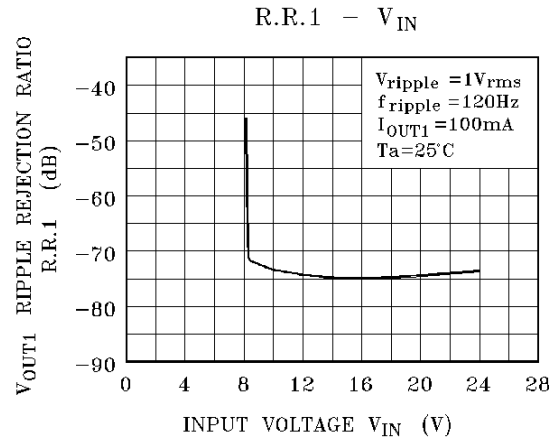
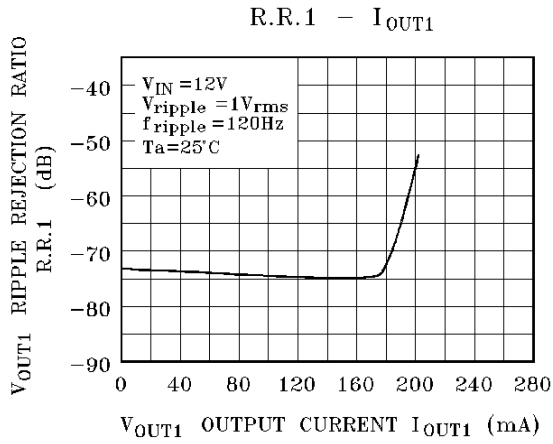

KIA8224H

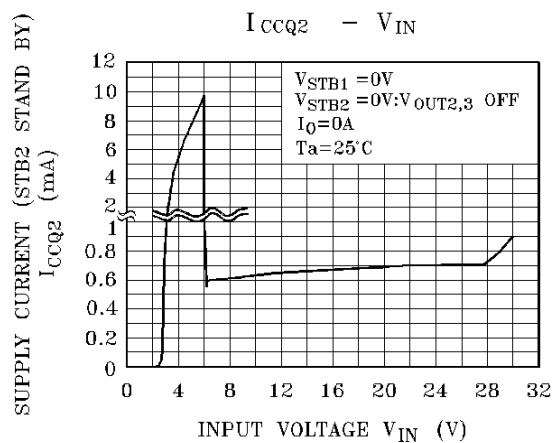
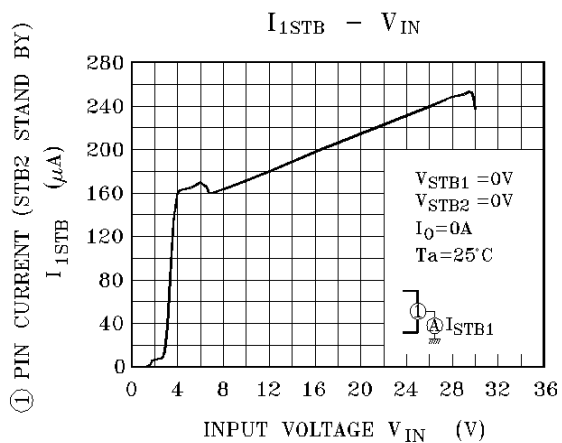
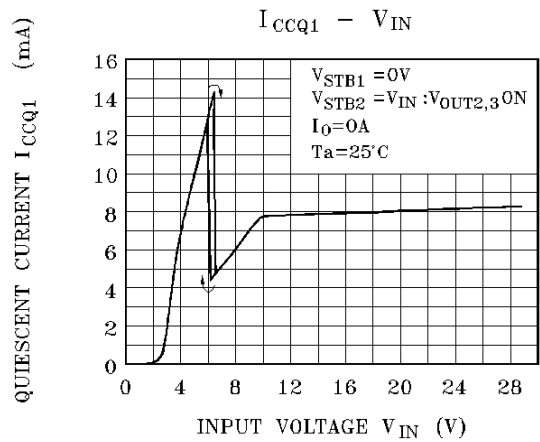
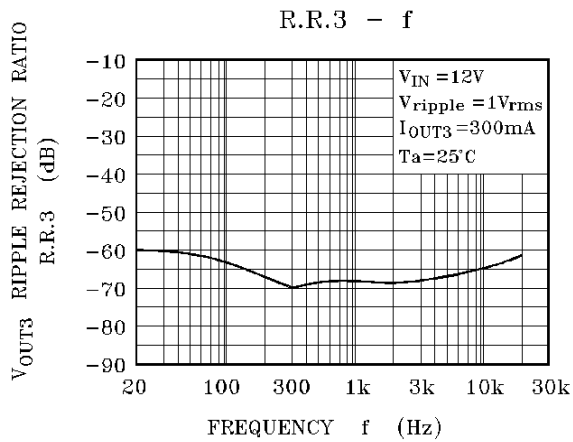
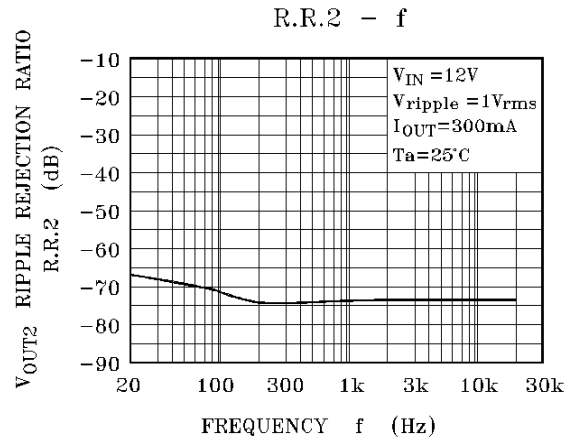
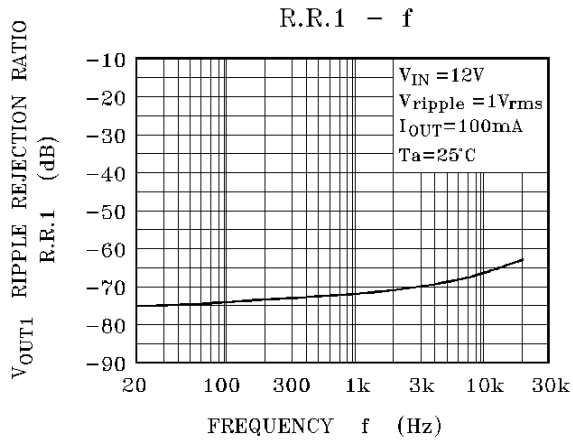

KIA8224H

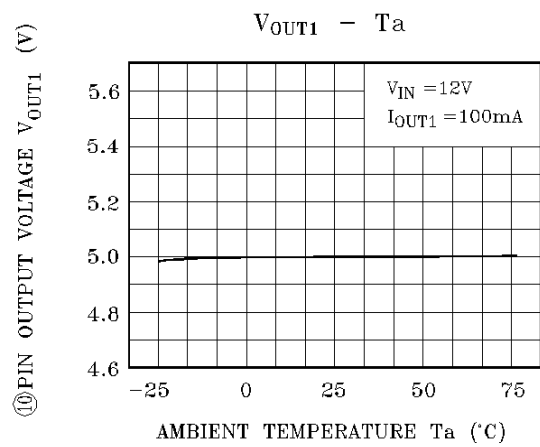
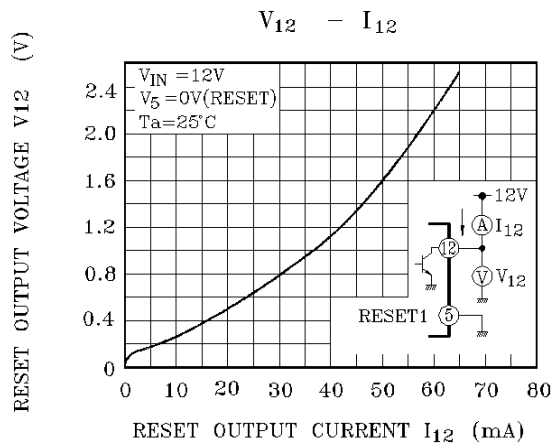
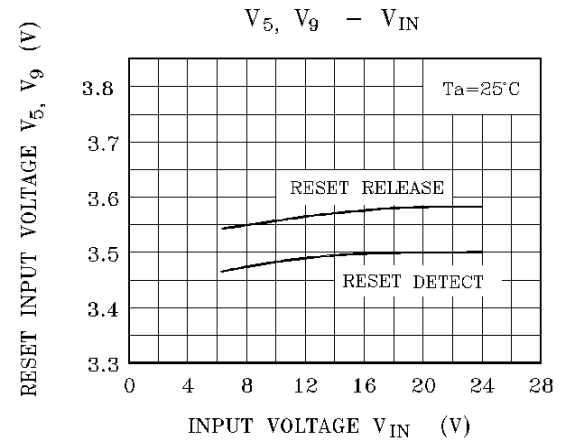
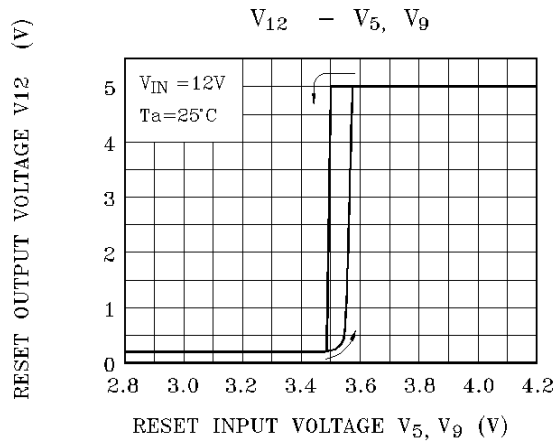
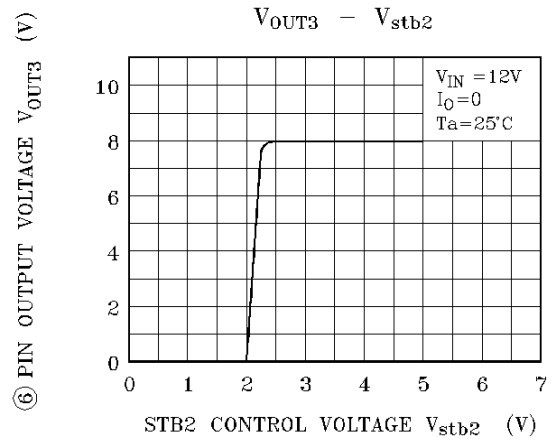
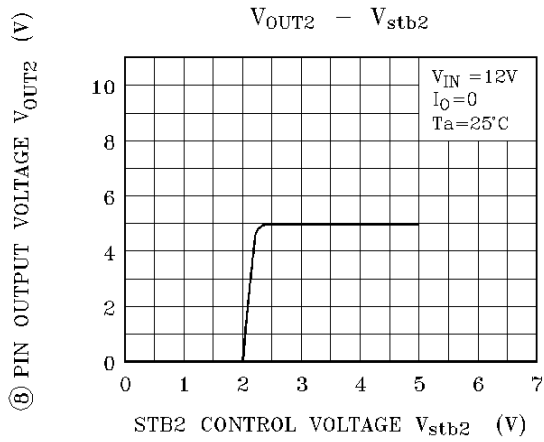

KIA8224H

