

150mA CMOS High Performance LDO Regulator

The KIC3210T series Low Dropout Linear Regulator is ideally suited for portable applications. It offers 1% initial accuracy, extremely-low dropout voltage(135mV at 150mA) and low ground current (typically 90uA). Designed specifically for handheld and battery-powered devices, the KIC3210T provides a TTL-logic-compatible ON/OFF control pin. When disabled, power consumption drops nearly to zero. The KIC3210T also works with low-ESR ceramic capacitors, reducing the amount of board space necessary for power applications, critical in handheld wireless devices.

Features

- Input voltage range : 2.7V to 6.0V
- Stability with ceramic output capacitors
- Ultra-low dropout : 135mV @ 150mA
- High output accuracy : 1.0% accuracy
- Low quiescent current : 90μA
- TTL-Logic-compatible ON/OFF control input
- "Zero" off-mode current
- Thermal shutdown and current limit protection

Applications

- Cellular phones, Smart Phones, PDA
- Battery-powered equipment
- Laptop, notebook and palmtop computers
- Consumer/personal electronics

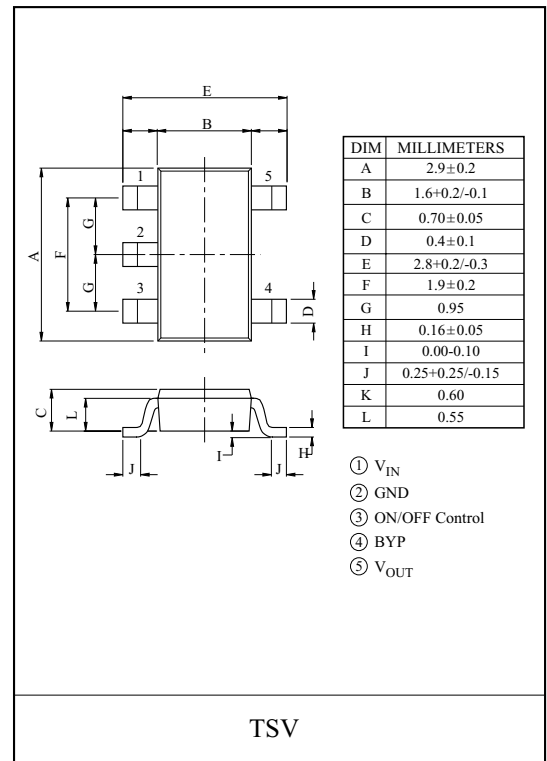

Marking

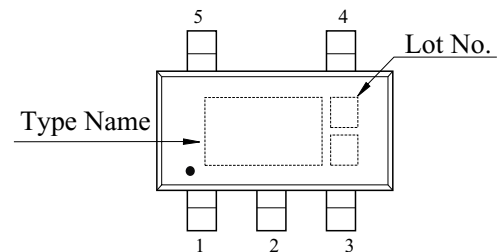

KIC3210T-018 ~ KIC3210T-035

Line up

Item	Output Voltage	Marking	Package	Item	Output Voltage	Marking	Package
KIC3210T-018	1.8V	18A	TSV	KIC3210T-275	2.75V	27B	TSV
KIC3210T-019	1.9V	19A		KIC3210T-028	2.8V	28A	
KIC3210T-020	2.0V	20A		KIC3210T-285	2.85V	28B	
KIC3210T-021	2.1V	21A		KIC3210T-029	2.9V	29A	
KIC3210T-022	2.2V	22A		KIC3210T-030	3.0V	30A	
KIC3210T-023	2.3V	23A		KIC3210T-031	3.1V	31A	
KIC3210T-024	2.4V	24A		KIC3210T-032	3.2V	32A	
KIC3210T-025	2.5V	25A		KIC3210T-033	3.3V	33A	
KIC3210T-026	2.6V	26A		KIC3210T-034	3.4V	34A	
KIC3210T-027	2.7V	27A		KIC3210T-035	3.5V	35A	

Pin Configuration

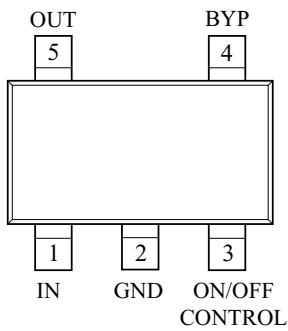

No.	Symbol	Description
1	INPUT	Supply Input
2	GND	Ground
3	ON/OFF CONTROL	Enable/Shutdown (Input) : CMOS compatible input. Logic high=enable, logic low=shutdown. Do not leave open.
4	BYP	Reference Bypass : Connect external $0.01 \mu\text{F} \leq C_{\text{BYP}} \leq 1.0 \mu\text{F}$ capacitor to GND to reduce output noise. May be left open.
5	OUTPUT	Regulator Output

Application Circuit

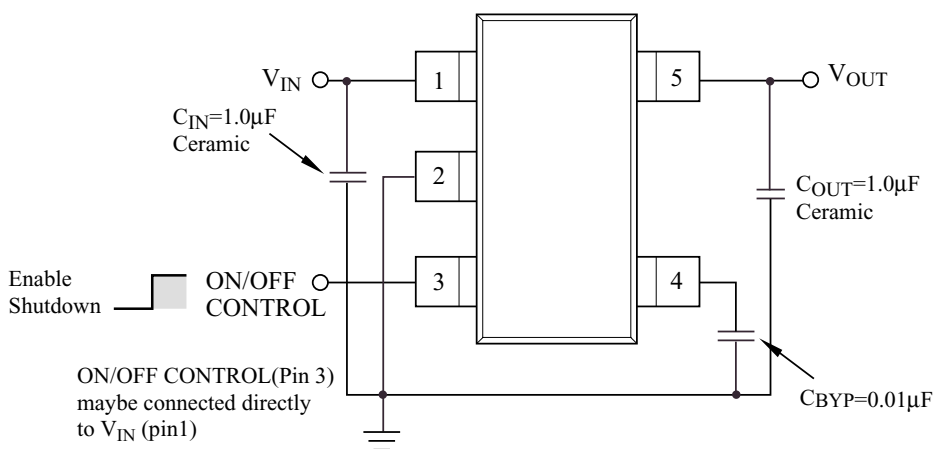

KIC3210T-018 ~ KIC3210T-035

Absolute Maximum Ratings

Characteristics	Symbol	Rating	Units
Input Voltage	V_{IN}	6	V
Output Current	I_{OUT}	150	mA
Output Voltage	V_{OUT}	1.8~3.5	V
Power Dissipation ^{Note}	P_D	900	mW
Operating Temperature	T_{OPR}	-40 ~ 85	°C
Storage Temperature	T_{STG}	-65 ~ 125	°C

Note) Package Mounted on a Ceramic board (600mm² × 0.8mm)

Electrical Characteristics

($V_{IN}=V_{OUT}+1V$, $V_{EN}=V_{IN}$, $I_{OUT}=100\mu A$, $T_a=25^\circ C$)

Parameter	Symbol	Conditions	Min	Typ	Max	Units
Output Voltage Accuracy	V_O	$I_{OUT}=100\mu A$	-1	-	1	%
Load Regulation	Reg Load	$I_{OUT}=0.1mA \sim 150mA$	-	1.5	2.5	%
Line Regulation	Reg Line	$V_{IN}=V_{OUT}+1V \sim 6V$	-	0.1	0.2	%/V
Dropout Voltage ^{Note 1)}	V_D	$I_{OUT}=100\mu A$	-	0.1	5	mV
		$I_{OUT}=100mA$	-	90	150	mV
		$I_{OUT}=150mA$	-	135	200	mV
Quiescent Current	I_Q	$V_{EN} \leq 0.4V$ (shutdown)	-	0.2	1	μA
Ground Pin Current ^{Note 2)}	I_{GND}	$I_{OUT}=0mA$	-	90	150	μA
		$I_{OUT}=150mA$	-	117	150	μA
Ripple Rejection	R.R	$f=10Hz$, $C_{OUT}=1.0\mu F$, $C_{BYP}=0.01\mu F$	-	60	-	dB
		$f=100Hz$, $V_{IN}=V_{OUT}+1$	-	60	-	dB
		$f=10kHz$, $V_{IN}=V_{OUT}+1$	-	50	-	dB
Current Limit	I_{LIM}	$V_{OUT}=0V$	160	425	-	mA
Output Noise Voltage	V_{NO}	$C_{OUT}=1.0\mu F$, $C_{BYP}=0.01\mu F$ $f=10Hz \sim 100kHz$	-	50	-	μV_{rms}
Output Control Voltage (ON-State)	$V_{C(ON)}$	$V_{IN}=2.7V \sim 5.5V$, regulator enable	1.6	-	-	V
Output Control Voltage (OFF-State)	$V_{C(OFF)}$	$V_{IN}=2.7V \sim 5.5V$, regulator shutdown	-	-	0.4	V
Output Control Current	I_C	$V_C \geq 1.6V$, regulator enable	-	0.01	-	μA
		$V_C \leq 0.4V$, regulator shutdown	-	0.01	-	μA
Thermal Shutdown Temperature	T_{SD}		-	150	-	°C
Thermal Shutdown Hysteresis	T_{SD_HYS}		-	10	-	°C

Note 1) Dropout Voltage is defined as the input-to-output differential at which the output voltage drops 2% below its nominal value measured at 1V differential. For outputs below 2.5V, output voltage is stabilized from the minimum input voltage 2.6V

Note 2) Ground pin current is the regulator quiescent current. The total current drawn from the supply is the sum of the load current plus the ground pin current.

KIC3210T-018 ~ KIC3210T-035

Fig. 1 R.R

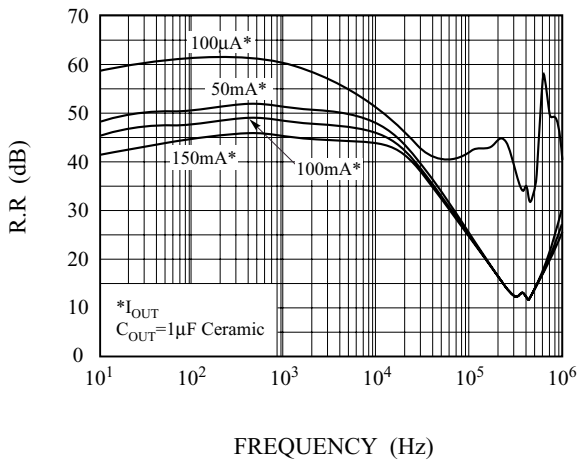

Fig. 2 V_{IN} - I_{GND}

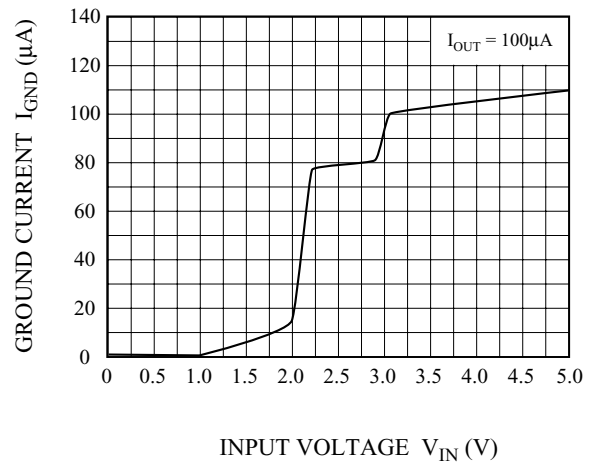

Fig. 3 V_{IN} - V_{OUT}

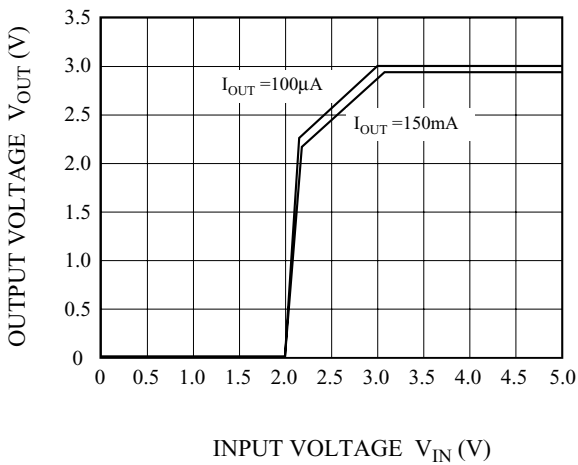

Fig. 4 T_a - V_{DROP}

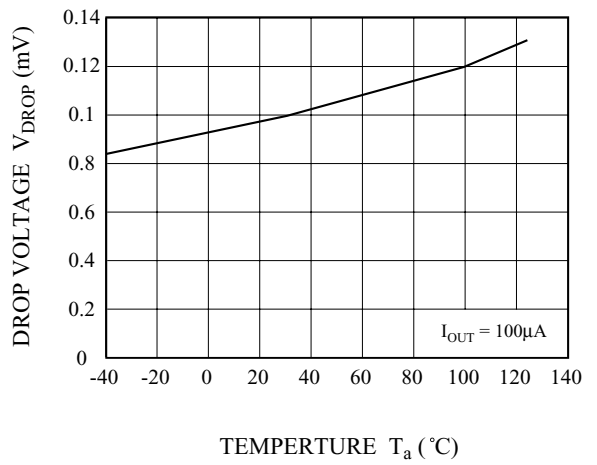

Fig. 5 T_a - V_{OUT}

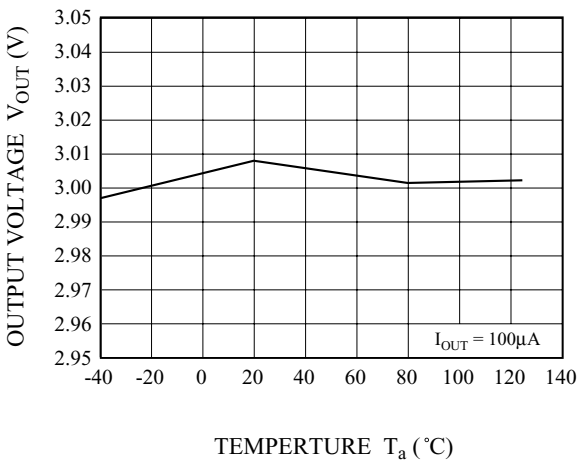
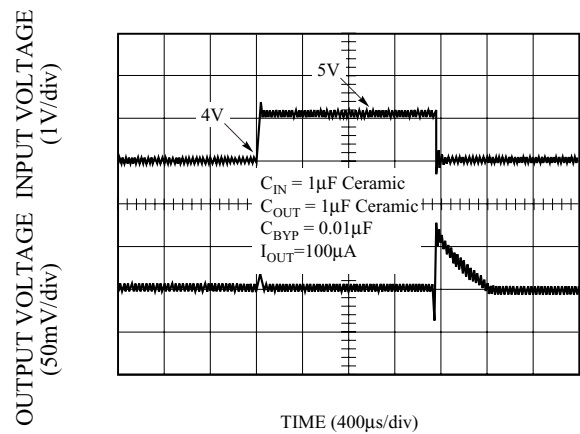

Fig. 6 Line Transient Response



KIC3210T-018 ~ KIC3210T-035

Fig. 7 Load Transient Response

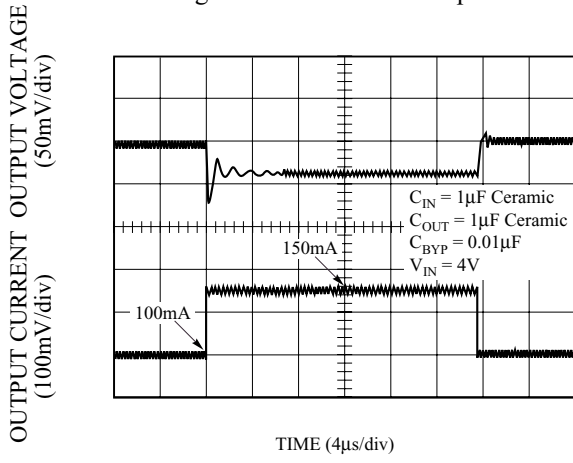

Fig. 8 ON/OFF Control Pin Delay

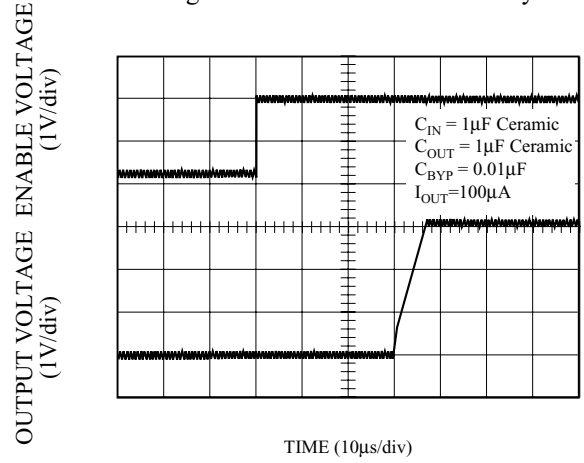

Fig. 9 Shutdown Delay

