

**KK74HC373A**

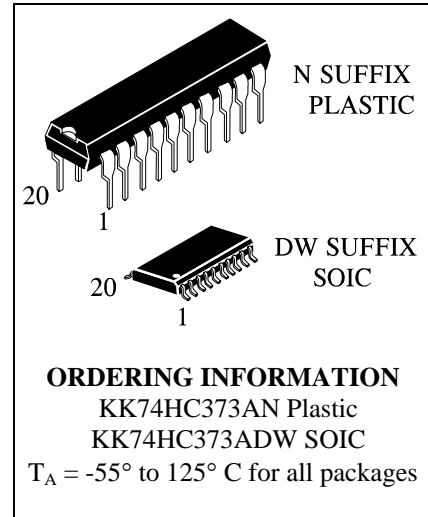
**Octal 3-State Noninverting  
Transparent Latch  
High-Performance Silicon-Gate CMOS**

The KK74HC373A is identical in pinout to the LS/ALS373. The device inputs are compatible with standard CMOS outputs; with pullup resistors, they are compatible with LS/ALSTTL outputs.

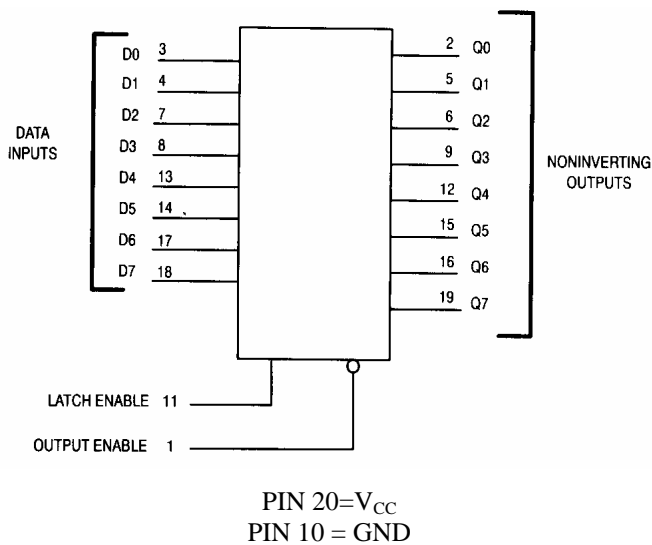
These latches appear transparent to data (i.e., the outputs change asynchronously) when Latch Enable is high. When Latch Enable goes low, data meeting the setup and hold time becomes latched.

The Output Enable input does not affect the state of the latches, but when Output Enable is high, all device outputs are forced to the high-impedance state. Thus, data may be latched even when the outputs are not enabled.

- Outputs Directly Interface to CMOS, NMOS, and TTL
- Operating Voltage Range: 2.0 to 6.0 V
- Low Input Current: 1.0  $\mu$ A
- High Noise Immunity Characteristic of CMOS Devices



**LOGIC DIAGRAM**



**PIN ASSIGNMENT**

OUTPUT ENABLE	1	20	$V_{CC}$
Q0	2	19	Q7
D0	3	18	D7
D1	4	17	D6
Q1	5	16	Q6
Q2	6	15	Q5
D2	7	14	D5
D3	8	13	D4
Q3	9	12	Q4
GND	10	11	LATCH ENABLE

**FUNCTION TABLE**

Inputs			Output
Output Enable	Latch Enable	D	Q
L	H	H	H
L	H	L	L
L	L	X	No Change
H	X	X	Z

X = Don't Care  
 Z = High Impedance

**MAXIMUM RATINGS\***

Symbol	Parameter	Value	Unit
$V_{CC}$	DC Supply Voltage (Referenced to GND)	-0.5 to +7.0	V
$V_{IN}$	DC Input Voltage (Referenced to GND)	-1.5 to $V_{CC} + 1.5$	V
$V_{OUT}$	DC Output Voltage (Referenced to GND)	-0.5 to $V_{CC} + 0.5$	V
$I_{IN}$	DC Input Current, per Pin	$\pm 20$	mA
$I_{OUT}$	DC Output Current, per Pin	$\pm 35$	mA
$I_{CC}$	DC Supply Current, $V_{CC}$ and GND Pins	$\pm 75$	mA
$P_D$	Power Dissipation in Still Air, Plastic DIP+ SOIC Package+	750 500	mW
Tstg	Storage Temperature	-65 to +150	$^{\circ}\text{C}$
$T_L$	Lead Temperature, 1 mm from Case for 10 Seconds (Plastic DIP or SOIC Package)	260	$^{\circ}\text{C}$

\*Maximum Ratings are those values beyond which damage to the device may occur. Functional operation should be restricted to the Recommended Operating Conditions.

+Derating - Plastic DIP: - 10 mW/ $^{\circ}\text{C}$  from 65 $^{\circ}$  to 125 $^{\circ}\text{C}$

SOIC Package: : - 7 mW/ $^{\circ}\text{C}$  from 65 $^{\circ}$  to 125 $^{\circ}\text{C}$

**RECOMMENDED OPERATING CONDITIONS**

Symbol	Parameter	Min	Max	Unit
$V_{CC}$	DC Supply Voltage (Referenced to GND)	2.0	6.0	V
$V_{IN}, V_{OUT}$	DC Input Voltage, Output Voltage (Referenced to GND)	0	$V_{CC}$	V
$T_A$	Operating Temperature, All Package Types	-55	+125	$^{\circ}\text{C}$
$t_r, t_f$	Input Rise and Fall Time (Figure 1)			ns
	$V_{CC} = 2.0\text{ V}$	0	1000	
	$V_{CC} = 4.5\text{ V}$	0	500	
	$V_{CC} = 6.0\text{ V}$	0	400	

This device contains protection circuitry to guard against damage due to high static voltages or electric fields. However, precautions must be taken to avoid applications of any voltage higher than maximum rated voltages to this high-impedance circuit. For proper operation,  $V_{IN}$  and  $V_{OUT}$  should be constrained to the range  $\text{GND} \leq (V_{IN} \text{ or } V_{OUT}) \leq V_{CC}$ .

Unused inputs must always be tied to an appropriate logic voltage level (e.g., either GND or  $V_{CC}$ ). Unused outputs must be left open.

**DC ELECTRICAL CHARACTERISTICS** (Voltages Referenced to GND)

Symbol	Parameter	Test Conditions	V <sub>CC</sub> V	Guaranteed Limit			Unit
				25 °C to -55°C	≤85 °C	≤125 °C	
V <sub>IH</sub>	Minimum High-Level Input Voltage	V <sub>OUT</sub> =0.1 V or V <sub>CC</sub> -0.1 V  I <sub>OUT</sub>   ≤ 20 μA	2.0	1.5	1.5	1.5	V
			4.5	3.15	3.15	3.15	
			6.0	4.2	4.2	4.2	
V <sub>IL</sub>	Maximum Low - Level Input Voltage	V <sub>OUT</sub> =0.1 V or V <sub>CC</sub> -0.1 V  I <sub>OUT</sub>   ≤ 20 μA	2.0	0.5	0.5	0.5	V
			4.5	1.35	1.35	1.35	
			6.0	1.8	1.8	1.8	
V <sub>OH</sub>	Minimum High-Level Output Voltage	V <sub>IN</sub> =V <sub>IH</sub> or V <sub>IL</sub>  I <sub>OUT</sub>   ≤ 20 μA	2.0	1.9	1.9	1.9	V
			4.5	4.4	4.4	4.4	
		6.0	5.9	5.9	5.9		
		V <sub>IN</sub> =V <sub>IH</sub> or V <sub>IL</sub>  I <sub>OUT</sub>   ≤ 6.0 mA  I <sub>OUT</sub>   ≤ 7.8 mA	4.5	3.98	3.84	3.7	
6.0	5.48	5.34	5.2				
V <sub>OL</sub>	Maximum Low-Level Output Voltage	V <sub>IN</sub> = V <sub>IL</sub> or V <sub>IH</sub>  I <sub>OUT</sub>   ≤ 20 μA	2.0	0.1	0.1	0.1	V
			4.5	0.1	0.1	0.1	
		6.0	0.1	0.1	0.1		
		V <sub>IN</sub> = V <sub>IL</sub> or V <sub>IH</sub>  I <sub>OUT</sub>   ≤ 6.0 mA  I <sub>OUT</sub>   ≤ 7.8 mA	4.5	0.26	0.33	0.4	
6.0	0.26	0.33	0.4				
I <sub>IN</sub>	Maximum Input Leakage Current	V <sub>IN</sub> =V <sub>CC</sub> or GND	6.0	±0.1	±1.0	±1.0	μA
I <sub>OZ</sub>	Maximum Three-State Leakage Current	Output in High-Impedance State V <sub>IN</sub> = V <sub>IL</sub> or V <sub>IH</sub> V <sub>OUT</sub> =V <sub>CC</sub> or GND	6.0	±0.5	±5.0	±10	μA
I <sub>CC</sub>	Maximum Quiescent Supply Current (per Package)	V <sub>IN</sub> =V <sub>CC</sub> or GND I <sub>OUT</sub> =0μA	6.0	4.0	40	160	μA

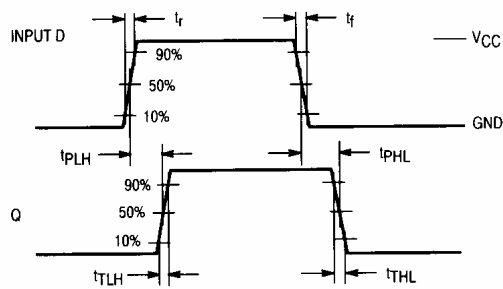
**AC ELECTRICAL CHARACTERISTICS** ( $C_L=50\text{pF}$ , Input  $t_r=t_f=6.0\text{ ns}$ )

Symbol	Parameter	V <sub>CC</sub> V	Guaranteed Limit			Unit
			25 °C to -55°C	≤85°C	≤125°C	
t <sub>PLH</sub> , t <sub>PHL</sub>	Maximum Propagation Delay, Input D to Q (Figures 1 and 5)	2.0	125	155	190	ns
		4.5	25	31	38	
		6.0	21	26	32	
t <sub>PLH</sub> , t <sub>PHL</sub>	Maximum Propagation Delay , Latch Enable to Q (Figures 2 and 5)	2.0	140	175	210	ns
		4.5	28	35	42	
		6.0	24	30	36	
t <sub>PLZ</sub> , t <sub>PHZ</sub>	Maximum Propagation Delay ,Output Enable to Q (Figures 3 and 6)	2.0	150	190	225	ns
		4.5	30	38	45	
		6.0	26	33	38	
t <sub>PZL</sub> , t <sub>PZH</sub>	Maximum Propagation Delay , Output Enable to Q (Figures 3 and 6)	2.0	150	190	225	ns
		4.5	30	38	45	
		6.0	26	33	38	
t <sub>TLH</sub> , t <sub>THL</sub>	Maximum Output Transition Time, Any Output (Figures 1 and 5)	2.0	60	75	90	ns
		4.5	12	15	18	
		6.0	10	13	15	
C <sub>IN</sub>	Maximum Input Capacitance	-	10	10	10	pF
C <sub>OUT</sub>	Maximum Three-State Output Capacitance (Output in High-Impedance State)	-	15	15	15	pF

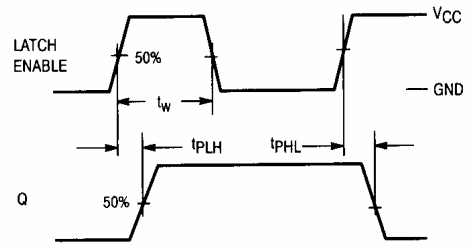
C <sub>PD</sub>	Power Dissipation Capacitance (Per Enabled Output)	Typical @25°C, V <sub>CC</sub> =5.0 V			pF
	Used to determine the no-load dynamic power consumption: $P_D=C_{PD}V_{CC}^2f+I_{CC}V_{CC}$	36			

**TIMING REQUIREMENTS** ( $C_L=50\text{pF}$ , Input  $t_r=t_f=6.0\text{ ns}$ )

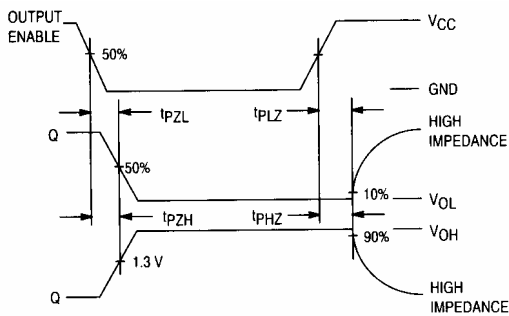
Symbol	Parameter	V <sub>CC</sub> V	Guaranteed Limit			Unit
			25 °C to -55°C	≤85°C	≤125°C	
t <sub>SU</sub>	Minimum Setup Time, Input D to Latch Enable (Figure 4)	2.0	25	30	40	ns
		4.5	5.0	6.0	8.0	
		6.0	5.0	6.0	7.0	
t <sub>H</sub>	Minimum Hold Time,Latch Enable to Input D (Figure 4)	2.0	5.0	5.0	5.0	ns
		4.5	5.0	5.0	5.0	
		6.0	5.0	5.0	5.0	
t <sub>w</sub>	Minimum Pulse Width, Latch Enable (Figure 2)	2.0	60	75	90	ns
		4.5	12	15	18	
		6.0	10	13	15	
t <sub>r</sub> , t <sub>f</sub>	Maximum Input Rise and Fall Times (Figure 1)	2.0	1000	1000	1000	ns
		4.5	500	500	500	
		6.0	400	400	400	



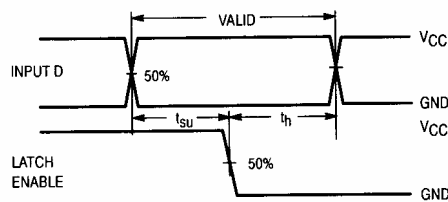
**Figure 1. Switching Waveforms**



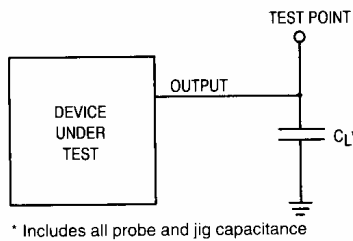
**Figure 2. Switching Waveforms**



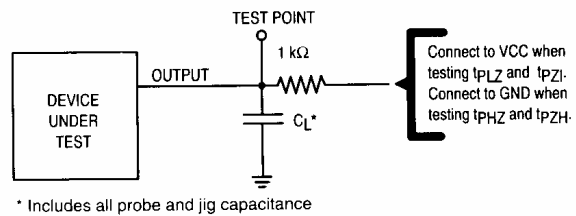
**Figure 3. Switching Waveforms**



**Figure 4. Switching Waveforms**

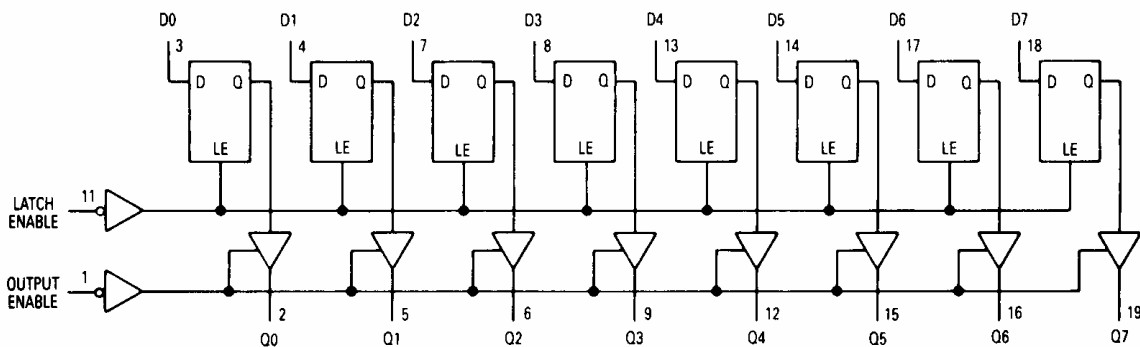


**Figure 5. Test Circuit**

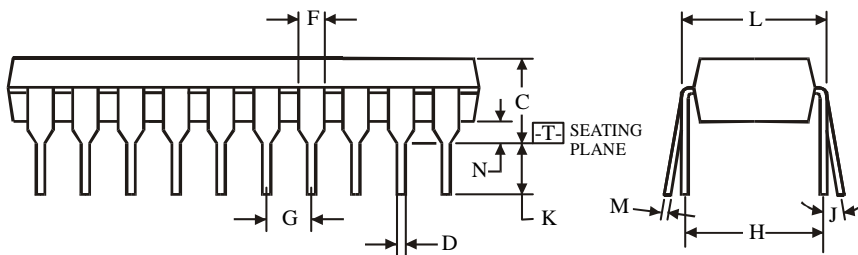
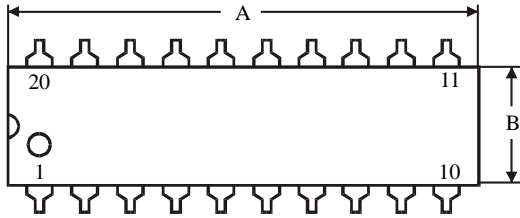
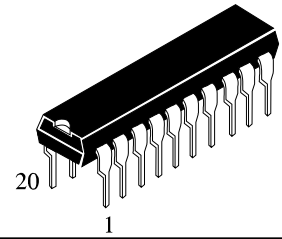


**Figure 6. Test Circuit**

**EXPANDED LOGIC DIAGRAM**



### N SUFFIX PLASTIC DIP (MS - 001AD)



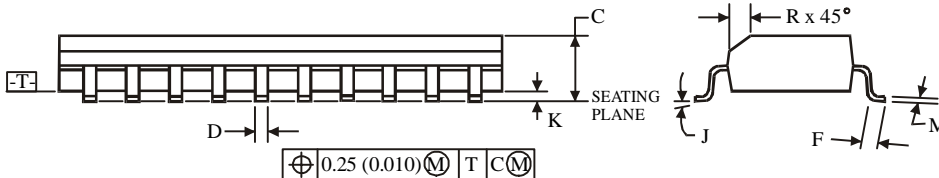
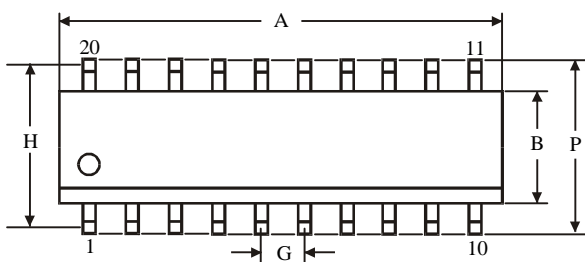
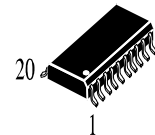
$\oplus 0.25 (0.010) \text{M} \text{T}$

#### NOTES:

- Dimensions "A", "B" do not include mold flash or protrusions.  
Maximum mold flash or protrusions 0.25 mm (0.010) per side.

Symbol	Dimension, mm	
	MIN	MAX
A	24.89	26.92
B	6.1	7.11
C		5.33
D	0.36	0.56
F	1.14	1.78
G	2.54	
H	7.62	
J	0°	10°
K	2.92	3.81
L	7.62	8.26
M	0.2	0.36
N	0.38	

### D SUFFIX SOIC (MS - 013AC)



$\oplus 0.25 (0.010) \text{M} \text{T} \text{CM}$

#### NOTES:

- Dimensions A and B do not include mold flash or protrusion.
- Maximum mold flash or protrusion 0.15 mm (0.006) per side for A; for B - 0.25 mm (0.010) per side.

Symbol	Dimension, mm	
	MIN	MAX
A	12.6	13
B	7.4	7.6
C	2.35	2.65
D	0.33	0.51
F	0.4	1.27
G	1.27	
H	9.53	
J	0°	8°
K	0.1	0.3
M	0.23	0.32
P	10	10.65
R	0.25	0.75