

# LINEAR INTEGRATED CIRCUIT

## VOICE SWITCHED SPEAKER PHONE CIRCUIT

**KL34018**

### DESCRIPTION

The KL34018 speaker-phone integrated circuit incorporates the necessary functions to produce a high quality hands-free speaker-phone system. The applications include household and office speaker-phones, intercom systems, hand free kit for mobile phones, and others

### FEATURES

- All necessary level detection and attenuation controls for a hand-free telephone included.
- Background noise level monitoring with long time constant.
- Background sound level compensation for transmit and receive levels as well as the background level.
- Wide operating dynamic range through signal compression.
- On-chip voltage regulators illuminate external regulators for lining operation.
- Power audio amplifier for typical 100mW output (into 25 ohms)with peak limiting for speaker to minimize distortion.
- Chip Select pin for active/stand by operation.
- Volume control function for external volume control.
- Standard 28-pin plastic DIP and SOP packages

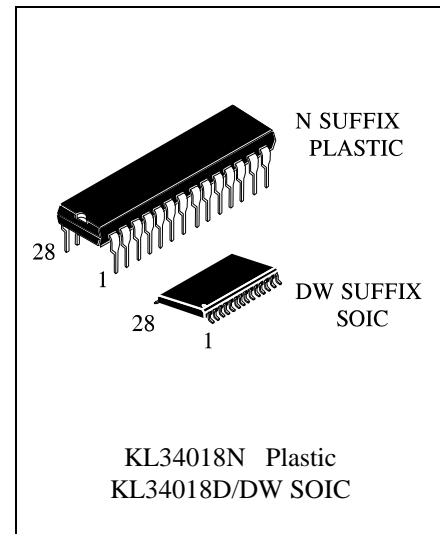

### ORDERING INFORMATION

Device	Operating Temperature Range	Package	Packing
KL34018N	T <sub>A</sub> = -25° to 85° C	DIP28	Tube
KL34018D		SOP28	Tube
KL34018DT		SOP28	Tape & Reel

### ABSOLUTE MAXIMUM RATINGS (Ta=25°C, Voltages referred to pin 22)

PARAMETER	VALUE	UNIT
V+ terminal Voltage (pin 16)	-1.0 to +12	V
c $\bar{s}$ (pin 18)	-1.0 to +12	V
Speaker amplifier Ground(pin 14)	-1.0 to +3.0	V
VLC(pin 24)	-1.0 to +Vcc	V
Storage temperature	-65 to +150	°C

\* Stresses beyond those listed under “absolute maximum ratings” may cause permanent damage to the device. These are stress ratings only and functional operation of the device at these or any other conditions beyond those indicated under “recommended operating conditions” is not implied. Exposure to absolute-maximum-rated conditions for extended periods may affect device reliability.

### RECOMMENDED OPERATION CONDITIONS

PARAMETER	VALUE	UNIT
V+ Terminal Voltage (pin 16)	+6.0 to +11	V
c $\bar{s}$ (pin 18)	0 to +11	V
Vcc (pin 20)	0 to 3.0	mA
VLC(pin 24)	0.55V <sub>B</sub> to V <sub>B</sub>	V
Receive Signal(pin 27)	0 to 250	mV <sub>rms</sub>
Microphone Signal(pin 9)	0 to 5.0	mV <sub>rms</sub>
Speaker Amplifier Ground (pin 14)	-10 to +10	mV <sub>dc</sub>
Ambient Temperature	-25 to +85	°C

### Internal Block Diagram

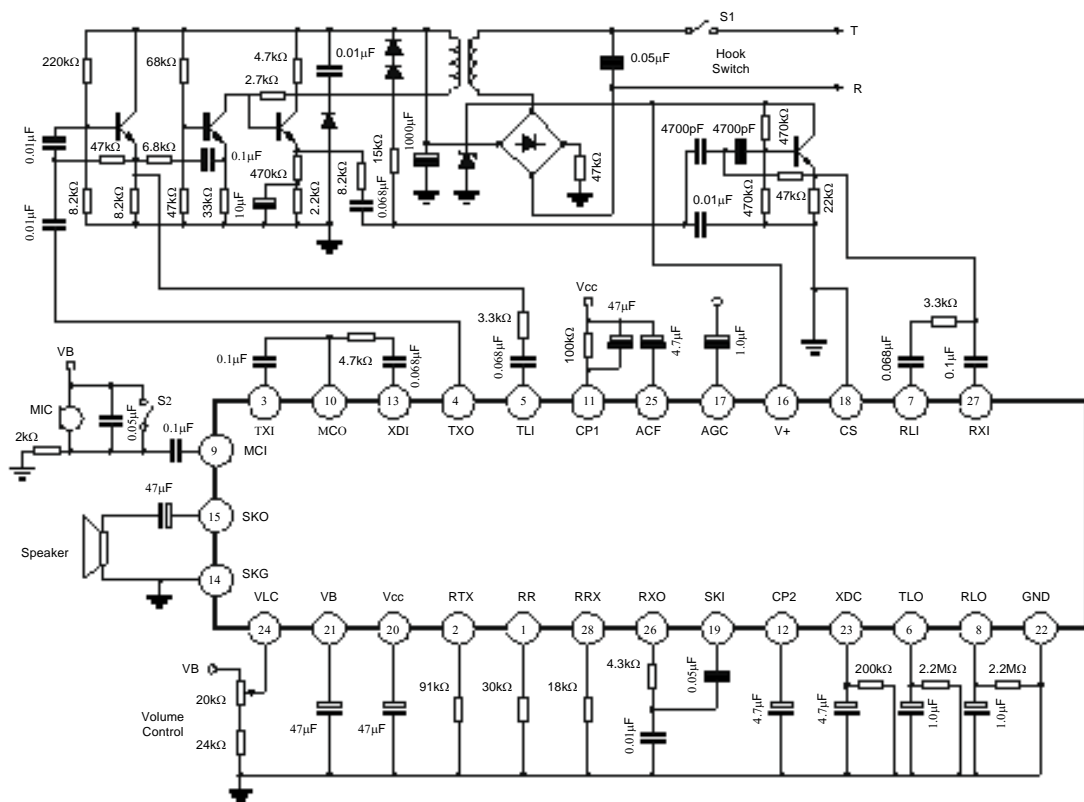
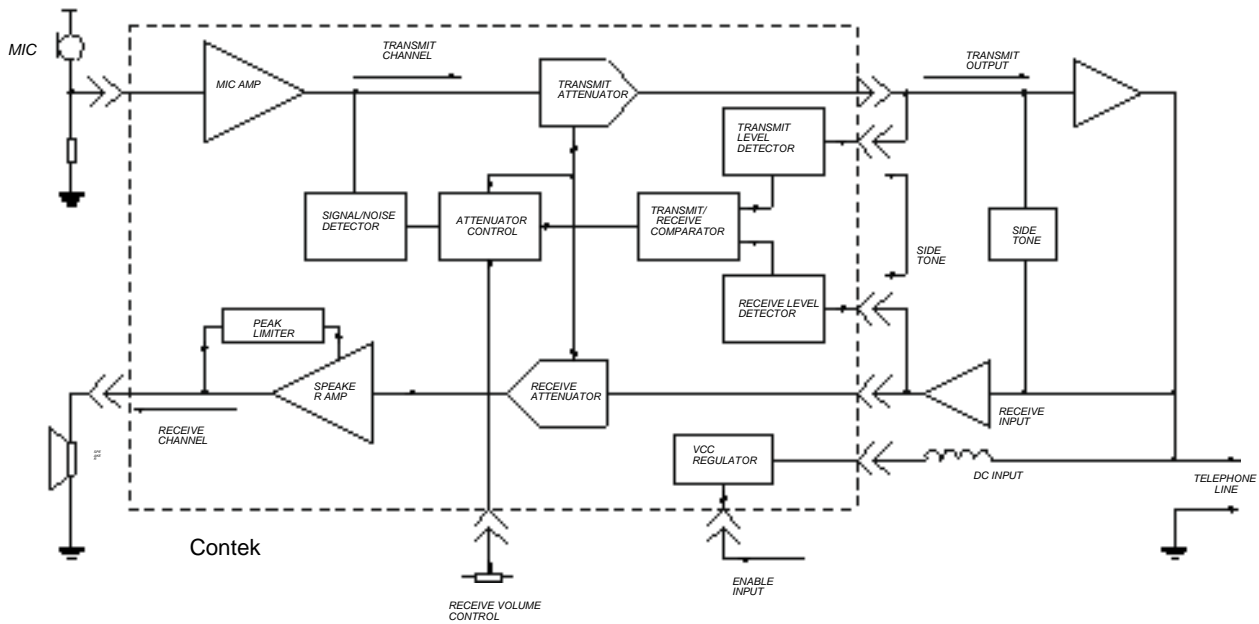

Fig 1 - Basic Line powered Speakerphone

## PIN CONFIGURATIONS

PIN	NAME	DESCRIPTION
1	RR	A resistor to ground provides a reference current for the transmit and receive attenuators
2	RTX	A resistor to ground determines the nominal gain of the transmit attenuator, the transmit channel inversely proportional to RTX resistance.
3	TXI	Input to the transmit attenuator. Input resistance is nominally 5.0k ohms.
4	TXO	Output of the transmit attenuator. The TXO output signal drives the input of transmit level detector as the external circuit which drivers the telephone line.
5	TLI	Input of the transmit level detector. An external resistor ac coupled to The TLI pin sets the detector. Decreasing this resistor increases the sensitivity to transmit channel signals.
6	TLO	Output of the transmit level detector. The external resistor and capacitor set the time the comparator hold the system in the transmit mode after speech ceases.
7	RLI	Input of the receive level detector. An external resistor ac coupled to The RLI pin sets the detector. Decreasing this resistor increases the sensitivity to receive channel signals
8	RLO	Output of the receive level detector. The external resistor and capacitor set the time the comparator hold the system in the receive mode after speech ceases
9	MCI	Microphone amplifier input. Input impedance is nominally 10k ohms and the dc bias voltage is approximately equal to VB
10	MCO	Microphone amplifier output. The MIC amp gain is internally set at 34dB(50V/V)
11	CP1	A parallel resistor and capacitor connected between this pin and VCC holds a voltage corresponding to the background noise level. The transmit detector compares the CP1 voltage with the speech signal at CP2.
12	CP2	A capacitor at this pin peak detects the speech signals for comparison with the background noise at CP1.
13	XDI	Input to the transmit detector system. The microphone amplifier output is ac coupled to the XDI through an external resistor
14	SKG	High current ground pin for the speaker amplifier output stage. The SKG voltage should be within 10mV of the ground voltage at pin 22
15	SKO	Speaker amplifier output. The SKO pin will source and sink up to 100mA when ac coupled to the speaker. The speaker amplifier gain is internally set at 34dB(50V/V).
16	V+	Input DC supply voltage. V+ can be powered from Tip and Ring if an ac decoupling inductor is used to prevent loading ac line signals. The required V+ voltage is 6.0V to 11V(7.5V nominal) at 7.0mA
17	AGC	A capacitor from this pin to VB stabilizes the speaker amplifier gain control loop, and additionally controls the attack and decay time of this circuit. The gain control loop limits the speaker amplifier to prevent clipping at SKO. The internal resistance at AGC pin is nominally 110k ohms.
18	$\overline{CS}$	Digital chip select input. When at a logic "0" (<0.7V) the VCC regulator is enabled. When at a logic "1" (>1.6V), the chip is in the standby mode drawing 0.5mA. An open $\overline{CS}$ pin is a logic "0". Input Impedance is nominally 140k ohms. The input voltage should not exceed 11V
19	SKI	Input to the speaker amplifier. Input impedance is nominally 20k ohms
20	VCC	A 5.4V regulated output which powers all circuits except the speaker amplifier output stage
21	VB	An output voltage equal to approximately VCC/2 which series as an analog ground for the speakerphone system. Up to 1.5mA of external load current may be sourced from VB. Output impedance is 250 ohms. A filter capacitor is required
22	GND	Ground pin for the IC(except the speaker amplifier)
23	XDC	Transmit detector output. A resistor and capacitor at this pin hold the system in the transmit mode during pauses between words or phrases. When the XDC pin voltage decays to ground, the attenuators switch from the transmit mode to idle mode. The internal resistor at XDC is nominally 2.6k ohms(see figure 1)
24	VLC	Volume control input>connecting this pin to the slider of a variable resistor provides receive mode volume control. The VLC pin voltage should be less than or equal to VB
25	ACF	Attenuator control filter. A capacitor connected to this pin reduces noise transient as the attenuator control switches level of attenuation
26	RXO	Output of the receive attenuator. Normally this pin is ac coupled to the input of the speaker amplifier
27	RXI	Input of the receive attenuator. Input impedance is nominally is 5.0k ohms
28	RRX	A resistor to ground determines the nominal gain of the receive attenuator. The receive channel gain is directly proportional to the RRX resistance

**ELECTRICAL CHARACTERISTICS** (referred to fig. 1)

PARAMETER	SYMBOL	MIN	TYP	MAX	UNIT
<b>SUPPLY VOLTAGES</b>					
V+ Supply Current V+=11V, Pin 18=0.7V V+=11V, Pin 18=1.6V	IV+			9.0 800	mA A
VCC Voltage (V+=7.5V) Line Regulation (6.5V<V+<11V) Output Resistance (ICC=3mA)	Vcc VccLN RoVcc Vccsat	4.9	5.4 65 6.0 80	5.9 150 20 300	Vdc MV ohms mV
VB Voltage(V+=7.5V) Output Resistance (I B=1.7mA)	Vb Rovb	2.5	2.9 250	3.3	Vdc ohms
<b>ATTENUATORS</b>					
Receive Attenuator Gain (1.0kHz) Rx Mode, Pin 24= VB, Pin 27 = 250Mvrms Range (Rx to Tx Modes) Idle Mode, Pin 27= 250mVrms	GRX GRX GRI	2.0 40 -20	6.0 44 -16	10 48 -12	dB dB dB
RXO Voltage (Rx Mode)	VRXO	1.8	2.3	3.2	mV
Delta RXO Voltage (Switch from Rx to Tx Mode)	VRXO			100	mV
RXO Sink Current (Rx mode)	IRXOL	75			A
TXO Source Current (Tx mode)	ITXOH	1.0		3.0	mA
TXO Input Resistance	RTXI	3.5	5.0	8.0	k
ACF Voltage (VCC-Pin 25 Voltage) Rx Mode Tx Mode Idle Mode	VACF		150 6.0 75		mV mV mV
<b>SPEAKER AMPLIFIER</b>					
Speaker Amp Gain (pin 19 = 20mVrms)	GSPK	33	34	35	dB
SKI Input Resistance	RSKI	15	22	37	k
SKO Voltage ( Pin 19 =Cap couple to GND)	VSKO	2.4	3.0	3.6	Vdc
SKO High Voltage ( Pin 19 = 0.1V, -100mA Load at Pin 15)	VSKOH	5.5			Vdc
SKO Low Voltage (pin 19=0.1V, +100mA Load at Pin 15)	VSKOL			600	mV
<b>MICROPHONE AMPLIFIER</b>					
Microphone Amp Gain ( Pin 9 = 10mVrms,1KHz)	GMCI	32.5	34	35	dB
Microphone Amp Input Resistance	RMCI	6.5	10	16	k
<b>LOGAMPS</b>					
RLO Leakage Current (Pin 8 = VB+1.0V)	ILKRLO			2.0	A
TLO Leakage Current (Pin 6 = VB+1.0V)	ILKTLO			2.0	A
Transmit-Receive Switching Threshold (Ratio of ITLI to IRLI - at 20 A - to Switch Tx-Rx Comparator)	ITH	25			

**ELECTRICAL CHARACTERISTICS** (continued)

PARAMETER	SYMBOL	MIN	TYP	MAX	UNIT
<b>TRANSMIT DETECTOR</b>					
XDC Voltage Idle Mode Tx Mode	VXDC		0 4.0		Vdc Vdc
CP2 Current Source	ICP2	5.0	10	13	A
Distortion Rx Mode RXI to SKO (pin 27 = 10mVrms,1KHz)	RXD		1.5		%
Tx Mode MCI to TXO (Pin 9 = 5mVrms,1KHz)	TXD		2.0		%

Note 1:  $V_{+}=7.5V$ ,  $\bar{c}s}=0.7V$  except where noted.

Note 2: Rx mode: pin7=-100 A, pin5=+100 A, except where noted

Tx mode: pin 5,13=-100 A, pin 7=+100 A, pin 11=0V. Idle mode: Pin 5=-100A, pin 7,13=+100 A

Note 3: Current into a pin designed as + ,current out of a pin designed -;

Note 4: Voltage referred to pin 22,  $T_{amb}=25^{\circ}C$

**TEMPERATURE CHARACTERISTICS** (-20 TO +60 °C )

PARAMETER	PIN	TYP CHANGE	UNIT
V+ Supply Current ( V+ 11V,Pin 18 = 0.7V )	16	-0.2	%/ C
V+ Supply Current(V+ 11V,Pin 18 = 1.6V )	16	-0.4	%/ C
VCC Voltage( V+ = 7.5V )	20	+0.1	%/ C
Attenuator Gain ( Max and Min Setting )		+0.003	dB/ C
Delta RXO,TXO Voltage	4,26	+0.24	%/ C
Speaker AMP Gain	15,19	+0.001	dB/ C
Microphone AMP Gain	9,10	+0.4	dB/ C
Microphone Amp Input Resistance	9	+0.4	%/ C
Tx-Rx Switching Threshold (20 A)	5,7	+0.2	nA/ C

## FUNCTION DESCRIPTION

### ATTENUATORS

The transmit and receive attenuators are complementary in function, i.e., when one is at maximum gain the other is at maximum attenuation, and vice versa. They are never both on or both off. Their main purpose is to control the transmit and receive paths to provide the half-duplex operation required of a speakerphone. The attenuators are controlled solely by the voltage at the ACF pin (Pin 25). The ACF voltage is provided by the Attenuator Control block, which receives 3 inputs: a) the Rx-Tx Comparator, b) the Transmit Detector Comparator, and c) the Volume Control. The response of the attenuators is based on the difference of the ACF voltage from VCC, and therefore a simple method for monitoring the circuit operation is to monitor this voltage difference (referred to as  $\Delta V_{acf}$ ). If  $\Delta V_{acf}$  is approximately 6 millivolts the transmit attenuator is fully on and the receive attenuator is fully off (transmit mode). If  $\Delta V_{acf}$  is approximately 150 millivolts the circuit is in the receive mode. If  $\Delta V_{acf}$  is approximately 75 millivolts, the circuit is in the idle mode, and the two attenuators are at gain settings approximately half way (in dB) between their fully on and fully off positions.

The maximum gain and attenuation values are determined by the three resistors RR, RTX, and RRX (Refer to Figures 2, 3 and 4). RR affects both attenuators according to its value RELATIVE to RTX and RRX, which is why Figure 4 indicates the variations versus the ratio of the other resistors to RR. (GRX and GTX are the maximum gains, and ARX and ATX are the maximum attenuations). RTX affects the gain and attenuation of only the transmit attenuator according to the curves of Figure 2, while RRX affects only the receive attenuator according to Figure 3. As can be seen from the figures, the gain difference (from on to off) is a reasonably constant 45 dB until the upper gain limit is approached. A value of 30 k is recommended for RR as a starting point, and then RTX and RRX selected to suit the particular design goals.

The input impedance of the attenuators (at TXI and RXI) is typically 5.0 k $\Omega$ , and the maximum input signal which will not cause output distortion is 250 mVrms (707 mVp-p). The 4300 ohm resistor and 0.01 pF capacitor at RXO (in Figure 1) filters out high frequency components in the receive path. This helps minimize high frequency acoustic feedback problems which may occur if the filter were not present. The filter's insertion loss is 1.5 dB at 1.0 kHz. The outputs of the attenuators are inverted from their inputs. Referring to the attenuator

Tx-Rx Comp	Transmit Det Comp	Volume Control	$\Delta V_{acf}$	Mode
Transmit	Transmit	No Effect	6.0 mV	Transmit
Transmit	Idle	No Effect	75 mV	Idle
Receive	Transmit	Affects $\Delta V_{acf}$	50-150 mV	Receive
Receive	Idle	Affects $\Delta V_{acf}$	50-150 mV	Receive

As can be seen from the truth table, the Tx-Rx comparator dominates. The Transmit Detector Comparator is effective only in the transmit mode, and the Volume Control is effective only in the receive mode.

The Tx-Rx comparator is in the transmit position when there is sufficient transmit signal present over and above any receive signal. The Transmit Detector Comparator then determines whether the transmit signal is a result of background noise (a relatively stable signal), or speech which consists of bursts. If the signal is due to background noise, the attenuators will be put into the idle mode ( $\Delta V_{acf} = 75$  mV). If the signal consists of speech, the attenuators will be switched to the transmit mode ( $\Delta V_{acf} = 6.0$  mV.) A further explanation of this function will be found in the section on the Transmit Detector Circuit.

The Tx-Rx comparator is in the receive position when there is sufficient receive signal to overcome the background noise AND any speech signals. The  $\Delta V_{acf}$  voltage will now be 150 mV IF the volume control is at the maximum position, i.e. VLC (Pin 24) = VB. IF VLC is less than VB, the gain of the receive attenuator, and the attenuation of the transmit attenuator, will vary in a complementary manner as shown in Figure 5. It can be seen that at the minimum recommended operating level (VLC = 0.55 VB) the gain of the transmit attenuator is actually greater than that of the receive attenuator. The effect of varying VLC is to vary  $\Delta V_{acf}$ , with a resulting variation in the gains of the attenuators. Figure 6 shows the gain variations with  $\Delta V_{acf}$ .

The capacitor at ACF (Pin 25) smooths the transition between operating modes. This keeps down any "clicks" in the speaker or transmit signal when the ACF voltage switches.

The gain separation of the two attenuators can be reduced from the typical 45 dB by adding a resistor between Pins 20 (VCC) and 25 (ACF). The effect is a reduction of the maximum  $\Delta V_{acf}$  voltage in the receive mode, while not affecting  $\Delta V_{acf}$  in the transmit mode. As an example, adding a 12 k $\Omega$  resistor will reduce  $\Delta V_{acf}$  by approximately 15 mV (to 135 mV), decrease the gain of the receive attenuator by approximately 5.0 dB, and increase the gain of the transmit attenuator by a

control block, the AVacf voltage at its output is determined by three inputs. The relationship of the inputs and output is summarized in the following truth table:

## LOG AMPLIFIERS

### (Transmit and Receive Level Detectors)

The log amps monitor the levels of the transmit and receive signals, so as to tell the Tx-Rx comparator which mode should be in effect. The input signals are applied to the amplifiers (at TLI and RLI) through AC coupling capacitors and current limiting resistors. The value of these components determines the sensitivity of the respective amplifiers, and has an effect on the switching times between transmit and receive modes. The feedback elements for the amplifiers are back-to-back diodes which provide a logarithmic gain curve, thus allowing operation over a wide range of signal levels. The outputs of the amplifiers are rectified, having a quick rise time and a slow decay time. The rise time is determined primarily by the external capacitor (at TLO or RLO) and an internal 500 ohm resistor, and is on the order of a fraction of a millisecond. The decay time is determined by the external resistor and capacitor, and is on the order of a fraction of a second. The switching time is not fixed, but depends on the relative values of the transmit and receive signals, as well as these external components. Figure 7 indicates the dc transfer characteristics of the log amps, and Figure 8 indicates the transfer characteristics with respect to an ac input signal. The dc level at TLI, RLI, TLO, and RLO is approximately VB.

The Tx-Rx comparator responds to the voltages at TLO and RLO, which in turn are functions of the currents sourced out of TLI and RLI, respectively. If an offset at the comparator input is desired, e.g., to prevent noise from switching the system, or to give preference to either the transmit or receive channel, this may be achieved by biasing the appropriate input (TLI or RLI). A resistor to ground will cause a DC current to flow out of that input, thus forcing the output of that amplifier to be biased slightly higher than normal. This amplifier then becomes the preferred one in the system operation. Resistor values from 500 k to 10 M ohms are recommended for this purpose.

### SPEAKER AMPLIFIER

The speaker amplifier has a fixed gain of 34 dB (50 VN), and is noninverting. The input impedance is nominally 22 k $\Omega$  as long as the output signal is below that required to activate the Peak Limiter. Figure 9 indicates the typical output swing available at SKO (Pin 15). Since the output current capability is 100 mA, the lower curve is limited to a 5.0 volt swing. The output impedance depends on the output signal level and is relatively low as long as the signal level is not near the maximum limits. At 3 volts p-p the output impedance is

similar amount. If the circuit requires the receive attenuator gain to be +6.0 dB in the receive mode, RRX must be adjusted (to - 27 k) to re-establish this value. This change will also increase the receive attenuator gain in the transmit mode by a similar amount. The resistor at TLI may also require changing to reset the sensitivity of the transmit level detector.

effect is that of a gain reduction caused by a reduction of the input impedance (at SKI) to a value not less than 2.0 k $\Omega$ .

The capacitor at Pin 17 (AGC) determines the response time of the peak limiter circuit. When a large input signal is applied to SKI, the voltage at AGC (Pin 17) will drop quickly as a current source is applied to the external capacitor. When the large input signal is reduced, the current source is turned off, and an internal 110 k $\Omega$  resistor discharges the capacitor so the voltage at AGC can return to its normal value (1.9 Vdc). The capacitor additionally stabilizes the peak limiting feedback loop.

If there is a need to mute the speaker amplifier without disabling the rest of the circuit, this may be accomplished by connecting a resistor from the AGC pin to ground. A 100 k $\Omega$  resistor will reduce the gain by 34 dB (0 dB from SKI to SKO), and a 10 k resistor will reduce the gain by almost 50 dB.

### TRANSMIT DETECTOR CIRCUIT

The transmit detector circuit, also known as the background noise monitor, distinguishes speech (which consists of bursts) from the background noise (a relatively constant signal). It does this by storing a voltage level, representative of the average background noise, in the capacitor at CP1 (Pin 11). The resistor and capacitor at this pin have a time constant of approximately 5 seconds (in Figure 1). The voltage at Pin 11 is applied to the inverting input of the Transmit Detector Comparator. In the absence of speech signals, the noninverting input receives the same voltage level minus an offset of 36 mV. In this condition, the output of the comparator will be low, the output transistor turned off, and the voltage at XDC (Pin 23) will be at ground. If the Tx-Rx comparator is in the transmit position, the attenuators will be in the idle mode (AVacf=75 mV). When speech is presented to the microphone, the signal burst appearing at XDI reaches the noninverting input of the transmit detector comparator before the voltage at the inverting input can change, causing the output to switch high, driving the voltage at XDC up to approximately 4 volts. This high level causes the attenuator control block to switch the attenuators from the idle mode to the transmit mode (assuming the Tx-Rx comparator is in the transmit mode). As long as the speech continues to arrive, and is maintained at a level above the background, the voltage at XDC will be maintained at a high level, and the circuit will remain in the transmit mode. The time constant of the components at XDC will determine how much time the circuit requires to return to the idle mode after the cessation of microphone speech signals, such as

<0.5 ohms, and at 4.5 volts p-p it is <3 ohms. The output is short circuit protected at approximately 300 mA.

When the amplifier is overdriven, the peak limiter causes a portion of the input signal to be shunted to ground, in order to maintain a constant output level. The greater the change at CP2). Increasing the resistor, or lowering the capacitor, will reduce the response at these pins. The first amplifier (between XDI and CP2) is logarithmic in order that this circuit be able to handle a wide range of signal levels (or in other words, it responds equally well to people who talk quietly and to people who shout). Figure 7 indicates the dc transfer characteristics of the log amp.

Figure 11 indicates the response at Pins 11, 12, and 23 to a varying signal at the microphone. The series of events in Figure 11 is as follows:

1) CP2 (Pin 12) follows the peaks of the speech signals, and decays at a rate determined by the 10pA current source and the capacitor at this pin.

2) CP1 (Pin 11) increases at a rate determined by the RC at this pin after CP2 has made a positive transition. It will follow the decay pattern of CP2.

3) The noninverting input of the Transmit Detector Comparator follows CP2, gained up by 2.7, and reduced by an offset of 36 mV. This voltage, compared to CP1, determines the output of the comparator.

4) XDC (Pin 23) will rise quickly to 4 Vdc in response to a positive transition at CP2, but will decay at a rate determined by the RC at this pin. When XDC is above 3.25 Vdc, the circuit will be in the transmit mode. As it decays towards ground, the attenuators are taken to the idle mode.

### MICROPHONE AMPLIFIER

The microphone amplifier is noninverting, has an internal gain of 34 dB (50 VN), and a nominal input impedance of 10 kR. The output impedance is typically <15 ohms. The maximum p-p voltage swing available at the output is approximately 2.0 volts less than VCC, which is substantially more than what is required in-most applications.

The input at MCI (Pin 9) should be ac coupled to the microphone so as to not upset the bias voltage. Generally, microphone sensitivity may be adjusted by varying the 2 k microphone bias resistor, rather than by attempting to vary the gain of the amplifier.

### POWER SUPPLY

The voltage supply for the KL34018 at V+ (Pin 16) should be in the range of 6.0 to 11 volts, although the supply. The required supply current, with no signal to the speaker, is shown in Figure 12. The upper curve indicates the normal operating current when - Chip Select (Pin 18) is at a Logic "0". Figure 13 indicates the average dc current required when supplying various power levels to a 25 ohm speaker. Figure 13 also indicates the minimum supply voltage required to provide the indicated power levels. The peak in the power supply current at 5.0-5.4 volts occurs as the VCC

occurs during the normal pauses in speech.

The series resistor and capacitor at XDI (Pin 13) determine the sensitivity of the transmit detector circuit. Figure 10 indicates the change in DC voltage levels at CP2 and CP1 in response to a steady state sine wave applied at the input of the 0.068 pF capacitor and 4700 ohm resistor (the voltage change at CP1 is 2.7 times variation at V+ caused by the required speaker current flowing through this pin can cause a low frequency oscillation. The result is usually that the circuit will cut the speaker signal on and off at the rate of a few hertz. Experiments have shown that only a few inches of wire between the supply and the IC can cause the problem if the filter capacitor is not physically adjacent to the IC. It is equally imperative that both ground pins [Pins 14 and 22) have a low loss connection to the power supply ground.

### VCC

VCC (Pin 20) is a regulated output voltage of 5.4 volts, +I - 0.5 V. Regulation will be maintained as long as V + is (typically) 80 mV greater than the regulated value of VCC. Up to 3 milliamps can be sourced from this supply for external use. The output impedance is <20 ohms.

The 47 pF capacitor indicated for connection to Pin 20 is essential for stability reasons. It must be located adjacent to the IC.

If the circuit is deselected (see section on Chip Select), the VCC voltage will go to 0 volts.

If the KL34018 is to be powered from a regulated supply (not the Tip and Ring lines) of less than 6.5 volts, the configuration of Figure 14 may be used so as to ensure that VCC is regulated. The regulated voltage is applied to both V+ and VCC, with CS held at a Logic "1" so as to turn off the internal regulator (the Chip Select function is not available when the circuit is used in this manner). Figure 15 indicates the supply current used by this configuration, with no signal at the speaker. When a signal is sent to the speaker, the curves of Figure 13 apply.

### VB

VB is a regulated output voltage with a nominal value of 2.9 volts, +I-0.4 volts. It is derived from VCC and tracks it, holding a value of approximately 54% of VCC. 1.5 milliamps can be sourced from this supply at a typical output impedance of 250 ohms.

The 47 pF capacitor indicated for connection to the VB pin is required for stability reasons, and must be adjacent to the IC.

If the circuit is deselected (see section on Chip Select), the VB voltage will go to 0 volts. circuit will operate down to 4.0 volts. The voltage can be supplied either from Tip and Ring, or from a separate

### CHIP SELECT

The Chip Select pin (Pin 18) allows the chip to be shown in Figure 12. The input resistance at Pin 18 is powered down anytime its functions are not required.



circuit comes into regulation.

It is imperative that the V+ supply (Pin 16) be a good ac ground for stability reasons. If this pin is not well filtered (by a 1000 pF capacitor AT THE IC), any

>75 kΩ. The VCC and VB regulated voltages go to 0.0 A Logic "1" level in the range of 1.6 V to 11 V deselects when the chip is deselected. Leaving Pin 18 open is the chip, and the resulting supply current (at V+) is equivalent to a Logic "0" (chip enabled).

FIGURE 2 — TRANSMIT ATTENUATOR versus RTX

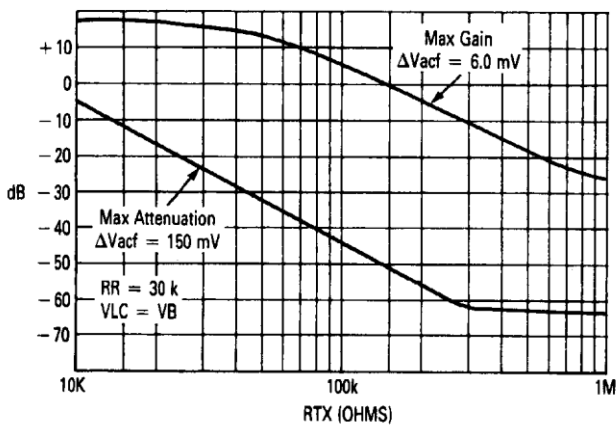
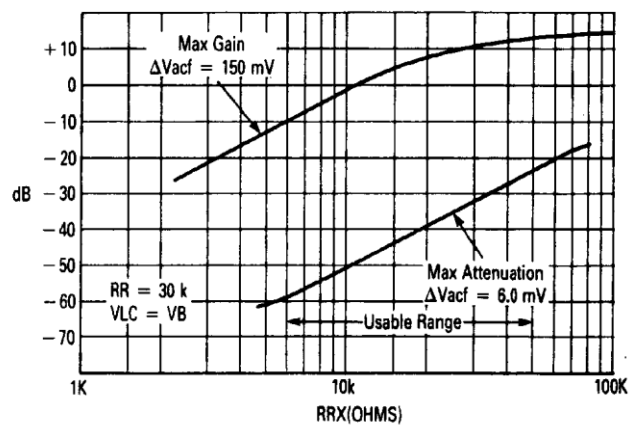
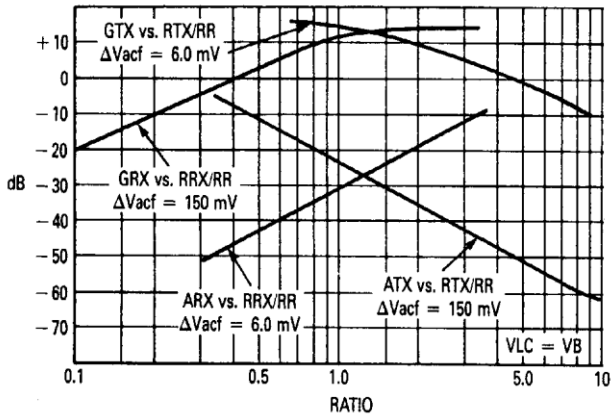

FIGURE 3 — RECEIVE ATTENUATOR versus RRX



**FIGURE 4 — GAIN AND ATTENUATION versus RESISTOR RATIOS**



**FIGURE 5 — ATTENUATOR GAIN versus VLC**

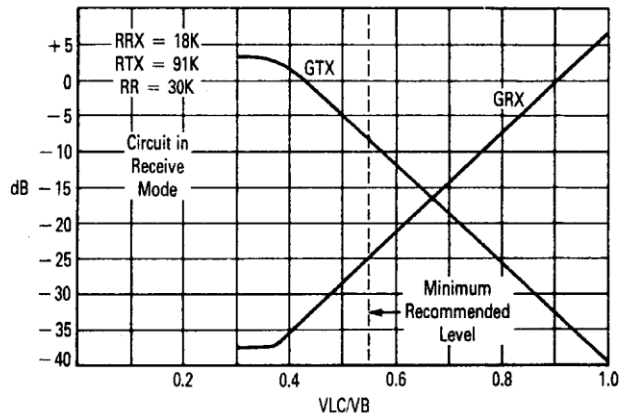

**FIGURE 6 — ATTENUATOR GAIN versus ΔVacf**

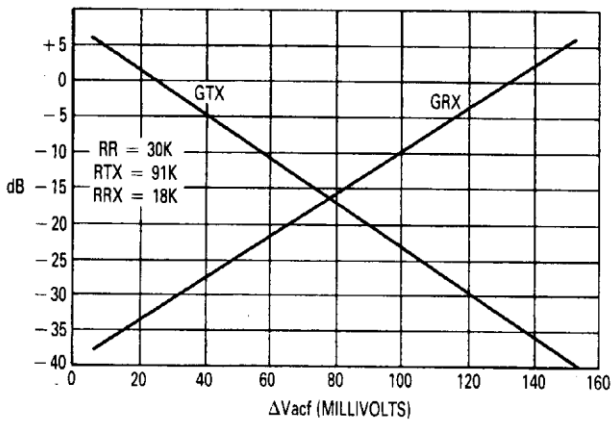

**FIGURE 7 — LOG AMP TRANSFER CHARACTERISTICS**

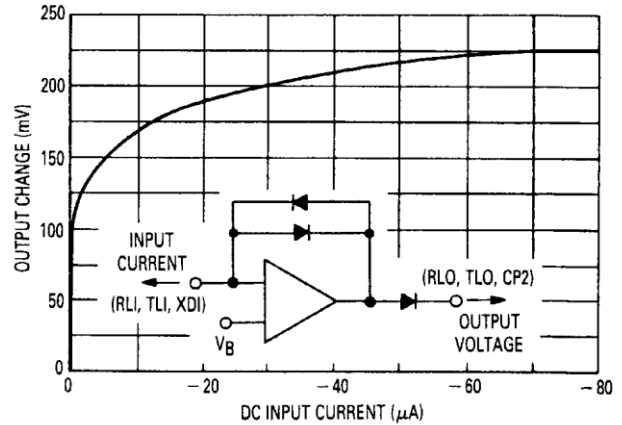

**FIGURE 8 — LOG AMP TRANSFER CHARACTERISTICS**

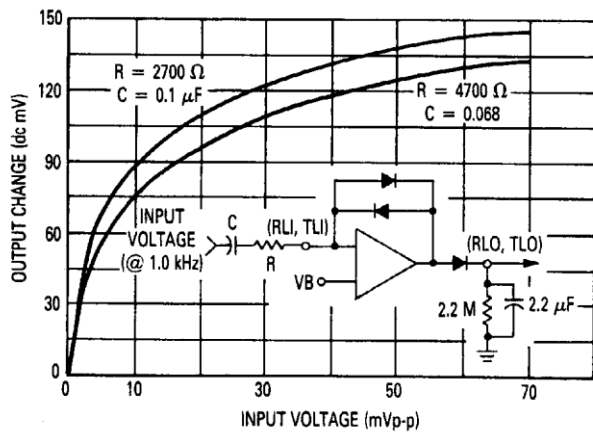

**FIGURE 9 — SPEAKER AMP OUTPUT versus SUPPLY VOLTAGE**

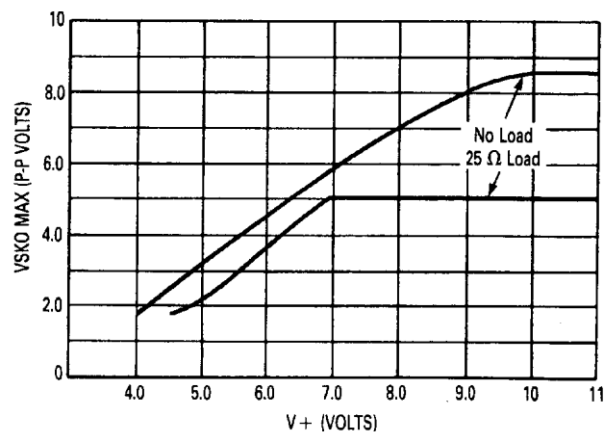

FIGURE 10 — RESPONSE AT CP2 AND CP1

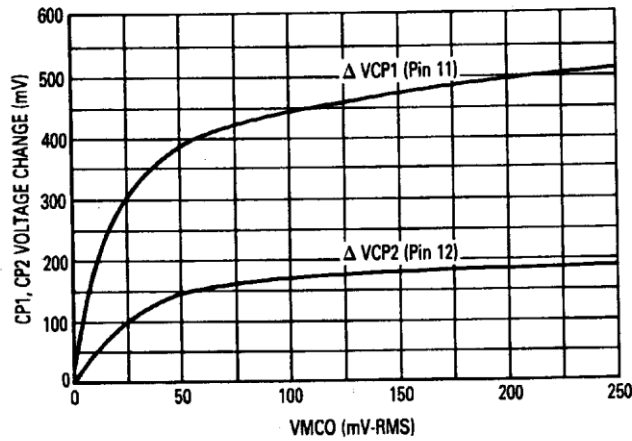

FIGURE 11 — TRANSMIT DETECTOR OPERATION

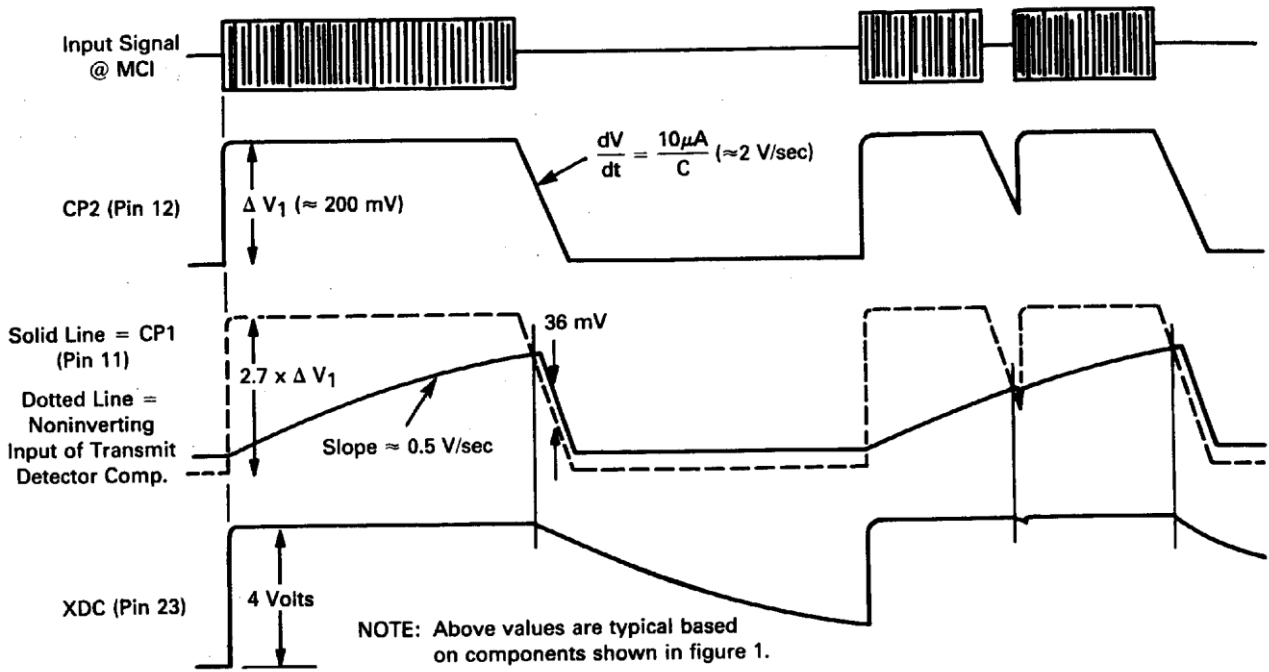

FIGURE 12 — SUPPLY CURRENT versus SUPPLY VOLTAGE

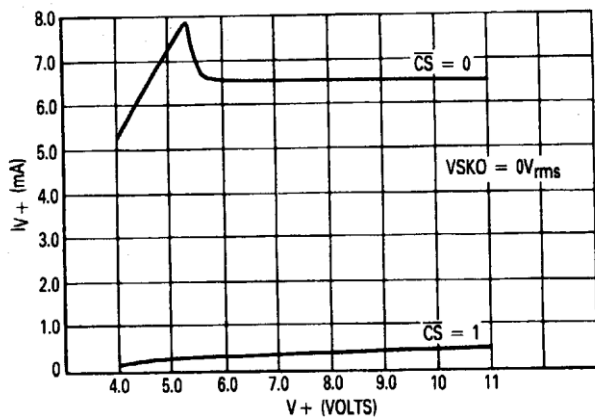

FIGURE 13 — SUPPLY CURRENT versus SUPPLY VOLTAGE versus SPEAKER POWER

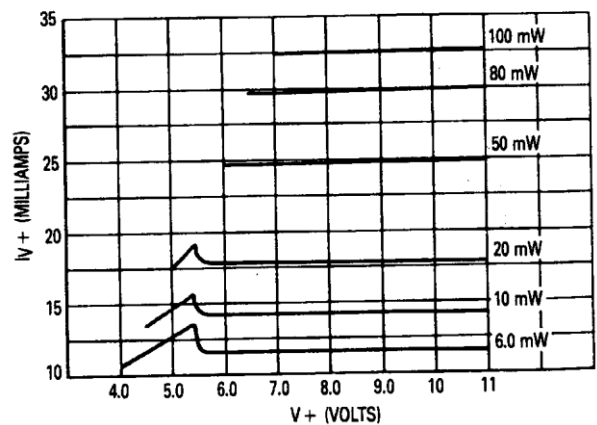

FIGURE 14 — ALTERNATE POWER SUPPLY CONFIGURATION

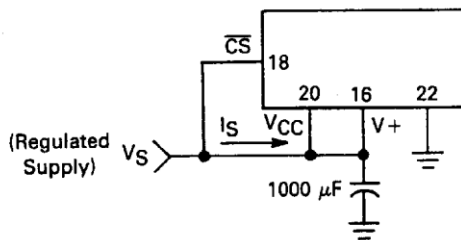
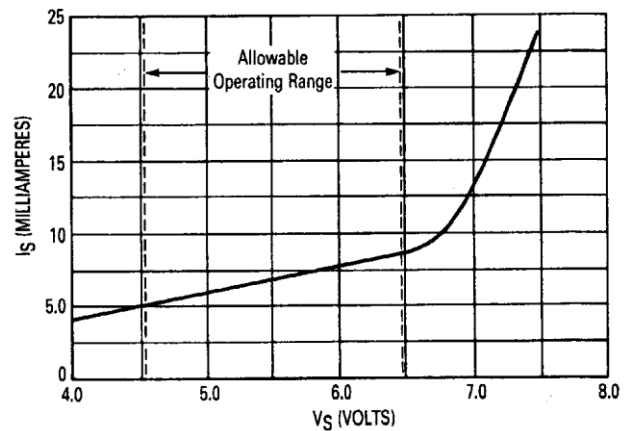

FIGURE 15 — SUPPLY CURRENT versus SUPPLY VOLTAGE (SEE FIGURE 14)



**SWITCHING TIME**

The switching times of the speakerphone circuit depend not only on the various external components, but also on the operating condition of the circuit at the time a change is to take effect. For example, the switching time from idle to transmit is generally quicker than the switching time from receive to transmit (or transmit to receive).

The components which most significantly affect the timing between the transmit and receive modes are those at Pins 5 (transmit turn-on), 6 (transmit turn-off), 7 (receive turn-on), and 8 (receive turn-off). These four timing functions are not independent, but interact since the Tx-Rx comparator operates on a RELATIVE Tx-Rx comparison, rather than on absolute values. The components at Pins 11, 12, 13, and 23 affect the timing from the transmit to the idle mode. Timing from the idle mode to transmit mode is relatively quick (due to the quick charging of the various capacitors), and is not greatly affected by the component values. Pins 5-8 do not affect the idle-to-transmit timing since the Tx-Rx comparator must already be in the transmit mode for this to occur.

milliseconds, and repeated every 1 second, is applied to MCI (Trace #1). Trace #2 is the output at TXO, and is approximately 650 mVp-p at its maximum. Trace #4 is the output at RXO, and is approximately 2.2 mVp-p at its maximum. The time to switch from the receive mode to the transmit mode is approximately 40 ms, as indicated by the time required for TXO to turn on, and for RXO to turn off. After the signal at MCI is shut off, the switching time back to the receive mode is approximately 210 ms.

In Figure 17, a continuous signal of 7.6 mVp-p is applied to MCI (Trace #1), and a repetitive burst signal of 100 mVp-p is applied to RXI (Trace #3), lasting approximately 120 ms, and repeated every 1 second.

The following table provides a summary of the effect on the switching time of the various components, including the volume control :

Additionally, the following should be noted:

- 1) The RCs at Pins 5 and 7 have a dual function in that they affect the sensitivity of the respective log amplifiers, or in other words, how loud the speech must be in order to gain control of the speakerphone circuit.
- 2) The RC at Pin 13 also has a dual function in that it determines the sensitivity of the transmit detector circuit.
- 3) The volume control affects the switching speed, and the relative response to transmit signals, in the following manner: When the circuit is in the receive mode, reducing the volume control setting increases the signal at TXO, and consequently the signal to the TLI pin. Therefore a given signal at TXI will switch the circuit into the transmit mode quicker at low volume settings.

The photographs of Figures 16 and 17 indicate experimentally obtained switching response times for the circuit of Figure 1. In Figure 16, the circuit is provided a continuous receive signal of 1.1 mVp-p at RXI (trace #3). A repetitive burst signal of 7.2 mVp-p, lasting 120

Trace #2 is the output at TXO and is approximately 90 mVp-p at its maximum, and Trace #4 indicates the output at RXO, and is approximately 150 mVp-p at its maximum. In this sequence, the circuit switches between the idle and receive modes. The time required to switch from idle to receive is approximately 70 ms, as indicated by the first part of Traces 2 and 4. After the receive signal is shut off, the time to switch back to the idle mode is approximately 100 ms.

All of the above mentioned times will change significantly by varying the amplitude of the input signals, as well as by varying the external components.

<b>Components</b>	<b>Tx to Rx</b>	<b>Rx to Tx</b>	<b>Tx to Idle</b>
RC @ Pin 5	Moderate	Significant	No effect
RC @ Pin 6	Significant	Moderate	No effect
RC @ Pin 7	Significant	Moderate	No effect
RC @ Pin 8	Moderate	Significant	No effect
RC @ Pin 11	No effect	Slight	Moderate
C @ Pin 12	No effect	Slight	Significant
RC @ Pin 13	No effect	Slight	Slight
RC @ Pin 23	No effect	Slight	Significant
V @ Pin 24	No effect	Moderate	No effect
C @ Pin 25	Moderate	Moderate	Slight

**N SUFFIX PLASTIC DIP  
(MS - 001AB)**

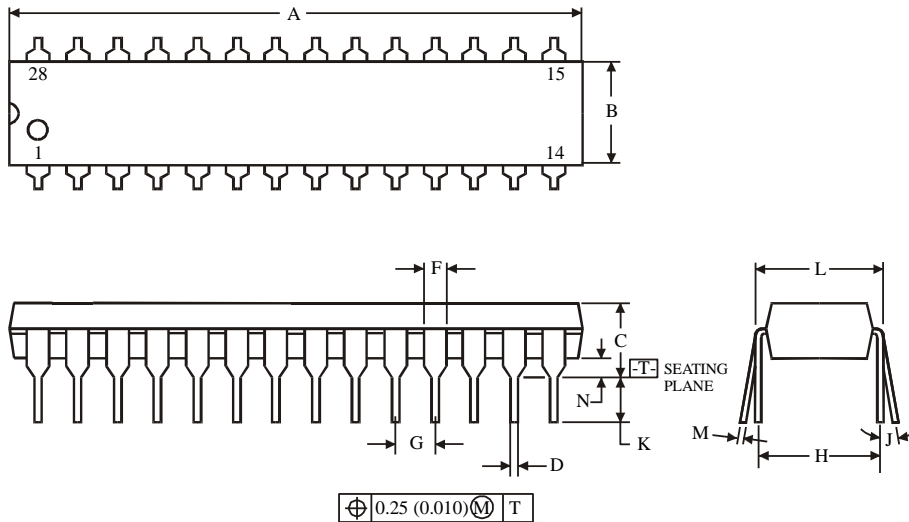
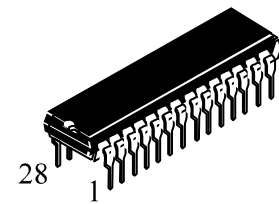

	Dimension, mm	
Symbol	MIN	MAX
A	35.10	39.70
B	12.32	14.73
C		6.35
D	0.36	0.56
F	0.77	1.78
G	2.54	
H	15.24	
J	0°	10°
K	2.92	5.08
L	15.24	15.87
M	0.20	0.38
N	0.38	

**NOTES:**

- Dimensions "A", "B" do not include mold flash or protrusions.  
Maximum mold flash or protrusions 0.25 mm (0.010) per side.

**D SUFFIX SOIC  
(MS - 059AD)**

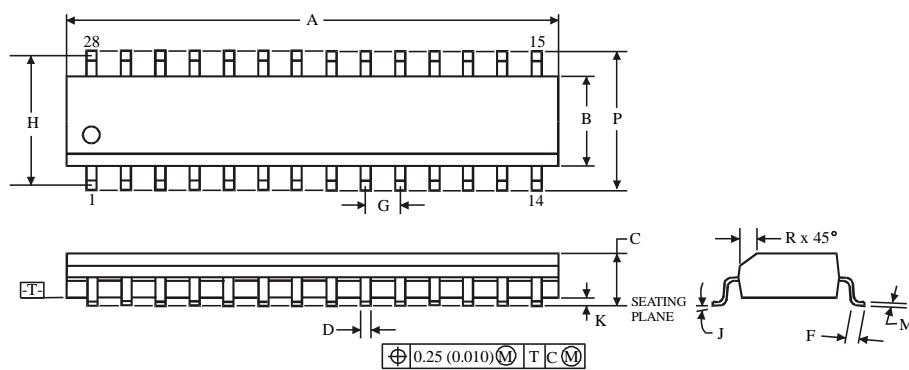
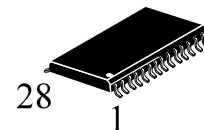

	Dimension, mm	
Symbol	MIN	MAX
A	17.70	18.50
B	7.40	7.60
C	2.35	3.05
D	0.35	0.50
F	0.40	1.27
G	1.27	
H	11.43	
J	0°	8°
K	0.05	0.35
M	0.14	0.32
P	10.00	10.65
R	0.25	0.75

**NOTES:**

- Dimensions A and B do not include mold flash or protrusion.
- Maximum mold flash or protrusion 0.15 mm (0.006) per side for A; for B - 0.25 mm (0.010) per side.